



The OPTOTRONIC programmable dimmable family consists of highly efficient, linear, constant current LED drivers. One click programming through the OPTOTRONIC programmer allows OEMs to configure the output current with 1mA resolution. Also fully customizable by customers are the end of life indicator, LED thermal protection and the constant lumen maintenance features. The OPTOTRONIC programmer does not require the driver to be powered up or connected to AC line voltage while programming. The power supplies are available with built-in 0-10V dimming protocol with models available in true 1% to 10%. The auxiliary output has the capability to power various sensors.

### Key Features & Benefits

- OEM Programmable with 1mA resolution to perfectly match LED load and maximize performance
- Integrated OEM programmable features include:
  - Constant lumen maintenance
  - End of life indication
  - LED thermal protection
  - Dim-to-off
  - Soft start
- Programming doesn't require powering up or connecting the driver to AC line voltage
- Specification grade dimming down to true 1% or 10% on 0-10V dimmers
- Available optional auxiliary output to power 12V, 20V, and 24V low power applications
- Slim form factors
- Input voltage:
  - Universal 120-277VAC 50/60Hz
  - 347VAC 50/60 Hz
- UL Class 2 output for safe operation

### Product Offering

Maximum Power	Minimum Dimming	Output Current Range
85W	1% 10%	700 - 2300mA
50W	1%	400 - 1400mA
48W	1%	700 - 2000mA
30W	1%	150 - 1050mA
20W	1%	150 - 700mA

### Configuration Overview



### Application Information

- Indirect/direct
- Linear
- Recessed troffer

### Specifications and Certifications



## Electrical Specifications

Maximum Output Power (W)	Nominal Input Voltage (V <sub>AC</sub> )	Maximum Input Current (A)	Power Factor	THD	Line Transient	Efficiency	Maximum Auxiliary Output Current (mA)	Auxiliary Output Voltage (V <sub>DC</sub> )*	Environmental Rating	UL File #
85W	120-277V <sub>AC</sub> 347-480V <sub>AC</sub> 50/60 Hz	0.83 @ 120V 0.28 @ 347V 0.21 @ 480V 0.36 @ 277V	>0.9	<20%	ANSI C62.41 Cat.A 2.5kV ANSI C82.77-5-2015 (6kV)**	>90%	40	12/20/24	Dry & Damp	E320395
50W	120-277V <sub>AC</sub> 347V <sub>AC</sub> 50/60 Hz	0.52 @ 120V 0.2A @ 347V 0.24 @ 277V	>0.9	<20%	ANSI C62.41 Cat.A 2.5kV	>90%	40	12/20/24	Dry & Damp	E320395
48W	120-277V <sub>AC</sub> 347V <sub>AC</sub> 50/60 Hz	0.52 @ 120V 0.2A @ 347V 0.23 @ 277V	>0.9	<20%	ANSI C62.41 Cat.A 2.5kV	>90%	40	12/20/24	Dry & Damp	E320395
30W	120-277V <sub>AC</sub> 347V <sub>AC</sub> 50/60 Hz	0.31 @ 120V 0.13 @ 347V 0.15 @ 277V	>0.9	<20%	ANSI C62.41 Cat.A 2.5kV	>87%	40	12/20/24	Dry & Damp	E320395
20W	120-277V <sub>AC</sub> 50/60 Hz	0.23 @ 120V 0.1 @ 277V	>0.9	<20%	ANSI C62.41 Cat.A 2.5kV	>87%	40	12/20/24	Dry & Damp	E320395

\*Default auxiliary output is 12V; configurable via OT Programmer

\*\* 6kV transient protection available for high-bay (HB) models only.

## Ordering Information

Item Number	NAED	Ordering Abbreviation	Total Output Power	Output Current Range	Default Current	Output Voltage Range (V <sub>DC</sub> )	Dimming Control	Dimming Range <sup>1</sup>	LED Thermal Protection
<b>Linear 120-277V Drivers</b>									
<b>OTi85</b>									
*2743W5	57420	OTi 85/120-277/2A3 DIM-1 L	85W	700-2300mA (programmable)	1400mA	10-55V	0-10V	1-100%	Yes
*2743W6	57421	OTi 85/120-277/2A3 DIM-1 L AUX	85W	700-2300mA (programmable)	1400mA	10-55V	0-10V	1-100%	Yes
*2743W7	57422	OTi 85/120-277/2A3 DIM-1 L	85W	700-2300mA (programmable)	1400mA	10-55V	0-10V	10-100%	Yes
*274A1R	57424	OTi 85/120-277/2A3 DIM-1 L HB	85W	700-2300mA (programmable)	1400mA	10-55V	0-10V	1-100%	Yes
*274A1S	57425	OTi 85/120-277/2A3 DIM-1 L HB AUX	85W	700-2300mA (programmable)	1400mA	10-55V	0-10V	1-100%	Yes
*274A1T	57426	OTi 85/120-277/2A3 DIM-1 L HB	85W	700-2300mA (programmable)	1400mA	10-55V	0-10V	10-100%	Yes
<b>OTi50</b>									
*2743X7	57456	OTi 50/120-277/1A4 DIM-1 L AUX G2	50W	400-1400mA (programmable)	1050mA	10-55V	0-10V	1-100%	Yes
*2743X3	57452	OTi 50/120-277/1A4 DIM-1 L G2	50W	400-1400mA (programmable)	1050mA	10-55V	0-10V	1-100%	Yes
<b>OTi48</b>									
*2743X6	57455	OTi 48/120-277/2A0 DIM-1 L AUX G2	48W	700-2000mA (programmable)	1400mA	10-55V	0-10V	1-100%	Yes
*2743WH	57434	OTi 48/120-277/2A0 DIM-1 L G2	48W	700-2000mA (programmable)	1400mA	10-55V	0-10V	1-100%	Yes
<b>OTi30</b>									
*2743X5	57454	OTi 30/120-277/1A0 DIM-1 L AUX G2	30W	150-1050mA (programmable)	700mA	10-55V	0-10V	1-100%	Yes
*2743WG	57433	OTi 30/120-277/1A0 DIM-1 L G2	30W	150-1050mA (programmable)	700mA	10-55V	0-10V	1-100%	Yes
<b>OTi20</b>									
*2743X4	57453	OTi 20/120-277/0A7 DIM-1 L AUX G2	20W	150-700mA (programmable)	350mA	10-55V	0-10V	1-100%	Yes
*2743WE	57431	OTi 20/120-277/0A7 DIM-1 L G2	20W	150-700mA (programmable)	350mA	10-55V	0-10V	1-100%	Yes
<b>Linear 347-480V Drivers</b>									
<b>OTi85</b>									
*2743W9	57428	OTi 85/347-480/2A3 DIM-1 L HB	85W	700-2300mA (programmable)	1400mA	10-55V	0-10V	1-100%	Yes
*2743WA	57429	OTi 85/347-480/2A3 DIM-1 L HB AUX	85W	700-2300mA (programmable)	1400mA	10-55V	0-10V	1-100%	Yes
*2743WC	57430	OTi 85/347-480/2A3 DIM L HB	85W	700-2300mA (programmable)	1400mA	10-55V	0-10V	10-100%	Yes
<b>OTi50</b>									
*2743YU	79670	OTi 50/347/1A4 DIM-1 L AUX	50W	400-1400mA (programmable)	1050mA	10-55V	0-10V	1-100%	Yes
*2743YX	79676	OTi 50/347/1A4 DIM-1 L	50W	400-1400mA (programmable)	1050mA	10-55V	0-10V	1-100%	Yes
*27440A	79678	OTi 50/347/1A4 DIM L	50W	400-1400mA (programmable)	1050mA	10-55V	0-10V	10-100%	Yes
<b>OTi48</b>									
*2743YV	79671	OTi 48/347/2A0 DIM-1 L AUX	48W	700-2000mA (programmable)	1400mA	10-55V	0-10V	1-100%	Yes
*2743YY	79677	OTi 48/347/2A0 DIM-1 L	48W	700-2000mA (programmable)	1400mA	10-55V	0-10V	1-100%	Yes
*27440E	79680	OTi 48/347/2A0 DIM L	48W	700-2000mA (programmable)	1400mA	10-55V	0-10V	10-100%	Yes
<b>OTi30</b>									
*2743YT	79669	OTi 30/347/1A0 DIM-1 L AUX	30W	150-1050mA (programmable)	700mA	10-55V	0-10V	1-100%	Yes
*2743YW	79675	OTi 30/347/1A0 DIM-1 L	30W	150-1050mA (programmable)	700mA	10-55V	0-10V	1-100%	Yes
*27440C	79679	OTi 30/347/1A0 DIM L	30W	350-1050mA (programmable)	700mA	10-55V	0-10V	10-100%	Yes

1. Dim-to-off and Soft-start are programmable (enable/disable) features. The default mode for both features is disabled for out-of-the-box products.

## Ordering Guide

OTi	85	/	120-277	/	2A3	DIM	L	HB	AUX	G2
OPTOTRONIC® Intelligent	Output Wattage		Input Voltage		Output Current (Max)	0-10V Dimming	L = Linear	HB = Highbay	AUX = Auxiliary Output	Gen2
	85 = 85W		120-277		2A3 = 2300mA	DIM = 10% Dimming				
	50 = 50W		347		1A4 = 1400mA	DIM-1 = 1% Dimming				
	48 = 48W		347-480		1A0 = 1000mA					
	30 = 30W				0A7 = 700mA					
	20 = 20W									

## Accessories



Item Number	NAED	Ordering Abbreviation	Description	Required Accessory
*274A17	51645	OT Programmer	USB Programming Tool	Yes
*2747CR	51647	OTLinearHandheldPRGtool	Programming Tool	No
*2743V1	51648	OTLinearAutoPRGTool	Programming Tool	No

## Minimum and Maximum Ratings

Parameter	Values
Input Voltage Range	108 - 305V <sub>AC</sub> (UNV); 312-528V <sub>AC</sub> (High Voltage [HV])
Maximum Case Temperature (T <sub>c</sub> point)	90°C (194°F) for 85W, 85°C for 20/30/48/50W
Maximum Case Temperature for 5 year life and warranty	75°C (176°F) for 20/30/48/50W and 85°C for 85W
Ambient Operating Temperature (reference)	-30°C to 50°C (-22°F to 122°F) for 20W-50W -40°C to 55°C (-40°F to 131°F) for 85W
Storage Temperature	70°C Max (150°F)
Maximum Relative Humidity	85% (Non-condensing)

## Assembly Diagram

### OTi20W, OTi30W, OTi48W and OTi50W

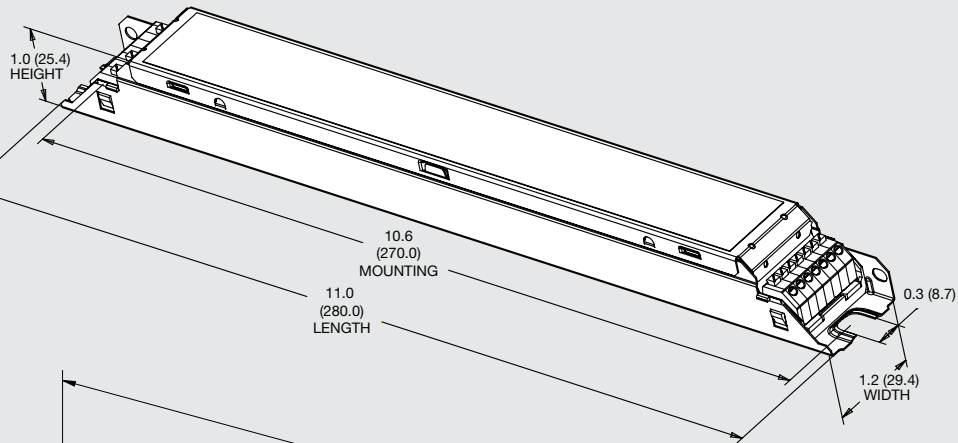

### OTi85W

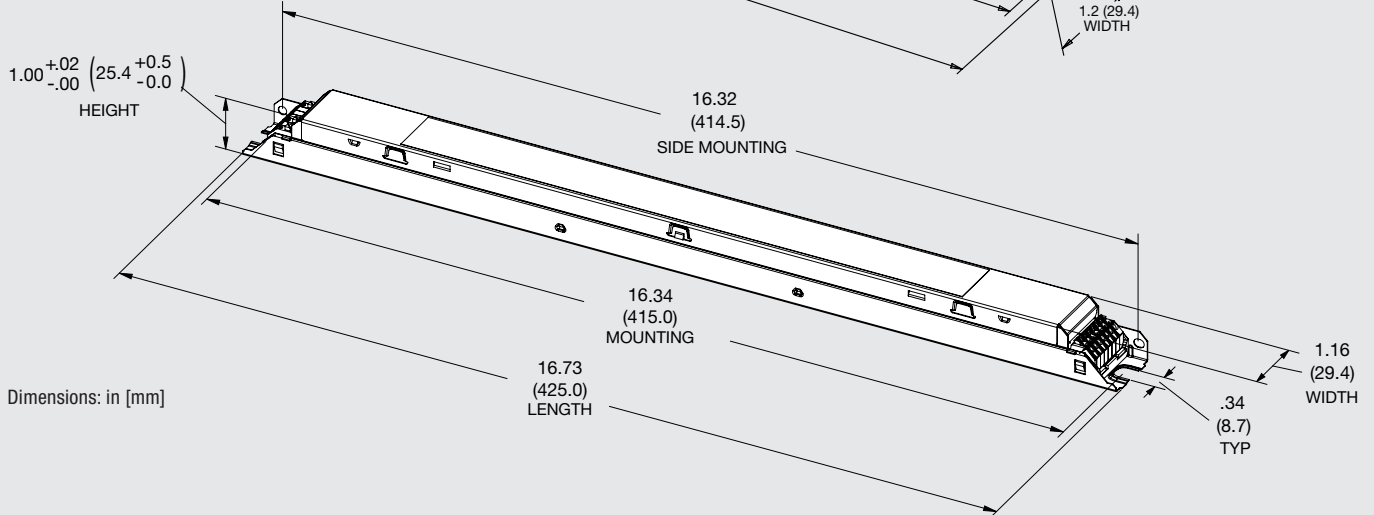

Dimensions: in [mm]

## Wiring Diagram

### AUX output models

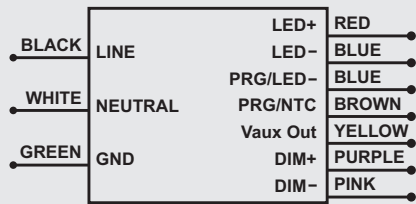

### non-AUX output models

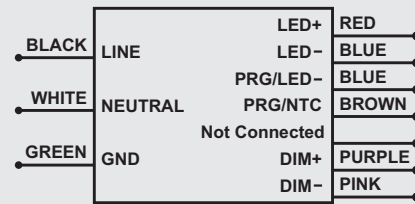

### 85W (347-480) w/AUX

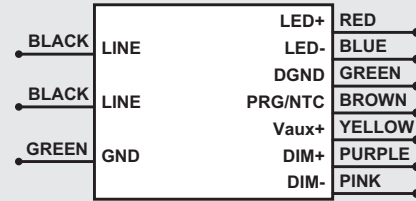

### 85W (347-480) w/o AUX

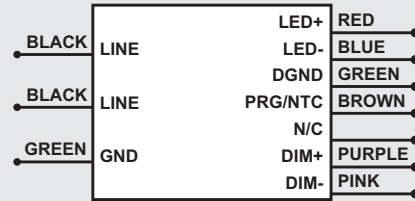

## Operating Range

OTi20W

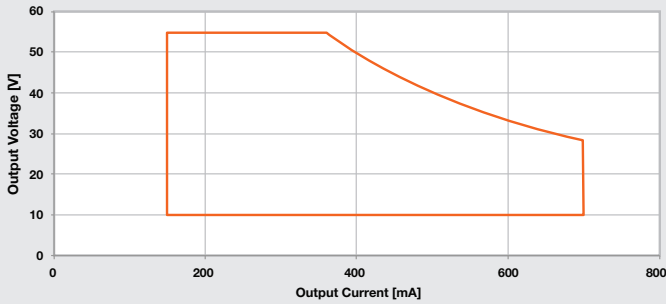

OTi30W

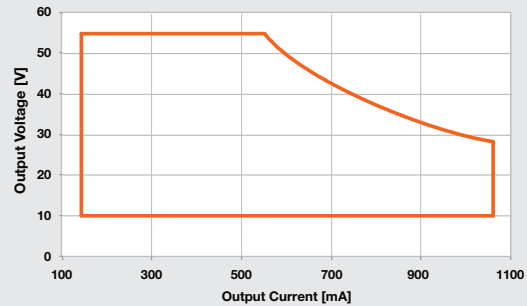

OTi48W

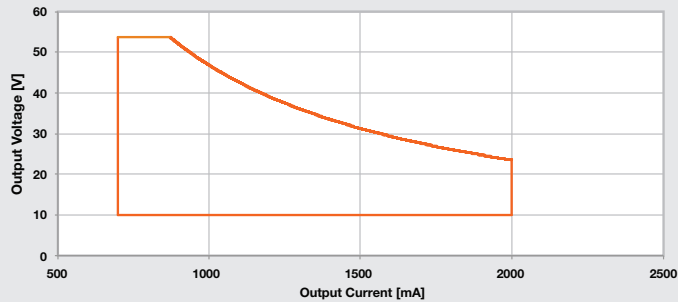

OTi50W

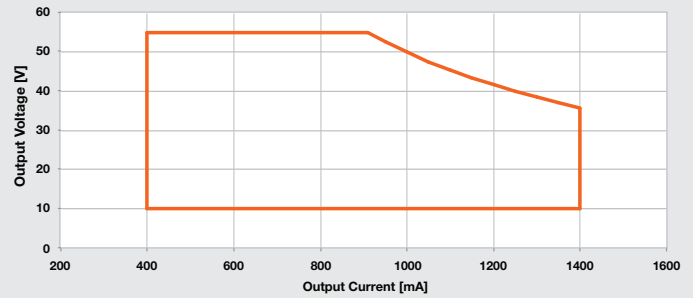

OTi85W

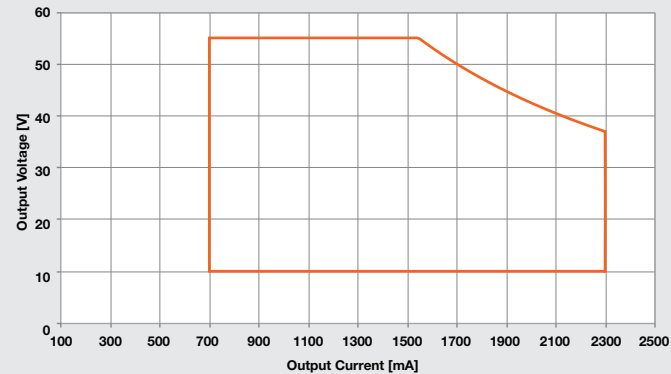

---

## Packaging

OTi20W, OTi30W, OTi48W, and OTi50W

Quantity: 10 pieces per case

Weight: 0.5 lbs ea./5 lbs per case (approx.)

OTi85W

Quantity: 10 pieces per case

Weight: 0.904 lbs ea./9.04 lbs per case (approx.)

---

## Warranty

eldoLED OPTOTRONIC® Products are covered by a 5-year limited warranty. Complete warranty terms can be found at:  
<https://www.eldoled.com/legal/terms-and-conditions>

### eldoLED

One Lithonia Way  
Conyers, GA 30012  
United States

+1 877 353 6533

[nasupport@eldoLED.com](mailto:nasupport@eldoLED.com)

[www.eldoLED.com](http://www.eldoLED.com)

©2021 Acuity Brands Lighting, Inc.

Specifications subject to change without notice. Actual performance may differ as a result of end-user environment and application.