

ASSEMBLY INSTRUCTIONS

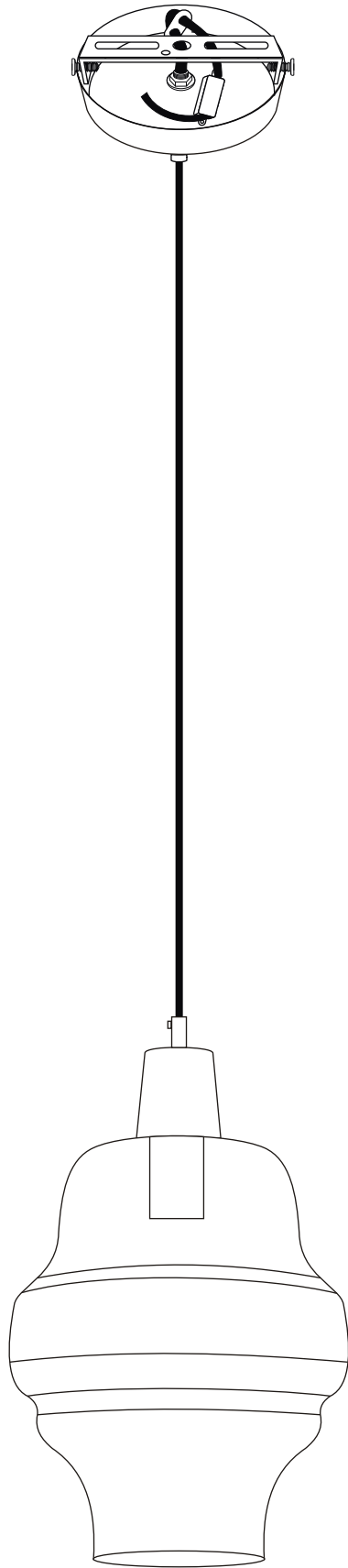

STEP 1

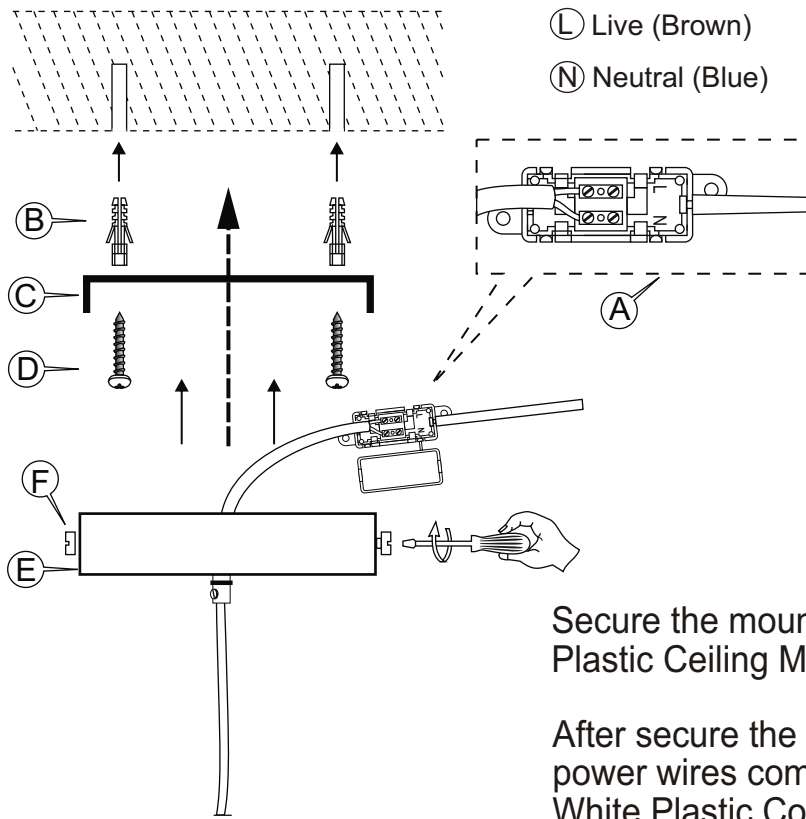

Secure the mounting plate (C) with screw (D) in the Plastic Ceiling Mounts (B).

After secure the mounting plate, Connect the two power wires coming out from the ceiling to the White Plastic Connector (A).

STEP 2

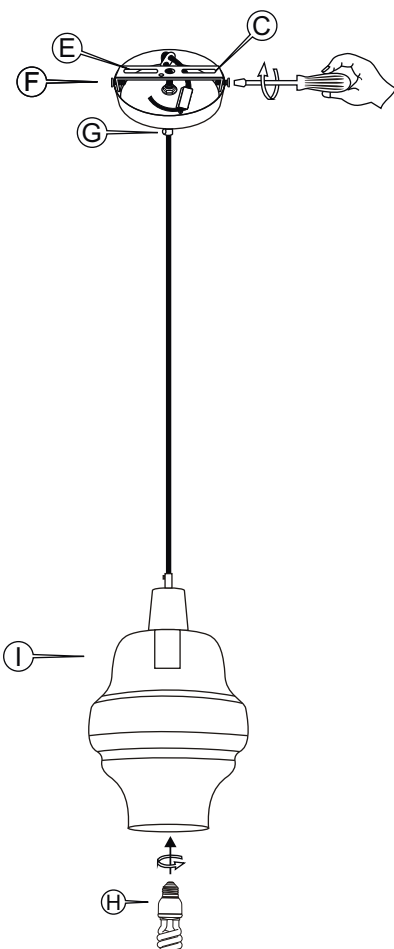

Tighten the canopy (E) with side Screw (F) to the mounting plate (C) and tighten the screw on plastic cord grip (G)

Secure the Light Bulb (H) / E27 into the Plastic Lamp Holder (I)

To prevent the risk of fire, do not use bulb with wattage greater than 13W CFL, 15W LED & 25W Regular Bulb.

MOUNTING INSTRUCTIONS:

* THIS LUMINAIRE SHOULD BE ASSEMBLED AND MOUNTED BY A QUALIFIED ELECTRICIAN ONLY

* IF THE EXTERNAL FLEXIBLE CABLE OR CORD OF THIS LUMINAIRE NEEDS TO BE CHANGED IT SHOULD BE REPLACED BY A QUALIFIED ELECTRICIAN.