

TABLE MALAYA









Read instruction carefully. Refer hardware and furniture parts list for guidance. Be sure all parts are complete. Before assembling, place all wooden furniture part on a clean and flat soft surface to prevent scratches. refer steps provided as assembling guide.

CAUTION :

1. Do not FULLY-TIGHTEN the nuts or bolts until all are in place.
2. To prevent thread damage, ensure that nuts or bolts are not over tighten.
3. Hardware are to be kept out reach from children.

PART LIST

HARDWARE LIST

ITEM	DESCRIPTION	QTY	ITEM	DESCRIPTION	QTY
1	TABLE TOP	1 PC	A	JCBC SCREW M6 x 60MM 	2 PCS
2	TABLE LEG	2 SETS	B	JCBC SCREW M6 x 30MM 	16 PCS
3	TABLE LEG SUPPORTER	2 PCS	C	SPRING WASHER 	18 PCS
			D	ALLEN KEY M4 (BALL SHAPE) 	1 PC
			E	WOOD BUTTON 	2 PCS
			F	ADJUSTABLE SCREW 	4 PCS

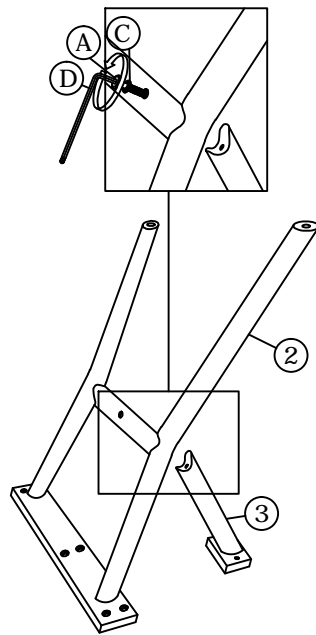

STEP 1

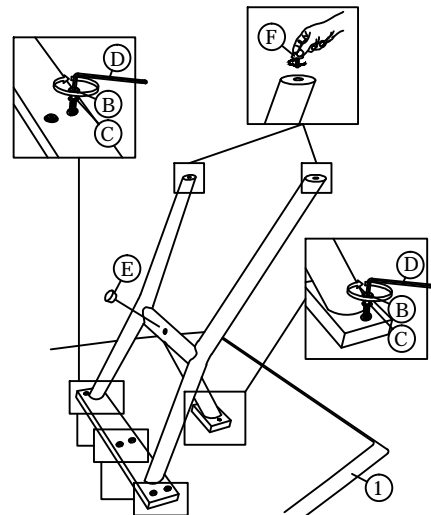

STEP 2

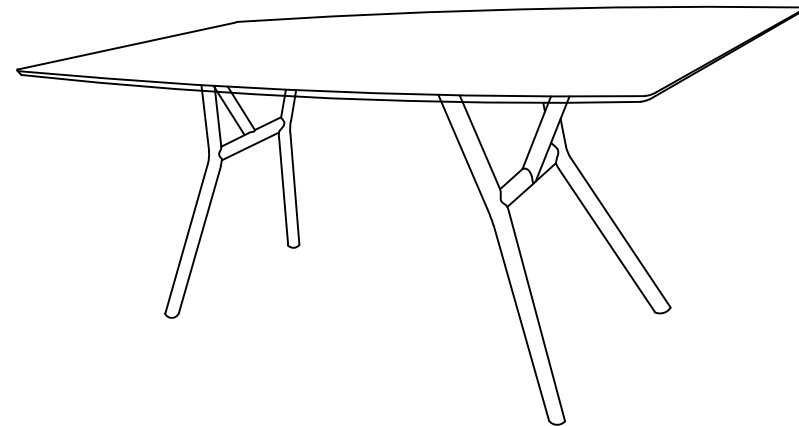

COMPLETED ASSEMBLY