

Button-Up Café Curtains

A ready-made dish towel plus an easy to make button-up topper creates a window accessory with pizzazz! Enhance further with your choice of embellishments.

Finished size: panels approximately 18½" x 30" each

Supplies needed: (Makes two panels)

- ⅔ yd. Fabric A (button bands)
- ⅔ yd. Fabric B (button band facings)
- ⅓ yd. Fabric C (contrast piping)
- One flour sack towel, 32" x 36"
- Fourteen ¾" basic buttons (tabs)

Helpful notions:

- Pattern tracing paper
- Erasable fabric marking pen or pencil
- Bamboo Pointer & Creaser
- Matching all-purpose thread

Instructions: (read all instructions before beginning)

Note: All seam allowances are ¼", unless noted otherwise.

1. Create paper patterns:

sewing with nancy hint The café curtain button band and facing (end section) pattern pieces, on pages 4 through 7, are tiled. Copy the patterns and tape them together, matching tile marks, to obtain full size patterns before proceeding.

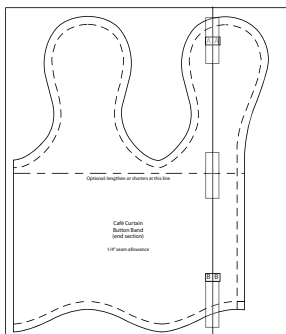

- Trace one café curtain button band end section and one mirror-imaged end section. Be sure to trace all markings.
- Trace three café curtain button band middle sections, including all markings.

Designer Notes:

- Notice the optional lengthen/shorten lines on each segment; use these for alignment in this project. In future curtain projects you may wish to customize the button band to a larger or smaller curtain rod. Cut the pattern apart on the lengthen/shorten lines and spread the two sections apart equally to lengthen the band or overlap the two sections equally to shorten the band.
- Use three middle sections for this project. Customize future projects by adding or subtracting middle sections.
- Tape the traced sections together, placing an end section at opposite edges of the combined middle sections. Use a straight edge aligned with lengthen/shorten lines to ensure that the sections are accurately aligned (see illustration.)

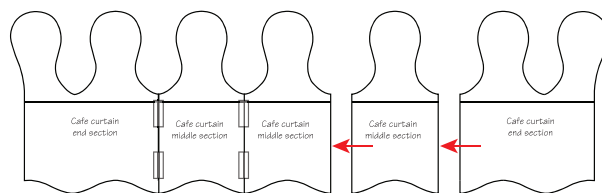

- Repeat process described above to create the café curtain button band facing pattern. The pattern is similar except the facing has a straight lower edge.

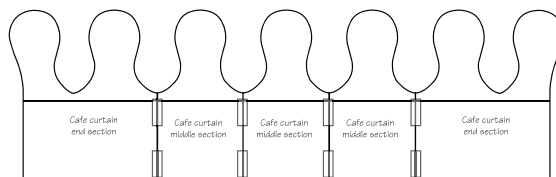

2. Cut fabrics for the café curtains:

- Fabric A: Cut two button bands using pattern.
- Fabric B: Cut two button band facings using pattern.
- Fabric C: Cut five or six 1" wide bias strips (piping trim).

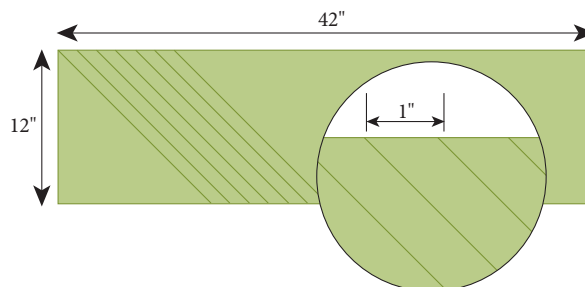

3. Assemble the button band:

- Prepare the button band components. Transfer markings from the lower edge of facing pattern onto Fabric B facings, using an erasable fabric marking pen or pencil
- Staystitch a **scant** ¼" from the lower wavy edge of the button band through a single thickness to keep it from stretching out of shape.

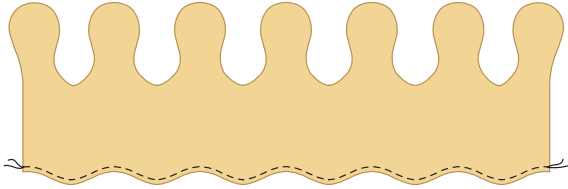

• Optional: Add piping trim.

- Join 1" wide bias strips on the diagonal, right sides together, to reduce bulk. Trim seam allowance to ¼"; press seam open. Join enough strips to equal a 68"-72" length (or two 36" lengths).
- Press the seamed strip in half, meeting long edges, wrong sides together.
- Align cut edges of piping and wavy lower edge of button band, right sides together.
- Baste the piping to the band using a **scant** ¼" seam allowance. Stretch the bias trim slightly at the inner curves and ease the trim along the outer curves.

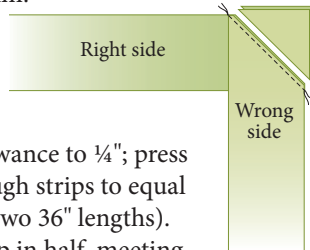

- Clip and notch the curved seam allowances along the stitched edge.

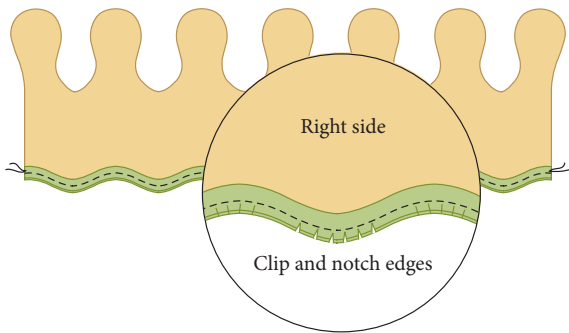

- Press the seam up along the clipped and notched seam allowance.

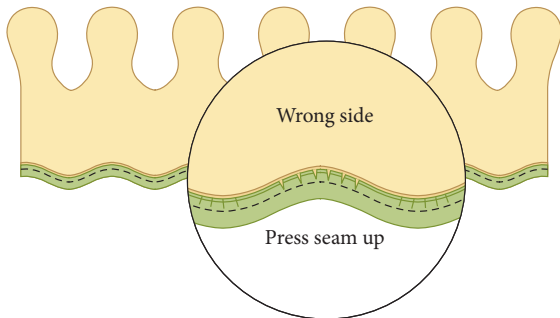

- Align the button band to the button band facing, right sides together. Pin layers together.
- Stitch the sides and upper button tab edge, locking stitches at the folded edge of the pressed-up hem.

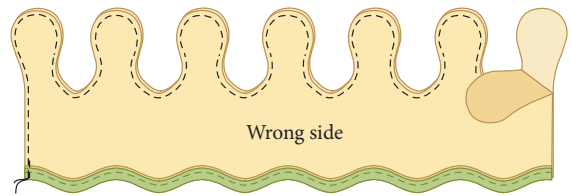

- Clip and notch the curved seam allowances.
- Press flat, then turn band to right side. Use a Bamboo Pointer & Creaser to gently shape each button tab.
- Press the turned edges.

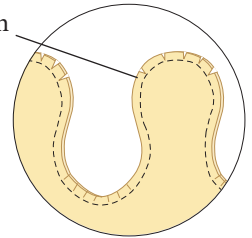

4. Prepare the curtain panels:

- Fold one flour sack towel in half, meeting longer cut edges.
- Cut along the foldline, yielding two rectangles, approximately 16" x 36".

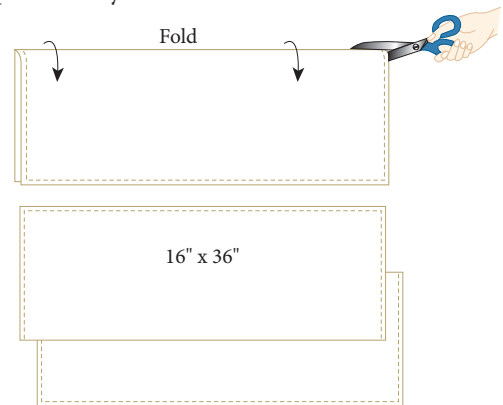

- Optional: Add embellishment along the lower hem edges.



Designs from Amazing Designs® Garden of Plenty Embroidery Designs by Sewing With Nancy®

- Mark the upper cut edge of each panel, using an erasable fabric marking pen or pencil.
 - Place a mark at center and $\frac{1}{2}$ " in from each outer edge.

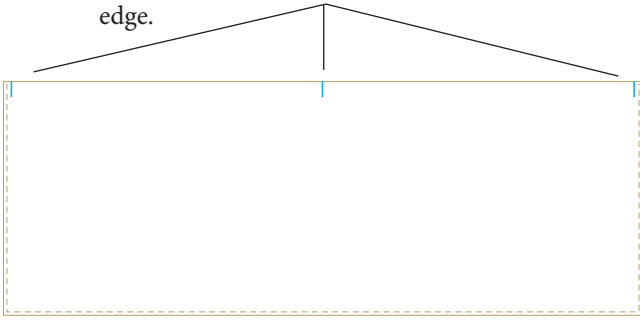

- Add two additional marks, spaced equally (approximately $5\frac{3}{4}$ " to 6" apart) between center and outer edges marks.

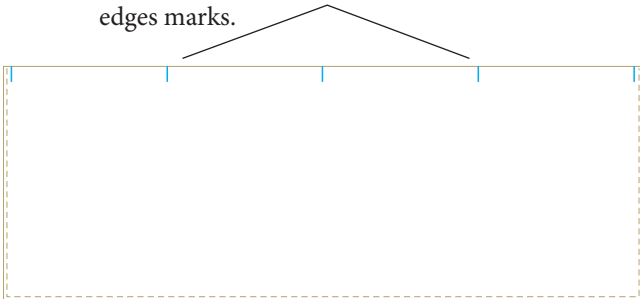

- Create tucks along marked edge.
 - Fold and pin two approximately $\frac{1}{4}$ " deep tucks at center front, folding tucks toward the center.
 - Fold and pin one approximately $\frac{1}{4}$ " deep tuck at each of the remaining marks, folding tucks toward outer edges.

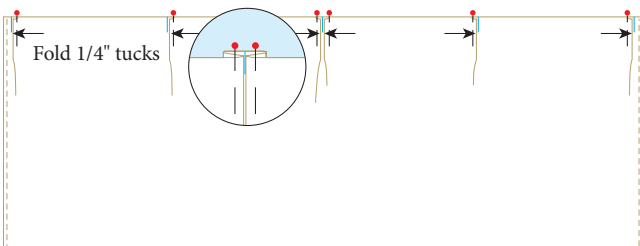

- Test fit the pinned curtain panel to the button band facing, matching pleats to markings on button band facing. Adjust the depth of the pleats as necessary to perfect the fit; repin. Baste pleats in place.

5. Finish the café curtains:

- Meet the wrong side of curtain panel to the right side of button band facing, aligning cut edges. Pin and stitch together.

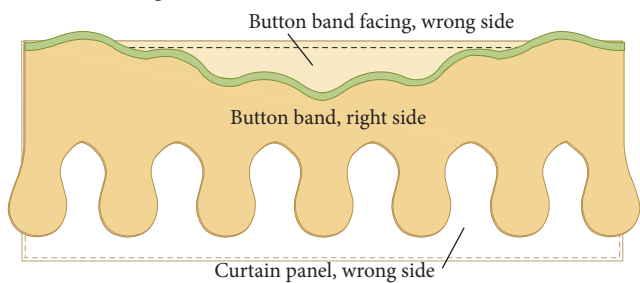

- Press seam flat, then press seam allowance toward the button band facing.
- Bring the pressed wavy edge of the button band over the front of the curtain panel, tucking the curtain seam allowance under the wavy edge.
- Edgestitch along the wavy edge of the button band, stitching through all layers.

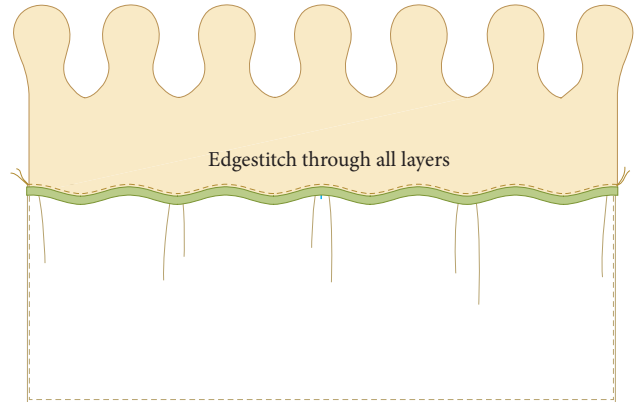

- Stitch buttonholes as marked on each tab.

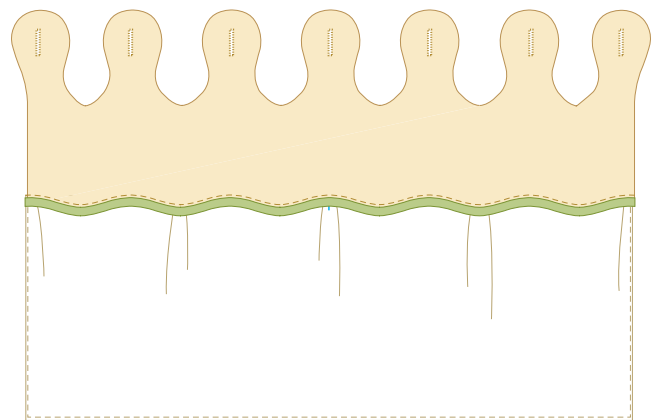

- Bring tabs over lower edge of the button band; pin in place and mark for button placement. Sew buttons to the band.

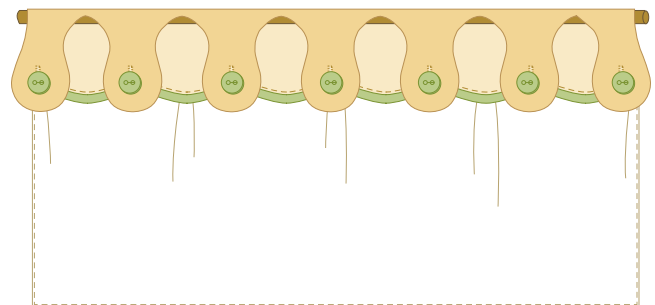

Button-Up Option: Skip making buttonholes! Simply pin the tabs in the desired location and sew on the buttons through all layers. Hang in your window and enjoy!

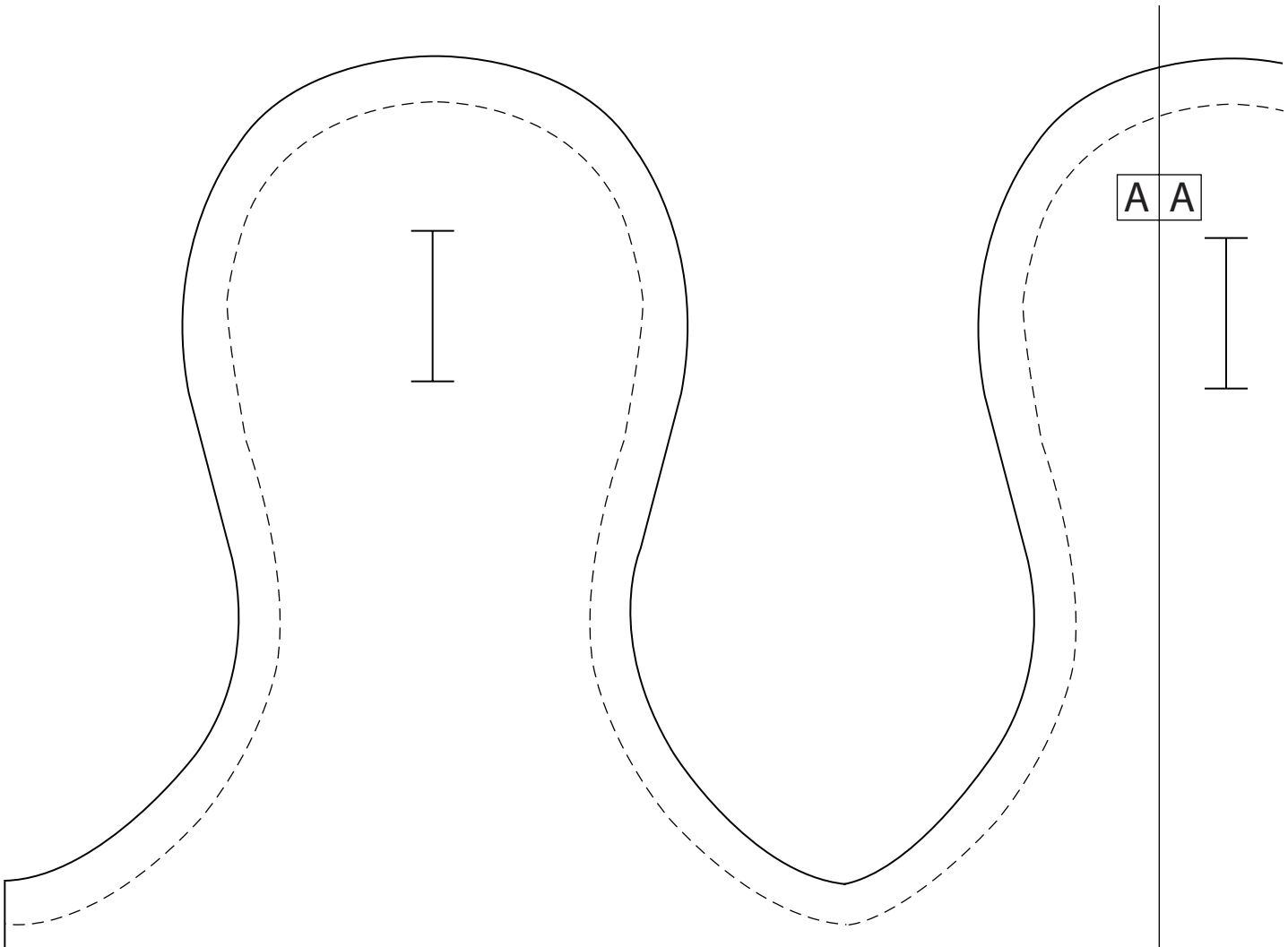

Optional: lengthen or shorten at this line

Café Curtain
Button Band Facing
(end section)

1/4" seam allowance

B B

Mark

Mark

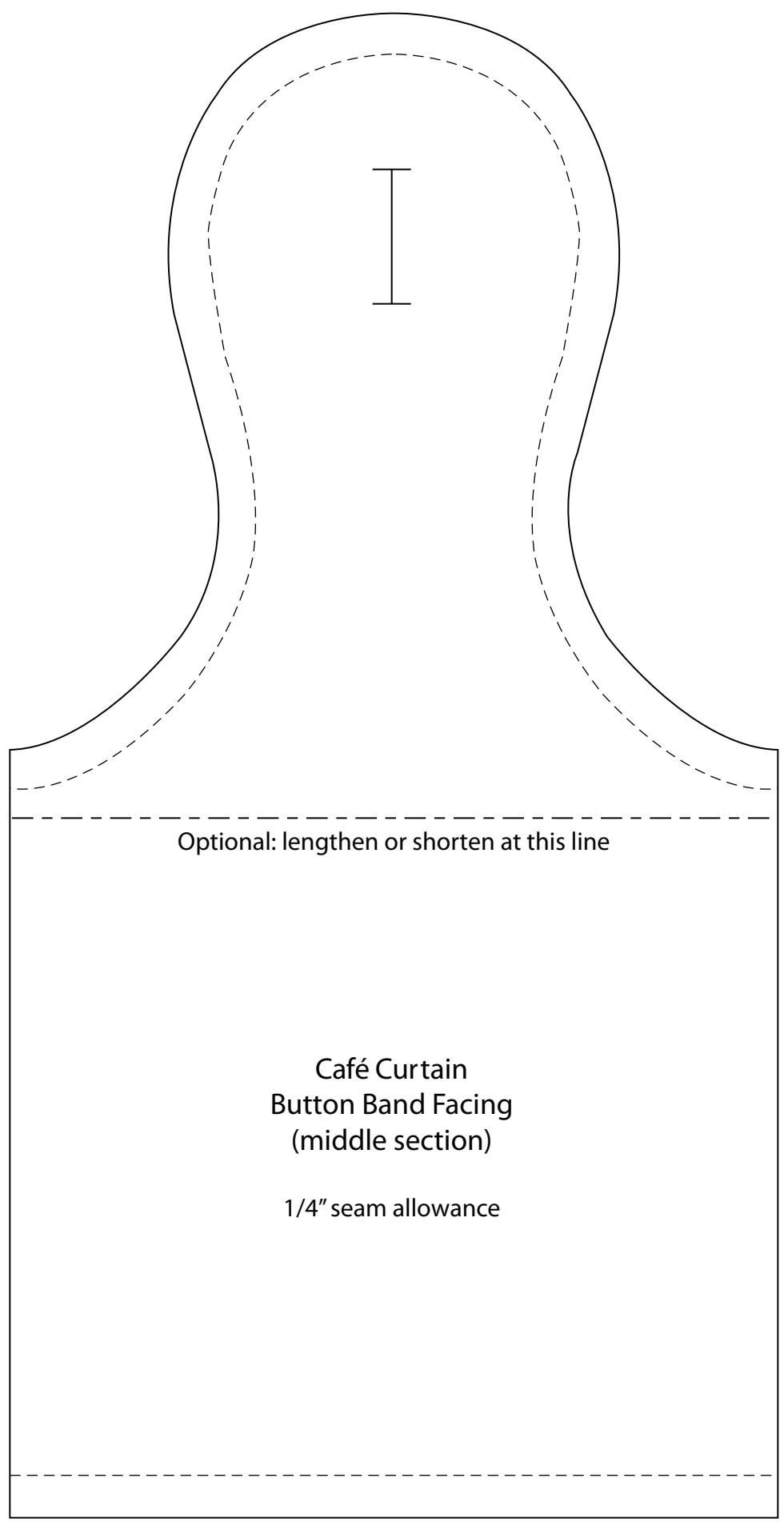
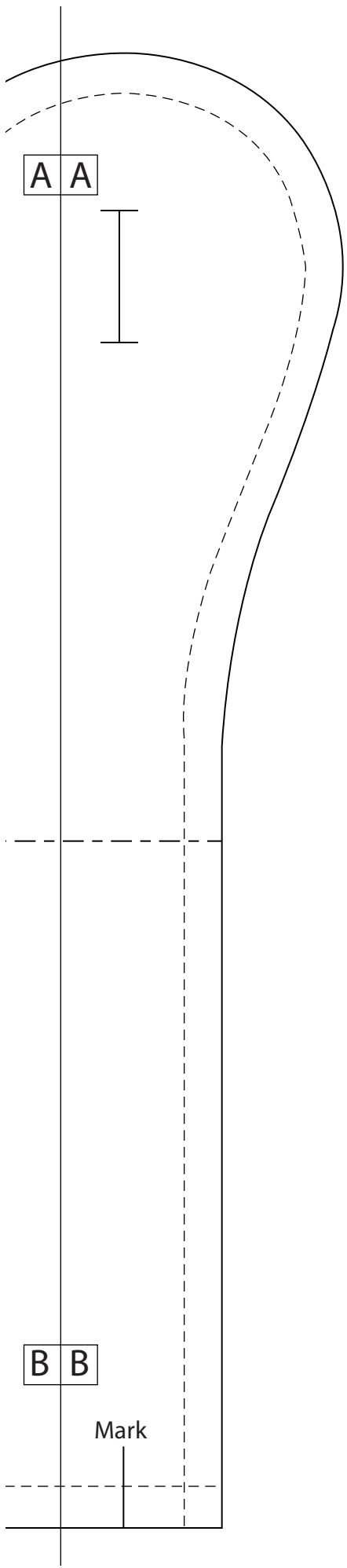

Café Curtain
 Button Band Facing
 (middle section)

1/4" seam allowance

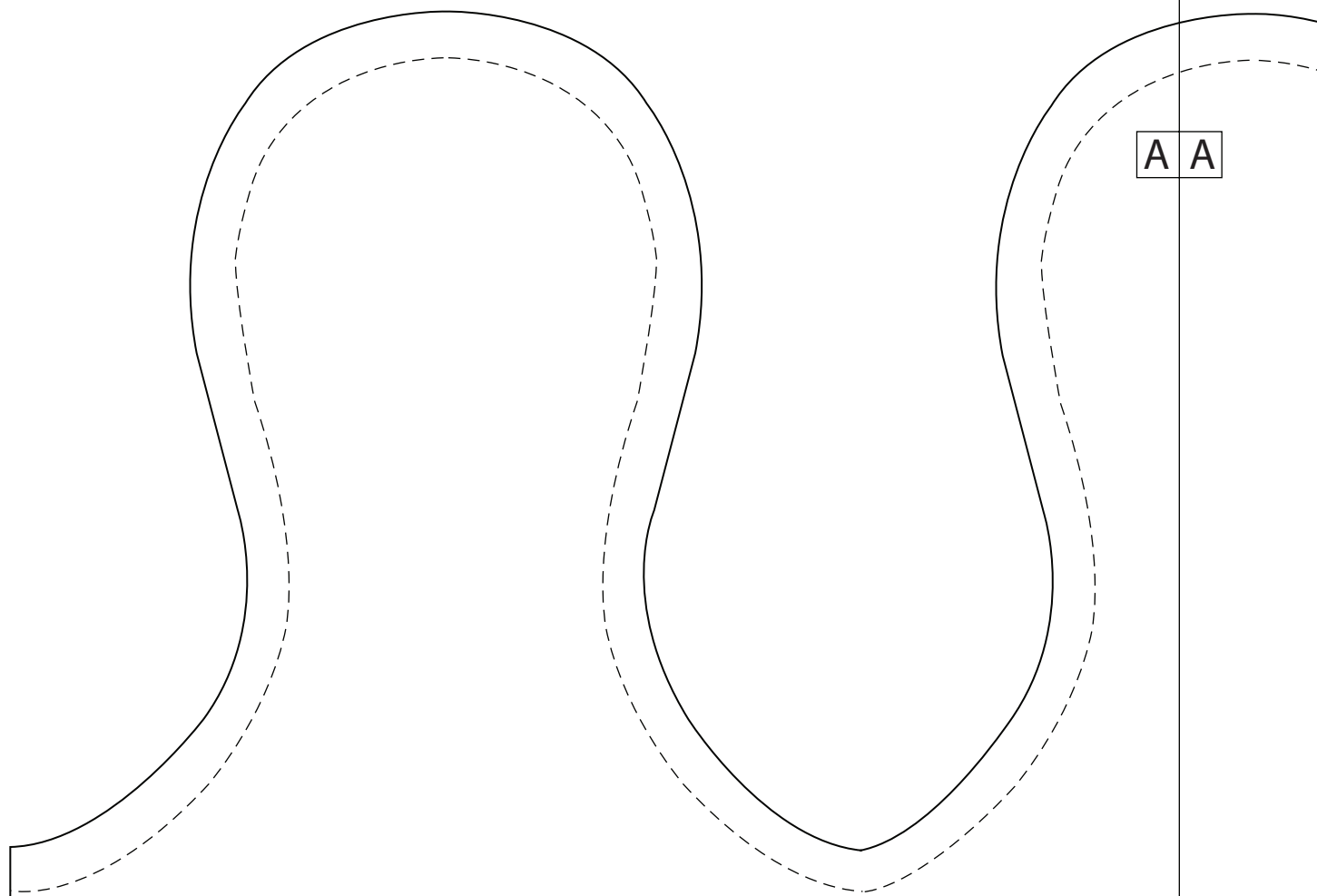

Optional: lengthen or shorten at this line

Café Curtain
Button Band
(end section)

1/4" seam allowance

A A

B B

6

A A

B B

Optional: lengthen or shorten at this line

Café Curtain
Button Band
(middle section)

1/4" seam allowance