

LS-RW6024-5C20

RGB+W Double Density Indoor 24V LED Strip

Introduction

The LS-RW6024-5C20 RGB+W 24V LED Strip uses 5050 SMD LED modules with high temperature resistant flexible FPC technology. This cuttable strip has a 3M adhesive back with ultra-thin design, so it is easy to install in all kinds of spaces. It is ideal for hotels, retail locations, residences, and or all places in need of energy efficient and accent lighting.

Specifications

- Input Current 3A
- Output Power 72W
- Viewing Angle 120°
- Operating Temperature -4-113°F
- Storage Temperature -4-140°F
- Relative Humidity 40-70% noncondensing
- Lifetime Mean time between failure (MTBF) is 50-100K hours
- Length 16 ft. 4 in. per roll
- Weatherproof Rating IP67
- Safety Certifications CE, RoHS and ISO9001 listed



Performance and Parameters

Color	Color Temperature	Luminous Flux	Quantity of LEDs/m	LED Type
RED	620-630	18-20 lumens	60	5050 SMD
Green	460-470			
Blue	515-525			
White	5500-7000K			

Note:

- (1) Tolerance of luminous flux is $\pm 10\%$.
- (2) Photometric standards are based on CIE eye sensitivity curve diagram test.

Dimensions

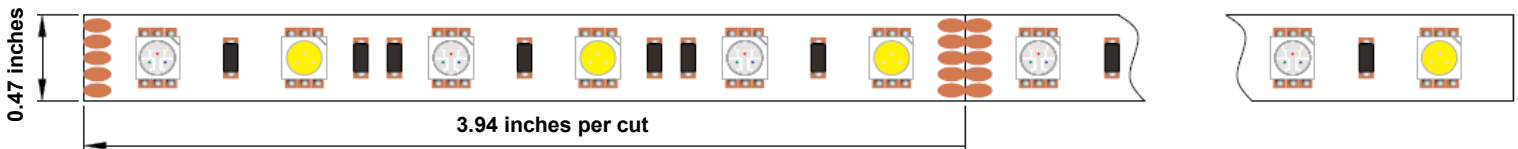

LS-RW6024-5C20

RGB+W Double Density Indoor 24V LED Strip

RGB+W Double Density
Indoor 24V LED Strip

LS-RW6024-5C20

Connection Diagram

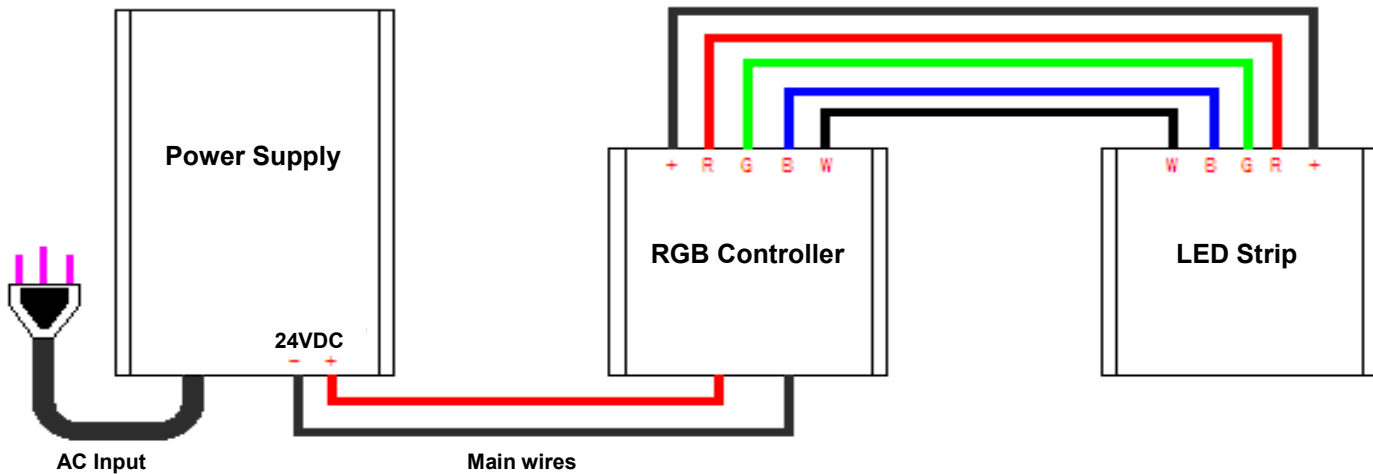

Note: For consistent brightness and even appearance, we recommend you to connect the LED strips to a power supply or repeater every 20-30 ft. to minimize voltage drop.

Installation

Problem	Cause	Solution
No LED modules are on	No power is being supplied.	Check the connections and power supply.
	Power supply is shorted and short-circuit protection is on.	Fix the shorted power supply or replace the power supply.
Some LED modules are on, but some are not.	Not enough power is being supplied.	Check the power supply or upgrade to a higher wattage power supply.
	Power connection is not good.	Check the power connection wiring from the power supply.
	Too much static electricity around the strip.	Check all electronics around the strip and make them grounded or replace the LED strip.
The brightness of the LED modules are different.	Loss of power due to voltage drop.	Use lower gauge (AWG) wiring or bring the power supply closer to the strip to alleviate voltage drop.
	Power supply is overloaded.	Check the power supply.
	Polarity of LED strip reversed.	Check the wiring connection.
LED modules appear to flash unevenly.	Poor Wiring connections.	Rewrite the connection to the LED Strip.

WARNING: DO NOT FOLD OR BEND THE LED STRIP. USE APPROPRIATE CONNECTORS AND WIRIN INSTEAD!!!