

# Ultra Long Standby Wi-Fi Security Camera with Low Power Consumption

## User Manual

Version: August, 2021

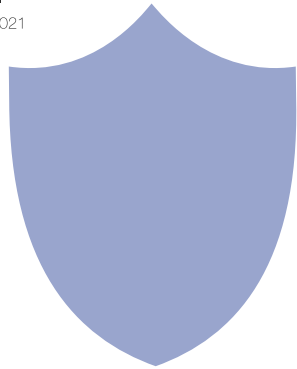

Size: 65x37x107mm



### Quick guide of Wi-Fi camera function:

1. Download & Install Free App <CamSC> from App Store or Google Play;

**Tips:** Please allow "CamSC" to notification, Bluetooth and location while using the App.

2. Enter App, select your region at the top right corner and register;

**Tips:** If a code doesn't arrive, please check the spam folder first.

3. Take off back cover --> Insert micro SD card --> Turn back ON/OFF switch, press reset key 4 seconds till a beep sound (Pairing mode is ready now).

4. Enter App, Click + >> Smart Home >> Pairing Mode >> Click device name >> Select Wi-Fi >> Input password > NEXT.

5. Device online in around 10 seconds & Wi-Fi live video is ready.

P.S.: Contact local dealer for tutorial video setting up.

### Overview:

The Ultra Long Standby WiFi Security Camera, it is built with high tech of super low power consumption 450µA/hour to save energy for around 1 year standby after being fully charged.

First, it can be used for watching live streaming video day and night (night vision around 5 meters), or taking photo and video by APP in smart-phone remotely after WiFi connected;

Second, its PIR sensor will make precisely motion detect recording for surveillance use (around 5 meters distance and 2 meters height) . Also, it has cycle recording and work when charging.

**Usages:** Nanny camera, Home/ Shop/ Office/ Warehouse surveillance camera.....

**Warning :** " illegal use is not allowed! Or, there will be consequences to bear! "

### In the box:

1 x Camera Unit    1 x Micro SD Card Reader    1 x User Manual  
1 x USB Cable    1 x Bracket Accessories

### Product structure

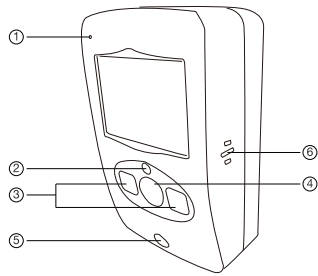

- ① Microphone    ② Light sensor    ③ Invisible night vision leds
- ④ Camera    ⑤ PIR sensor    ⑥ Camera speaker

3

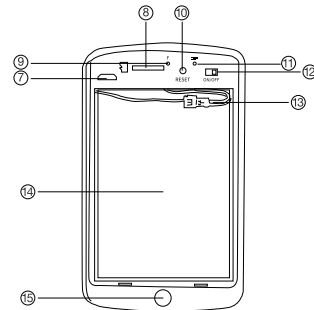

- ⑦ USB charging port    ⑧ WiFi indicator
- ⑨ WiFi indicator    ⑩ Reset key
- ⑪ Charging indicator    ⑫ ON/OFF switch
- ⑬ Battery connect part    ⑭ Battery
- ⑮ Bracket connect part

4

2. Open APP CamSC, select current region at the top right corner. Register with email, or third-party account like Facebook or IOS account. (Tips: If a code doesn't arrive, please check the spam folder first.)

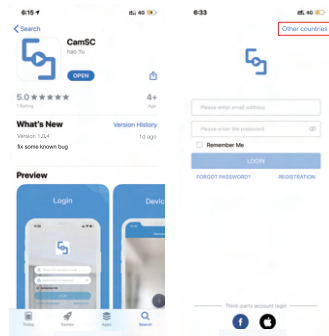

Step 2: Take off back cover --> Insert micro SD card --> Turn back ON/OFF switch (WiFi indicator is solid blue);

7

Step 3: Connect WiFi

1. Press Reset key 4 seconds till a beep sound (WiFi indicator blink slowly and ready for pairing WiFi);  
2. Open APP CamSC >> Click + >> Smart Home >> Device in pairing mode >> CAM-xxxxxx.

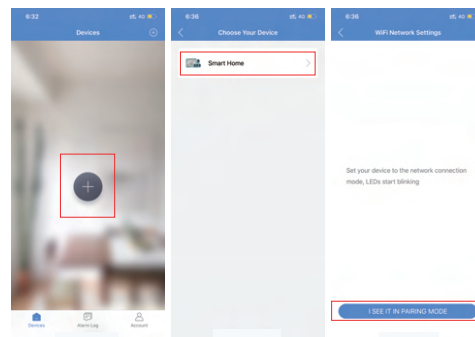

8

### Reset key tips:

One press to restart device;  
4 seconds press to pair with WiFi (First double beep);  
6 seconds press to reset device (Second double beep).

### Wi-Fi indicator tips:

Blue LED blinking when pairing with WiFi;  
Turn off when WiFi paired;  
Blink once when motion detected.

### Charging indicator tips:

Solid red when charging, and off when fully charged.

1

3. Click > at the end of WiFi to select the local router WiFi, then input password.  
Click NEXT and wait around 10 seconds to finish the configuring; Device Binding Successful and online now.

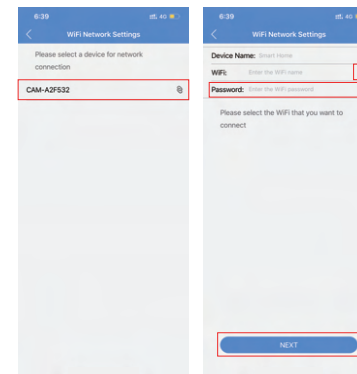

9

### Wi-Fi Camera Connection Setting

Step1: CamSC APP

1. Scan below QR code or search and download free APP named <CamSC> in Apple APP store, Google play or Electronic market, and install it;



APP: CamSC

6

4. Click ⚙ in APP'S first interface, select Time Zone and choose Time Zone to ensure live streaming video with the set time zone.

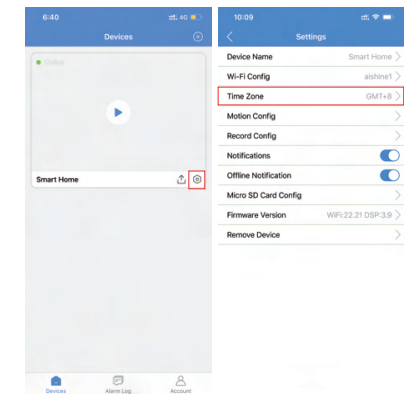

10

### Camera Normal Status:

1. Camera always in standby mode;
2. Once motion detected, it will push a notification to phone, do a snapshot and record a 15 seconds video clip into memory card;
3. Sleep and alert after 1 minute once motion detected again.

**Set name:** Press the  after the camera, select Device Name  
--> Input needed name like Office, Living room etc...



11

### APP Introduction

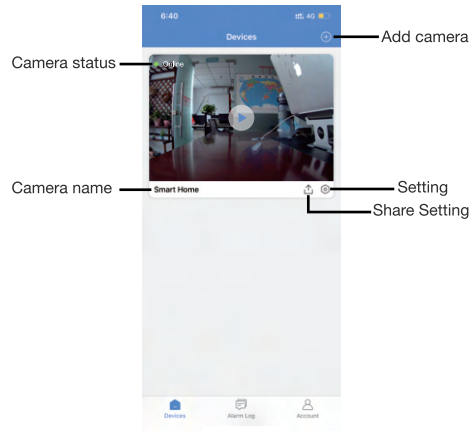

12

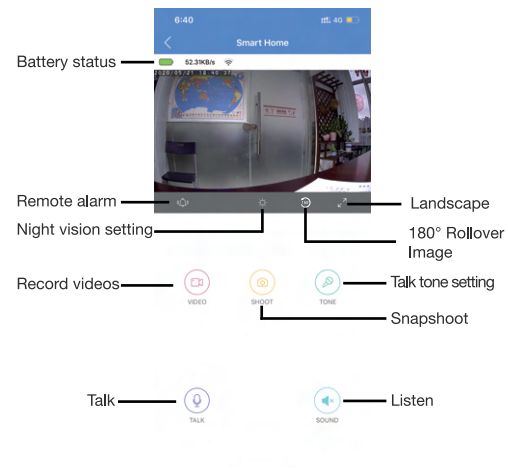

13

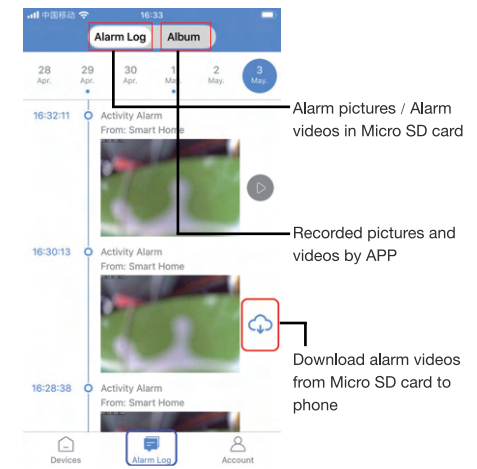

14

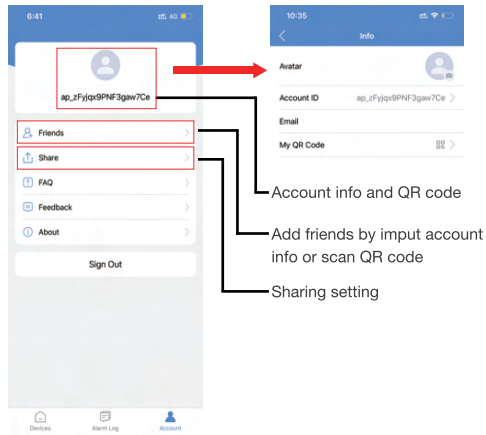

15

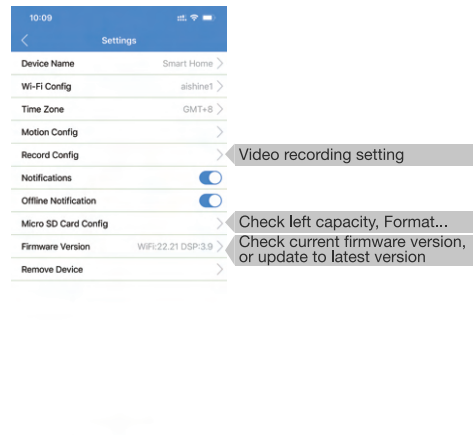

16

### Specification

Resolution	2 Mega CMOS
Video pixel	1920*1080
Compressed format	H.264
View angle	145 Degree
Type of memory card	TF card>=Class 4/10 and HC marked
Maximum capacity of memory card	64GB
Mobile phone operation system	Android/iOS
Compatible router	2.4G and Mobile hotspot
Two way talking	Yes
PIR alarm pictures in server	15days
Battery capacity	4500mAh
Standby power consumption	500µA
Power consumption	350mAh
Power consumption with night vision	610mAh
Recording	1 minute/ around 24MB
Standby time	Around 1 year
Charging time	Around 10 hours
Power adapter (not include but needed)	5V / 2A

17

### FAQ

1. Is device with offline and low power notification?  
Yes.
2. What does the device do when WiFi off?  
Keep searching WiFi signal 3mins, 10mins, 1hour, 2 hours, 5hours,24hours later; If WiFi on, it will be connected to WiFi automatically.
3. If the steps in Page 9 can't move forward (Bluetooth Pairing Mode)?  
Delete the App and Download again to test, and agree all permissions (Allow notification, Bluetooth and location).

18

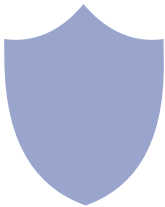

The end!