



SPLIT-TYPE AIR CONDITIONER

	INDOOR UNIT	OUTDOOR UNIT
Basic Model	ASV09PSBANED ASV12PSBBNED ASV18PSBANED	ASV09PSBAXED ASV12PSBBXED ASV18PSBAXED
Model Code	ASV09PSBANXLA ASV12PSBBNXLA ASV18PSBANXLA	ASV09PSBAXXLA ASV12PSBBXXLA ASV18PSBAXXLA

SERVICE *Manual*

AIR CONDITIONER



ASV09 (12) PSBAXED



ASV18PSBAXED

THE FEATURE OF PRODUCT

- **High Energy Efficiency BLDC**
Air Conditioner
- **good'sleep Mode**
good'sleep Mode can help you sleep quickly and soundly and wake up refreshed.
- **Silence Mod**
When you use the "Silence Mode", you can experience extremely quiet operation of your air conditioner.

Refer to the service manual in the GSPN(see the rear cover) for the more information.

Contents

1. Precautions	1-1
1-1 Installing the air conditioner	1-1
1-2 Power supply and circuit breaker	1-1
1-3 During operation	1-1
1-4 Disposing of the unit	1-2
1-5 Others	1-2
2. Product Specifications	2-1
2-1 The Feature of Product	2-1
2-2 Product Specifications	2-2
2-3 The Comparative Specifications of Product	2-3
2-4 Accessory and Option Specifications	2-4
3. Alignment and Adjustments	3-1
3-1 Test Mode	3-1
3-2 Display Error and Check Method	3-2
3-3 Setting Option Setup Method	3-4
4. Disassembly and Reassembly	4-1
4-1 Indoor Unit	4-2
4-2 Outdoor Unit	4-8
5. Exploded Views and Parts List	5-1
5-1 Indoor Unit	5-1
5-2 Outdoor Unit	5-3
5-3 Ass'y Control In	5-5
5-4 Ass'y Control Out	5-7
6. Electrical Parts List	6-1
7. Wiring Diagram	7-1
7-1 Indoor Unit	7-1
7-2 Outdoor Unit	7-2
8. Schematic Diagram	8-1
8-1 Indoor Unit	8-1
8-2 Outdoor Unit	8-2

Contents

9. Refrigerating Cycle Diagram	9-1
10. PCB Diagram	10-1
10-1 Indoor PCB	10-1
10-2 Outdoor PCB	10-2
11. Operating Instructions	11-1
11-1 Name of Each Part	11-1
11-2 Wireless Remote Control-Buttons and Display	11-3
11-3 Main Function	11-4
12. Troubleshooting	12-1
12-1 Items to be checked first	12-1
12-2 Fault Diagnosis by Symptom	12-2
12-3 PCB Inspection Method	12-25
12-4 Main Part Inspection Method	12-27
13. Block Diagram	13-1
13-1 Indoor Unit	13-1
13-2 Outdoor Unit	13-3
14. Reference Sheet	14-1
14-1 Index for Model Name	14-1
14-2 Low Refrigerant Pressure Distribution	14-2
14-3 Pressure & Capacity mark	14-3
14-4 Q & A for Non-trouble	14-4
14-5 Cleaning/Filter Change	14-7
14-6 Installation	14-9
14-7 Installation Diagram of Indoor Unit and Outdoor Unit	14-10
15. WORKING RANGE	15-1
15-1 Power Supply	15-1
15-2 Working Range.....	15-1
15-2-1 MULTIZONE/MONOZONE/SUMMIT	15-1
15-2-2 BIGFLOW.....	15-2

1. Precautions

1-1 Installing the air conditioner

- Users should not install the air conditioner by themselves.
Ask the dealer or authorized company to install the air conditioner except the window-type air conditioner in U.S.A and Canada.
- If you don't install the air conditioner properly, it may cause a fire, a water leakage or an electric shock.
- You must install the air conditioner according to the national wiring regulations and safety regulations.
- Install the indoor unit higher than 2.5m from the floor to avoid the injury caused by the operation of the fan.
(except the window-type air conditioner)
- The manufacturer is not responsible for any accidents or injury caused by an incorrect installation.
- When installing the built-in type air conditioner, keep all electric cables such as the power cable and the connection cord in pipes, ducts, or cable channels to protect them from the danger of impact or any other incidents.

1-2 Power supply and circuit breaker

- If the power cord of the air conditioner is damaged, it must be replaced by the manufacturer or a qualified person in order to avoid a hazard.
- The air conditioner must be plugged into an independent circuit if applicable or connect the power cable to the auxiliary circuit breaker.
An all pole disconnection from the power supply must be incorporated in the fixed wiring with a contact opening of >3mm.
- Do not extend an electric cord to the air conditioner.
- The air conditioner must be plugged in after you complete the installation.

1-3 During operation

- Do not repair the air conditioner at your discretion.
It is recommended to contact a service center directly.
- Never spill any kind of liquid on the air conditioner.
If this happens, turn off the air conditioner and contact an authorized service center.
- Do not insert anything between the airflow blades to prevent damage of the inner fan and consequent injury.
Keep children away from the air conditioner.
- Do not place any obstacles in front of the air conditioner.
- Do not spray any kind of liquid into the indoor unit. If this happens, turn off the air conditioner and contact a service center.
- Make sure that the air conditioner is well ventilated at all times:
Do not place a cloth or other materials over it.
- Remove the batteries if you don't use the remote control for a long time. (If applicable)
- Use the remote control within 7 meters from the indoor unit. (If applicable)

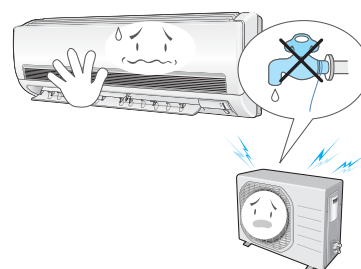

1-4 Disposing of the unit

- Before throwing out the air conditioner, remove the batteries from the remote control.
- When you dispose of the air conditioner, consult your dealer. If pipes are removed incorrectly, refrigerant may blow out and cause air pollution. When it contacts with your skin, it can cause skin injury.
- The package of the air conditioner should be recycled or disposed of properly for environmental reasons.

1-5 Others

- Never store or load the air conditioner upside down or sideways to prevent the damage to the compressor.
- Young children or infirm persons should be always supervised when they use the air conditioner.
- Max current is measured according to IEC standard for safety.
- Current is measured according to ISO standard for energy efficiency.

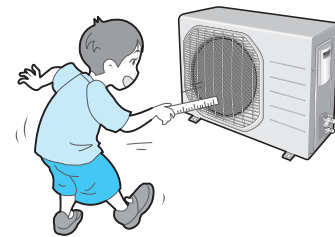

2. Product Specifications

2-1 The Feature of Product

- **good' sleep Mode**

good'sleep mode can help you sleep quickly and soundly and wake up refreshed.

- **Catechin Filter**

- **Silver Nano Evaporator**







- **Deodorizing Filter**

them with clean,refreshing air.

2-2 Product Specifications





ITEM				MODEL		ASV09PSBA/ED		ASV12PSBB/ED		ASV18PSBA/ED			
				Indoor Unit		Outdoor Unit		Indoor Unit		Outdoor Unit		Indoor Unit	
Type				Wall-mounted		Wall-mounted		Wall-mounted		Wall-mounted		Wall-mounted	
Performance	Capacity	Cooling	KW	0.75/2.65/3.2		0.75/3.05/3.65		1.2/5.29/6.2					
		Heating	(Low/Std/Max)	-		-		-					
	Running Frequency	Cooling	Hz	18/50/60		18/57/75		15/63/73					
		Heating	(Low/Std/Max)	-		-		-					
	Noise	声压	dB	41	53	43	53	46	57				
		声功率	(H/L)	-	-	-	-	-	-				
	Energy Efficiency Ratio	Cooling	W/W (Std)	3.61		3.72		3.6/12.28/12.96					
Heating			-		-		-						
Power			ph-V-Hz		1phase, 220V, 60Hz		1phase, 220V, 60Hz		1phase, 220V~, 60Hz				
Pow	Power Consumption	Cooling	KW	0.29/0.74/1.11		0.3/0.82/1.21		0.31/1.47/1.8					
		Heating	(Low/Std/Max)	-		-		-					
	Operating Current	Cooling	A	1.7/3.8/5.0		1.9/4.4/5.8		1.6/7.2/8.3					
		Heating	(Low/Std/Max)	-		-		-					
	Power Factor	Cooling	%	77/92/93		76/94/95		82/93/96					
		Heating	(Low/Std/Max)	-		-		-					
Size	Gross Dimension	W*D*H	mm	875*360*260	852*635*358	875*360*260	852*635*358	1125*375*290	926*640*384				
	Weight(Net)		kg	9.5	29.5	8.2	25.5	11.5	33				
	Refrigerant Pipe	Liquid	mm	6.35 (1/4 inch)		6.35 (1/4 inch)		6.35 (1/4 inch)					
		Gas	mm	9.52 (3/8 inch)		9.52 (3/8 inch)		12.7 (1/2 inch)					
	Drain Hose		L*D	550±20		550±20		550±20					
	Compressor	Type		UG9A090FUBEPSS(39F AL)		UG9A090FUBEPSS(39F AL)		UG4T150FUJQ					
		Motor	Type	HERMETIC		HERMETIC		HERMETIC					
			Rated Output(W)	-		-		-					
	Oil Type			-		-		-					
	Blower	Type		CROSS-FLOW	PROPELLER	CROSS-FLOW	PROPELLER	CROSS-FLOW	PROPELLER				
motor		Type	BLDC	BLDC	BLDC	BLDC	BLDC	BLDC					
Heat Exchanger			2ROW x 10STEP x 605	1row x 24step x L757	2ROW x 10STEP x 605	2ROW x 4STEP x 575	2ROWx10STEPx850	1ROWx50STEPx804					
Refrigerant Control Unit			R410		R410		R410						
Freezer Oil Capacity	cc			-		-		-					
Refrigerant to Change(R410A)	g			730		600		850					
Proterction Device(OLP)			NONE		NONE		NONE						
Operation condition range	Cooling			-10℃~46℃		-10℃~46℃		-10℃~46℃					
	Heating			-15℃~24℃		-15℃~24℃		-15℃~24℃					

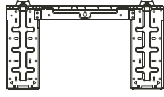

2-3 The Comparative Specifications of Product

MODEL		Develop Model		
		AR12HSFSAWK/ET	AR18HSFSAWK/EU	AR24HSFSAWK/EU
Design	Indoor Unit			
	Outdoor Unit			
Net Weight	Indoor Unit	9.5	8.2	11.5
	Outdoor Unit	29.5	25.5	33
Outer Dimension	Indoor Unit	875*360*260	875*360*260	1125*375*290
	Outdoor Unit	852*635*358	852*635*358	926*640*384
Noise	Indoor Unit	41	43	46
	Outdoor Unit	53	53	57
Air Purifying System	Filter	FULL HDFILTER	FULL HDFILTER	FULL HDFILTER

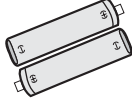
2-4 Accessory and Option Specifications

2-4-1 Accessories

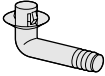
Item	Descriptions	Code-No.	Q'TY	Remark
	Assy Plate Hanger	DB97-02851C(09K/12K) DB90-02738A(18K)	1	Indoor Unit
	Remote Control	DB93-11489C	1	
	Batteries for Remote Control	4301-000121	2	
	Manual	DB98-32440A(09K/18K) DB68-03248A(12K)	1	

Item	Descriptions	Code-No.	Q'TY	Remark
	Drain Plug	DB67-20011A	1	Outdoor Unit
	Rubber Leg	DB73-20134A	4	

3. Alignment and Adjustments

3-1 Test Mode

■ How to Approach Test Mode

You can approach the Test Mode by pressing the on/off switch of indoor unit for 5 seconds.

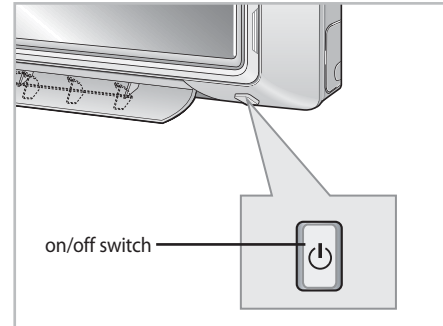

■ Test Mode Operation Option

After installing the air conditioner, check whether each subordinate is normally operated or not by operating the Test Mode.

- **When an error occurs, display the Error Mode.**
- **Operation Mode :** Cool mode. Operate the cool mode by operating the compressor by force without the compressor ON/OFF according to the set temperature/indoor temperature. (Do not follow the antifreeze control)
- **Up-down louver :** Up-down swing mode
- **Indoor Fan :** High



• Because the Test Mode operate the cool mode by force not related to the set temperature / indoor temperature, check whether each subordinate is operated normally or not after completing installation and must turn off the power of the air conditioner.

3-2 Display Error and Check Method

3-2-1 Indoor Display Error and Check Method

■ ASV09PSBANED,ASV12PSBBNED

OPERATION	TIMER	GOOD SLEEP	DESCRIPTION
<input type="radio"/>	<input checked="" type="radio"/>	<input type="radio"/>	Indoor Room Temp Sensor Error
<input checked="" type="radio"/>	<input checked="" type="radio"/>	<input type="radio"/>	Evap In Temp Sensor Error
<input type="radio"/>	<input type="radio"/>	<input checked="" type="radio"/>	Fan Error (Indoor)
<input checked="" type="radio"/>	<input checked="" type="radio"/>	<input checked="" type="radio"/>	EEPROM Error
<input checked="" type="radio"/>	<input checked="" type="radio"/>	<input checked="" type="radio"/>	Option Error

- LED ON
- ◎ LED BLINKING
- LED OFF

3-2 Display Error and Check Method

3-2-1 Indoor Display Error and Check Method

■ ASV18PSBANED

ERROR MODE			DESCRIPTION
AQV**P**/ASV**P**			
Oper.	Timer	Good Sleep or SPI OPTION A	
×	○	○	Communication error (indoor<->outdoor) Pre power relay error
×	○	×	Indoor room temp sensor error
○	○	×	Evap in temp sensor error
×	×	○	Fan error(indoor)
○	×	○	Outdoor error display
○	○	○	EEPROM error
○	○	○	Option error

● LED ON
 ○ LED BLINKING
 × LED OFF

OPTION	DESCRIPTION
OPTION A	SPI
OPTION B	T/B FUSE OPTION

3-2-2 Outdoor LED Display Error and Check Method

■ ASV09PSBAXED, ASV12PSBBNED

YEL	GRN	RED	DESCRIPTION
○	○	○	Power Off
◎	◎	◎	Reset
●	●	●	Reset
○	◎	●	Normal Operation
○	○	●	Abnormal Communication
○	●	●	
○	○	◎	IPM Over Current(O.C)
○	◎	○	Comp Starting Error
○	◎	◎	Heatsink Sensor Error
			Heatsink Over Heat
○	●	◎	DC-Link Voltage Under/Over Error
			Over Voltage Protection Error
◎	○	●	OLP Over Heat
◎	◎	○	OLP Sensor Error
◎	◎	●	Current Sensor Error
			Input Current Sensor Error
◎	●	○	Comp Vlimit Error
			Comp Current Limit Error
◎	●	●	1min. Time Out Comm.
●	○	◎	OTP Error
●	○	●	Comp Wire Missing Error
●	◎	◎	DC-Link Voltage Sensor Error
●	◎	●	I-Trip Error
●	●	◎	AC Line Zero Cross Signal Out

3-2-2 Outdoor LED Display Error and Check Method

■ ASV18PSBAXED

LED PATTERN			DESCRIPTION
YEL	GRN	RED	
○	○	○	Power Off / VDD NG
○	◎	●	Normal Operation
○	○	◎	IPM Over Current(O.C)
○	○	●	Abnormal Serial communication
○	●	●	(Display Board:Indoor<->Outdoor)
○	◎	○	Comp Starting error
○	●	◎	DC-Link voltage under/over error PFC over load / HW DC_link over
◎	○	◎	Outdoor temp sensor error(Dual/Single)
◎	○	●	Discharge over temperature(Dual/Single)
◎	◎	○	Discharge temp sensor error(Dual/Single)
◎	◎	●	Current sensor error/Heatsink sensor error Input current sensor error
◎	●	○	Comp Vlimit error/Heatsink over temp
◎	●	◎	Coil temp sensor error(Dual/Single)
◎	●	●	1min. Time out Comm. (Main <-> Inverter)
●	○	○	Fan error
○	●	○	EEProm data error
●	○	◎	OTP error
●	○	●	Comp rotation error
●	◎	○	Operation condition secession(Dual only)
●	◎	◎	DC-Link voltage sensor error
●	◎	●	I-Trip error / PFC Over current
●	●	○	GAS Leak error(Dual/Single)
●	●	◎	AC Line Zero Cross Signal out
●	●	●	Power ON reset(1sec)
◎	○	○	capacity miss match
○	◎	◎	Test Operation Cooling Mode
◎	◎	◎	Test Operation Heating Mode

● LED ON ○ LED OFF ◎ LED BLINKING

4. Troubleshooting

4-1 Setting Option Setup Method

ex) Option No. :

SEG1	SEG2	SEG3	SEG4	SEG5	SEG6	SEG7	SEG8	SEG9	SEG10	SEG11	SEG12	SEG13	SEG14	SEG15	SEG16	SEG17	SEG18	SEG19	SEG20	SEG21	SEG22	SEG23	SEG24
0	3	0	0	0	0	1	7	0	2	6	0	2	8	3	1	0	0	3	0	0	0	0	0

NOTE :
 SEG1, SEG7, SEG13, SEG19 need not to be pressed in, so in fact the Option No. we should press in is as below.
 30 00 07 02 60 83 10 00 00 00

Step 1 : Enter the Option Setup mode.







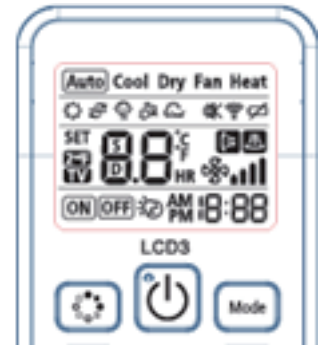



















1st Take out the batteries of remote control.

2nd Press the temperature  button simultaneously and insert the battery again.















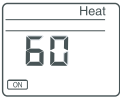













3rd Make sure the remote contr display shown as .



Step 2 : Enter the Option Setup mode and select your option according to the following procedure.

	Feature	Display
	1 The default value is  . Every time you push the  button, the display panel reads  Auto → Cool → Dry → Fan → Heat ,  Auto → Cool → Dry → Fan → Heat repeatedly.	
	2 Push the  button to set the display panel to 3 . Every time you push the  button, the display panel reads 0 → 1 → 2 → 3 → → 9 → A → b → c → d → E → F repeatedly.	
	3 Push the  button to  . Every time you push the  button, the display panel reads 0 → 1 → 2 → 3 → → 9 → A → b → c → d → E → F repeatedly.	
	4 Push the  button to  . Push the  button to set the display panel to 7 . Every time you push the  button, the display panel reads 0 → 1 → 2 → 3 → → 9 → A → b → c → d → E → F repeatedly.	
	5 Push the  button to  . Push the  button to set the display panel to 0 . Every time you push the  button, the display panel reads 0 → 1 → 2 → 3 → → 9 → A → b → c → d → E → F repeatedly.	
	6 Push the  button to set the display panel to 2 . Every time you push the  button, the display panel reads 0 → 1 → 2 → 3 → → 9 → A → b → c → d → E → F repeatedly.	

4-1 Setting Option Setup Method(continue)

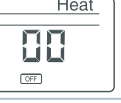
	Feature	Display
	<p>7 Push the  button to  . Push the  button to set the display panel to 6. Every time you push the  button, the display panel reads 0→1→2→3→.....→9→A→b→c→d→E→F repeatedly.</p>	
	<p>8 Push the  button to set the display panel to 8. Every time you push the  button, the display panel reads 0→1→2→3→.....→9→A→b→c→d→E→F repeatedly.</p>	
	<p>9 Push the  button to  . Push the  button to set the display panel to 8. Every time you push the  button, the display panel reads 0→1→2→3→.....→9→A→b→c→d→E→F repeatedly.</p>	
	<p>10 Push the  button to set the display panel to 3. Every time you push the  button, the display panel reads 0→1→2→3→.....→9→A→b→c→d→E→F repeatedly.</p>	
	<p>11 Push the  button to  . Push the  button to set the display panel to 1. Every time you push the  button, the display panel reads 0→1→2→3→.....→9→A→b→c→d→E→F repeatedly.</p>	
	<p>12 Push the  button to  .</p>	
	<p>13 Push the  button to  .</p>	
	<p>14 Push the  button to  .</p>	

Step 3 : Upon completion of the selection, check you made right selections.

Press the Mode  Selection key to set the display part and check the display part.

→ The display part shows like below when each time you press Mode button .

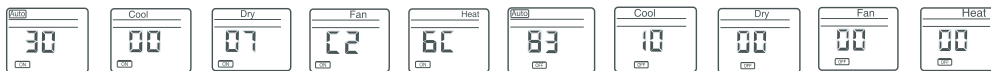

Step 4 : Pressing the ON/OFF button ()

When pressing the operation ON/OFF key with the direction of remote control for unit, the sound "Ding" or "Diriring" is heard and the OPERATION ICON () lamp of the display is flickering at the same time, then the input of option is completed. (If the diriring sound isn't heard, try again pressing the ON/OFF button.)

Step 4 : Pressing the ON/OFF button (⏻)

When pressing the operation ON/OFF key with the direction of remote control for unit, the sound "Ding" is heard and the OPERATION ICON(≡) lamp of the display is flickering at the same time, then the input of option is completed. (If the diring sound isn't heard, try again pressing the ON/OFF button.)

Step 5 : Unit operation test-run

First, Remove the battery from the remote control.

Second, Re-insert the battery into the remote control.

Third, Press ON/OFF key with the direction of remote control for set.

• Error Mode

- 1st If all lamps of indoor unit are flickering, Plug out, plug in power plug again and press ON/OFF key to retry.
- 2nd If the unit is not working properly or all lamps are continuously flickering after setting the option code, see if the correct option code is set up for its model.

■ OPTION ITEMS

Model	Option code
ASV09PSBA/ED	000002-11525F-282000-300000
ASV12PSBB/ED	000001-12124D-282000-300000
ASV18PSBA/ED	012445-10426C-273500-372610 / 034400-113F00-200000-300000







4. Disassembly and Reassembly

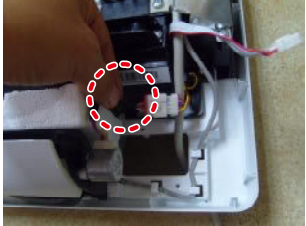

■ Necessary Tools





Item	Remark
SCREW DRIVER	
MONKEY SPANNER	

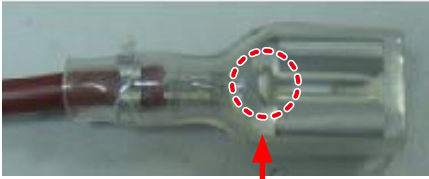

4-1 Indoor Unit

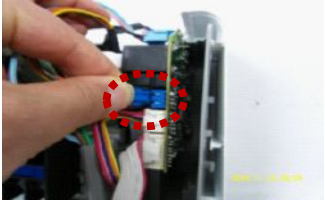

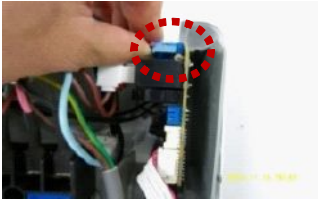

No	Parts	Procedure	Remark
1	PANEL-FRONT	<p>1) Stop the driving of air conditioner and shut o main power supply.</p> <p>2) Open the FRONT-GRILLE and pull out from the PANEL-FRONT.</p> <p>3) Detach COVER-TERMINAL from the PANEL-FRONT.(use + Screw Driver)</p> <p>4) Loosen connector wire(white) and detach the temperature sensor wire.</p> <p>5) To detach the FRONT-PANEL the main frame, unfasten 2 screw at the bottom.(use + Screw Driver)</p> <p>6) Take o the FRONT-PANEL,lifting up the bottom.</p>	    

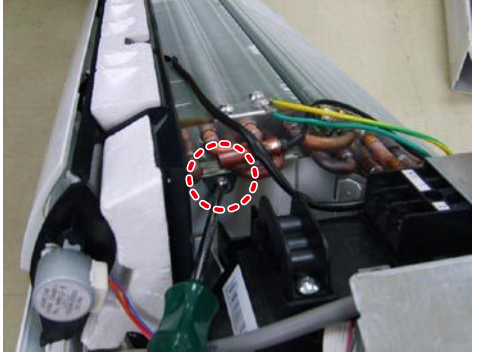
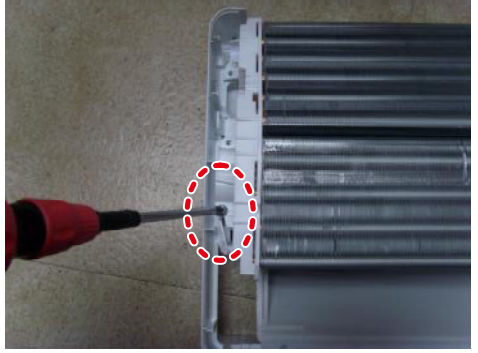
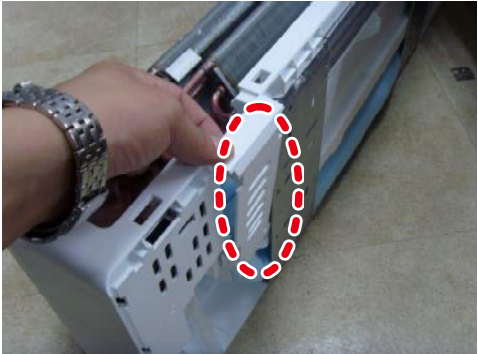
No	Parts	Procedure	Remark
2	TRAY DRAIN	<p>1) Loosen stepping motor wire and detach the hook of main frame.</p> <p>2) To detach TRAY-DRAIN from the main frame, pull the bottom of the TRAY-DRAIN towards you.</p>	 
3	CONTROL IN	<p>1) Unfasten the earth screw.(use + Screw Driver)</p> <p>2) Detach COVER-CONTROL from the CASECONTROL.</p> <p>3) Detach the temperature sensor.</p> <p>4) Loosen MOTOR Wire.</p> <p>5) Take off the CASE-CONTROL from the main frame.</p>	    

No	Parts	Procedure	Remark
4	PBA	1) Unfasten the screw.	
		2) Cut the cable tie.	
		3) Loosen the terminal block wires. ※ Caution: The terminal is locking type. So, when you separate terminals, pull pressing the button.	  <p style="text-align: center; color: red;">Button</p>

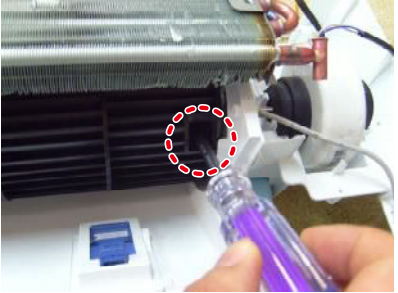

No	Parts	Procedure	Remark
4	PBA	4) Loosen the Motor Feedback connector. ※ Caution: When you separate the connector, pull pressing the locking button.	
		5) Loosen Stepping MOTOR connector. ※ Caution: When you separate the connector, pull pressing the locking button.	
		6) Loosen Main Power connector. ※ Caution: When you separate the connector, pull pressing the locking button.	
		7) Loosen the Thermistor wire connector. ※ Caution: When you separate the connector, pull pressing the locking button.	
		8) Loosen the Relay connector(Red,White).	



No	Parts	Procedure	Remark
5	EVAPORATOR	<p>1) Unfasten the screw at the right side. (use + Screw Driver)</p> <p>2) Unfasten the screw at the left side. (use + Screw Driver)</p> <p>3) Detach the HOLDER PIPE.</p> <p>4) Take off the EVAPORATOR from the main frame.</p>	   

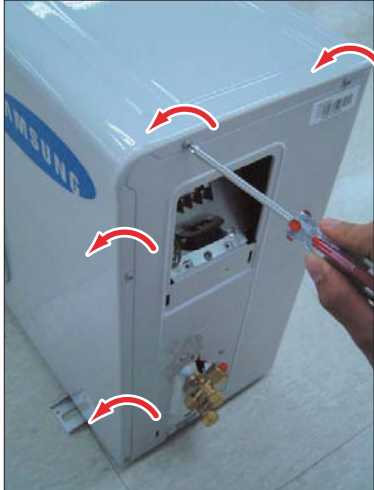
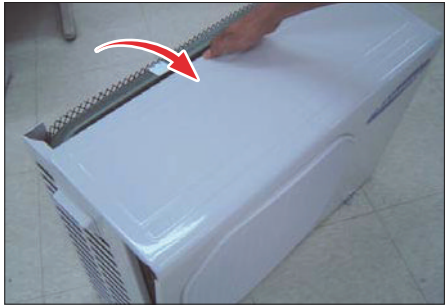
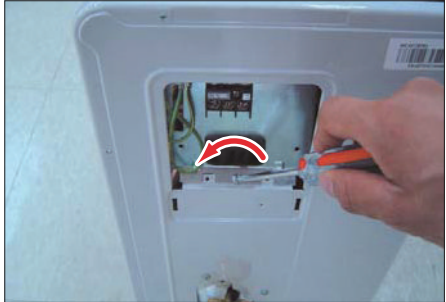

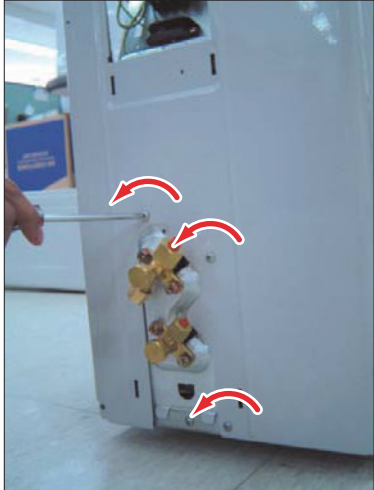
No	Parts	Procedure	Remark
6	FAN MOTOR & CROSS FAN	<p>1) Unfasten the screw in the HOLDER-EVAP on the left side of evaporator.(use + Screw Driver)</p> <p>2) unfasten the 3 points screws in the CASE-CONTROL, and then detach the CASE. (use + Screw Driver)</p> <p>3) unfasten the screw a little.(use + Screw Driver)</p> <p>4) Lift up the evaporator slightly and pull the CROSS-FAN to the left side.</p>	   

4-2 Outdoor Unit (ASV09PSBAXED, ASV12PSBBXED)

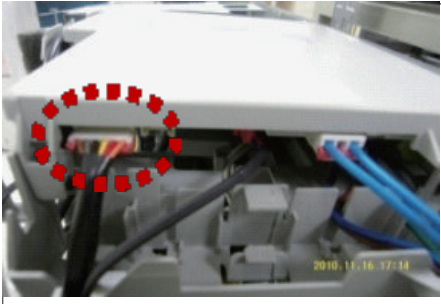
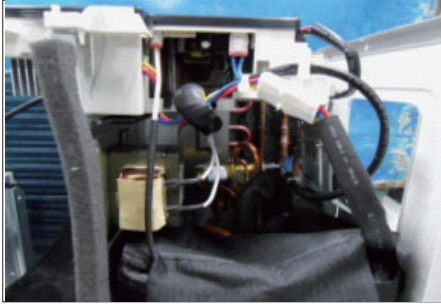
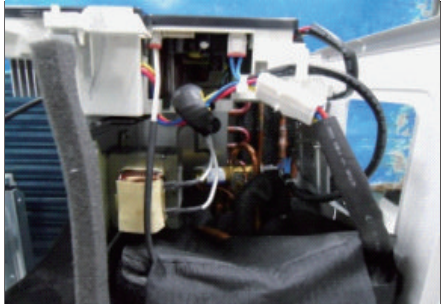

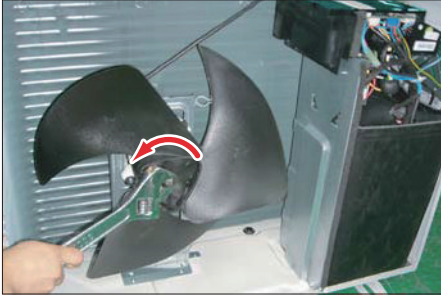
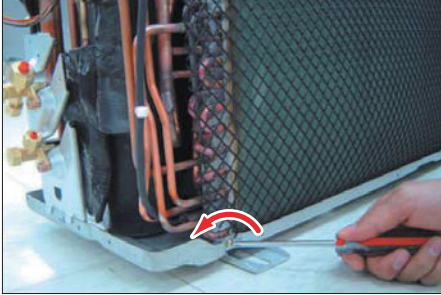
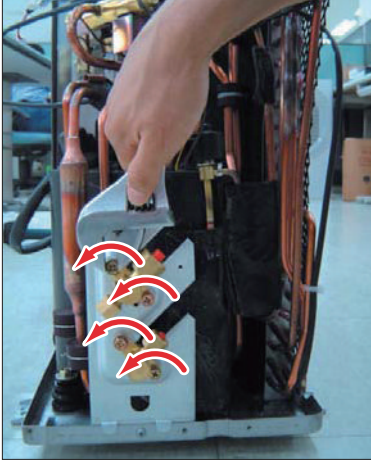

No	Parts	Procedure	Remark
1	Common Work	<p>1) Loosen 1 fixing screw(CCW) of the Cover-Side. (Use +Screw Driver.)</p> <p>2) Loosen each 4 screws(CCW) on both right and left Cabinet Side edges and a fixing screw on the Cabinet Front lower to detach the Cabinet Front. (Use +Screw Driver.)</p> <p>3) Detach the Cabinet Front like the picture on the right side.</p> <p>4) Loosen 1 screw(CCW) fixed to assemble Plate Control Out with Cabinet-Side RH. (Use +Screw Driver.)</p>	   



No	Parts	Procedure	Remark
		<p>5) Loosen 2 fixing screws(CCW) on the rear side of Cabinet-Side RH. (Use +Screw Driver.)</p>	
		<p>6) Loosen 3 screws(CCW) fixed to assemble Bracket Valve with Cabinet-Side RH. (Use +Screw Driver.)</p>	
		<p>7) Loosen 2 fixing screws(CCW) of Cabinet Side LF. (Use +Screw Driver.)</p>	





No	Parts	Procedure	Remark
2	Ass'y Control Out	<p>1) Detach the Motor Wire from the PCB of Ass'y Control Out.</p> <p>2) Detach several connectors from the PCB of Ass'y Control Out.</p> <p>3) Detach 2 Connect Wires from Reactor.</p> <p>4) Loosen 1 screw(CCW) fixed to assemble Ass'y Control Out with Partition. (Use +Screw Driver.)</p>	   

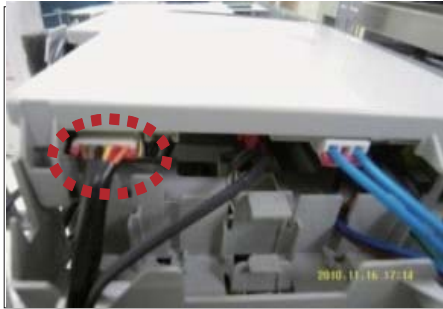
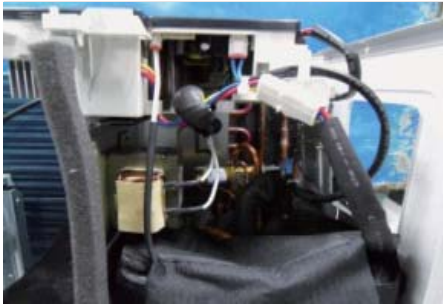
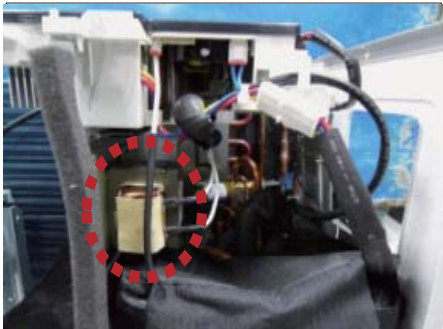

No	Parts	Procedure	Remark
3	Fan & Motor	<ol style="list-style-type: none"> 1) Release the refrigerant at first. 2) Loosen fixing screw(CW). (Use Monkey Spanner.) 3) Disassemble the pipes in both inlet and outlet with welding torch. 4) Detach the Heat Exchanger. 	
4	Heat Exchanger	<ol style="list-style-type: none"> 1) Loosen 2 fixing screws(CCW) on both sides. (Use +Screw Driver.) 2) Disassemble the pipes in both inlet and outlet with welding torch. 3) Detach the Heat Exchanger. <p style="color: red;">⚠ Before you disassemble the pipes and Condenser, be sure that there should be no refrigerant remained in the unit.</p>	
5	Ass'y Valve 4-Way & Ass'y Valve EEV	<ol style="list-style-type: none"> 1) Loosen 4 bolts(CCW) fixed to assemble Valve Service with Bracket Valve like the picture on the right side. (Use Monkey Spanner.) 2) Disassemble the pipes assembled the suction and discharge sides of the Compressor with welding torch. 	
6	Compressor	<ol style="list-style-type: none"> 1) Loosen the Nut(CCW) of Terminal Cover. (Use Monkey Spanner.) 2) Detach the Terminal Cover and detach the Connect Comp Wire from Compressor. 3) Disassemble the Felt Comp Sound. 4) Loosen the 3 bolts(CCW) at the bottom of Compressor like the picture on the right side. (Use Monkey Spanner.) 	

4-2 Outdoor Unit(ASV18PSBAXED)



No	Parts	Procedure	Remark
1	Common Work	<p>1) Loosen 1 fixing screw(CCW) of the Cover-Side. (Use +Screw Driver.)</p> <p>2) Loosen each 5 screws(CCW) on both right and left Cabinet Side edges and a fixing screw on the Cabinet Front lower to detach the Cabinet Front. (Use +Screw Driver.)</p> <p>3) Detach the Cabinet Upper like the picture.</p> <p>4) Loosen 2 screw(CCW) fixed to assemble Plate Control Out with Cabinet-Side RH. (Use +Screw Driver.)</p>	   

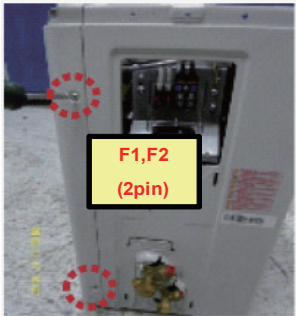
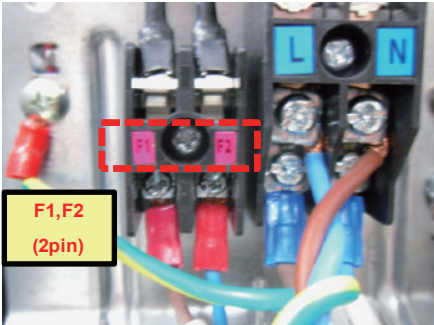

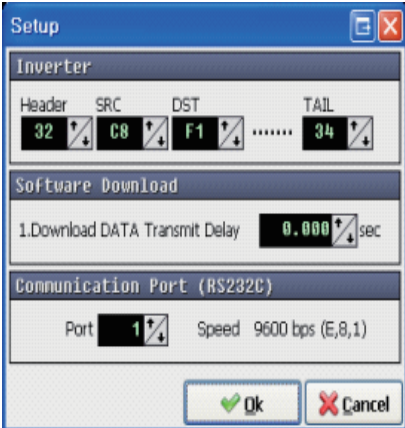
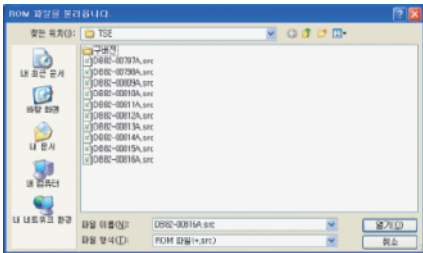

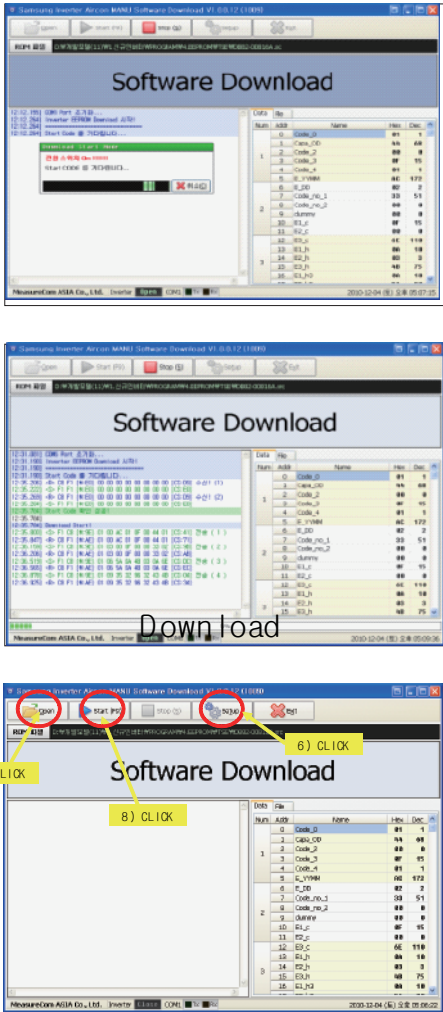
No	Parts	Procedure	Remark
2	Ass'y Control Out	<p>1) Detach the Motor Wire from the PCB of Ass'y Control Out.</p> <p>2) Detach several connectors from the PCB of Ass'y Control Out.</p> <p>3) Detach 2 Connect Wires from Reactor.</p> <p>4) Loosen 1 screw(CCW) fixed to assemble Ass'y Control Out with Partition. (Use +Screw Driver.)</p>	   

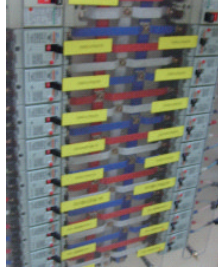
No	Parts	Procedure	Remark
3	Fan & Motor	<ol style="list-style-type: none"> 1) Release Nut at Fan Boss 2) Release 3 screws st Motor Bracket. 3) Detach Motor Wire from the Assy Control Out. 	
4	Heat Exchanger	<ol style="list-style-type: none"> 1) Loosen 1 fixing screws(CCW) on both sides. (Use +Screw Driver.) 2) Disassemble the pipes in both inlet and outlet with welding torch. 3) Detach the Heat Exchanger. <p>⚠ Before you disassemble the pipes and Condenser, be sure that there should be no refrigerant remained in the unit.</p>	
5	Ass'y Valve 4-Way & Ass'y Valve EEV	<ol style="list-style-type: none"> 1) Loosen 4 bolts(CCW) fixed to assemble Valve Service with Bracket Valve like the picture on the right side. (Use Monkey Spanner.) 2) Disassemble the pipes assembled the suction and discharge sides of the Compressor with welding torch. 	
6	Compressor	<ol style="list-style-type: none"> 1) Loosen the Nut(CCW) of Terminal Cover. (Use Monkey Spanner.) 2) Detach the Terminal Cover and detach the Connect Comp Wire from Compressor. 3) Disassemble the Felt Comp Sound. 4) Loosen the 3 bolts(CCW) at the bottom of Compressor like the picture on the right side. (Use Monkey Spanner.) 	

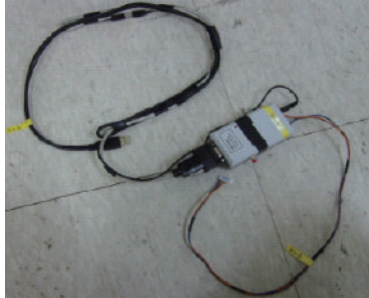
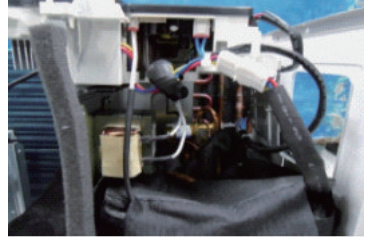
No	Parts	Procedure	Remark
1		<p>5) Execute the Universal EEPwriter program</p> <p>6) Select COM Port and connect</p> <p>7) Open the file</p>	    

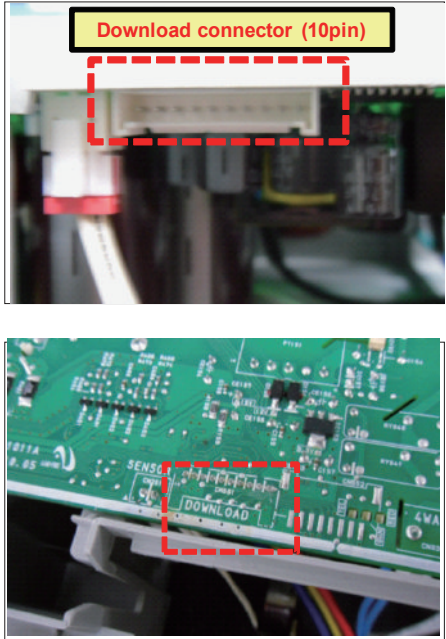
No	Parts	Procedure	Remark
1		8) Click the Start button and reset the power	 <p>The 'Remark' column contains three screenshots of the 'Software Download' window. The first screenshot shows the 'Start' button. The second screenshot shows the 'Download' progress bar. The third screenshot shows the 'Start' button circled in red with a yellow callout '7) CLICK'. The 'Start' button is also circled in red with a yellow callout '8) CLICK'. The 'Stop' button is circled in red with a yellow callout '6) CLICK'.</p>

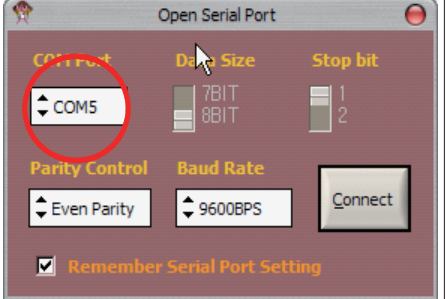
No	Parts	Procedure	Remark
2	Maldives Normal EER (only)	1) Power off 2) Take off the Cabinet : Check the LED off 3) Connect PC-Download Jig-PBA	     <p data-bbox="978 1715 1348 1765">Download connector (10pin)</p> 

No	Parts	Procedure	Remark
		3) Connect PC-Download Jig-PBA	
		5) Execute the Universal EEPwriter program	
		6) Select COM Port and connect	
		7) Open the file 8) Start Download	

5. Exploded Views and Parts List

5-1 Indoor Unit (AQV12PSBANXAX/ASV12(09)PSBAN*)

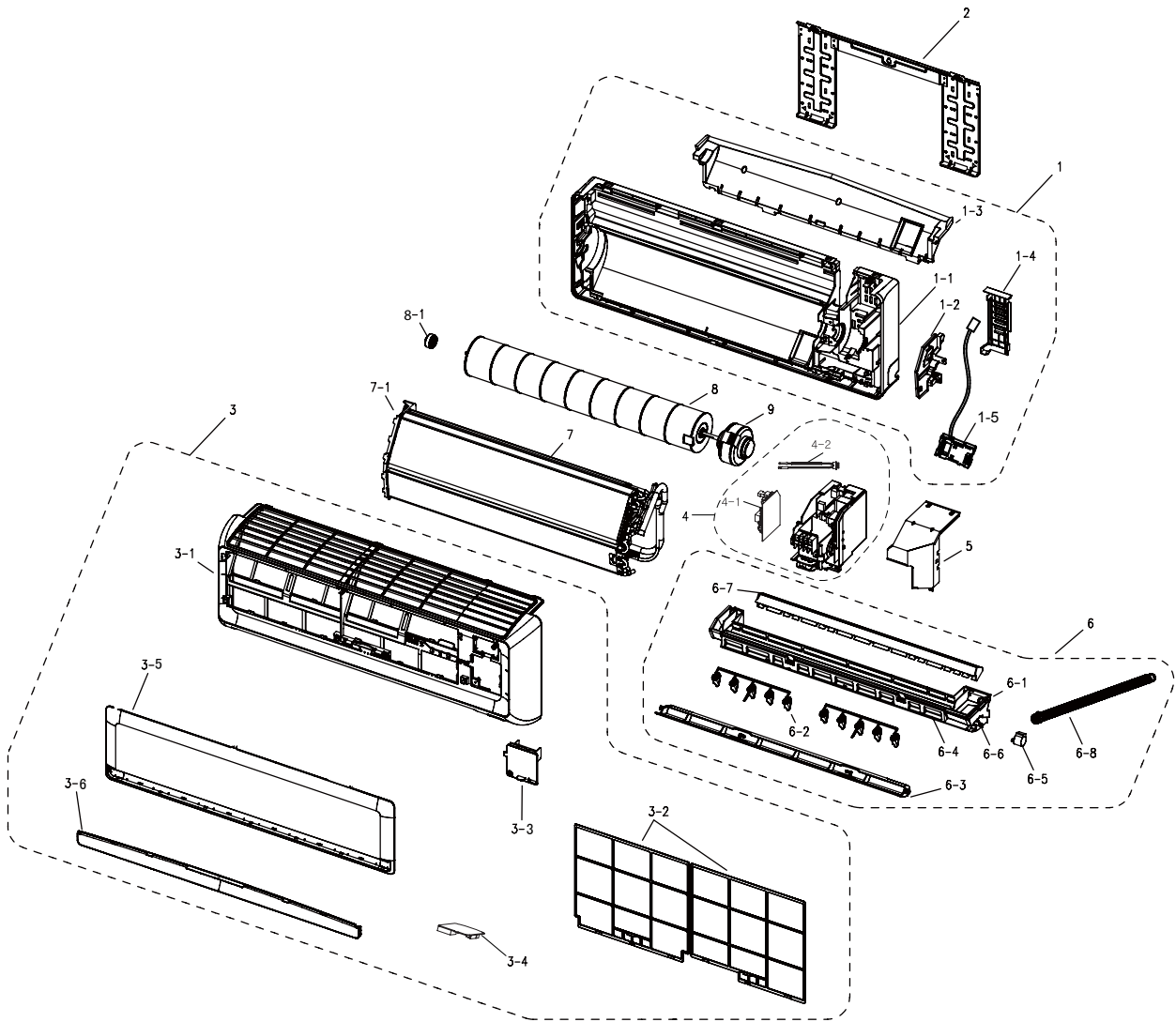

■ Parts List

No.	Code No.	Description	Specification	Qty			SA/SNA
				ASV12(09)PSBAN*	AQV12PSANXAX	ASV12(09)PSBANXAZ	
1	DB94-02534A	ASSY BACK BODY	ASSY	1	1	—	SA
	DB94-02534B	ASSY BACK BODY	ASSY	—	—	1	SA
1-1	DB61-03656A	BODY BACK	HIPS	1	1	1	SA
1-2	DB61-03651B	SUPPORT-EVAP RH	HIPS	1	1	1	SA
1-3	DB62-05888A	SEAL-INSUL BODY REAR	EPS (30)	1	1	1	SA
1-4	DB61-03666A	HOLDER-PIPE	HIPS	1	1	1	SA
1-5	DB93-08656A	ASSY-SPI SLIM COMPACT	ASSY	1	1	1	SA
2	DB97-02851C	ASSY-PLATE HANGER	SGCC-M, TO. 7	1	1	1	SA
3	DB92-02280C	ASSY PANEL FRONT	ASSY	1	1	—	SA
	DB92-02280P	ASSY PANEL FRONT	ASSY	—	—	1	SA
3-1	DB64-02561A	PANEL FRONT	HIPS	1	1	1	SA
3-2	DB63-02760D	FILTER-PRE	PP	2	2	2	SA
3-3	DB97-11240C	ASSY COVER TERMINAL	ASSY	1	1	1	SA
3-4	DB90-06134A	ASSY COVER DISPLAY	ASSY	1	1	1	SA
3-5	DB64-02553C	GRILLE-AIR INLET	HIPS	1	1	—	SA
	DB64-02553E	GRILLE-AIR INLET	HIPS	—	—	1	SA
3-6	DB64-02550B	DECO-GRILLE	HIPS	1	1	1	SA
4	DB93-10953A	ASSY CONTROL IN	ASSY	1	1	—	SA
	DB93-10953B	ASSY CONTROL IN	ASSY	—	—	1	SA
4-1	DB93-10859G	ASSY PCB MAIN IN	PCB	1	1	1	SA
4-2	DB95-04570B	ASSY THERMISTOR IN	SENSOR	1	1	1	SA
5	DB90-04385A	ASSY COVER CONTROL IN	TO. 5	1	1	1	SA
6	DB94-02960A	ASSY TRAY DRAIN	ASSY	1	1	—	SA
	DB94-02960B	ASSY TRAY DRAIN	ASSY	—	—	1	SA
6-1	DB63-02118A	TRAY DRAIN	ABS	1	1	1	SNA
6-2	DB61-03672A	BLADE-V	PP	2	2	2	SNA
6-3	DB66-01559A	BLADE-H	ABS	1	1	1	SA
6-4	DB62-05892A	INSULATION-TRAY FR	FR EPS (30)	1	1	1	SA
6-5	DB31-00371A	MOTOR STEP	DC12V, 600gf. cm	1	1	1	SA
6-6	DB69-00839A	CUSHION-TRAY RH	EPS (30)	1	1	1	SA
6-7	DB63-02121A	TRAY-STABILIZER	HIPS	1	1	1	SA
6-8	DB94-00458D	ASSY DRAIN-HOSE	ASSY	1	1	—	SA
	DB94-00458E	ASSY DRAIN-HOSE	ASSY	—	—	1	SA
7	DB96-11359B	ASSY EVAP TOTAL	ASSY	1	1	—	SA
	DB96-12152G	ASSY EVAP TOTAL	ASSY	—	—	1	SA
7-1	DB61-03650A	HOLDER-EVAP	HIPS	1	1	1	SA
8	DB94-01874A	ASSY-CROSS FAN ASSY	AS +GF 30%	1	1	1	SA
8-1	DB94-00455B	ASSY RUBBER BEARING	ASSY	1	1	1	SA
9	DB31-00531D	MOTOR FAN	ASSY	1	1	—	SA
	DB31-00531C	MOTOR FAN	ASSY	—	—	1	SA

5-2 Outdoor Unit

AQV12PSBAXX/ASV12 (09) PSBA*

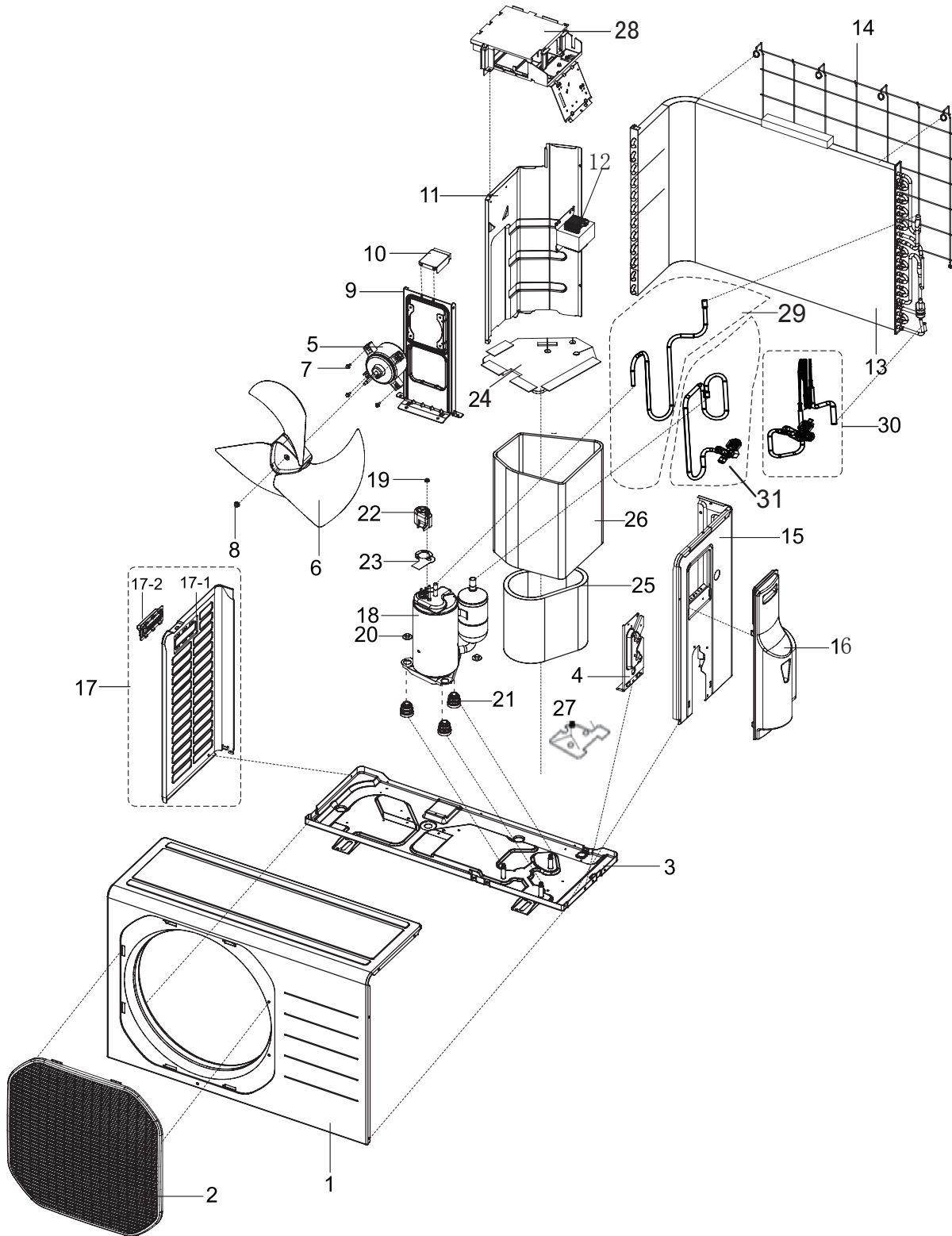

■ Parts List

No.	Code No.	Description	Specification	Qty		SA/SNA
				AQ(S) V12(09) PSBA*		
1	DB90-05752A	ASSY CABI FRONT	ASSY		1	SA
	DB90-06424A	ASSY CABI FRONT	ASSY		-	SA
2	DB63-02588A	GUARD FAN	PP		1	SA
	DB63-02004A	GUARD FAN	PP		-	SA
3	DB90-06226A	ASSY BASE OUT	ASSY		1	SA
4	DB90-05738A	BRACKET-VALVE	SGCC-M(PAINTED)		1	SA
5	DB31-00564A	MOTOR FAN	ASSY		1	SA
6	DB67-01042A	FAN-PROPELLER	PP-(GF+PD)40, Φ410		1	SA
7	6009-001369	SCREW-HEX	M4, L12		3	SA
8	DB60-30004A	SCREW-MACHINE	M6, ZPC(WHT)		1	SA
9	DB90-06219B	BRACKET MOTOR	SGCC-M		1	SA
10	DB90-05736A	ASSY CABINET-UPPER	ASSY		1	SA
11	DB94-02998A	ASSY-PARTITION	ASSY		1	SA
12	DB27-00042B	COIL CHOKE-REACTOR	5mH, 15A		1	SA
13	DB96-15014A	ASSY COND	ASSY		1	SA
14	DB64-02444A	SCREEN-COND BAR	ASSY		1	SA
15	DB90-05751A	ASSY CABINET-SIDE RH	ASSY		1	SA
16	DB90-05740A	ASSY COVER VALVE	ASSY		1	SA
17	DB90-05749A	ASSY CABINET-SIDE LF	ASSY		1	SA
18	UG9A090FUBJPSS	COMPRESSOR	ROTARY		1	SA
19	6021-001142	NUT-HEXAGON FLANGE	M5, ZPC(YEL)		1	SA
20	DB60-30028A	SCREW-HEX	M8, ZPC(WHT)		3	SA
21	DB99-01063A	GROMMET ISOLATOR	ASSY		3	SA
22	DB63-02310A	COVER TERMINAL	NORYL		1	SA
23	DB63-00817B	GASKET	EPDM RUBBER		1	SA
24	DB63-02863A	FELT-COMP UPPER OUT	FELT+PVC		1	SA
25	DB63-02861A	FELT-COMP SIDE	FELT		1	SA
26	DB63-02860A	FELT-COMP SIDE OUT	FELT+PVC		1	SA
27	DB63-02864A	FELT-COMP BASE	FELT		1	SA
28	DB93-10960A	ASSY CONTROL OUT	ASSY		1	SNA
29	DB96-15985A	ASSY TUBE DISCHARGE	ASSY		1	SA
30	DB96-14952B	ASSY-VALVE CHECK	ASSY		1	SA
31	DB96-15980A	ASSY-TUBE SUCTION	ASSY		1	SA

5-3 ASSY-CONTROL IN

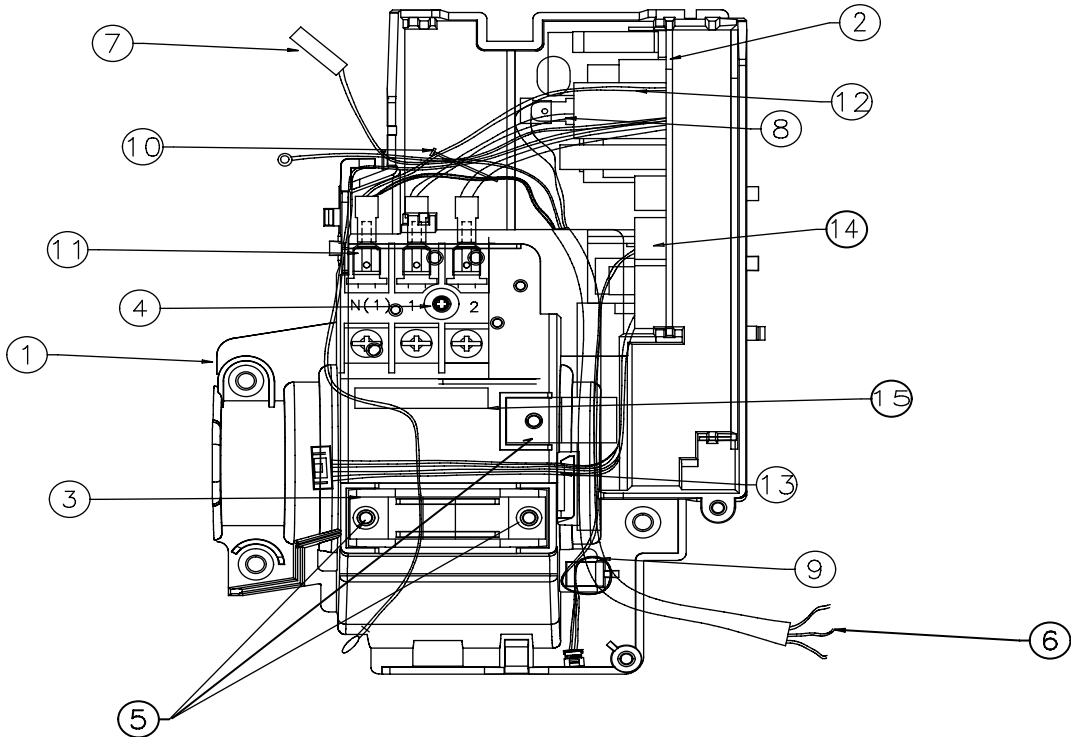

ASSY CONTROL IN CODE		DB93-10953B		
APPLY MODEL		ASV09PSBANED		
NO	NAME	SPEC	CODE-NO	QTY
1	CASE CONTROL IN	MALDIVE	DB61-04578A	1
2	ASS'Y PCB MAIN	MALDIVE LW COST	DB93-10859G	1
3	HOLDER WIRE CLAMP	ABS,BLK,V21-PJ	DB61-01097A	1
4	SCREW	PH M3*L25	DB91-00309A	1
5	SCREW	TH M4*L10	DB97-02418A	3
6	ASS'Y POWER CORD	ASS'Y POWER CORD	DB91-01260A	1
7	ASS'Y THERMISTOR	3%,BLK,SMH200,WHT	DB95-04570B	1
8	ASSY C/W T/B(1) TO RY71(3)	BRN	DB93-08572A	1
9	ASSY C/W LOUVER	5 PIN	DB93-04688B	1
10	CABLE TIE	NYLON66	DB65-10088D	1
11	TERMINAL BLOCK	[N(1),1,2]	DB65-00181B	1
12	POWER IN WIRE	2 PIN	DB93-10916F	1
13	MAIN PBA TO DISPLAY	9 PIN	DB93-10918C	1
14	MPI WIRE	100MM	DB93-04695B	1
15	LABEL	POWER AND COMM LABEL	DB98-32314A	1

5-1 ASSY-CONTROL IN IN

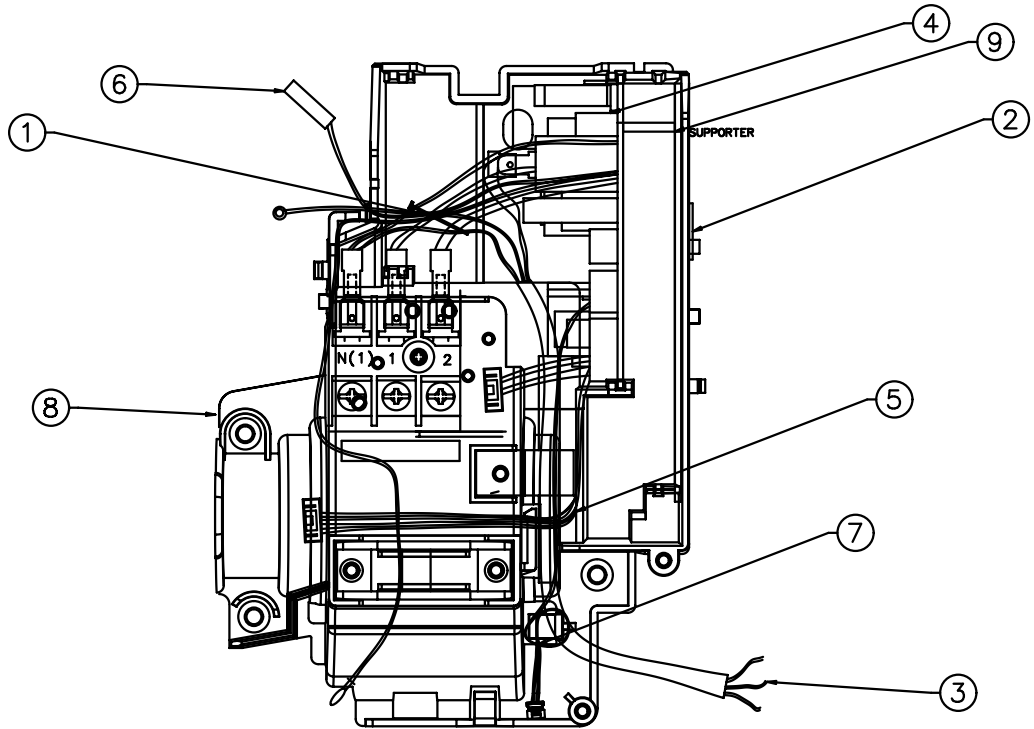

ASSY CONTROL IN CODE		DB93-12913D		
LEVEL	适用型号		ASV12PSBBNED	
	NO	NAME	SPEC	CODE-NO QTY
	1	CABLE-TIE	NYLON	DB65-10088D 1
	2	LABEL BAR CORD	E-PASS	DB68-02809A 1
	3	ASSY POWER CORD	250V, 10A, 2000MM	DB39-01071A 1
	4	ASSY PCB MAIN-IN	MALDIVE LW COST	DB93-12825P 1
	5	ASSY CONNECTOR WIRE	MAIN PBA TO DISPLAY	DB93-10918C 1
	6	ASSY THERMISTOR IN	3*, BLK, SMH200, WHT	DB95-04570B 1
	7	ASSY CONNECTOR WIRE	MPI WIRE, 100MM	DB93-04695B 1
	8	AYYS CASE CONTROL IN	MALDIVE	DB90-06931A 1
	8	SUPPORTER	SUPPORTER	6103-001402 1

5-3 ASSY-CONTROL IN

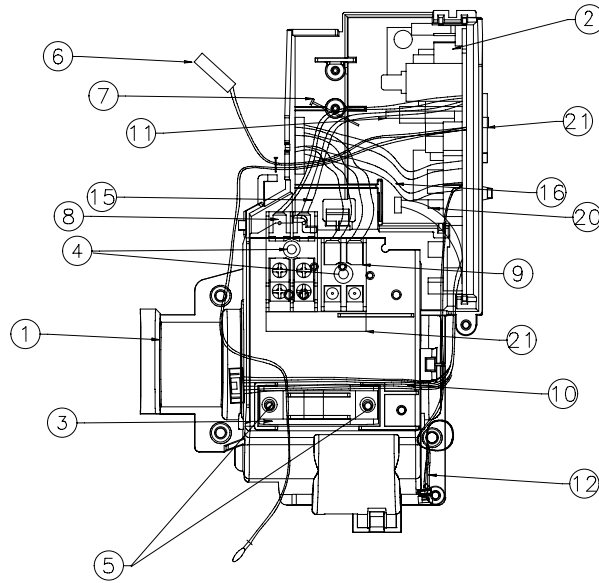

 [PART LIST]

ASSY CONTROL IN CODE			DB93-10958A	DB93-10958B	DB93-10958C	DB93-10958D	DB93-10958E			
Model			MALDIVE3 18K H/P	JUNGFRAU 9~18K H/P	MALDIVE3 24K H/P	MALDIVE3 18K H/P MPI ASV18PSBANED	MALDIVE3 24K H/P MPI			
NO	NAME	SPEC	CODE-NO	QTY	CODE-NO	QTY	CODE-NO	QTY	CODE-NO	QTY
1	CASE CONTROL IN	MALDIVE	DB61-04576A	1	DB61-04726A	1	DB61-04576A	1	DB61-04576A	1
2	ASS'Y PCB MAIN	MALDIVE3	DB93-10956A	1	DB93-10956B	1	DB93-10956A	1	DB93-10956A	1
3	HOLDER WIRE CLAMP	ABS,BLK,V21-PJ	DB61-01097A	1	DB61-01097A	1	DB61-01097A	1	DB61-01097A	1
4	SCREW	PH M3*L25	DB91-00309A	7	6001-000929	7	DB91-00309A	7	DB91-00309A	1
5	SCREW	TH M4*L10	DB97-02418A	2	DB97-02418A	3	DB97-02418A	2	DB97-02418A	2
6	ASS'Y THERMISTOR	3*,BLK,SM200,WHI	DB95-04570B	1	DB95-04570E	1	DB95-04570B	1	DB95-04570B	1
7	CABLE TIE	NYLON66	DB65-10088D	1	DB65-10088D	2	DB65-10088D	1	DB65-10088D	1
8	TERMINAL BLOCK	[1(L),2(N),F1,F2]	DB65-00176C	1	DB65-00176C	1	DB65-00176C	1	DB65-00176C	1
9	TERMINAL BLOCK	(F1,F2)	DB65-00297A	1	DB65-00297A	1	DB65-00297A	1	DB65-00297A	1
10	MAIN PBA TO DISPLAY	10 PIN TO 9 PIN	DB93-10918H	1	DB93-10918L	1	DB93-10918H	1	DB93-10918H	1
11	MAIN PBA TO TERMINAL	2 PIN	DB93-10917A	0	DB93-10917A	0	DB93-10917A	0	DB93-10917A	0
12	ASSY C/W LOUVER	5 PIN,250mm,WHITE	DB93-04688B	1	DB93-10918D	1	DB93-04688B	1	DB93-04688B	1
13	ASSY C/W LOUVER	5 PIN,BLK	DB93-10918E	0	DB93-10918E	1	DB93-10918E	0	DB93-10918E	0
14	ASSY C/W LOUVER	5 PIN,RED	DB93-10918F	0	DB93-10918K	1	DB93-10918F	0	DB93-10918F	0
15	POWER IN WIRE	2 PIN	DB93-10942A	1	DB93-10942A	1	DB93-10942A	1	DB93-10942A	1
16	COMM WIRE	2 PIN	DB95-04339D	1	DB95-04339D	1	DB95-04339C	1	DB95-04339D	1
17	MPI WIRE	4 PIN,100mm	DB93-04695B	0	DB93-04695B	1	DB93-04695B	0	DB93-04695B	1
18	PLATE CONTROL IN	JUNGFRAU	DB61-04724A	0	DB61-04724A	1	DB61-04724A	0	DB61-04724A	0
19	ASS'Y HUMIDITY	3PIN	DB95-01703A	0	DB95-01703A	1	DB95-01703A	0	DB95-01703A	0
20	FJW WIRE	10PIN	DB93-10943H	1	DB93-10943H	1	DB93-10943H	1	DB93-10943H	1
21	LABEL	LABEL	DB68-02809A	1	DB68-02809A	1	DB68-02809A	1	DB68-02809A	1
22	COMMUNICATION LABEL	LABEL	DB98-33292A	1	DB98-33292A	1	DB98-33292A	1	DB98-33292A	1
23	POWER LABEL	LABEL	DB98-33293A	1	DB98-33293A	1	DB98-33293A	1	DB98-33293A	1

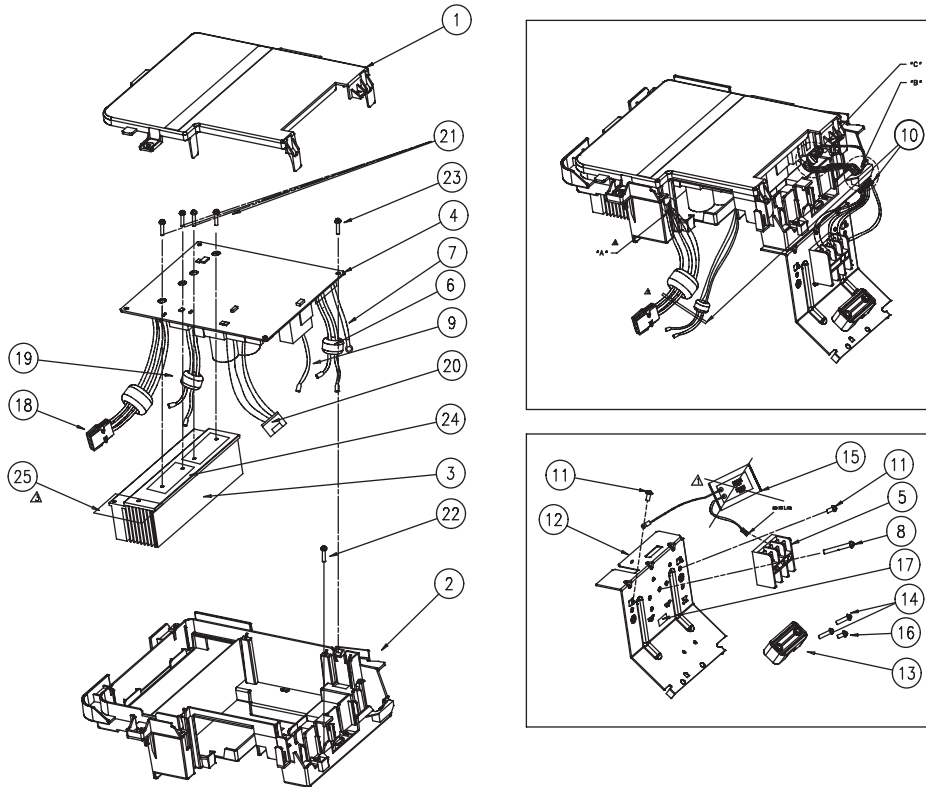

ASSY CONTROL OUT CODE				DB93-10959A
APPLY MODEL				ASV09PSBAXED ASV12PSBBXED
NO	CODE-NO	NAME	SPEC	QTY
1	DB61-04676A	CASE CONTROL-COVER	O1	1
2	DB61-04658A	CASE CONTROL-BASE	S1/O1	1
3	DB62-09724A	HEAT SINK	O1	1
4	DB93-10938A	ASSY PCB MAIN	O1	1
5	DB65-00181B	TERMINAL BLOCK	TERMINAL BLOCK-ASSY	1
6	DB93-09495F	WIRE-POWER	AWG16, BRN, SKYBLU	1
7	DB93-09494C	WIRE-EARTH	AWG20, GRNYEL	1
8	6002-000555	SCREW	M4	1
9	DB93-10820A	WIRE-POWER	AWG20, BLK	1
10	DB65-10088D	CABLE-TIE	NYLON66	2
11	6009-001001	SCREW	TH+	2
12	DB61-04678A	PLATE-CONTROL OUT	O1	1
13	DB61-00250A	HOLDER-WIRE CLAMP	HOLDER-WIRE CLAMP	1
14	6002-000214	SCREW	TH, +, -, 1, M4.0, L16, ZPC(BLK)	2
15	DB95-04748A	ASSY NOISE ABSORBER	*	1
16	6001-001054	SCREW	M4, L25	1
17	DB98-32314A	LABEL	POWER/COMM	1
18	DB93-09497A	WIRE-COMP	AWG16, RED, BLU, YEL	1
19	DB93-09493A	WIRE-REACTOR	AWG16, WHT	1
20	DB93-11026A	WIRE-DOWNLOAD	4PIN	1
21	DB91-00933A	ASSY-SCREW MACHINE	M3, L12	4
22	6002-000527	SCREW	M4, L10	1
23	6002-000630	SCREW	PH +	1
24	0205-001027	THERAL GREASE		2g
25	DB62-04956E	INSULATION-COND IN		1

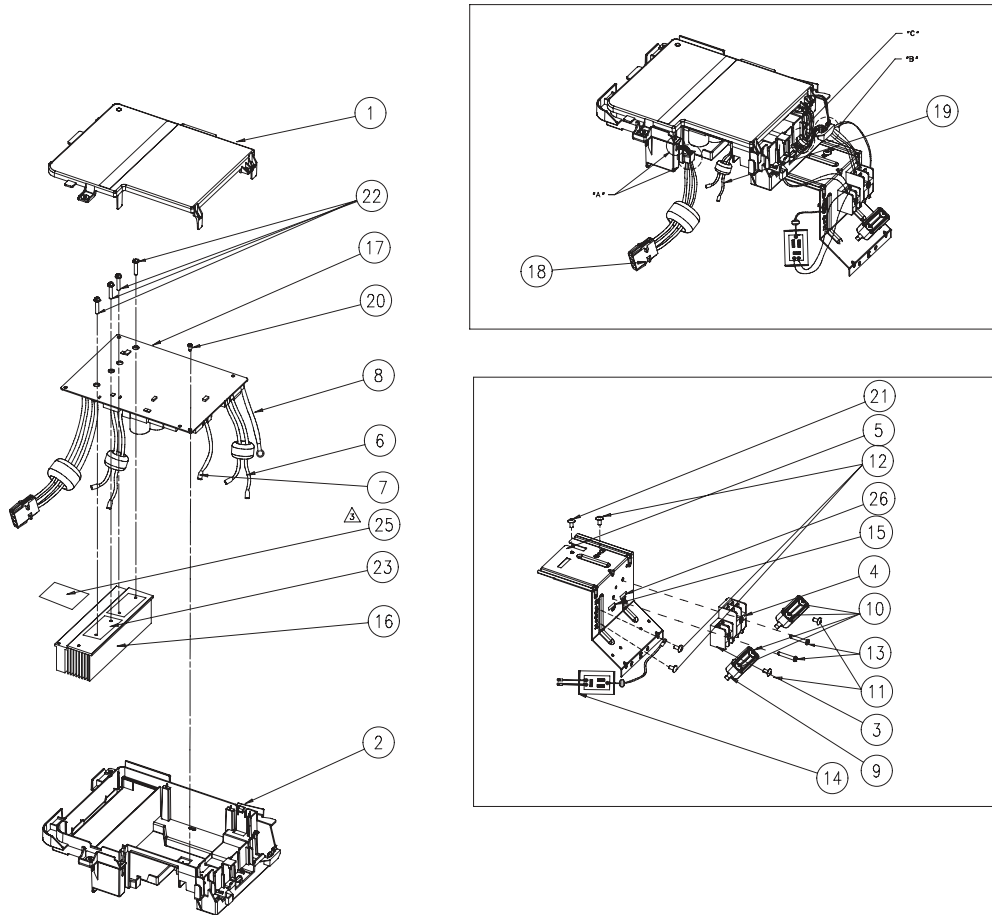

ASSY CONTROL OUT CODE				DB93-10960A	DB93-10960B	DB93-10960C
Model				BLDC FAN AQV09/12PSBX AQV09/12YMAX AQV09/12KBAX	BLDC FAN AQV18PSBX AQV18YMAX AQV18KBAX ASV18PSBAXED	BLDC FAN 50KW 150 COMP DOM
NO	CODE-NO	NAME	SPEC	QTY	QTY	QTY
1	DB61-04659A	CASE CONTROL-COVER	SI	1	1	1
2	DB61-04658A	CASE CONTROL-BASE	SI /O1	1	1	1
3	DB65-00061H	TERMINAL BLOCK	TERMINAL BLOCK-ASSY	1	1	1
4	DB65-00298B	TERMINAL BLOCK	TERMINAL BLOCK-ASSY	1	1	1
5	DB61-04324A	PLATE-CONTROL OUT	SI	1	1	1
6	DB93-09495E	WIRE-POWER	AWG16, BRN, SKYBLU	0	0	1
	DB93-09495C	WIRE-POWER	AWG16, BRN, SKYBLU	1	1	0
7	DB93-09496A	WIRE-COMUNICATION	AWG22, RED, BLU	1	1	1
8	DB93-09494A	WIRE-EARTH	AWG20, GRNYEL	0	1	1
	DB93-09494C	WIRE-EARTH	AWG20, GRNYEL	1	0	0
9	DB61-00250A	HOLDER-WIRE CLAMP	HOLDER-WIRE CLAMP	2	2	2
10	6002-000214	SCREW	TH, +, -, 1, M4.0, L16, ZPC(BLK)	4	4	4
11	6001-001054	SCREW	M4, L25	2	2	2
12	6009-001001	SCREW	TH+	4	4	4
13	6002-000555	SCREW	M4, L25	2	2	2
14	DB95-01712L	ASSY NOISE ABSORBER	*	0	0	1
	DB95-01712M	ASSY NOISE ABSORBER	*	1	1	0
15	DB98-33292A	LABEL	COMM	1	1	1
16	DB62-09724A	HEAT SINK	O1	1	0	0
	DB62-09725A	HEAT SINK	SI	0	1	1
17	DB93-10952A	ASSY PCB MAIN	SI	1	1	DB93-10952C
	DB93-09497B	WIRE-COMP	AWG16, RED, BLU, YEL	0	0	1
18	DB93-09497C	WIRE-COMP	AWG16, RED, BLU, YEL	1	1	1
	DB93-09493B	WIRE-REACTOR	AWG16, WHT	0	0	1
19	DB93-09493C	WIRE-REACTOR	AWG16, WHT	1	1	0
	6002-000630	SCREW	PH +	1	1	1
21	6002-000527	SCREW	M4, L10	1	1	1
22	DB91-00306A	ASSY-SCREW MACHINE	M3, L16	4	4	4
23	0205-001027	THERAL GREASE	NYLON66	2g	2g	2g
24	DB65-10088D	CABLE-TIE		0	0	0
25	DB62-04956E	INSULATION-COND IN		1	0	0
26	DB98-33293A	LABEL	POWER	1	1	1

6. Electrical Parts List(09K)

INDOOR MAIN PCB(DB93-10859L)

Parts Code	Location	Description	Specification	Q'TY
0402-000137	D101	DIODE-RECTIFIER	1N4007, 1000V, 1A, DO-41, TP	1
2001-000429	R901	R-CARBON	1Kohm, 5%, 1/8W, AA, TP, 1. 8x3. 2mm	1
2002-001104	R108	R-COMPOSITION	12Mohm, 5%, 1/2W, AA, TP, 3. 4x9mm	1
2002-001104	R109	R-COMPOSITION	12Mohm, 5%, 1/2W, AA, TP, 3. 4x9mm	1
2401-000480	C106	C-AL	10uF, 20%, 50V, GP, TP, 5x11, 5	1
2401-000807	C111	C-AL	220uF, 20%, 16V, GP, TP, 8x11. 5, 5	1
2401-002619	C105	C-AL	47uF, 20%, 25V, GP, TP, 5x11, 5	1
3812-001283	J10	WIRE-NO SHEATH CU	FE+CU+SN, 300V, 52mm (TAPING), 1/0. 6mm	1
3812-001283	J11	WIRE-NO SHEATH CU	FE+CU+SN, 300V, 52mm (TAPING), 1/0. 6mm	1
3812-001283	J13	WIRE-NO SHEATH CU	FE+CU+SN, 300V, 52mm (TAPING), 1/0. 6mm	1
3812-001283	J14	WIRE-NO SHEATH CU	FE+CU+SN, 300V, 52mm (TAPING), 1/0. 6mm	1
3812-001283	J15	WIRE-NO SHEATH CU	FE+CU+SN, 300V, 52mm (TAPING), 1/0. 6mm	1
3812-001283	J16	WIRE-NO SHEATH CU	FE+CU+SN, 300V, 52mm (TAPING), 1/0. 6mm	1
3812-001283	J17	WIRE-NO SHEATH CU	FE+CU+SN, 300V, 52mm (TAPING), 1/0. 6mm	1
3812-001283	J20	WIRE-NO SHEATH CU	FE+CU+SN, 300V, 52mm (TAPING), 1/0. 6mm	1
3812-001283	J22	WIRE-NO SHEATH CU	FE+CU+SN, 300V, 52mm (TAPING), 1/0. 6mm	1
3812-001283	J23	WIRE-NO SHEATH CU	FE+CU+SN, 300V, 52mm (TAPING), 1/0. 6mm	1
3812-001283	J25	WIRE-NO SHEATH CU	FE+CU+SN, 300V, 52mm (TAPING), 1/0. 6mm	1
3812-001283	J29	WIRE-NO SHEATH CU	FE+CU+SN, 300V, 52mm (TAPING), 1/0. 6mm	1
3812-001283	J3	WIRE-NO SHEATH CU	FE+CU+SN, 300V, 52mm (TAPING), 1/0. 6mm	1
3812-001283	J31	WIRE-NO SHEATH CU	FE+CU+SN, 300V, 52mm (TAPING), 1/0. 6mm	1
3812-001283	J32	WIRE-NO SHEATH CU	FE+CU+SN, 300V, 52mm (TAPING), 1/0. 6mm	1
3812-001283	J33	WIRE-NO SHEATH CU	FE+CU+SN, 300V, 52mm (TAPING), 1/0. 6mm	1
3812-001283	J34	WIRE-NO SHEATH CU	FE+CU+SN, 300V, 52mm (TAPING), 1/0. 6mm	1
3812-001283	J4	WIRE-NO SHEATH CU	FE+CU+SN, 300V, 52mm (TAPING), 1/0. 6mm	1
3812-001283	J5	WIRE-NO SHEATH CU	FE+CU+SN, 300V, 52mm (TAPING), 1/0. 6mm	1
3812-001283	J6	WIRE-NO SHEATH CU	FE+CU+SN, 300V, 52mm (TAPING), 1/0. 6mm	1
3812-001283	J7	WIRE-NO SHEATH CU	FE+CU+SN, 300V, 52mm (TAPING), 1/0. 6mm	1
3812-001283	J8	WIRE-NO SHEATH CU	FE+CU+SN, 300V, 52mm (TAPING), 1/0. 6mm	1
3812-001283	J9	WIRE-NO SHEATH CU	FE+CU+SN, 300V, 52mm (TAPING), 1/0. 6mm	1
3812-001283	JP RY74	WIRE-NO SHEATH CU	FE+CU+SN, 300V, 52mm (TAPING), 1/0. 6mm	1
3812-001283	JPNTC	WIRE-NO SHEATH CU	FE+CU+SN, 300V, 52mm (TAPING), 1/0. 6mm	1
6042-000001	E703	EYELET	ID2. 2, OD2. 7, L3. 1, NI+SN, BSP3-1/2H	1
6042-000001	E704	EYELET	ID2. 2, OD2. 7, L3. 1, NI+SN, BSP3-1/2H	1
6042-000001	E705	EYELET	ID2. 2, OD2. 7, L3. 1, NI+SN, BSP3-1/2H	1
6042-000001	E706	EYELET	ID2. 2, OD2. 7, L3. 1, NI+SN, BSP3-1/2H	1
6042-000001	E707	EYELET	ID2. 2, OD2. 7, L3. 1, NI+SN, BSP3-1/2H	1
6042-000001	E708	EYELET	ID2. 2, OD2. 7, L3. 1, NI+SN, BSP3-1/2H	1
6042-000001	E711	EYELET	ID2. 2, OD2. 7, L3. 1, NI+SN, BSP3-1/2H	1
6042-000001	E712	EYELET	ID2. 2, OD2. 7, L3. 1, NI+SN, BSP3-1/2H	1
6042-000002	E101	EYELET	ID1. 5, OD2, L2. 8, NI+SN, BSP3-1/2H	1
6042-000002	E102	EYELET	ID1. 5, OD2, L2. 8, NI+SN, BSP3-1/2H	1
6042-000002	E103	EYELET	ID1. 5, OD2, L2. 8, NI+SN, BSP3-1/2H	1
6042-000002	E104	EYELET	ID1. 5, OD2, L2. 8, NI+SN, BSP3-1/2H	1

6042-000002	E701	EYELET	ID1. 5, OD2, L2. 8, NI+SN, BSP3-1/2H	1
6042-000002	E702	EYELET	ID1. 5, OD2, L2. 8, NI+SN, BSP3-1/2H	1
6042-000002	E709	EYELET	ID1. 5, OD2, L2. 8, NI+SN, BSP3-1/2H	1
6042-000002	E710	EYELET	ID1. 5, OD2, L2. 8, NI+SN, BSP3-1/2H	1
DB41-00971A	PCB	PCB MAIN-IN	11R_RAC_STD_AC,FR-1, 1, T1. 6, 90*120, 2	1
0402-001192	D103	DIODE-RECTIFIER	ES2D, 200V, 2A, SMB, TP	1
0402-001298	BD71	DIODE-BRIDGE	DF06S, 600V, 1A, SMD-4, TP	1
0402-001427	D102	DIODE-RECTIFIER	ES1D, 200V, 1A, D0-214AC, TP	1
0403-000258	ZD02	DIODE-ZENER	BZX84C5V6, 5. 2-6V, 225mW, SOT-23, TP	1
0403-001285	ZD01	DIODE-ZENER	BZX84-C11, 10. 4-11. 6V, 350mW, SOT-23, TP	1
0501-000534	Q401	TR-SMALL SIGNAL	2SC2412K, NPN, 200mW, SOT-23, TP, 180-390	1
0501-000534	Q601	TR-SMALL SIGNAL	2SC2412K, NPN, 200mW, SOT-23, TP, 180-390	1
0504-001064	Q101	TR-DIGITAL	DTC114EKA, NPN, 200mW, 10K/10K, SOT-23, TP	1
0504-001064	Q602	TR-DIGITAL	DTC114EKA, NPN, 200mW, 10K/10K, SOT-23, TP	1
0506-000175	IC05	TR-ARRAY	2003, NPN, 7, 1W, SOP-16, ST, 1000	1
0604-001002	PC01	PHOTO-COUPLER	TR, 100-600%, 200mW, SOP-4, TP	1
0604-001172	PC02	PHOTO-COUPLER	TR, 150-300, 200mW, SOP, TP	1
1103-001431	IC03	IC-EEPROM	AT24C08BN, 8Kbit, 1Kx8, SOP, 8P, 4. 9x3. 9mm, 1. 8/5. 5, -40to+85C, 18uA, TP	1
1203-006245	IC06	IC-VOL. DETECTOR	KIA7033AT, TSM, 3P, 2. 9x1. 6x0. 7mm, PLASTIC, 3. 3V, 350mW, -30to+85C, TP	1
2007-000033	J12	R-CHIP	0ohm, 5%, 1/4W, TP, 3216	1
2007-000033	J18	R-CHIP	0ohm, 5%, 1/4W, TP, 3216	1
2007-000033	J19	R-CHIP	0ohm, 5%, 1/4W, TP, 3216	1
2007-000033	J2	R-CHIP	0ohm, 5%, 1/4W, TP, 3216	1
2007-000033	J21	R-CHIP	0ohm, 5%, 1/4W, TP, 3216	1
2007-000033	J24	R-CHIP	0ohm, 5%, 1/4W, TP, 3216	1
2007-000033	J26	R-CHIP	0ohm, 5%, 1/4W, TP, 3216	1
2007-000033	J27	R-CHIP	0ohm, 5%, 1/4W, TP, 3216	1
2007-000033	J28	R-CHIP	0ohm, 5%, 1/4W, TP, 3216	1
2007-000033	J30	R-CHIP	0ohm, 5%, 1/4W, TP, 3216	1
2007-000074	R110	R-CHIP	100ohm, 5%, 1/10W, TP, 1608	1
2007-000076	R403	R-CHIP	330ohm, 5%, 1/10W, TP, 1608	1
2007-000076	R404	R-CHIP	330ohm, 5%, 1/10W, TP, 1608	1
2007-000076	R601	R-CHIP	330ohm, 5%, 1/10W, TP, 1608	1
2007-000076	R602	R-CHIP	330ohm, 5%, 1/10W, TP, 1608	1
2007-000077	R112	R-CHIP	470ohm, 5%, 1/10W, TP, 1608	1
2007-000078	R206	R-CHIP	1Kohm, 5%, 1/10W, TP, 1608	1
2007-000078	R303	R-CHIP	1Kohm, 5%, 1/10W, TP, 1608	1
2007-000078	R304	R-CHIP	1Kohm, 5%, 1/10W, TP, 1608	1
2007-000078	R405	R-CHIP	1Kohm, 5%, 1/10W, TP, 1608	1
2007-000078	R407	R-CHIP	1Kohm, 5%, 1/10W, TP, 1608	1
2007-000081	R111	R-CHIP	2. 7Kohm, 5%, 1/10W, TP, 1608	1
2007-000084	R205	R-CHIP	4. 7Kohm, 5%, 1/10W, TP, 1608	1
2007-000084	R301	R-CHIP	4. 7Kohm, 5%, 1/10W, TP, 1608	1
2007-000084	R302	R-CHIP	4. 7Kohm, 5%, 1/10W, TP, 1608	1
2007-000084	R502	R-CHIP	4. 7Kohm, 5%, 1/10W, TP, 1608	1
2007-000084	R503	R-CHIP	4. 7Kohm, 5%, 1/10W, TP, 1608	1
2007-000084	R504	R-CHIP	4. 7Kohm, 5%, 1/10W, TP, 1608	1
2007-000087	R406	R-CHIP	6. 8Kohm, 5%, 1/10W, TP, 1608	1
2007-000090	R306	R-CHIP	10Kohm, 5%, 1/10W, TP, 1608	1
2007-000097	R902	R-CHIP	47Kohm, 5%, 1/10W, TP, 1608	1

2007-000109	R501	R-CHIP	1Mohm, 5%, 1/10W, TP, 1608	1
2007-000481	R101	R-CHIP	1Mohm, 5%, 1/4W, TP, 3216	1
2007-000481	R102	R-CHIP	1Mohm, 5%, 1/4W, TP, 3216	1
2007-000481	R103	R-CHIP	1Mohm, 5%, 1/4W, TP, 3216	1
2007-000781	R106	R-CHIP	33ohm, 5%, 1/8W, TP, 2012	1
2007-001068	R401	R-CHIP	6. 8Kohm, 1%, 1/10W, TP, 1608	1
2007-001068	R402	R-CHIP	6. 8Kohm, 1%, 1/10W, TP, 1608	1
2007-001074	R107	R-CHIP	6. 8ohm, 5%, 1/8W, TP, 2012	1
2007-001318	R305	R-CHIP	1Kohm, 5%, 1/4W, TP, 3216	1
2007-007385	R113	R-CHIP	1. 2Mohm, 1%, 1/4w, TP, 3216	1
2203-000257	C403	C-CER, CHIP	10nF, 10%, 50V, X7R, TP, 1608	1
2203-000257	C501	C-CER, CHIP	10nF, 10%, 50V, X7R, TP, 1608	1
2203-000440	C901	C-CER, CHIP	1nF, 10%, 50V, X7R, TP, 1608	1
2203-005249	C104	C-CER, CHIP	100nF, 10%, 50V, X7R, TP, 1608	1
2203-005249	C110	C-CER, CHIP	100nF, 10%, 50V, X7R, TP, 1608	1
2203-005249	C112	C-CER, CHIP	100nF, 10%, 50V, X7R, TP, 1608	1
2203-005249	C113	C-CER, CHIP	100nF, 10%, 50V, X7R, TP, 1608	1
2203-005249	C201	C-CER, CHIP	100nF, 10%, 50V, X7R, TP, 1608	1
2203-005249	C301	C-CER, CHIP	100nF, 10%, 50V, X7R, TP, 1608	1
2203-005249	C302	C-CER, CHIP	100nF, 10%, 50V, X7R, TP, 1608	1
2203-005249	C303	C-CER, CHIP	100nF, 10%, 50V, X7R, TP, 1608	1
2203-005249	C401	C-CER, CHIP	100nF, 10%, 50V, X7R, TP, 1608	1
2203-005249	C402	C-CER, CHIP	100nF, 10%, 50V, X7R, TP, 1608	1
2203-005249	C404	C-CER, CHIP	100nF, 10%, 50V, X7R, TP, 1608	1
2203-005249	C502	C-CER, CHIP	100nF, 10%, 50V, X7R, TP, 1608	1
2203-005249	C503	C-CER, CHIP	100nF, 10%, 50V, X7R, TP, 1608	1
2203-005249	C504	C-CER, CHIP	100nF, 10%, 50V, X7R, TP, 1608	1
DB91-01168A	IC04	ASSY-MIC	Maldive Low Cost Inv, STM-1035-0A, S3C84VBXZZ-QT8B, 64QFP, ROM 64KB	1
DB09-00588A	-	IC MICOM	S3F84VBXZZ-QT8B, 64QFP, DC5V, 12MHz, QFP, 8BIT, 8BIT, QFP, QFP, 8BIT, -40~+85, 64Kbyte	1
1203-000274	IC02	IC-POSI. FIXED REG.	7805, TO-220, 3P, -, PLASTIC, 4. 8/5	1
1203-006089	IC01	IC-PWM CONTROLLER	TOP253PN, DIP, 7P, 6. 35x9. 57mm, PLASTIC, -0. 3V/700V, 15W, -40Cto+150C, 1. 37A, ST	1
1405-000160	VA71	VARISTOR	680V, 4500A, 17. 5x6. 5mm, TP	1
2003-000598	R202	R-METAL OXIDE (S)	24Kohm, 5%, 2W, AA, TP, 4. 3x12mm	1
2003-000706	R105	R-METAL OXIDE (S)	47Kohm, 5%, 2W, AA, TP, 4. 3x12mm	1
2003-002409	R201	R-METAL OXIDE (S)	24Kohm, 5%, 2W, AF, TP, 4x11mm	1
2201-000983	C103	C-CERAMIC, DISC	1nF, 10%, 2000V, Y5P, BK, 9x5mm, 7. 5mm	1
2201-000987	C107	C-CERAMIC, DISC	2. 2nF, 20%, 400V, Y5U, TP, 12. 5x6mm, 10mm	1
2201-000987	C108	C-CERAMIC, DISC	2. 2nF, 20%, 400V, Y5U, TP, 12. 5x6mm, 10mm	1
2301-001915	CR71	C-FILM, LEAD	1200nF, +10-5%, 450V, BK, 37x18x30mm	1
2301-002032	XC71	C-FILM, LEAD-PPF	100nF, 10%, 275V, TP, 12. 5X6X12. 0	1
2301-002032	XC72	C-FILM, LEAD-PPF	100nF, 10%, 275V, TP, 12. 5X6X12. 0	1
2401-001998	C109	C-AL	1000uF, 20%, 25V, GP, TP, 10x20, 5mm	1
2401-003763	C101	C-AL	33uF, 20%, 450V, GP, TP, 16x31. 5mm, 5mm	1
2401-003763	C102	C-AL	33uF, 20%, 450V, GP, TP, 16x31. 5mm, 5mm	1
2802-001198	X501	RESONATOR-CERAMIC	10MHz, 0. 5%, BK, 8x3x5. 5mm	1

ElectricalPartList

3002-001129	BZ61	BUZZER-PIEZO	85dB, 2KHz, BK	1
3501-001268	RY71	RELAY-POWER	12V, 0.9W, 2500mA, 1FormA, 20ms, 10ms	1
3502-000115	SS71	SSR	12V, 2A, 1ms, 1ms	1
3502-000115	SS72	SSR	12V, 2A, 1ms, 1ms	1
3601-001209	F702	FUSE-RADIAL LEAD	250V, 1A, TIME-LAG, -, 8.5x8mm	1
3601-001288	F701	FUSE-AXIAL LEAD	250V, 2.5A, TIME-LAG, CERAMIC-TUBE, 5.2x20mm	1
3711-000260	CN71	HEADER-BOARD TO CABLE	1WALL, 3P, 1R, 7.92mm, STRAIGHT, SN, BLU	1
3711-000262	CN72	HEADER-BOARD TO CABLE	1WALL, 3P, 1R, 7.92MM, STRAIGHT, SN, WHT	1
3711-000879	CN44	HEADER-BOARD TO CABLE	BOX, 3P, 1R, 2.5mm, STRAIGHT, SN, BLU	1
3711-000941	CN81	HEADER-BOARD TO CABLE	BOX, 4P, 1R, 2.5mm, STRAIGHT, SN, YEL	1
3711-004379	CN43	HEADER-BOARD TO CABLE	BOX, 4P, 1R, 2mm, STRAIGHT, SN, WHT	1
3711-004484	CN61	HEADER-BOARD TO CABLE	BOX, 5P, 1R, 2mm, STRAIGHT, SN, WHT	1
3711-004712	CN91	HEADER-BOARD TO CABLE	BOX, 9P, 1R, 2mm, STRAIGHT, SN, WHT	1
3711-007067	CN31	HEADER-BOARD TO CABLE	BOX, 6P, 1R, 2mm, STRAIGHT, SN, BLK	1
DB26-00115A	ST11	TRANS SWITCHING	DB26-00115A, TOP253PN, PL-7, PM-7, DMR40, EE1916, 50/60Hz, 620uH	1
DB27-00017A	FT71	COIL CHOKE	USAV-07153, UU1116, 15.0mH, +50~-30%, 1.3ohm, 15mH, 105, 20*18mm, 13, 0.6, BK, -25°C~+85°C	1
DB67-00942A	VA71-CAP	CAP	VIVALDI-P/J, SHP2, -, -, -, GREEN, SSEC	1
DB93-10917A	CN11	ASSY CONNECTOR WIRE-PCB	FORTE 1, AWG#28	1

6. Electrical Parts List

INDOOR MAIN PCB(12K)

Parts Code	Design Loc	Parts Description	Spec.	Quantity
1203-000274	IC02	IC-POSI. FIXED REG.	7805, TO-220, 3P, -, PLASTIC, 4.8/5	1
1203-006089	IC01	IC-PWM CONTROLLER	TOP253PN, DIP, 7P, 6.35x9.57mm, PLASTIC, -0.3V/700V, 15W, -40Cto+150C, 1.37A, ST	1
1405-000160	VA71	VARISTOR	680V, 560Vdc, 4500A, 17.5x6.5mm, TP, 1120V, 250pF	1
2201-000983	C103	C-CERAMIC, DISC	1nF, 10%, 2000V, Y5P, TP, 9x5mm, 7.5mm	1
2201-000987	C107	C-CERAMIC, DISC	2.2nF, 20%, 400V, Y5U, TP, 12.5x6mm, 10mm	1
2201-000987	C108	C-CERAMIC, DISC	2.2nF, 20%, 400V, Y5U, TP, 12.5x6mm, 10mm	1
2301-001915	CR71	C-FILM, LEAD	1200nF, +10-5%, 450V, BK, 37x18x26.5mm	1
2301-002032	XC72	C-FILM, LEAD-PPF	100nF, 10%, 275V, TP, 12.5X6X12.0	1
2401-001998	C109	C-AL	1000uF, 20%, 25V, GP, TP, 10x20, 5mm	1
2401-003763	C101	C-AL	33uF, 20%, 450V, GP, TP, 16x25mm, 5mm	1
2401-003763	C102	C-AL	33uF, 20%, 450V, GP, TP, 16x25mm, 5mm	1
3002-001129	BZ61	BUZZER-PIEZO	85dB, 2KHz, BK	1
3501-001268	RY71	RELAY-POWER	12V, 0.9W, 25000mA, 1FormA, 20ms, 10ms	1
3502-000115	SS71	SSR	12V, 2A, 1ms, 1ms	1
3502-001087	SS72	SSR	12V, 2A, 0.2ms	1
3601-001288	F701	FUSE-AXIAL LEAD	250V, 2.5A, TIME-LAG, CERAMIC-	1
3711-000260	CN71	HEADER-BOARD TO CABLE	1WALL, 3P, 1R, 7.92mm, STRAIGHT, SN, BLU	1
3711-000262	CN72	HEADER-BOARD TO CABLE	1WALL, 3P, 1R, 7.92MM, STRAIGHT, SN, WHT	1
3711-000879	CN44	HEADER-BOARD TO CABLE	BOX, 3P, 1R, 2.5mm, STRAIGHT, SN, BLU	1
3711-000941	CN81	HEADER-BOARD TO CABLE	BOX, 4P, 1R, 2.5mm, STRAIGHT, SN, YEL	1
3711-004349	CN42	HEADER-BOARD TO CABLE	BOX, 3P, 1R, 2mm, STRAIGHT, SN, WHT	1
3711-004379	CN43	HEADER-BOARD TO CABLE	BOX, 4P, 1R, 2mm, STRAIGHT, SN, WHT	1
3711-004484	CN61	HEADER-BOARD TO CABLE	BOX, 5P, 1R, 2mm, STRAIGHT, SN, WHT	1
3711-004712	CN91	HEADER-BOARD TO CABLE	BOX, 9P, 1R, 2mm, STRAIGHT, SN, WHT	1
3711-007067	CN31	HEADER-BOARD TO CABLE	BOX, 6P, 1R, 2mm, STRAIGHT, SN, BLK	1
DB26-00115A	ST11	TRANS SWITCHING	DB26-00115A, TOP253PN, PL-7, PM-7, DMR40, EE1916, 50/60Hz, 620uH	1
DB27-00017A	FT71	COIL CHOKE	USAV-07153, UU1116, 15.0mH, +50~-30%, 1.3ohm, 15mH, 105, 20*18mm, 13, 0.6, BK, -25°C~+85°C	1
DB67-00942A	VA71-1	CAP	VIVALDI-P/J, SHP2, -, -, -, GREEN, SSEC	1
DB68-02809A	-	LABEL BAR CODE	45, 15, E-PASS	1
0402-000137	D101	DIODE-RECTIFIER	1N4007, 1000V, 1A, DO-41, TP	1
1404-001274	NTC1	THERMISTOR-NTC	22ohm, 1.4A, 3100K, 9.5mW/C, -, 7.0, -	1
2001-000429	R901	R-CARBON	1Kohm, 5%, 1/8W, AA, TP, 1.8x3.2mm	1
2002-001104	R108	R-COMPOSITION	12Mohm, 5%, 1/2W, AA, TP, 3.4x9mm	1
2002-001104	R109	R-COMPOSITION	12Mohm, 5%, 1/2W, AA, TP, 3.4x9mm	1
2003-000598	R202	R-METAL OXIDE (S)	24Kohm, 5%, 2W, AA, TP, 3.8x12mm	1
2003-000706	R105	R-METAL OXIDE (S)	47Kohm, 5%, 2W, AA, TP, 3.8x12mm	1
2003-002409	R201	R-METAL OXIDE (S)	24Kohm, 5%, 2W, AF, TP, 3.8x12mm	1
2401-000480	C106	C-AL	10uF, 20%, 50V, GP, TP, 5x11, 5	1
2401-000832	C111	C-AL	220uF, 20%, 25V, GP, TP, 8x11.5, 5	1
2401-002619	C105	C-AL	47uF, 20%, 25V, GP, TP, 5x11, 5	1
2802-001198	X501	RESONATOR-CERAMIC	10MHz, 0.5%, BK, 8x3x5.5mm	1
3601-001209	F702	FUSE-RADIAL LEAD	250V, 1A, TIME-LAG, -, 8.5x8mm	1

Electrical Part List

3812-001283	J10	WIRE-NO SHEATH CU	FE+CU+SN, 300V, 52mm (TAPING), 1/0.6mm	1
3812-001283	J11	WIRE-NO SHEATH CU	FE+CU+SN, 300V, 52mm (TAPING), 1/0.6mm	1
3812-001283	J13	WIRE-NO SHEATH CU	FE+CU+SN, 300V, 52mm (TAPING), 1/0.6mm	1
3812-001283	J14	WIRE-NO SHEATH CU	FE+CU+SN, 300V, 52mm (TAPING), 1/0.6mm	1
3812-001283	J15	WIRE-NO SHEATH CU	FE+CU+SN, 300V, 52mm (TAPING), 1/0.6mm	1
3812-001283	J16	WIRE-NO SHEATH CU	FE+CU+SN, 300V, 52mm (TAPING), 1/0.6mm	1
3812-001283	J17	WIRE-NO SHEATH CU	FE+CU+SN, 300V, 52mm (TAPING), 1/0.6mm	1
3812-001283	J20	WIRE-NO SHEATH CU	FE+CU+SN, 300V, 52mm (TAPING), 1/0.6mm	1
3812-001283	J22	WIRE-NO SHEATH CU	FE+CU+SN, 300V, 52mm (TAPING), 1/0.6mm	1
3812-001283	J23	WIRE-NO SHEATH CU	FE+CU+SN, 300V, 52mm (TAPING), 1/0.6mm	1
3812-001283	J25	WIRE-NO SHEATH CU	FE+CU+SN, 300V, 52mm (TAPING), 1/0.6mm	1
3812-001283	J29	WIRE-NO SHEATH CU	FE+CU+SN, 300V, 52mm (TAPING), 1/0.6mm	1
3812-001283	J3	WIRE-NO SHEATH CU	FE+CU+SN, 300V, 52mm (TAPING), 1/0.6mm	1
3812-001283	J31	WIRE-NO SHEATH CU	FE+CU+SN, 300V, 52mm (TAPING), 1/0.6mm	1
3812-001283	J32	WIRE-NO SHEATH CU	FE+CU+SN, 300V, 52mm (TAPING), 1/0.6mm	1
3812-001283	J33	WIRE-NO SHEATH CU	FE+CU+SN, 300V, 52mm (TAPING), 1/0.6mm	1
3812-001283	J34	WIRE-NO SHEATH CU	FE+CU+SN, 300V, 52mm (TAPING), 1/0.6mm	1
3812-001283	J4	WIRE-NO SHEATH CU	FE+CU+SN, 300V, 52mm (TAPING), 1/0.6mm	1
3812-001283	J5	WIRE-NO SHEATH CU	FE+CU+SN, 300V, 52mm (TAPING), 1/0.6mm	1
3812-001283	J6	WIRE-NO SHEATH CU	FE+CU+SN, 300V, 52mm (TAPING), 1/0.6mm	1
3812-001283	J7	WIRE-NO SHEATH CU	FE+CU+SN, 300V, 52mm (TAPING), 1/0.6mm	1
3812-001283	J8	WIRE-NO SHEATH CU	FE+CU+SN, 300V, 52mm (TAPING), 1/0.6mm	1
3812-001283	J9	WIRE-NO SHEATH CU	FE+CU+SN, 300V, 52mm (TAPING), 1/0.6mm	1
3812-001283	JPRY74	WIRE-NO SHEATH CU	FE+CU+SN, 300V, 52mm (TAPING), 1/0.6mm	1
6042-000001	ECN71-1	EYELET	ID2. 2, OD2. 7, L3. 1, NI+SN, BSP3-1/2H	1
6042-000001	ECN71-2	EYELET	ID2. 2, OD2. 7, L3. 1, NI+SN, BSP3-1/2H	1
6042-000001	ECN72-1	EYELET	ID2. 2, OD2. 7, L3. 1, NI+SN, BSP3-1/2H	1
6042-000001	ECN72-2	EYELET	ID2. 2, OD2. 7, L3. 1, NI+SN, BSP3-1/2H	1
6042-000001	ERY71-1	EYELET	ID2. 2, OD2. 7, L3. 1, NI+SN, BSP3-1/2H	1
6042-000001	ERY71-2	EYELET	ID2. 2, OD2. 7, L3. 1, NI+SN, BSP3-1/2H	1
6042-000001	ERY71-3	EYELET	ID2. 2, OD2. 7, L3. 1, NI+SN, BSP3-1/2H	1
6042-000001	ERY71-4	EYELET	ID2. 2, OD2. 7, L3. 1, NI+SN, BSP3-1/2H	1
6042-000002	EC101-1	EYELET	ID1. 5, OD2, L2. 8, NI+SN, BSP3-1/2H	1
6042-000002	EC101-2	EYELET	ID1. 5, OD2, L2. 8, NI+SN, BSP3-1/2H	1
6042-000002	EC102-1	EYELET	ID1. 5, OD2, L2. 8, NI+SN, BSP3-1/2H	1
6042-000002	EC102-2	EYELET	ID1. 5, OD2, L2. 8, NI+SN, BSP3-1/2H	1
6042-000002	ECR71-1	EYELET	ID1. 5, OD2, L2. 8, NI+SN, BSP3-1/2H	1
6042-000002	ECR71-2	EYELET	ID1. 5, OD2, L2. 8, NI+SN, BSP3-1/2H	1
6042-000002	EF701-1	EYELET	ID1. 5, OD2, L2. 8, NI+SN, BSP3-1/2H	1
6042-000002	EF701-2	EYELET	ID1. 5, OD2, L2. 8, NI+SN, BSP3-1/2H	1
0201-002119	-	ADHESIVE-A. C. F	HT-130DL, RED, 550~650, SMD GLUE	2.50E-04
0402-001192	D103	DIODE-RECTIFIER	ES2D, 200V, 2A, SMB, TP	1
0402-001298	BD71	DIODE-BRIDGE	DF06S, 600V, 1A, SMD-4, TP	1
0402-001427	D102	DIODE-RECTIFIER	ES1D, 200V, 1A, DO-214AC, TP	1
0403-000258	ZD02	DIODE-ZENER	BZX84C5V6, 5.2-6V, 225mW, SOT-23, TP	1
0403-001285	ZD01	DIODE-ZENER	BZX84-C11, 10.4-11.6V, 350mW, SOT-23, TP	1
0501-000534	Q401	TR-SMALL SIGNAL	2SC2412K, NPN, 200mW, SOT-23, TP, 180-390	1
0501-000534	Q601	TR-SMALL SIGNAL	2SC2412K, NPN, 200mW, SOT-23, TP, 180-390	1

0504-001064	Q101	TR-DIGITAL	DTC114EKA, NPN, 200mW, 10K/10K, SOT-23, TP	1
0504-001064	Q602	TR-DIGITAL	DTC114EKA, NPN, 200mW, 10K/10K, SOT-23, TP	1
0506-000175	IC05	TR-ARRAY	2003, NPN, 7, 1W, SOP-16, ST, 1000	1
0604-001172	PC01	PHOTO-COUPLER	TR, 150-300, 200mW, SOP, TP	1
0604-001172	PC02	PHOTO-COUPLER	TR, 150-300, 200mW, SOP, TP	1
1103-001431	IC03	IC-EEPROM	AT24C08BN, 8Kbit, 1Kx8, SOP, 8P, 4. 9x3. 9mm, 1. 8/5. 5, -40to+85C, 18uA, TP	1
1203-006245	IC06	IC-VOL. DETECTOR	KIA7033AT, TSM, 3P, 2. 9x1. 6x0. 7mm, PLASTIC, 3. 3V, 350mW, -30to+85C, TP	1
2007-000033	J12	R-CHIP	0ohm, 5%, 1/4W, TP, 3216	1
2007-000033	J18	R-CHIP	0ohm, 5%, 1/4W, TP, 3216	1
2007-000033	J19	R-CHIP	0ohm, 5%, 1/4W, TP, 3216	1
2007-000033	J2	R-CHIP	0ohm, 5%, 1/4W, TP, 3216	1
2007-000033	J21	R-CHIP	0ohm, 5%, 1/4W, TP, 3216	1
2007-000033	J24	R-CHIP	0ohm, 5%, 1/4W, TP, 3216	1
2007-000033	J26	R-CHIP	0ohm, 5%, 1/4W, TP, 3216	1
2007-000033	J27	R-CHIP	0ohm, 5%, 1/4W, TP, 3216	1
2007-000033	J28	R-CHIP	0ohm, 5%, 1/4W, TP, 3216	1
2007-000033	J30	R-CHIP	0ohm, 5%, 1/4W, TP, 3216	1
2007-000074	R110	R-CHIP	100ohm, 5%, 1/10W, TP, 1608	1
2007-000076	R403	R-CHIP	330ohm, 5%, 1/10W, TP, 1608	1
2007-000076	R404	R-CHIP	330ohm, 5%, 1/10W, TP, 1608	1
2007-000076	R408	R-CHIP	330ohm, 5%, 1/10W, TP, 1608	1
2007-000076	R601	R-CHIP	330ohm, 5%, 1/10W, TP, 1608	1
2007-000076	R602	R-CHIP	330ohm, 5%, 1/10W, TP, 1608	1
2007-000077	R112	R-CHIP	470ohm, 5%, 1/10W, TP, 1608	1
2007-000078	R206	R-CHIP	1Kohm, 5%, 1/10W, TP, 1608	1
2007-000078	R303	R-CHIP	1Kohm, 5%, 1/10W, TP, 1608	1
2007-000078	R304	R-CHIP	1Kohm, 5%, 1/10W, TP, 1608	1
2007-000078	R405	R-CHIP	1Kohm, 5%, 1/10W, TP, 1608	1
2007-000078	R407	R-CHIP	1Kohm, 5%, 1/10W, TP, 1608	1
2007-000081	R111	R-CHIP	2. 7Kohm, 5%, 1/10W, TP, 1608	1
2007-000084	R205	R-CHIP	4. 7Kohm, 5%, 1/10W, TP, 1608	1
2007-000084	R301	R-CHIP	4. 7Kohm, 5%, 1/10W, TP, 1608	1
2007-000084	R302	R-CHIP	4. 7Kohm, 5%, 1/10W, TP, 1608	1
2007-000084	R502	R-CHIP	4. 7Kohm, 5%, 1/10W, TP, 1608	1
2007-000084	R503	R-CHIP	4. 7Kohm, 5%, 1/10W, TP, 1608	1
2007-000084	R504	R-CHIP	4. 7Kohm, 5%, 1/10W, TP, 1608	1
2007-000087	R406	R-CHIP	6. 8Kohm, 5%, 1/10W, TP, 1608	1
2007-000090	R306	R-CHIP	10Kohm, 5%, 1/10W, TP, 1608	1
2007-000097	R902	R-CHIP	47Kohm, 5%, 1/10W, TP, 1608	1
2007-000109	R501	R-CHIP	1Mohm, 5%, 1/10W, TP, 1608	1
2007-000476	R101	R-CHIP	1Mohm, 1%, 1/4W, TP, 3216	1
2007-000476	R102	R-CHIP	1Mohm, 1%, 1/4W, TP, 3216	1
2007-000476	R103	R-CHIP	1Mohm, 1%, 1/4W, TP, 3216	1
2007-000781	R106	R-CHIP	33ohm, 5%, 1/8W, TP, 2012	1
2007-001068	R401	R-CHIP	6. 8Kohm, 1%, 1/10W, TP, 1608	1
2007-001068	R402	R-CHIP	6. 8Kohm, 1%, 1/10W, TP, 1608	1

Electrical Part List

2007-001074	R107	R-CHIP	6.8ohm, 5%, 1/8W, TP, 2012	1
2007-001318	R305	R-CHIP	1Kohm, 5%, 1/4W, TP, 3216	1
2007-007385	R113	R-CHIP	1.2Mohm, 1%, 1/4w, TP, 3216	1
2203-000257	C403	C-CER, CHIP	10nF, 10%, 50V, X7R, TP, 1608	1
2203-000257	C501	C-CER, CHIP	10nF, 10%, 50V, X7R, TP, 1608	1
2203-000440	C901	C-CER, CHIP	1nF, 10%, 50V, X7R, TP, 1608	1
2203-005249	C104	C-CER, CHIP	100nF, 10%, 50V, X7R, TP, 1608	1
2203-005249	C110	C-CER, CHIP	100nF, 10%, 50V, X7R, TP, 1608	1
2203-005249	C112	C-CER, CHIP	100nF, 10%, 50V, X7R, TP, 1608	1
2203-005249	C113	C-CER, CHIP	100nF, 10%, 50V, X7R, TP, 1608	1
2203-005249	C201	C-CER, CHIP	100nF, 10%, 50V, X7R, TP, 1608	1
2203-005249	C301	C-CER, CHIP	100nF, 10%, 50V, X7R, TP, 1608	1
2203-005249	C302	C-CER, CHIP	100nF, 10%, 50V, X7R, TP, 1608	1
2203-005249	C303	C-CER, CHIP	100nF, 10%, 50V, X7R, TP, 1608	1
2203-005249	C401	C-CER, CHIP	100nF, 10%, 50V, X7R, TP, 1608	1
2203-005249	C402	C-CER, CHIP	100nF, 10%, 50V, X7R, TP, 1608	1
2203-005249	C502	C-CER, CHIP	100nF, 10%, 50V, X7R, TP, 1608	1
2203-005249	C503	C-CER, CHIP	100nF, 10%, 50V, X7R, TP, 1608	1
2203-005249	C504	C-CER, CHIP	100nF, 10%, 50V, X7R, TP, 1608	1
DB41-01102A	PCB	PCB MAIN-IN	11R_RAC_STD_AC, FR-1, T1.6, 90*120, 2	1
DB91-01168D	IC04	ASSY-MIC	Maldiv Low Cost Inv Micom, STM-1035-DA, S3F84VBXZZ-QT8B, 64QFP, ROM 64KB	1
DB09-00588A	-	IC MICOM	S3F84VBXZZ-QT8B, 64QFP, DC5V, 12MHz, QFP, 8BIT, 8BIT, QFP, QFP, 8BIT, -40~+85, 64Kbyte	1
DB98-31449A	-	ASSY-LABEL MICOM	QFP, 64P, WHT, 9*9	1
DB93-12824A	CN11	ASSY CONNECTOR WIRE	YBNH, 25045HP, 2P, UL1007, AWG26	1

6. Electrical Parts List(18K)

■ INDOOR MAIN PCB DB93-10956C

Parts Code	Location	Spec.	Quantity	Unit
DB93-11514A	-	LOW COST-PJT, SSEC	1	PC
0402-000137	D101	1N4007, 1000V, 1A, DO-41, TP	1	PC
0402-000137	D701	1N4007, 1000V, 1A, DO-41, TP	1	PC
2002-001104	R108	12Mohm, 5%, 1/2W, AA, TP, 3. 4x9mm	1	PC
2002-001104	R109	12Mohm, 5%, 1/2W, AA, TP, 3. 4x9mm	1	PC
2003-000706	R105	47Kohm, 5%, 2W, AA, TP, 4. 3x12mm	1	PC
2003-002409	R201	24Kohm, 5%, 2W, AF, TP, 4x11mm	1	PC
2003-002409	R202	24Kohm, 5%, 2W, AF, TP, 4x11mm	1	PC
2201-000983	C103	1nF, 10%, 2000V, Y5P, BK, 9x5mm, 7. 5mm	1	PC
2201-000987	C107	2. 2nF, 20%, 400V, Y5U, TP, 12. 5x6mm, 10mm	1	PC
2201-000987	C108	2. 2nF, 20%, 400V, Y5U, TP, 12. 5x6mm, 10mm	1	PC
2301-001220	XC71	100nF, 10%, 275V, BK, 18x6x12mm	1	PC
2301-001220	XC72	100nF, 10%, 275V, BK, 18x6x12mm	1	PC
2401-000027	C706	4. 7uF, 20%, 50V, GP, TP, 5x11, 5	1	PC
2401-000480	C106	10uF, 20%, 50V, GP, TP, 5x11, 5	1	PC
2401-000807	C111	220uF, 20%, 16V, GP, TP, 8x11. 5, 5	1	PC
2401-001998	C109	1000uF, 20%, 25V, GP, TP, 10x20, 5mm	1	PC
2401-002300	C701	47uF, 20%, 50V, GP, TP, 6. 3x11, 5mm	1	PC
2401-002300	C703	47uF, 20%, 50V, GP, TP, 6. 3x11, 5mm	1	PC
2401-002619	C105	47uF, 20%, 25V, GP, TP, 5x11, 5	1	PC
2401-004393	C101	100uF, 20%, 500V, -, BK, 25. 4x30mm, 10mm	1	PC
3601-001209	F702	250V, 1A, TIME-LAG, -, 8. 5x8mm	1	PC
3812-001283	J10	FE+CU+SN, 300V, 52mm (TAPING), 1/0. 6mm	1	PC
3812-001283	J11	FE+CU+SN, 300V, 52mm (TAPING), 1/0. 6mm	1	PC
3812-001283	J12	FE+CU+SN, 300V, 52mm (TAPING), 1/0. 6mm	1	PC
3812-001283	J13	FE+CU+SN, 300V, 52mm (TAPING), 1/0. 6mm	1	PC
3812-001283	J14	FE+CU+SN, 300V, 52mm (TAPING), 1/0. 6mm	1	PC
3812-001283	J15	FE+CU+SN, 300V, 52mm (TAPING), 1/0. 6mm	1	PC
3812-001283	J16	FE+CU+SN, 300V, 52mm (TAPING), 1/0. 6mm	1	PC
3812-001283	J17	FE+CU+SN, 300V, 52mm (TAPING), 1/0. 6mm	1	PC
3812-001283	J18	FE+CU+SN, 300V, 52mm (TAPING), 1/0. 6mm	1	PC
3812-001283	J19	FE+CU+SN, 300V, 52mm (TAPING), 1/0. 6mm	1	PC
3812-001283	J2	FE+CU+SN, 300V, 52mm (TAPING), 1/0. 6mm	1	PC
3812-001283	J20	FE+CU+SN, 300V, 52mm (TAPING), 1/0. 6mm	1	PC
3812-001283	J21	FE+CU+SN, 300V, 52mm (TAPING), 1/0. 6mm	1	PC
3812-001283	J22	FE+CU+SN, 300V, 52mm (TAPING), 1/0. 6mm	1	PC
3812-001283	J23	FE+CU+SN, 300V, 52mm (TAPING), 1/0. 6mm	1	PC
3812-001283	J24	FE+CU+SN, 300V, 52mm (TAPING), 1/0. 6mm	1	PC
3812-001283	J25	FE+CU+SN, 300V, 52mm (TAPING), 1/0. 6mm	1	PC
3812-001283	J26	FE+CU+SN, 300V, 52mm (TAPING), 1/0. 6mm	1	PC
3812-001283	J28	FE+CU+SN, 300V, 52mm (TAPING), 1/0. 6mm	1	PC
3812-001283	J29	FE+CU+SN, 300V, 52mm (TAPING), 1/0. 6mm	1	PC
3812-001283	J3	FE+CU+SN, 300V, 52mm (TAPING), 1/0. 6mm	1	PC
3812-001283	J30	FE+CU+SN, 300V, 52mm (TAPING), 1/0. 6mm	1	PC
3812-001283	J31	FE+CU+SN, 300V, 52mm (TAPING), 1/0. 6mm	1	PC
3812-001283	J32	FE+CU+SN, 300V, 52mm (TAPING), 1/0. 6mm	1	PC
3812-001283	J33	FE+CU+SN, 300V, 52mm (TAPING), 1/0. 6mm	1	PC
3812-001283	J34	FE+CU+SN, 300V, 52mm (TAPING), 1/0. 6mm	1	PC
3812-001283	J35	FE+CU+SN, 300V, 52mm (TAPING), 1/0. 6mm	1	PC
3812-001283	J36	FE+CU+SN, 300V, 52mm (TAPING), 1/0. 6mm	1	PC
3812-001283	J38	FE+CU+SN, 300V, 52mm (TAPING), 1/0. 6mm	1	PC
3812-001283	J4	FE+CU+SN, 300V, 52mm (TAPING), 1/0. 6mm	1	PC
3812-001283	J40	FE+CU+SN, 300V, 52mm (TAPING), 1/0. 6mm	1	PC
3812-001283	J42	FE+CU+SN, 300V, 52mm (TAPING), 1/0. 6mm	1	PC

Electrical Part List

Parts Code	Location	Spec.	Quantity	Unit
3812-001283	J43	FE+CU+SN, 300V, 52mm (TAPING), 1/0. 6mm	1	PC
3812-001283	J44	FE+CU+SN, 300V, 52mm (TAPING), 1/0. 6mm	1	PC
3812-001283	J45	FE+CU+SN, 300V, 52mm (TAPING), 1/0. 6mm	1	PC
3812-001283	J46	FE+CU+SN, 300V, 52mm (TAPING), 1/0. 6mm	1	PC
3812-001283	J49	FE+CU+SN, 300V, 52mm (TAPING), 1/0. 6mm	1	PC
3812-001283	J5	FE+CU+SN, 300V, 52mm (TAPING), 1/0. 6mm	1	PC
3812-001283	J50	FE+CU+SN, 300V, 52mm (TAPING), 1/0. 6mm	1	PC
3812-001283	J51	FE+CU+SN, 300V, 52mm (TAPING), 1/0. 6mm	1	PC
3812-001283	J52	FE+CU+SN, 300V, 52mm (TAPING), 1/0. 6mm	1	PC
3812-001283	J53	FE+CU+SN, 300V, 52mm (TAPING), 1/0. 6mm	1	PC
3812-001283	J54	FE+CU+SN, 300V, 52mm (TAPING), 1/0. 6mm	1	PC
3812-001283	J56	FE+CU+SN, 300V, 52mm (TAPING), 1/0. 6mm	1	PC
3812-001283	J58	FE+CU+SN, 300V, 52mm (TAPING), 1/0. 6mm	1	PC
3812-001283	J59	FE+CU+SN, 300V, 52mm (TAPING), 1/0. 6mm	1	PC
3812-001283	J6	FE+CU+SN, 300V, 52mm (TAPING), 1/0. 6mm	1	PC
3812-001283	J7	FE+CU+SN, 300V, 52mm (TAPING), 1/0. 6mm	1	PC
3812-001283	J71	FE+CU+SN, 300V, 52mm (TAPING), 1/0. 6mm	1	PC
3812-001283	J73	FE+CU+SN, 300V, 52mm (TAPING), 1/0. 6mm	1	PC
3812-001283	J8	FE+CU+SN, 300V, 52mm (TAPING), 1/0. 6mm	1	PC
3812-001283	J9	FE+CU+SN, 300V, 52mm (TAPING), 1/0. 6mm	1	PC
DB93-11515A	-	LOW COST-PJT, SSEC	1	PC
0402-001192	D103	ES2D, 200V, 2A, SMB, TP	1	PC
0402-001427	D102	ES1D, 200V, 1A, DO-214AC, TP	1	PC
0403-000258	ZD02	BZX84C5V6, 5. 2-6V, 225mW, SOT-23, TP	1	PC
0403-001285	ZD01	BZX84-C11, 10. 4-11. 6V, 350mW, SOT-23, TP	1	PC
0406-001204	CD81	SMBJ5. 0CA, 6. 4/-/7. 25V, 600W, SMB	1	PC
0406-001204	CD82	SMBJ5. 0CA, 6. 4/-/7. 25V, 600W, SMB	1	PC
0406-001204	CD83	SMBJ5. 0CA, 6. 4/-/7. 25V, 600W, SMB	1	PC
0501-000534	Q601	2SC2412K, NPN, 200mW, SOT-23, TP, 180-390	1	PC
0504-001064	Q101	DTC114EKA, NPN, 200mW, 10K/10K, SOT-23, TP	1	PC
0506-000175	IC05	2003, NPN, 7, 1W, SOP-16, ST, 1000	1	PC
0506-000175	IC06	2003, NPN, 7, 1W, SOP-16, ST, 1000	1	PC
0604-001002	PC01	TR, 100-600%, 200mW, SOP-4, TP	1	PC
0604-001002	PC03	TR, 100-600%, 200mW, SOP-4, TP	1	PC
0604-001002	PC04	TR, 100-600%, 200mW, SOP-4, TP	1	PC
0604-001002	PC05	TR, 100-600%, 200mW, SOP-4, TP	1	PC
0604-001172	PC02	TR, 150-300, 200mW, SOP, TP	1	PC
0801-000393	IC08	74HC86, OR	1	PC
1006-001325	IC07	ISL81487LIBZ, SO, 8P, 4. 9x3. 8	1	PC
1103-001431	IC03	AT24C08BN, 8Kbit, 1Kx8, SOP, 8P, 4. 9x3. 9mm,	1	PC
2007-000033	J1	0ohm, 5%, 1/4W, TP, 3216	1	PC
2007-000033	J27	0ohm, 5%, 1/4W, TP, 3216	1	PC
2007-000033	J37	0ohm, 5%, 1/4W, TP, 3216	1	PC
2007-000033	J39	0ohm, 5%, 1/4W, TP, 3216	1	PC
2007-000033	J41	0ohm, 5%, 1/4W, TP, 3216	1	PC
2007-000033	J47	0ohm, 5%, 1/4W, TP, 3216	1	PC
2007-000033	J48	0ohm, 5%, 1/4W, TP, 3216	1	PC
2007-000033	J55	0ohm, 5%, 1/4W, TP, 3216	1	PC
2007-000033	J57	0ohm, 5%, 1/4W, TP, 3216	1	PC
2007-000033	J60	0ohm, 5%, 1/4W, TP, 3216	1	PC
2007-000033	J62	0ohm, 5%, 1/4W, TP, 3216	1	PC
2007-000033	J63	0ohm, 5%, 1/4W, TP, 3216	1	PC
2007-000033	J64	0ohm, 5%, 1/4W, TP, 3216	1	PC
2007-000033	J65	0ohm, 5%, 1/4W, TP, 3216	1	PC
2007-000033	J66	0ohm, 5%, 1/4W, TP, 3216	1	PC
2007-000033	J67	0ohm, 5%, 1/4W, TP, 3216	1	PC
2007-000033	J68	0ohm, 5%, 1/4W, TP, 3216	1	PC
2007-000033	J69	0ohm, 5%, 1/4W, TP, 3216	1	PC
2007-000033	J70	0ohm, 5%, 1/4W, TP, 3216	1	PC
2007-000033	J72	0ohm, 5%, 1/4W, TP, 3216	1	PC

Parts Code	Location	Spec.	Quantity	Unit
2007-000070	R806	0ohm, 5%, 1/10W, TP, 1608	1	PC
2007-000074	R110	100ohm, 5%, 1/10W, TP, 1608	1	PC
2007-000074	R809	100ohm, 5%, 1/10W, TP, 1608	1	PC
2007-000074	R811	100ohm, 5%, 1/10W, TP, 1608	1	PC
2007-000076	R403	330ohm, 5%, 1/10W, TP, 1608	1	PC
2007-000076	R404	330ohm, 5%, 1/10W, TP, 1608	1	PC
2007-000076	R601	330ohm, 5%, 1/10W, TP, 1608	1	PC
2007-000076	R602	330ohm, 5%, 1/10W, TP, 1608	1	PC
2007-000077	R116	470ohm, 5%, 1/10W, TP, 1608	1	PC
2007-000078	R206	1Kohm, 5%, 1/10W, TP, 1608	1	PC
2007-000078	R706	1Kohm, 5%, 1/10W, TP, 1608	1	PC
2007-000078	R805	1Kohm, 5%, 1/10W, TP, 1608	1	PC
2007-000078	R812	1Kohm, 5%, 1/10W, TP, 1608	1	PC
2007-000078	R813	1Kohm, 5%, 1/10W, TP, 1608	1	PC
2007-000078	R903	1Kohm, 5%, 1/10W, TP, 1608	1	PC
2007-000081	R111	2.7Kohm, 5%, 1/10W, TP, 1608	1	PC
2007-000084	R205	4.7Kohm, 5%, 1/10W, TP, 1608	1	PC
2007-000084	R502	4.7Kohm, 5%, 1/10W, TP, 1608	1	PC
2007-000084	R503	4.7Kohm, 5%, 1/10W, TP, 1608	1	PC
2007-000084	R504	4.7Kohm, 5%, 1/10W, TP, 1608	1	PC
2007-000084	R707	4.7Kohm, 5%, 1/10W, TP, 1608	1	PC
2007-000090	R701	10Kohm, 5%, 1/10W, TP, 1608	1	PC
2007-000090	R702	10Kohm, 5%, 1/10W, TP, 1608	1	PC
2007-000090	R704	10Kohm, 5%, 1/10W, TP, 1608	1	PC
2007-000090	R705	10Kohm, 5%, 1/10W, TP, 1608	1	PC
2007-000090	R801	10Kohm, 5%, 1/10W, TP, 1608	1	PC
2007-000090	R802	10Kohm, 5%, 1/10W, TP, 1608	1	PC
2007-000090	R803	10Kohm, 5%, 1/10W, TP, 1608	1	PC
2007-000090	R804	10Kohm, 5%, 1/10W, TP, 1608	1	PC
2007-000090	R807	10Kohm, 5%, 1/10W, TP, 1608	1	PC
2007-000090	R808	10Kohm, 5%, 1/10W, TP, 1608	1	PC
2007-000090	R810	10Kohm, 5%, 1/10W, TP, 1608	1	PC
2007-000097	R902	47Kohm, 5%, 1/10W, TP, 1608	1	PC
2007-000109	R507	1Mohm, 5%, 1/10W, TP, 1608	1	PC
2007-000116	R501	120ohm, 5%, 1/10W, TP, 1608	1	PC
2007-000239	R506	1.5Kohm, 1%, 1/10W, TP, 1608	1	PC
2007-000385	R115	14.3Kohm, 1%, 1/4W, TP, 3216	1	PC
2007-000481	R101	1Mohm, 5%, 1/4W, TP, 3216	1	PC
2007-000481	R102	1Mohm, 5%, 1/4W, TP, 3216	1	PC
2007-000481	R103	1Mohm, 5%, 1/4W, TP, 3216	1	PC
2007-000781	R106	33ohm, 5%, 1/8W, TP, 2012	1	PC
2007-000924	R112	470Kohm, 1%, 1/4W, TP, 3216	1	PC
2007-000924	R113	470Kohm, 1%, 1/4W, TP, 3216	1	PC
2007-000924	R114	470Kohm, 1%, 1/4W, TP, 3216	1	PC
2007-001068	R401	6.8Kohm, 1%, 1/10W, TP, 1608	1	PC
2007-001068	R402	6.8Kohm, 1%, 1/10W, TP, 1608	1	PC
2007-001074	R107	6.8ohm, 5%, 1/8W, TP, 2012	1	PC
2007-001093	R703	620ohm, 5%, 1/10W, TP, 1608	1	PC
2007-001179	R708	8.2Kohm, 5%, 1/10W, TP, 1608	1	PC
2007-007385	R117	1.2Mohm, 1%, 1/4w, TP, 3216	1	PC
2203-000189	C802	100nF, +80-20%, 25V, Y5V, TP, 1608	1	PC
2203-000189	C803	100nF, +80-20%, 25V, Y5V, TP, 1608	1	PC
2203-000257	C503	10nF, 10%, 50V, X7R, TP, 1608	1	PC
2203-000257	C705	10nF, 10%, 50V, X7R, TP, 1608	1	PC
2203-000257	C801	10nF, 10%, 50V, X7R, TP, 1608	1	PC
2203-000257	C808	10nF, 10%, 50V, X7R, TP, 1608	1	PC
2203-000257	C809	10nF, 10%, 50V, X7R, TP, 1608	1	PC
2203-000440	C901	1nF, 10%, 50V, X7R, TP, 1608	1	PC
2203-005148	C501	100nF, 10%, 16V, X7R, TP, 1608	1	PC
2203-005148	C504	100nF, 10%, 16V, X7R, TP, 1608	1	PC

Electrical Part List

Parts Code	Location	Spec.	Quantity	Unit
2203-005148	C505	100nF, 10%, 16V, X7R, TP, 1608	1	PC
2203-005148	C506	100nF, 10%, 16V, X7R, TP, 1608	1	PC
2203-005148	C507	100nF, 10%, 16V, X7R, TP, 1608	1	PC
2203-005148	C509	100nF, 10%, 16V, X7R, TP, 1608	1	PC
2203-005148	C513	100nF, 10%, 16V, X7R, TP, 1608	1	PC
2203-005249	C104	100nF, 10%, 50V, X7R, TP, 1608	1	PC
2203-005249	C110	100nF, 10%, 50V, X7R, TP, 1608	1	PC
2203-005249	C112	100nF, 10%, 50V, X7R, TP, 1608	1	PC
2203-005249	C113	100nF, 10%, 50V, X7R, TP, 1608	1	PC
2203-005249	C201	100nF, 10%, 50V, X7R, TP, 1608	1	PC
2203-005249	C401	100nF, 10%, 50V, X7R, TP, 1608	1	PC
2203-005249	C402	100nF, 10%, 50V, X7R, TP, 1608	1	PC
2203-005249	C508	100nF, 10%, 50V, X7R, TP, 1608	1	PC
2203-005249	C511	100nF, 10%, 50V, X7R, TP, 1608	1	PC
2203-005249	C514	100nF, 10%, 50V, X7R, TP, 1608	1	PC
2203-005249	C702	100nF, 10%, 50V, X7R, TP, 1608	1	PC
2203-005249	C704	100nF, 10%, 50V, X7R, TP, 1608	1	PC
2203-005249	C707	100nF, 10%, 50V, X7R, TP, 1608	1	PC
2203-005249	C805	100nF, 10%, 50V, X7R, TP, 1608	1	PC
2203-005249	C806	100nF, 10%, 50V, X7R, TP, 1608	1	PC
2203-005249	C807	100nF, 10%, 50V, X7R, TP, 1608	1	PC
2203-006104	C708	1000nF, 10%, 50V, X7R, TP, 3225, 2. 5T	1	PC
2203-006348	C502	1000nF, 10%, 25V, X5R, TP, 1608	1	PC
2203-006348	C510	1000nF, 10%, 25V, X5R, TP, 1608	1	PC
2203-006348	C512	1000nF, 10%, 25V, X5R, TP, 1608	1	PC
2203-006460	C804	2200nF, 10%, 16V, X5R, TP, 1608, -	1	PC
DB41-00975A	PCB	11R RAC INV BLDC, FR-1, 1, T1. 6, 120*120, 2	1	PC
DB91-01114A	IC04	2011' R RAC INV POS Indoor Main Micom	1	PC
DB09-00535A	-	S3F4A1H, 100P, DC5V, 12 MHz, TQFP, 16	1	PC
DB93-11516A	-	LOW COST-PJT, SSEC	1	PC
0402-001227	BD71	D3SBA60, 600V, 2. 3A, SIP-4, BK	1	PC
0501-000294	Q701	KSA708-Y, PNP, 800mW, TO-92, TP, 12	1	PC
1203-000274	IC02	7805, TO-220, 3P, -, PLASTIC, 4. 8/5	1	PC
1203-001238	IC09	78L15, TO-92, 3P, -, PLASTIC, 14. 4/	1	PC
1203-006089	IC01	TOP253PN, DIP, 7P, 6. 35x9. 57mm, PLASTIC, -	1	PC
1404-001274	NTC1	22ohm, 1. 4A, 3100K, 9. 5mW/C, -, 7. 0, -	1	PC
1405-000160	VA71	680V, 4500A, 17. 5x6. 5mm, TP	1	PC
2802-001179	X901	4MHZ, 0. 5%, BK, 8X3X5. 5MM	1	PC
3002-001129	BZ61	85dB, 2KHz, BK	1	PC
3501-001154	RY74	12V, 200mW, 3000mA, 1FormA, 10ms, 10ms	1	PC
3601-001336	F701	250V, 3. 15A, TIME-LAG, CERAMIC, 5. 2x20mm	1	PC
3711-000015	CN21	BOX, 2P, 1R, 2. 5MM, STRAIGHT, SN, WHT	1	PC
3711-000203	CN71	1WALL, 2P/3P, 1R, 7. 92mm, STRAIGHT, SN, WHT	1	PC
3711-000296	CN72	1WALL, 6P, 1R, 3. 96MM, STRAIGHT, SN, WHT	1	PC
3711-000941	CN81	BOX, 4P, 1R, 2. 5mm, STRAIGHT, SN, YEL	1	PC
3711-004182	CN91	BOX, 10P, 1R, 2MM, STRAIGHT, SN, NTR	1	PC
3711-004379	CN43	BOX, 4P, 1R, 2mm, STRAIGHT, SN, WHT	1	PC
3711-004484	CN61	BOX, 5P, 1R, 2mm, STRAIGHT, SN, WHT	1	PC
3711-005716	CN31	BOX, 10P, 1R, 2mm, STRAIGHT, SN, BLK	1	PC
3711-006678	CN32	BOX, 10P, 1R, 2mm, STRAIGHT, SN, BLU	1	PC
6042-000001	C101-1	ID2. 2, OD2. 7, L3. 1, NI+SN, BSP3-1/2H	1	PC
6042-000001	C101-2	ID2. 2, OD2. 7, L3. 1, NI+SN, BSP3-1/2H	1	PC
6042-000002	CN71-1	ID1. 5, OD2, L2. 8, NI+SN, BSP3-1/2H	1	PC
6042-000002	CN71-2	ID1. 5, OD2, L2. 8, NI+SN, BSP3-1/2H	1	PC
6042-000002	F701-1	ID1. 5, OD2, L2. 8, NI+SN, BSP3-1/2H	1	PC
6042-000002	F701-2	ID1. 5, OD2, L2. 8, NI+SN, BSP3-1/2H	1	PC
DB26-00116A	ST11	DB26-00116A, TOP253PN, PL-7, PM-	1	PC
DB27-00017A	FT71	USAV-07153, UU1116, 15. 0mH, +50~-	1	PC
DB67-00942A	VA71_1	VIVALDI-P/J, SHP2, -, -, -, GREEN, SSEC	1	PC
DB93-10917A	CN11	FORTE 1, AWG#28	1	PC

■ OUTDOOR MAIN PCB(09K/12K)

OUTDOOR MAIN PCB(DB93-10938A)

Parts Code	Location	Description	Specification	Q' TY
0401-001099	D020	DIODE-SWITCHING	1N4148WS, 75V, 150mA, SOD-323, TP	1
0401-001099	D021	DIODE-SWITCHING	1N4148WS, 75V, 150mA, SOD-323, TP	1
0401-001099	D030	DIODE-SWITCHING	1N4148WS, 75V, 150mA, SOD-323, TP	1
0401-001099	D040	DIODE-SWITCHING	1N4148WS, 75V, 150mA, SOD-323, TP	1
0401-001099	D501	DIODE-SWITCHING	1N4148WS, 75V, 150mA, SOD-323, TP	1
0401-001099	D503	DIODE-SWITCHING	1N4148WS, 75V, 150mA, SOD-323, TP	1
0401-001099	D551	DIODE-SWITCHING	1N4148WS, 75V, 150mA, SOD-323, TP	1
0401-001099	D552	DIODE-SWITCHING	1N4148WS, 75V, 150mA, SOD-323, TP	1
0402-001192	D154	DIODE-RECTIFIER	ES2D, 200V, 2A, SMB, TP	1
0402-001192	D155	DIODE-RECTIFIER	ES2D, 200V, 2A, SMB, TP	1
0402-001298	BD151	DIODE-BRIDGE	DF06S, 600V, 1A, SMD-4, TP	1
0402-001427	D152	DIODE-RECTIFIER	ES1D, 200V, 1A, DO-214AC, TP	1
0402-001427	D153	DIODE-RECTIFIER	ES1D, 200V, 1A, DO-214AC, TP	1
0402-001429	D151	DIODE-RECTIFIER	US1J, 600V, 1A, DO-214AC, TP	1
0403-001499	ZD051	DIODE-ZENER	MMSZ5252B, 22.8/25.2V, 500mW, SOD-123, TP	1
0403-001499	ZD401	DIODE-ZENER	MMSZ5252B, 22.8/25.2V, 500mW, SOD-123, TP	1
0404-001020	D451	DIODE-SCHOTTKY	BAT54C, 30V, 200mA, SOT-23, TP	1
0404-001020	D452	DIODE-SCHOTTKY	BAT54C, 30V, 200mA, SOT-23, TP	1
0404-001020	D453	DIODE-SCHOTTKY	BAT54C, 30V, 200mA, SOT-23, TP	1
0404-001020	D454	DIODE-SCHOTTKY	BAT54C, 30V, 200mA, SOT-23, TP	1
0404-001020	D491	DIODE-SCHOTTKY	BAT54C, 30V, 200mA, SOT-23, TP	1
0404-001020	D492	DIODE-SCHOTTKY	BAT54C, 30V, 200mA, SOT-23, TP	1
0404-001020	D502	DIODE-SCHOTTKY	BAT54C, 30V, 200mA, SOT-23, TP	1
0404-001020	D553	DIODE-SCHOTTKY	BAT54C, 30V, 200mA, SOT-23, TP	1
0407-000123	D611	DIODE-SWITCHING	DAN202K, 80V, 100mA, SOT-23, TP	1
0501-000534	Q301	TR-SMALL SIGNAL	2SC2412K, NPN, 200mW, SOT-23, TP, 180-390	1
0501-000534	Q651	TR-SMALL SIGNAL	2SC2412K, NPN, 200mW, SOT-23, TP, 180-390	1
0501-000534	Q652	TR-SMALL SIGNAL	2SC2412K, NPN, 200mW, SOT-23, TP, 180-390	1
0506-000175	IC801	TR-ARRAY	2003, NPN, 7, 1W, SOP-16, ST, 1000	1
0601-002423	LED801	LED	SMD, RED, 1.6 X 3.2mm, 639nm, 1.6 X 3.2mm	1
0601-002955	LED803	LED	SMD (REVERSE), YEL, 1.6x1.5mm, 588nm, 3.2x1.6x1.1mm	1
0601-002956	LED802	LED	SMD (REVERSE), GRN, 1.6x1.5mm, 3.2x1.6x1.1mm	1
0604-001148	IC301	PHOTO-COUPLER	TR, 50-600%, 200mW, SMD-4, TP	1
0604-001172	IC152	PHOTO-COUPLER	TR, 150-300, 200mW, SOP, TP	1
1201-002946	IC451	IC-OP AMP	TSSOP, TR, 14P, 5x4.4x1.2mm, 100, 5.5V, -40to+85C, 63dB, 1, 1nA, 1nA, 1.7mV	1
1202-000104	IC251	IC-VOLTAGE COMP.	393, SOP, 8P, 150MIL, DUAL, 36V, CMOS, PLASTIC, 18V, 780mW, 0to+70C, 18V, 5mV, 250nA, 50NA, 30	1
1202-000104	IC611	IC-VOLTAGE COMP.	393, SOP, 8P, 150MIL, DUAL, 36V, CMOS, PLASTIC, 18V, 780mW, 0to+70C, 18V, 5mV, 250nA, 50NA, 30	1
1203-005454	IC153	IC-POSI. FIXED REG.	LD1117S33-HF, SOT-223, 4P, 6.5x3.5mm, PLASTIC, 3.267/3.333, -40to+125C, 0.8, TP	1
2007-000029	R166	R-CHIP	0ohm, 5%, 1/8W, TP, 2012	1
2007-000043	R054	R-CHIP	1Kohm, 1%, 1/10W, TP, 1608	1
2007-000052	R309	R-CHIP	10Kohm, 1%, 1/10W, TP, 1608	1
2007-000066	R155	R-CHIP	20Kohm, 1%, 1/10W, TP, 1608	1
2007-000066	R255	R-CHIP	20Kohm, 1%, 1/10W, TP, 1608	1
2007-000066	R469	R-CHIP	20Kohm, 1%, 1/10W, TP, 1608	1
2007-000066	R472	R-CHIP	20Kohm, 1%, 1/10W, TP, 1608	1

ElectricalPartList

2007-000066	R473	R-CHIP	20Kohm, 1%, 1/10W, TP, 1608	1
2007-000074	R053	R-CHIP	100ohm, 5%, 1/10W, TP, 1608	1
2007-000074	R057	R-CHIP	100ohm, 5%, 1/10W, TP, 1608	1
2007-000074	R401	R-CHIP	100ohm, 5%, 1/10W, TP, 1608	1
2007-000074	R402	R-CHIP	100ohm, 5%, 1/10W, TP, 1608	1
2007-000074	R403	R-CHIP	100ohm, 5%, 1/10W, TP, 1608	1
2007-000074	R404	R-CHIP	100ohm, 5%, 1/10W, TP, 1608	1
2007-000074	R405	R-CHIP	100ohm, 5%, 1/10W, TP, 1608	1
2007-000074	R406	R-CHIP	100ohm, 5%, 1/10W, TP, 1608	1
2007-000074	R507	R-CHIP	100ohm, 5%, 1/10W, TP, 1608	1
2007-000076	R509	R-CHIP	330ohm, 5%, 1/10W, TP, 1608	1
2007-000077	R557	R-CHIP	470ohm, 5%, 1/10W, TP, 1608	1
2007-000077	R558	R-CHIP	470ohm, 5%, 1/10W, TP, 1608	1
2007-000077	R661	R-CHIP	470ohm, 5%, 1/10W, TP, 1608	1
2007-000077	R662	R-CHIP	470ohm, 5%, 1/10W, TP, 1608	1
2007-000078	R310	R-CHIP	1Kohm, 5%, 1/10W, TP, 1608	1
2007-000078	R311	R-CHIP	1Kohm, 5%, 1/10W, TP, 1608	1
2007-000078	R501	R-CHIP	1Kohm, 5%, 1/10W, TP, 1608	1
2007-000078	R510	R-CHIP	1Kohm, 5%, 1/10W, TP, 1608	1
2007-000078	R511	R-CHIP	1Kohm, 5%, 1/10W, TP, 1608	1
2007-000078	R512	R-CHIP	1Kohm, 5%, 1/10W, TP, 1608	1
2007-000078	R514	R-CHIP	1Kohm, 5%, 1/10W, TP, 1608	1
2007-000078	R517	R-CHIP	1Kohm, 5%, 1/10W, TP, 1608	1
2007-000078	R651	R-CHIP	1Kohm, 5%, 1/10W, TP, 1608	1
2007-000080	R256	R-CHIP	2Kohm, 5%, 1/10W, TP, 1608	1
2007-000080	R257	R-CHIP	2Kohm, 5%, 1/10W, TP, 1608	1
2007-000080	R409	R-CHIP	2Kohm, 5%, 1/10W, TP, 1608	1
2007-000080	R504	R-CHIP	2Kohm, 5%, 1/10W, TP, 1608	1
2007-000080	R621	R-CHIP	2Kohm, 5%, 1/10W, TP, 1608	1
2007-000082	R052	R-CHIP	3.3Kohm, 5%, 1/10W, TP, 1608	1
2007-000084	R408	R-CHIP	4.7Kohm, 5%, 1/10W, TP, 1608	1
2007-000084	R551	R-CHIP	4.7Kohm, 5%, 1/10W, TP, 1608	1
2007-000084	R552	R-CHIP	4.7Kohm, 5%, 1/10W, TP, 1608	1
2007-000084	R553	R-CHIP	4.7Kohm, 5%, 1/10W, TP, 1608	1
2007-000084	R554	R-CHIP	4.7Kohm, 5%, 1/10W, TP, 1608	1
2007-000084	R555	R-CHIP	4.7Kohm, 5%, 1/10W, TP, 1608	1
2007-000084	R556	R-CHIP	4.7Kohm, 5%, 1/10W, TP, 1608	1
2007-000090	R502	R-CHIP	10Kohm, 5%, 1/10W, TP, 1608	1
2007-000090	R515	R-CHIP	10Kohm, 5%, 1/10W, TP, 1608	1
2007-000090	R516	R-CHIP	10Kohm, 5%, 1/10W, TP, 1608	1
2007-000090	R559	R-CHIP	10Kohm, 5%, 1/10W, TP, 1608	1
2007-000090	R560	R-CHIP	10Kohm, 5%, 1/10W, TP, 1608	1
2007-000090	R561	R-CHIP	10Kohm, 5%, 1/10W, TP, 1608	1
2007-000090	R663	R-CHIP	10Kohm, 5%, 1/10W, TP, 1608	1
2007-000090	R664	R-CHIP	10Kohm, 5%, 1/10W, TP, 1608	1
2007-000093	R508	R-CHIP	20Kohm, 5%, 1/10W, TP, 1608	1
2007-000106	R506	R-CHIP	220Kohm, 5%, 1/10W, TP, 1608	1
2007-000109	R503	R-CHIP	1Mohm, 5%, 1/10W, TP, 1608	1
2007-000120	R313	R-CHIP	680ohm, 5%, 1/10W, TP, 1608	1
2007-000227	R167	R-CHIP	1.2Mohm, 5%, 1/4W, TP, 3216	1

ElectricalPartList

2007-000238	R312	R-CHIP	1.5Kohm, 1%, 1/8W, TP, 2012	1
2007-000238	R314	R-CHIP	1.5Kohm, 1%, 1/8W, TP, 2012	1
2007-000263	R614	R-CHIP	1.82Kohm, 1%, 1/8W, TP, 2012	1
2007-000263	R616	R-CHIP	1.82Kohm, 1%, 1/8W, TP, 2012	1
2007-000468	R801	R-CHIP	1Kohm, 5%, 1/8W, TP, 2012	1
2007-000468	R802	R-CHIP	1Kohm, 5%, 1/8W, TP, 2012	1
2007-000468	R803	R-CHIP	1Kohm, 5%, 1/8W, TP, 2012	1
2007-000481	R163	R-CHIP	1Mohm, 5%, 1/4W, TP, 3216	1
2007-000481	R164	R-CHIP	1Mohm, 5%, 1/4W, TP, 3216	1
2007-000481	R165	R-CHIP	1Mohm, 5%, 1/4W, TP, 3216	1
2007-000614	R470	R-CHIP	24Kohm, 1%, 1/10W, TP, 1608	1
2007-000614	R471	R-CHIP	24Kohm, 1%, 1/10W, TP, 1608	1
2007-000614	R474	R-CHIP	24Kohm, 1%, 1/10W, TP, 1608	1
2007-000614	R475	R-CHIP	24Kohm, 1%, 1/10W, TP, 1608	1
2007-000614	R478	R-CHIP	24Kohm, 1%, 1/10W, TP, 1608	1
2007-000669	R254	R-CHIP	2Kohm, 1%, 1/10W, TP, 1608	1
2007-000669	R476	R-CHIP	2Kohm, 1%, 1/10W, TP, 1608	1
2007-000669	R477	R-CHIP	2Kohm, 1%, 1/10W, TP, 1608	1
2007-000683	R454	R-CHIP	3.3Kohm, 1%, 1/10W, TP, 1608	1
2007-000683	R459	R-CHIP	3.3Kohm, 1%, 1/10W, TP, 1608	1
2007-000683	R466	R-CHIP	3.3Kohm, 1%, 1/10W, TP, 1608	1
2007-000708	R253	R-CHIP	3.9Kohm, 1%, 1/10W, TP, 1608	1
2007-000869	R252	R-CHIP	4.7Kohm, 1%, 1/10W, TP, 1608	1
2007-000924	R106	R-CHIP	470Kohm, 1%, 1/4W, TP, 3216	1
2007-000924	R107	R-CHIP	470Kohm, 1%, 1/4W, TP, 3216	1
2007-000924	R108	R-CHIP	470Kohm, 1%, 1/4W, TP, 3216	1
2007-000924	R658	R-CHIP	470Kohm, 1%, 1/4W, TP, 3216	1
2007-000924	R659	R-CHIP	470Kohm, 1%, 1/4W, TP, 3216	1
2007-000924	R660	R-CHIP	470Kohm, 1%, 1/4W, TP, 3216	1
2007-000929	R153	R-CHIP	470ohm, 1%, 1/10W, TP, 1608	1
2007-000929	R154	R-CHIP	470ohm, 1%, 1/10W, TP, 1608	1
2007-000934	R158	R-CHIP	470ohm, 5%, 1/4W, TP, 3216	1
2007-000934	R159	R-CHIP	470ohm, 5%, 1/4W, TP, 3216	1
2007-000939	R652	R-CHIP	47Kohm, 1%, 1/10W, TP, 1608	1
2007-000944	R301	R-CHIP	47Kohm, 5%, 1/4W, TP, 3216	1
2007-000944	R302	R-CHIP	47Kohm, 5%, 1/4W, TP, 3216	1
2007-000944	R303	R-CHIP	47Kohm, 5%, 1/4W, TP, 3216	1
2007-000944	R304	R-CHIP	47Kohm, 5%, 1/4W, TP, 3216	1
2007-000944	R305	R-CHIP	47Kohm, 5%, 1/4W, TP, 3216	1
2007-000944	R306	R-CHIP	47Kohm, 5%, 1/4W, TP, 3216	1
2007-000944	R307	R-CHIP	47Kohm, 5%, 1/4W, TP, 3216	1
2007-000944	R308	R-CHIP	47Kohm, 5%, 1/4W, TP, 3216	1
2007-000962	R055	R-CHIP	5.1Kohm, 1%, 1/10W, TP, 1608	1
2007-000962	R654	R-CHIP	5.1Kohm, 1%, 1/10W, TP, 1608	1
2007-001068	R491	R-CHIP	6.8Kohm, 1%, 1/10W, TP, 1608	1
2007-001074	R152	R-CHIP	6.8ohm, 5%, 1/8W, TP, 2012	1
2007-001174	R104	R-CHIP	8.25Kohm, 1%, 1/4W, TP, 3216	1
2007-001174	R657	R-CHIP	8.25Kohm, 1%, 1/4W, TP, 3216	1
2007-001175	R056	R-CHIP	8.2Kohm, 1%, 1/10W, TP, 1608	1
2007-001175	R410	R-CHIP	8.2Kohm, 1%, 1/10W, TP, 1608	1
2007-001175	R655	R-CHIP	8.2Kohm, 1%, 1/10W, TP, 1608	1

2007-002637	R611	R-CHIP	60.4Kohm, 1%, 1/4W, TP, 3216	1
2007-002637	R612	R-CHIP	60.4Kohm, 1%, 1/4W, TP, 3216	1
2007-002637	R613	R-CHIP	60.4Kohm, 1%, 1/4W, TP, 3216	1
2007-002637	R615	R-CHIP	60.4Kohm, 1%, 1/4W, TP, 3216	1
2007-002637	R617	R-CHIP	60.4Kohm, 1%, 1/4W, TP, 3216	1
2007-002637	R618	R-CHIP	60.4Kohm, 1%, 1/4W, TP, 3216	1
2007-007225	R455	R-CHIP	1.62Kohm, 1%, 1/10W, TP, 1608	1
2007-007225	R457	R-CHIP	1.62Kohm, 1%, 1/10W, TP, 1608	1
2007-007225	R468	R-CHIP	1.62Kohm, 1%, 1/10W, TP, 1608	1
2007-007225	R492	R-CHIP	1.62Kohm, 1%, 1/10W, TP, 1608	1
2007-007342	R157	R-CHIP	1.82Kohm, 1%, 1/10W, TP, 1608	1
2007-007445	R156	R-CHIP	9.09Kohm, 1%, 1/10W, TP, 1608	1
2007-007768	R251	R-CHIP	13Kohm, 1%, 1/10W, TP, 1608	1
2007-007768	R259	R-CHIP	13Kohm, 1%, 1/10W, TP, 1608	1
2007-007818	R260	R-CHIP	360Kohm, 1%, 1/10W, TP, 1608	1
2007-008003	R513	R-CHIP	4.7Mohm, 1%, 1/10W, TP, 1608	1
2007-008023	R101	R-CHIP	100Kohm, 5%, 1W, TP, 6432	1
2007-008023	R102	R-CHIP	100Kohm, 5%, 1W, TP, 6432	1
2007-008023	R103	R-CHIP	100Kohm, 5%, 1W, TP, 6432	1
2007-010245	R062	R-CHIP	0.01ohm, 1%, 2W, TP, 6432	1
2007-010245	R063	R-CHIP	0.01ohm, 1%, 2W, TP, 6432	1
2007-010245	R451	R-CHIP	0.01ohm, 1%, 2W, TP, 6432	1
2007-010245	R452	R-CHIP	0.01ohm, 1%, 2W, TP, 6432	1
2007-010245	R453	R-CHIP	0.01ohm, 1%, 2W, TP, 6432	1
2203-000236	C054	C-CER, CHIP	0.1nF, 5%, 50V, COG, TP, 1608	1
2203-000257	C053	C-CER, CHIP	10nF, 10%, 50V, X7R, TP, 1608	1
2203-000257	C057	C-CER, CHIP	10nF, 10%, 50V, X7R, TP, 1608	1
2203-000257	C302	C-CER, CHIP	10nF, 10%, 50V, X7R, TP, 1608	1
2203-000257	C303	C-CER, CHIP	10nF, 10%, 50V, X7R, TP, 1608	1
2203-000257	C517	C-CER, CHIP	10nF, 10%, 50V, X7R, TP, 1608	1
2203-000257	C518	C-CER, CHIP	10nF, 10%, 50V, X7R, TP, 1608	1
2203-000257	C611	C-CER, CHIP	10nF, 10%, 50V, X7R, TP, 1608	1
2203-000257	C612	C-CER, CHIP	10nF, 10%, 50V, X7R, TP, 1608	1
2203-000257	C613	C-CER, CHIP	10nF, 10%, 50V, X7R, TP, 1608	1
2203-000257	C651	C-CER, CHIP	10nF, 10%, 50V, X7R, TP, 1608	1
2203-000440	C404	C-CER, CHIP	1nF, 10%, 50V, X7R, TP, 1608	1
2203-000440	C406	C-CER, CHIP	1nF, 10%, 50V, X7R, TP, 1608	1
2203-000440	C407	C-CER, CHIP	1nF, 10%, 50V, X7R, TP, 1608	1
2203-000440	C409	C-CER, CHIP	1nF, 10%, 50V, X7R, TP, 1608	1
2203-000440	C410	C-CER, CHIP	1nF, 10%, 50V, X7R, TP, 1608	1
2203-000440	C411	C-CER, CHIP	1nF, 10%, 50V, X7R, TP, 1608	1
2203-000440	C414	C-CER, CHIP	1nF, 10%, 50V, X7R, TP, 1608	1
2203-000440	C501	C-CER, CHIP	1nF, 10%, 50V, X7R, TP, 1608	1
2203-000440	C514	C-CER, CHIP	1nF, 10%, 50V, X7R, TP, 1608	1
2203-000440	C515	C-CER, CHIP	1nF, 10%, 50V, X7R, TP, 1608	1
2203-000440	C516	C-CER, CHIP	1nF, 10%, 50V, X7R, TP, 1608	1
2203-000783	C455	C-CER, CHIP	0.33nF, 5%, 50V, COG, 1608	1
2203-000783	C458	C-CER, CHIP	0.33nF, 5%, 50V, COG, 1608	1
2203-002002	C453	C-CER, CHIP	0.033nF, 5%, 50V, NPO, TP, 1608	1
2203-002002	C454	C-CER, CHIP	0.033nF, 5%, 50V, NPO, TP, 1608	1

2203-002002	C459	C-CER, CHIP	0.033nF, 5%, 50V, NP0, TP, 1608	1
2203-005249	C051	C-CER, CHIP	100nF, 10%, 50V, X7R, TP, 1608	1
2203-005249	C052	C-CER, CHIP	100nF, 10%, 50V, X7R, TP, 1608	1
2203-005249	C156	C-CER, CHIP	100nF, 10%, 50V, X7R, TP, 1608	1
2203-005249	C157	C-CER, CHIP	100nF, 10%, 50V, X7R, TP, 1608	1
2203-005249	C158	C-CER, CHIP	100nF, 10%, 50V, X7R, TP, 1608	1
2203-005249	C159	C-CER, CHIP	100nF, 10%, 50V, X7R, TP, 1608	1
2203-005249	C163	C-CER, CHIP	100nF, 10%, 50V, X7R, TP, 1608	1
2203-005249	C251	C-CER, CHIP	100nF, 10%, 50V, X7R, TP, 1608	1
2203-005249	C252	C-CER, CHIP	100nF, 10%, 50V, X7R, TP, 1608	1
2203-005249	C401	C-CER, CHIP	100nF, 10%, 50V, X7R, TP, 1608	1
2203-005249	C402	C-CER, CHIP	100nF, 10%, 50V, X7R, TP, 1608	1
2203-005249	C403	C-CER, CHIP	100nF, 10%, 50V, X7R, TP, 1608	1
2203-005249	C408	C-CER, CHIP	100nF, 10%, 50V, X7R, TP, 1608	1
2203-005249	C460	C-CER, CHIP	100nF, 10%, 50V, X7R, TP, 1608	1
2203-005249	C506	C-CER, CHIP	100nF, 10%, 50V, X7R, TP, 1608	1
2203-005249	C507	C-CER, CHIP	100nF, 10%, 50V, X7R, TP, 1608	1
2203-005249	C508	C-CER, CHIP	100nF, 10%, 50V, X7R, TP, 1608	1
2203-005249	C509	C-CER, CHIP	100nF, 10%, 50V, X7R, TP, 1608	1
2203-005249	C510	C-CER, CHIP	100nF, 10%, 50V, X7R, TP, 1608	1
2203-005249	C511	C-CER, CHIP	100nF, 10%, 50V, X7R, TP, 1608	1
2203-005249	C512	C-CER, CHIP	100nF, 10%, 50V, X7R, TP, 1608	1
2203-005249	C519	C-CER, CHIP	100nF, 10%, 50V, X7R, TP, 1608	1
2203-005249	C520	C-CER, CHIP	100nF, 10%, 50V, X7R, TP, 1608	1
2203-005249	C521	C-CER, CHIP	100nF, 10%, 50V, X7R, TP, 1608	1
2203-005249	C614	C-CER, CHIP	100nF, 10%, 50V, X7R, TP, 1608	1
2203-005249	C801	C-CER, CHIP	100nF, 10%, 50V, X7R, TP, 1608	1
2203-006104	C301	C-CER, CHIP	1000nF, 10%, 50V, X7R, TP, 3225, 2.5T	1
2203-006348	C253	C-CER, CHIP	1000nF, 10%, 25V, X5R, TP, 1608	1
2203-006348	C502	C-CER, CHIP	1000nF, 10%, 25V, X5R, TP, 1608	1
2203-006348	C503	C-CER, CHIP	1000nF, 10%, 25V, X5R, TP, 1608	1
2203-006348	C504	C-CER, CHIP	1000nF, 10%, 25V, X5R, TP, 1608	1
2203-006348	C505	C-CER, CHIP	1000nF, 10%, 25V, X5R, TP, 1608	1
2203-006348	C523	C-CER, CHIP	1000nF, 10%, 25V, X5R, TP, 1608	1
2402-001183	CE451	C-AL, SMD	22uF, 20%, 16V, WT, TP, 5.3X5.3X6MM	1
2402-001268	CE051	C-AL, SMD	100uF, 20%, 25V, WT, TP, 8x6.3mm	1
2402-001268	CE405	C-AL, SMD	100uF, 20%, 25V, WT, TP, 8x6.3mm	1
2402-001368	CE402	C-AL, SMD	47uF, 20%, 25V, TP, 6.3x4.9mm	1
2402-001368	CE403	C-AL, SMD	47uF, 20%, 25V, TP, 6.3x4.9mm	1
2402-001368	CE404	C-AL, SMD	47uF, 20%, 25V, TP, 6.3x4.9mm	1
2703-003657	L151	INDUCTOR-SMD	3.3uH, 20%, 3030	1
2802-001211	X501	RESONATOR-CERAMIC	8MHZ, 0.1%, TP, 3.2X1.3X0.9 MM	1
DB41-01011A	PCB	PCB MAIN-OUT	MALDIVES-PJT, FR-4, 2, T1.6, 142*175mm, 1, OUT, OI-INVERTER, 600V OVER	1
DB91-01172A	IC501	ASSY-MIC	MALDIVES OUTDOOR INV MICOM, STM-1037-OA, LM3S817, 48LQFP, ROM 64KB	1
DB09-00591A	-	IC MICOM	LM3S817, 48, DC3V, 50 MHz, LQFP, LQFP, LQFP, -40 ~ 85, 64KB, LQFP	1
2003-000855	R151	R-METAL OXIDE(S)	47Kohm, 5%, 3W, AA, TP, 6x16mm	1
2201-000153	C004	C-CERAMIC, DISC	10nF, +80-20%, 250V, Y5V, -, 14.6x6mm, 7.5	1
2201-000153	C005	C-CERAMIC, DISC	10nF, +80-20%, 250V, Y5V, -, 14.6x6mm, 7.5	1
2201-000322	C151	C-CERAMIC, DISC	2.2nF, 10%, 2000V, Y5P, 13x5mm, 10mm	1
2201-000322	C152	C-CERAMIC, DISC	2.2nF, 10%, 2000V, Y5P, 13x5mm, 10mm	1

2201-000446	C002	C-CERAMIC, DISC	3. 3nF, 20%, 400V, Y5U, TP, 15x6mm, 10mm	1
2201-000446	C003	C-CERAMIC, DISC	3. 3nF, 20%, 400V, Y5U, TP, 15x6mm, 10mm	1
2201-002128	C061	C-CERAMIC, DISC	4. 7nF, 20%, 400V, Y5U, BK, 15x7mm, 10mm	1
2301-001285	C001	C-FILM, LEAD-PPF	680nF, 10%, 275V, BK, 31x11x21mm	1
2301-001285	C006	C-FILM, LEAD-PPF	680nF, 10%, 275V, BK, 31x11x21mm	1
2301-001992	CR041	C-FILM, LEAD	1500nF, +10-5%, 450V, BK, 36x16x26. 5mm	1
2306-000123	C060	C-FILM, LEAD-PPF	100nF, 5%, 630V, BK, 26x16. 5x8. 5mm	1
2306-000123	C400	C-FILM, LEAD-PPF	100nF, 5%, 630V, BK, 26x16. 5x8. 5mm	1
2401-000481	CE152	C-AL	10uF, 20%, 50V, WT, TP, 5x11, 5	1
2401-001281	CE301	C-AL	4. 7uF, 20%, 50V, WT, TP, 5x11, 5	1
2401-001548	CE159	C-AL	47uF, 20%, 25V, WT, TP, 5x11, 5	1
2401-001838	CE154	C-AL	470uF, 20%, 25V, WT, TP, 10x16, 5	1
2401-001838	CE157	C-AL	470uF, 20%, 25V, WT, TP, 10x16, 5	1
2401-003139	CE155	C-AL	1000uF, 20%, 25V, WT, TP, 10*20, 5mm	1
2401-003224	CE153	C-AL	470uF, 20%, 16V, WT, TP, 8X11. 5, 5mm	1
2401-003224	CE156	C-AL	470uF, 20%, 16V, WT, TP, 8X11. 5, 5mm	1
2401-003645	CE158	C-AL	1UF, 20%, 50V, WT, TP, 4X5MM, 5	1
2401-004267	CE151	C-AL	22uF, 20%, 500V, TP, 16*25, 7. 5mm	1
2401-004874	CE101	C-AL	330uF, 20%, 400V, BK, 25. 4*50, 10mm	1
2401-004874	CE102	C-AL	330uF, 20%, 400V, BK, 25. 4*50, 10mm	1
2401-004874	CE103	C-AL	330uF, 20%, 400V, BK, 25. 4*50, 10mm	1
3601-001538	F001	FUSE-AXIAL LEAD	250V, 15A, TIME-LAG, CERAMIC, 6. 35x31. 8mm	1
4715-001093	DSA001	SURGE ABSORBER	3600V, 20%, 2000A, -, AXIAL	1
1203-000002	IC157	IC-POSI. ADJUST REG.	431, TO-92, 3P, -, PLASTIC, 2. 44/2. 58V, 775MV, 0TO+70C, 100MA, -, ST, -	1
1203-006089	IC151	IC-PWM CONTROLLER	TOP253PN, DIP, 7P, 6. 35x9. 57mm, PLASTIC, -0. 3V/700V, 15W, -40Cto+150C, 1. 37A, ST	1
1404-001274	NTC151	THERMISTOR-NTC	22ohm, 1. 4A, 3100K, 9. 5mW/C, -, 7. 0, -	1
1404-001498	PTC020	THERMISTOR-PTC	40ohm, 25%, 290Vac, 7A, TR	1
1405-000154	VA003	VARIATOR	460Vdc, 2500A, 17. 5x7. 5mm, TP	1
1405-000154	VA004	VARIATOR	460Vdc, 2500A, 17. 5x7. 5mm, TP	1
1405-000160	VA002	VARIATOR	680V, 4500A, 17. 5x6. 5mm, TP	1
1405-000160	VA151	VARIATOR	680V, 4500A, 17. 5x6. 5mm, TP	1
3501-000273	RY021	RELAY-POWER	12V, 540mW, 16000mA, 1FormA, 20ms, 6ms	1
3501-001264	RY022	RELAY-POWER	12V, 200mW, 5000mA, 1FormA, 10ms, 10ms	1
3501-001264	RY040	RELAY-POWER	12V, 200mW, 5000mA, 1FormA, 10ms, 10ms	1
3501-001264	RY041	RELAY-POWER	12V, 200mW, 5000mA, 1FormA, 10ms, 10ms	1
3704-001601	IC502	SOCKET-IC	8P, SN, 2. 54mm	1
3711-000015	CN251	HEADER-BOARD TO CABLE	BOX, 2P, 1R, 2. 5MM, STRAIGHT, SN, WHT	1
3711-000203	CN030	HEADER-BOARD TO CABLE	1WALL, 2P/3P, 1R, 7. 92mm, STRAIGHT, SN, WHT	1
3711-003381	CN040	CONNECTOR-HEADER	1WALL, 5P, 1R, 3. 96mm, ANGLE, SN, WHT	1
3711-007656	CN451	HEADER-BOARD TO CABLE	BOX, 3, 1R, 6mm, STRAIGHT, WHT	1
3711-007659	CN051	HEADER-BOARD TO CABLE	2, 1R, 7. 92mm, STRAIGHT, WHT	1
3711-007717	CN551	HEADER-BOARD TO CABLE	BOX, 10P, 1R, 2mm, ANGLE, SN, RED	1
3712-001139	CN001	CONNECTOR-TERMINAL	TAB, MALE, 6. 35x0. 8mm	1
3712-001139	CN002	CONNECTOR-TERMINAL	TAB, MALE, 6. 35x0. 8mm	1
3712-001139	CN003	CONNECTOR-TERMINAL	TAB, MALE, 6. 35x0. 8mm	1
3712-001139	CN301	CONNECTOR-TERMINAL	TAB, MALE, 6. 35x0. 8mm	1
4719-002483	PFC050	POWER MODULE	Smart Power Module, FPAB20BH60B, 600V, 20A, 89W, 20kHz, PFCM	1
4719-002484	IPM400	POWER MODULE	Smart Power Module, FNA41560B2, 600V, 15A, 41W, 20kHz	1
DB26-00119A	PT151	TRANS SWITCHING	EE2218, TOP253PN(OI-INV), 220V, EE22, NC-2H, 15V, 12V, 6V, EE2218, 50/60Hz, 1618, 15V, 12V, 6V, OI-INVERTER	1
DB27-00076A	FT001	COIL FILTER	MALDIVE, 12mH, 22m, 10A	1

DB61-04692A	IPM_SUPPORT	SUPPORT-PBA	SI Inv(MALDIVES1 12k), PA66-FR(40), 1.5, 109, 26.8, 4.5, 5V, 4.5g, BLACK	1
DB67-00942A	VA002	CAP	VIVALDI-P/J, SHP2, -, -, GREEN, SSEC	1
DB67-00942A	VA003	CAP	VIVALDI-P/J, SHP2, -, -, GREEN, SSEC	1
DB67-00942A	VA004	CAP	VIVALDI-P/J, SHP2, -, -, GREEN, SSEC	1
DB67-00942A	VA151	CAP	VIVALDI-P/J, SHP2, -, -, GREEN, SSEC	1

OUTDOOR MAIN PCB (DB93-10952A)

Parts Code	Design location	Spec.	Quantity	Unit	Service
DB93-11578A	-	SI-PJT, SSEC	1	PC	SNA
0401-001099	D020	1N4148WS, 75V, 150mA, SOD-323, TP	1	PC	SNA
0401-001099	D021	1N4148WS, 75V, 150mA, SOD-323, TP	1	PC	SNA
0401-001099	D030	1N4148WS, 75V, 150mA, SOD-323, TP	1	PC	SNA
0401-001099	D501	1N4148WS, 75V, 150mA, SOD-323, TP	1	PC	SNA
0401-001099	D503	1N4148WS, 75V, 150mA, SOD-323, TP	1	PC	SNA
0401-001099	D510	1N4148WS, 75V, 150mA, SOD-323, TP	1	PC	SNA
0401-001099	D511	1N4148WS, 75V, 150mA, SOD-323, TP	1	PC	SNA
0401-001099	D512	1N4148WS, 75V, 150mA, SOD-323, TP	1	PC	SNA
0401-001099	D514	1N4148WS, 75V, 150mA, SOD-323, TP	1	PC	SNA
0401-001099	D551	1N4148WS, 75V, 150mA, SOD-323, TP	1	PC	SNA
0401-001099	D552	1N4148WS, 75V, 150mA, SOD-323, TP	1	PC	SNA
0402-001097	D156	B140, 40V, 1000mA, DO-214AC, TP	1	PC	SNA
0402-001192	D153	ES2D, 200V, 2A, SMB, TP	1	PC	SNA
0402-001192	D154	ES2D, 200V, 2A, SMB, TP	1	PC	SNA
0402-001192	D155	ES2D, 200V, 2A, SMB, TP	1	PC	SNA
0402-001298	BD151	DF06S, 600V, 1A, SMD-4, TP	1	PC	SNA
0402-001427	D152	ES1D, 200V, 1A, DO-214AC, TP	1	PC	SNA
0402-001429	D151	US1J, 600V, 1A, DO-214AC, TP	1	PC	SNA
0403-001499	ZD051	MMSZ5252B, 22. 8/25. 2V, 500mW, SOD-123, TP	1	PC	SNA
0403-001499	ZD401	MMSZ5252B, 22. 8/25. 2V, 500mW, SOD-123, TP	1	PC	SNA
0404-001020	D109	BAT54C, 30V, 200mA, SOT-23, TP	1	PC	SNA
0404-001020	D451	BAT54C, 30V, 200mA, SOT-23, TP	1	PC	SNA
0404-001020	D452	BAT54C, 30V, 200mA, SOT-23, TP	1	PC	SNA
0404-001020	D453	BAT54C, 30V, 200mA, SOT-23, TP	1	PC	SNA
0404-001020	D454	BAT54C, 30V, 200mA, SOT-23, TP	1	PC	SNA
0404-001020	D491	BAT54C, 30V, 200mA, SOT-23, TP	1	PC	SNA
0404-001020	D492	BAT54C, 30V, 200mA, SOT-23, TP	1	PC	SNA
0404-001020	D502	BAT54C, 30V, 200mA, SOT-23, TP	1	PC	SNA
0406-001204	CD301	SMBJ5.0CA, 6. 4/-/7. 25V, 600W, SMB	1	PC	SNA
0406-001204	CD302	SMBJ5.0CA, 6. 4/-/7. 25V, 600W, SMB	1	PC	SNA
0406-001204	CD303	SMBJ5.0CA, 6. 4/-/7. 25V, 600W, SMB	1	PC	SNA
0407-000123	D611	DAN202K, 80V, 100mA, SOT-23, TP	1	PC	SNA
0501-000463	Q651	KST2907A, PNP, 350mW, SOT-23, TP, 100-300	1	PC	SNA
0501-000463	Q652	KST2907A, PNP, 350mW, SOT-23, TP, 100-300	1	PC	SNA
0504-000127	Q902	FJV3102R, NPN, 200mW, 10K/10Kohm, SOT-	1	PC	SNA
0506-000175	IC701	2003, NPN, 7, 1W, SOP-16, ST, 1000	1	PC	SNA
0506-000175	IC801	2003, NPN, 7, 1W, SOP-16, ST, 1000	1	PC	SNA
0601-002423	LED801	SMD, RED, 1. 6 X 3. 2mm, 639nm, 1. 6 X 3. 2mm	1	PC	SNA
0601-002955	LED803	SMD (REVERSE), YEL, 1. 6x1. 5mm, 588nm, 3. 2x1	1	PC	SNA
0601-002956	LED501	SMD (REVERSE), GRN, 1. 6x1. 5mm, 3. 2x1. 6x1. 1	1	PC	SNA
0601-002956	LED802	SMD (REVERSE), GRN, 1. 6x1. 5mm, 3. 2x1. 6x1. 1	1	PC	SNA
0604-001172	IC152	TR, 150-300, 200mW, SOP, TP	1	PC	SNA
0604-001172	IC155	TR, 150-300, 200mW, SOP, TP	1	PC	SNA
0604-001172	IC351	TR, 150-300, 200mW, SOP, TP	1	PC	SNA
0604-001172	IC352	TR, 150-300, 200mW, SOP, TP	1	PC	SNA
0604-001172	IC505	TR, 150-300, 200mW, SOP, TP	1	PC	SNA
0801-000393	IC302	74HC86, OR	1	PC	SNA
1006-001325	IC301	ISL81487LIBZ, SO, 8P, 4. 9x3. 8	1	PC	SNA
1201-002946	IC451	TSSOP, TR, 14P, 5x4. 4x1. 2mm, 100, 5. 5V, -	1	PC	SNA

Electrical Part List

Parts Code	Design location	Spec.	Quantity	Unit	Service
1202-000104	IC611	393, SOP, 8P, 150MIL, DUAL, 36V, CMOS, PLASTI	1	PC	SNA
1203-005797	IC154	SI-8008TMX-TL, T0263-	1	PC	SNA
2007-000029	R166	0ohm, 5%, 1/8W, TP, 2012	1	PC	SNA
2007-000043	R054	1Kohm, 1%, 1/10W, TP, 1608	1	PC	SNA
2007-000052	R156	10Kohm, 1%, 1/10W, TP, 1608	1	PC	SNA
2007-000052	R157	10Kohm, 1%, 1/10W, TP, 1608	1	PC	SNA
2007-000066	R155	20Kohm, 1%, 1/10W, TP, 1608	1	PC	SNA
2007-000066	R653	20Kohm, 1%, 1/10W, TP, 1608	1	PC	SNA
2007-000070	R309	0ohm, 5%, 1/10W, TP, 1608	1	PC	SNA
2007-000074	R053	100ohm, 5%, 1/10W, TP, 1608	1	PC	SNA
2007-000074	R057	100ohm, 5%, 1/10W, TP, 1608	1	PC	SNA
2007-000074	R401	100ohm, 5%, 1/10W, TP, 1608	1	PC	SNA
2007-000074	R402	100ohm, 5%, 1/10W, TP, 1608	1	PC	SNA
2007-000074	R403	100ohm, 5%, 1/10W, TP, 1608	1	PC	SNA
2007-000074	R404	100ohm, 5%, 1/10W, TP, 1608	1	PC	SNA
2007-000074	R405	100ohm, 5%, 1/10W, TP, 1608	1	PC	SNA
2007-000074	R406	100ohm, 5%, 1/10W, TP, 1608	1	PC	SNA
2007-000074	R507	100ohm, 5%, 1/10W, TP, 1608	1	PC	SNA
2007-000076	R254	330ohm, 5%, 1/10W, TP, 1608	1	PC	SNA
2007-000076	R255	330ohm, 5%, 1/10W, TP, 1608	1	PC	SNA
2007-000076	R256	330ohm, 5%, 1/10W, TP, 1608	1	PC	SNA
2007-000076	R259	330ohm, 5%, 1/10W, TP, 1608	1	PC	SNA
2007-000076	R352	330ohm, 5%, 1/10W, TP, 1608	1	PC	SNA
2007-000076	R353	330ohm, 5%, 1/10W, TP, 1608	1	PC	SNA
2007-000076	R509	330ohm, 5%, 1/10W, TP, 1608	1	PC	SNA
2007-000076	R521	330ohm, 5%, 1/10W, TP, 1608	1	PC	SNA
2007-000077	R158	470ohm, 5%, 1/10W, TP, 1608	1	PC	SNA
2007-000077	R557	470ohm, 5%, 1/10W, TP, 1608	1	PC	SNA
2007-000077	R558	470ohm, 5%, 1/10W, TP, 1608	1	PC	SNA
2007-000078	R206	1Kohm, 5%, 1/10W, TP, 1608	1	PC	SNA
2007-000078	R303	1Kohm, 5%, 1/10W, TP, 1608	1	PC	SNA
2007-000078	R307	1Kohm, 5%, 1/10W, TP, 1608	1	PC	SNA
2007-000078	R308	1Kohm, 5%, 1/10W, TP, 1608	1	PC	SNA
2007-000078	R351	1Kohm, 5%, 1/10W, TP, 1608	1	PC	SNA
2007-000078	R354	1Kohm, 5%, 1/10W, TP, 1608	1	PC	SNA
2007-000078	R501	1Kohm, 5%, 1/10W, TP, 1608	1	PC	SNA
2007-000078	R505	1Kohm, 5%, 1/10W, TP, 1608	1	PC	SNA
2007-000078	R510	1Kohm, 5%, 1/10W, TP, 1608	1	PC	SNA
2007-000078	R511	1Kohm, 5%, 1/10W, TP, 1608	1	PC	SNA
2007-000078	R512	1Kohm, 5%, 1/10W, TP, 1608	1	PC	SNA
2007-000078	R515	1Kohm, 5%, 1/10W, TP, 1608	1	PC	SNA
2007-000080	R409	2Kohm, 5%, 1/10W, TP, 1608	1	PC	SNA
2007-000080	R504	2Kohm, 5%, 1/10W, TP, 1608	1	PC	SNA
2007-000080	R621	2Kohm, 5%, 1/10W, TP, 1608	1	PC	SNA
2007-000082	R052	3. 3Kohm, 5%, 1/10W, TP, 1608	1	PC	SNA
2007-000084	R408	4. 7Kohm, 5%, 1/10W, TP, 1608	1	PC	SNA
2007-000084	R551	4. 7Kohm, 5%, 1/10W, TP, 1608	1	PC	SNA
2007-000084	R552	4. 7Kohm, 5%, 1/10W, TP, 1608	1	PC	SNA
2007-000084	R553	4. 7Kohm, 5%, 1/10W, TP, 1608	1	PC	SNA
2007-000084	R554	4. 7Kohm, 5%, 1/10W, TP, 1608	1	PC	SNA

Electrical Part List

Parts Code	Design location	Spec.	Quantity	Unit	Service
2007-000084	R555	4.7Kohm, 5%, 1/10W, TP, 1608	1	PC	SNA
2007-000084	R556	4.7Kohm, 5%, 1/10W, TP, 1608	1	PC	SNA
2007-000084	R559	4.7Kohm, 5%, 1/10W, TP, 1608	1	PC	SNA
2007-000084	R560	4.7Kohm, 5%, 1/10W, TP, 1608	1	PC	SNA
2007-000084	R561	4.7Kohm, 5%, 1/10W, TP, 1608	1	PC	SNA
2007-000084	R563	4.7Kohm, 5%, 1/10W, TP, 1608	1	PC	SNA
2007-000084	R663	4.7Kohm, 5%, 1/10W, TP, 1608	1	PC	SNA
2007-000084	R903	4.7Kohm, 5%, 1/10W, TP, 1608	1	PC	SNA
2007-000090	R159	10Kohm, 5%, 1/10W, TP, 1608	1	PC	SNA
2007-000090	R160	10Kohm, 5%, 1/10W, TP, 1608	1	PC	SNA
2007-000090	R207	10Kohm, 5%, 1/10W, TP, 1608	1	PC	SNA
2007-000090	R208	10Kohm, 5%, 1/10W, TP, 1608	1	PC	SNA
2007-000090	R301	10Kohm, 5%, 1/10W, TP, 1608	1	PC	SNA
2007-000090	R302	10Kohm, 5%, 1/10W, TP, 1608	1	PC	SNA
2007-000090	R304	10Kohm, 5%, 1/10W, TP, 1608	1	PC	SNA
2007-000090	R305	10Kohm, 5%, 1/10W, TP, 1608	1	PC	SNA
2007-000090	R502	10Kohm, 5%, 1/10W, TP, 1608	1	PC	SNA
2007-000090	R508	10Kohm, 5%, 1/10W, TP, 1608	1	PC	SNA
2007-000093	R469	20Kohm, 5%, 1/10W, TP, 1608	1	PC	SNA
2007-000093	R472	20Kohm, 5%, 1/10W, TP, 1608	1	PC	SNA
2007-000093	R473	20Kohm, 5%, 1/10W, TP, 1608	1	PC	SNA
2007-000106	R506	220Kohm, 5%, 1/10W, TP, 1608	1	PC	SNA
2007-000109	R205	1Mohm, 5%, 1/10W, TP, 1608	1	PC	SNA
2007-000109	R503	1Mohm, 5%, 1/10W, TP, 1608	1	PC	SNA
2007-000116	R201	120ohm, 5%, 1/10W, TP, 1608	1	PC	SNA
2007-000116	R306	120ohm, 5%, 1/10W, TP, 1608	1	PC	SNA
2007-000227	R167	1.2Mohm, 5%, 1/4W, TP, 3216	1	PC	SNA
2007-000263	R614	1.82Kohm, 1%, 1/8W, TP, 2012	1	PC	SNA
2007-000263	R616	1.82Kohm, 1%, 1/8W, TP, 2012	1	PC	SNA
2007-000290	R562	100ohm, 5%, 1/8W, TP, 2012	1	PC	SNA
2007-000300	R901	10Kohm, 5%, 1/8W, TP, 2012	1	PC	SNA
2007-000431	R664	16Kohm, 5%, 1/10W, TP, 1608	1	PC	SNA
2007-000455	R251	18Kohm, 1%, 1/10W, TP, 1608	1	PC	SNA
2007-000455	R253	18Kohm, 1%, 1/10W, TP, 1608	1	PC	SNA
2007-000468	R801	1Kohm, 5%, 1/8W, TP, 2012	1	PC	SNA
2007-000468	R802	1Kohm, 5%, 1/8W, TP, 2012	1	PC	SNA
2007-000468	R803	1Kohm, 5%, 1/8W, TP, 2012	1	PC	SNA
2007-000481	R163	1Mohm, 5%, 1/4W, TP, 3216	1	PC	SNA
2007-000481	R164	1Mohm, 5%, 1/4W, TP, 3216	1	PC	SNA
2007-000481	R165	1Mohm, 5%, 1/4W, TP, 3216	1	PC	SNA
2007-000614	R252	24Kohm, 1%, 1/10W, TP, 1608	1	PC	SNA
2007-000614	R258	24Kohm, 1%, 1/10W, TP, 1608	1	PC	SNA
2007-000614	R470	24Kohm, 1%, 1/10W, TP, 1608	1	PC	SNA
2007-000614	R471	24Kohm, 1%, 1/10W, TP, 1608	1	PC	SNA
2007-000614	R474	24Kohm, 1%, 1/10W, TP, 1608	1	PC	SNA
2007-000614	R475	24Kohm, 1%, 1/10W, TP, 1608	1	PC	SNA
2007-000614	R478	24Kohm, 1%, 1/10W, TP, 1608	1	PC	SNA
2007-000669	R476	2Kohm, 1%, 1/10W, TP, 1608	1	PC	SNA
2007-000669	R477	2Kohm, 1%, 1/10W, TP, 1608	1	PC	SNA
2007-000669	R651	2Kohm, 1%, 1/10W, TP, 1608	1	PC	SNA

Electrical Part List

Parts Code	Design location	Spec.	Quantity	Unit	Service
2007-000683	R454	3. 3Kohm, 1%, 1/10W, TP, 1608	1	PC	SNA
2007-000683	R459	3. 3Kohm, 1%, 1/10W, TP, 1608	1	PC	SNA
2007-000683	R466	3. 3Kohm, 1%, 1/10W, TP, 1608	1	PC	SNA
2007-000708	R655	3. 9Kohm, 1%, 1/10W, TP, 1608	1	PC	SNA
2007-000842	R661	3Kohm, 1%, 1/10W, TP, 1608	1	PC	SNA
2007-000842	R662	3Kohm, 1%, 1/10W, TP, 1608	1	PC	SNA
2007-000924	R106	470Kohm, 1%, 1/4W, TP, 3216	1	PC	SNA
2007-000924	R107	470Kohm, 1%, 1/4W, TP, 3216	1	PC	SNA
2007-000924	R108	470Kohm, 1%, 1/4W, TP, 3216	1	PC	SNA
2007-000924	R658	470Kohm, 1%, 1/4W, TP, 3216	1	PC	SNA
2007-000924	R659	470Kohm, 1%, 1/4W, TP, 3216	1	PC	SNA
2007-000924	R660	470Kohm, 1%, 1/4W, TP, 3216	1	PC	SNA
2007-000929	R153	470ohm, 1%, 1/10W, TP, 1608	1	PC	SNA
2007-000929	R154	470ohm, 1%, 1/10W, TP, 1608	1	PC	SNA
2007-000939	R652	47Kohm, 1%, 1/10W, TP, 1608	1	PC	SNA
2007-000962	R055	5. 1Kohm, 1%, 1/10W, TP, 1608	1	PC	SNA
2007-000962	R162	5. 1Kohm, 1%, 1/10W, TP, 1608	1	PC	SNA
2007-000979	R654	5. 6Kohm, 1%, 1/10W, TP, 1608	1	PC	SNA
2007-001067	R657	6. 8Kohm, 1%, 1/8W, TP, 2012	1	PC	SNA
2007-001068	R491	6. 8Kohm, 1%, 1/10W, TP, 1608	1	PC	SNA
2007-001071	R902	6. 8Kohm, 5%, 1/8W, TP, 2012	1	PC	SNA
2007-001074	R152	6. 8ohm, 5%, 1/8W, TP, 2012	1	PC	SNA
2007-001174	R104	8. 25Kohm, 1%, 1/4W, TP, 3216	1	PC	SNA
2007-001175	R056	8. 2Kohm, 1%, 1/10W, TP, 1608	1	PC	SNA
2007-001175	R410	8. 2Kohm, 1%, 1/10W, TP, 1608	1	PC	SNA
2007-002637	R611	60. 4Kohm, 1%, 1/4W, TP, 3216	1	PC	SNA
2007-002637	R612	60. 4Kohm, 1%, 1/4W, TP, 3216	1	PC	SNA
2007-002637	R613	60. 4Kohm, 1%, 1/4W, TP, 3216	1	PC	SNA
2007-002637	R615	60. 4Kohm, 1%, 1/4W, TP, 3216	1	PC	SNA
2007-002637	R617	60. 4Kohm, 1%, 1/4W, TP, 3216	1	PC	SNA
2007-002637	R618	60. 4Kohm, 1%, 1/4W, TP, 3216	1	PC	SNA
2007-007225	R161	1. 62Kohm, 1%, 1/10W, TP, 1608	1	PC	SNA
2007-007225	R455	1. 62Kohm, 1%, 1/10W, TP, 1608	1	PC	SNA
2007-007225	R457	1. 62Kohm, 1%, 1/10W, TP, 1608	1	PC	SNA
2007-007225	R468	1. 62Kohm, 1%, 1/10W, TP, 1608	1	PC	SNA
2007-007225	R492	1. 62Kohm, 1%, 1/10W, TP, 1608	1	PC	SNA
2007-008003	R513	4. 7Mohm, 1%, 1/10W, TP, 1608	1	PC	SNA
2007-010245	R062	0. 01ohm, 1%, 2W, TP, 6432	1	PC	SNA
2007-010245	R063	0. 01ohm, 1%, 2W, TP, 6432	1	PC	SNA
2007-010245	R451	0. 01ohm, 1%, 2W, TP, 6432	1	PC	SNA
2007-010245	R452	0. 01ohm, 1%, 2W, TP, 6432	1	PC	SNA
2007-010245	R453	0. 01ohm, 1%, 2W, TP, 6432	1	PC	SNA
2203-000236	C054	0. 1nF, 5%, 50V, COG, TP, 1608	1	PC	SNA
2203-000257	C053	10nF, 10%, 50V, X7R, TP, 1608	1	PC	SNA
2203-000257	C057	10nF, 10%, 50V, X7R, TP, 1608	1	PC	SNA
2203-000257	C301	10nF, 10%, 50V, X7R, TP, 1608	1	PC	SNA
2203-000257	C351	10nF, 10%, 50V, X7R, TP, 1608	1	PC	SNA
2203-000257	C352	10nF, 10%, 50V, X7R, TP, 1608	1	PC	SNA
2203-000257	C517	10nF, 10%, 50V, X7R, TP, 1608	1	PC	SNA
2203-000257	C518	10nF, 10%, 50V, X7R, TP, 1608	1	PC	SNA

Electrical Part List

Parts Code	Design location	Spec.	Quantity	Unit	Service
2203-000257	C520	10nF, 10%, 50V, X7R, TP, 1608	1	PC	SNA
2203-000257	C611	10nF, 10%, 50V, X7R, TP, 1608	1	PC	SNA
2203-000257	C612	10nF, 10%, 50V, X7R, TP, 1608	1	PC	SNA
2203-000257	C613	10nF, 10%, 50V, X7R, TP, 1608	1	PC	SNA
2203-000257	C651	10nF, 10%, 50V, X7R, TP, 1608	1	PC	SNA
2203-000257	C904	10nF, 10%, 50V, X7R, TP, 1608	1	PC	SNA
2203-000257	C951	10nF, 10%, 50V, X7R, TP, 1608	1	PC	SNA
2203-000257	C952	10nF, 10%, 50V, X7R, TP, 1608	1	PC	SNA
2203-000257	C953	10nF, 10%, 50V, X7R, TP, 1608	1	PC	SNA
2203-000257	C954	10nF, 10%, 50V, X7R, TP, 1608	1	PC	SNA
2203-000440	C404	1nF, 10%, 50V, X7R, TP, 1608	1	PC	SNA
2203-000440	C406	1nF, 10%, 50V, X7R, TP, 1608	1	PC	SNA
2203-000440	C407	1nF, 10%, 50V, X7R, TP, 1608	1	PC	SNA
2203-000440	C409	1nF, 10%, 50V, X7R, TP, 1608	1	PC	SNA
2203-000440	C410	1nF, 10%, 50V, X7R, TP, 1608	1	PC	SNA
2203-000440	C411	1nF, 10%, 50V, X7R, TP, 1608	1	PC	SNA
2203-000440	C414	1nF, 10%, 50V, X7R, TP, 1608	1	PC	SNA
2203-000440	C501	1nF, 10%, 50V, X7R, TP, 1608	1	PC	SNA
2203-000440	C514	1nF, 10%, 50V, X7R, TP, 1608	1	PC	SNA
2203-000440	C515	1nF, 10%, 50V, X7R, TP, 1608	1	PC	SNA
2203-000440	C516	1nF, 10%, 50V, X7R, TP, 1608	1	PC	SNA
2203-000783	C455	0.33nF, 5%, 50V, COG, 1608	1	PC	SNA
2203-000783	C458	0.33nF, 5%, 50V, COG, 1608	1	PC	SNA
2203-002002	C453	0.033nF, 5%, 50V, NP0, TP, 1608	1	PC	SNA
2203-002002	C454	0.033nF, 5%, 50V, NP0, TP, 1608	1	PC	SNA
2203-002002	C459	0.033nF, 5%, 50V, NP0, TP, 1608	1	PC	SNA
2203-002002	C550	0.033nF, 5%, 50V, NP0, TP, 1608	1	PC	SNA
2203-002002	C551	0.033nF, 5%, 50V, NP0, TP, 1608	1	PC	SNA
2203-002002	C552	0.033nF, 5%, 50V, NP0, TP, 1608	1	PC	SNA
2203-002002	C553	0.033nF, 5%, 50V, NP0, TP, 1608	1	PC	SNA
2203-002002	C558	0.033nF, 5%, 50V, NP0, TP, 1608	1	PC	SNA
2203-002002	C559	0.033nF, 5%, 50V, NP0, TP, 1608	1	PC	SNA
2203-005249	C051	100nF, 10%, 50V, X7R, TP, 1608	1	PC	SNA
2203-005249	C052	100nF, 10%, 50V, X7R, TP, 1608	1	PC	SNA
2203-005249	C156	100nF, 10%, 50V, X7R, TP, 1608	1	PC	SNA
2203-005249	C157	100nF, 10%, 50V, X7R, TP, 1608	1	PC	SNA
2203-005249	C158	100nF, 10%, 50V, X7R, TP, 1608	1	PC	SNA
2203-005249	C159	100nF, 10%, 50V, X7R, TP, 1608	1	PC	SNA
2203-005249	C160	100nF, 10%, 50V, X7R, TP, 1608	1	PC	SNA
2203-005249	C161	100nF, 10%, 50V, X7R, TP, 1608	1	PC	SNA
2203-005249	C162	100nF, 10%, 50V, X7R, TP, 1608	1	PC	SNA
2203-005249	C163	100nF, 10%, 50V, X7R, TP, 1608	1	PC	SNA
2203-005249	C200	100nF, 10%, 50V, X7R, TP, 1608	1	PC	SNA
2203-005249	C202	100nF, 10%, 50V, X7R, TP, 1608	1	PC	SNA
2203-005249	C203	100nF, 10%, 50V, X7R, TP, 1608	1	PC	SNA
2203-005249	C204	100nF, 10%, 50V, X7R, TP, 1608	1	PC	SNA
2203-005249	C205	100nF, 10%, 50V, X7R, TP, 1608	1	PC	SNA
2203-005249	C206	100nF, 10%, 50V, X7R, TP, 1608	1	PC	SNA
2203-005249	C207	100nF, 10%, 50V, X7R, TP, 1608	1	PC	SNA
2203-005249	C208	100nF, 10%, 50V, X7R, TP, 1608	1	PC	SNA

Electrical Part List

Parts Code	Design location	Spec.	Quantity	Unit	Service
2203-005249	C210	100nF, 10%, 50V, X7R, TP, 1608	1	PC	SNA
2203-005249	C211	100nF, 10%, 50V, X7R, TP, 1608	1	PC	SNA
2203-005249	C212	100nF, 10%, 50V, X7R, TP, 1608	1	PC	SNA
2203-005249	C230	100nF, 10%, 50V, X7R, TP, 1608	1	PC	SNA
2203-005249	C231	100nF, 10%, 50V, X7R, TP, 1608	1	PC	SNA
2203-005249	C232	100nF, 10%, 50V, X7R, TP, 1608	1	PC	SNA
2203-005249	C233	100nF, 10%, 50V, X7R, TP, 1608	1	PC	SNA
2203-005249	C251	100nF, 10%, 50V, X7R, TP, 1608	1	PC	SNA
2203-005249	C252	100nF, 10%, 50V, X7R, TP, 1608	1	PC	SNA
2203-005249	C253	100nF, 10%, 50V, X7R, TP, 1608	1	PC	SNA
2203-005249	C254	100nF, 10%, 50V, X7R, TP, 1608	1	PC	SNA
2203-005249	C302	100nF, 10%, 50V, X7R, TP, 1608	1	PC	SNA
2203-005249	C303	100nF, 10%, 50V, X7R, TP, 1608	1	PC	SNA
2203-005249	C304	100nF, 10%, 50V, X7R, TP, 1608	1	PC	SNA
2203-005249	C305	100nF, 10%, 50V, X7R, TP, 1608	1	PC	SNA
2203-005249	C306	100nF, 10%, 50V, X7R, TP, 1608	1	PC	SNA
2203-005249	C307	100nF, 10%, 50V, X7R, TP, 1608	1	PC	SNA
2203-005249	C401	100nF, 10%, 50V, X7R, TP, 1608	1	PC	SNA
2203-005249	C402	100nF, 10%, 50V, X7R, TP, 1608	1	PC	SNA
2203-005249	C403	100nF, 10%, 50V, X7R, TP, 1608	1	PC	SNA
2203-005249	C408	100nF, 10%, 50V, X7R, TP, 1608	1	PC	SNA
2203-005249	C460	100nF, 10%, 50V, X7R, TP, 1608	1	PC	SNA
2203-005249	C506	100nF, 10%, 50V, X7R, TP, 1608	1	PC	SNA
2203-005249	C507	100nF, 10%, 50V, X7R, TP, 1608	1	PC	SNA
2203-005249	C508	100nF, 10%, 50V, X7R, TP, 1608	1	PC	SNA
2203-005249	C509	100nF, 10%, 50V, X7R, TP, 1608	1	PC	SNA
2203-005249	C510	100nF, 10%, 50V, X7R, TP, 1608	1	PC	SNA
2203-005249	C511	100nF, 10%, 50V, X7R, TP, 1608	1	PC	SNA
2203-005249	C512	100nF, 10%, 50V, X7R, TP, 1608	1	PC	SNA
2203-005249	C614	100nF, 10%, 50V, X7R, TP, 1608	1	PC	SNA
2203-005249	C615	100nF, 10%, 50V, X7R, TP, 1608	1	PC	SNA
2203-005249	C701	100nF, 10%, 50V, X7R, TP, 1608	1	PC	SNA
2203-005249	C702	100nF, 10%, 50V, X7R, TP, 1608	1	PC	SNA
2203-005249	C801	100nF, 10%, 50V, X7R, TP, 1608	1	PC	SNA
2203-005249	C903	100nF, 10%, 50V, X7R, TP, 1608	1	PC	SNA
2203-006104	C902	1000nF, 10%, 50V, X7R, TP, 3225, 2. 5T	1	PC	SNA
2203-006348	C201	1000nF, 10%, 25V, X5R, TP, 1608	1	PC	SNA
2203-006348	C209	1000nF, 10%, 25V, X5R, TP, 1608	1	PC	SNA
2203-006348	C213	1000nF, 10%, 25V, X5R, TP, 1608	1	PC	SNA
2203-006348	C502	1000nF, 10%, 25V, X5R, TP, 1608	1	PC	SNA
2203-006348	C503	1000nF, 10%, 25V, X5R, TP, 1608	1	PC	SNA
2203-006348	C504	1000nF, 10%, 25V, X5R, TP, 1608	1	PC	SNA
2203-006348	C505	1000nF, 10%, 25V, X5R, TP, 1608	1	PC	SNA
2203-006348	C521	1000nF, 10%, 25V, X5R, TP, 1608	1	PC	SNA
2402-001183	CE451	22uF, 20%, 16V, WT, TP, 5. 3X5. 3X6MM	1	PC	SNA
2402-001268	CE051	100uF, 20%, 25V, WT, TP, 8x6. 3mm	1	PC	SNA
2402-001268	CE405	100uF, 20%, 25V, WT, TP, 8x6. 3mm	1	PC	SNA
2402-001368	CE402	47uF, 20%, 25V, TP, 6. 3x4. 9mm	1	PC	SNA
2402-001368	CE403	47uF, 20%, 25V, TP, 6. 3x4. 9mm	1	PC	SNA
2402-001368	CE404	47uF, 20%, 25V, TP, 6. 3x4. 9mm	1	PC	SNA

Electrical Part List

Parts Code	Design location	Spec.	Quantity	Unit	Service
2404-001341	C219	10uF, 20%, 16V, SCS, TP, 3216	1	PC	SNA
2404-001341	C220	10uF, 20%, 16V, SCS, TP, 3216	1	PC	SNA
2703-003657	L152	3. 3uH, 20%, 3030	1	PC	SNA
2802-001165	X201	4MHz, 0. 5%, TP, 4. 5x2. 0x1. 15mm	1	PC	SNA
2802-001211	X501	8MHZ, 0. 1%, TP, 3. 2X1. 3X0. 9 MM	1	PC	SNA
DB13-00003A	Q901	-, SOT-23, -, -, 1P, 1P, 0. 2mm, 2. 93x1. 3mm	1	PC	SNA
DB41-01010A	PCB	JUNGFRAU-PJT, FR-	1	PC	SNA
DB91-01173A	IC501	JUNGFRAU OUTDOOR INV MICOM, STM-1040-	1	PC	SNA
DB09-00591A	IC501	LM3S817, 48, DC3V, 50	1	PC	SNA
DB91-01178A	IC201	Maldive Outdoor, STM-1042-OS, S3F4A1H,	1	PC	SNA
DB09-00535A	IC501	S3F4A1H, 100P, DC5V, 12 MHz, TQFP, 16	1	PC	SNA
DB93-11575A	-	MALDIVE-PJT, SSEC	1	PC	SNA
2003-000855	R151	47Kohm, 5%, 3W, AA, TP, 6x16mm	1	PC	SNA
2201-000322	C151	2. 2nF, 10%, 2000V, Y5P, 13x5mm, 10mm	1	PC	SNA
2201-000322	C152	2. 2nF, 10%, 2000V, Y5P, 13x5mm, 10mm	1	PC	SNA
2201-000322	C901	2. 2nF, 10%, 2000V, Y5P, 13x5mm, 10mm	1	PC	SNA
2201-000987	C153	2. 2nF, 20%, 400V, Y5U, TP, 12. 5x6mm, 10mm	1	PC	SNA
2201-000987	C154	2. 2nF, 20%, 400V, Y5U, TP, 12. 5x6mm, 10mm	1	PC	SNA
2201-002128	C004	4. 7nF, 20%, 400V, Y5U, BK, 15x7mm, 10mm	1	PC	SNA
2201-002128	C005	4. 7nF, 20%, 400V, Y5U, BK, 15x7mm, 10mm	1	PC	SNA
2201-002128	C012	4. 7nF, 20%, 400V, Y5U, BK, 15x7mm, 10mm	1	PC	SNA
2201-002128	C013	4. 7nF, 20%, 400V, Y5U, BK, 15x7mm, 10mm	1	PC	SNA
2201-002128	C061	4. 7nF, 20%, 400V, Y5U, BK, 15x7mm, 10mm	1	PC	SNA
2301-001325	C001	330nF, 10%, 275V, TP, 26x8. 5x18mm, 22. 5	1	PC	SNA
2301-001577	C006	1000nF, 10%, 275V, BK, 26. 5X21. 5X12. 5	1	PC	SNA
2306-000123	C060	100nF, 5%, 630V, BK, 26x16. 5x8. 5mm	1	PC	SNA
2306-000123	C400	100nF, 5%, 630V, BK, 26x16. 5x8. 5mm	1	PC	SNA
2401-000481	CE152	10uF, 20%, 50V, WT, TP, 5x11, 5	1	PC	SNA
2401-001548	CE159	47uF, 20%, 25V, WT, TP, 5x11, 5	1	PC	SNA
2401-001838	CE153	470uF, 20%, 25V, WT, TP, 10x16, 5	1	PC	SNA
2401-001838	CE154	470uF, 20%, 25V, WT, TP, 10x16, 5	1	PC	SNA
2401-001838	CE157	470uF, 20%, 25V, WT, TP, 10x16, 5	1	PC	SNA
2401-002438	CE902	47uF, 20%, 50V, WT, TP, 6. 3x11, 5mm	1	PC	SNA
2401-003224	CE155	470uF, 20%, 16V, WT, TP, 8X11. 5, 5mm	1	PC	SNA
2401-003224	CE156	470uF, 20%, 16V, WT, TP, 8X11. 5, 5mm	1	PC	SNA
2401-003224	CE158	470uF, 20%, 16V, WT, TP, 8X11. 5, 5mm	1	PC	SNA
2401-004267	CE151	22uF, 20%, 500V, TP, 16*25, 7. 5mm	1	PC	SNA
2401-004874	CE101	330uF, 20%, 400V, BK, 25. 4*50, 10mm	1	PC	SNA
2401-004874	CE102	330uF, 20%, 400V, BK, 25. 4*50, 10mm	1	PC	SNA
2401-004874	CE103	330uF, 20%, 400V, BK, 25. 4*50, 10mm	1	PC	SNA
2702-001110	L150	33uH, 10%, 9. 5x16mm	1	PC	SNA
3601-001538	F001	250V, 15A, TIME-LAG, CERAMIC, 6. 35x31. 8mm	1	PC	SNA
4715-001093	DSA	3600V, 20%, 2000A, -, AXIAL	1	PC	SNA
DB93-11568A	-	SI-PJT, SSEC	1	PC	SNA
0502-000245	IC156	KSB1151-Y, PNP, 1300mW, TO-126, 160-320	1	PC	SNA
1203-000002	IC157	431, TO-92, 3P, -	1	PC	SNA
1203-002735	IC153	KIA7815API, TO-	1	PC	SNA
1203-006089	IC151	TOP253PN, DIP, 7P, 6. 35x9. 57mm, PLASTIC, -	1	PC	SNA
1404-001274	NTC151	22ohm, 1. 4A, 3100K, 9. 5mW/C, -, 7. 0, -	1	PC	SNA
1404-001498	PTC020	40ohm, 25%, 290Vac, 7A, TR	1	PC	SNA

Electrical Part List

Parts Code	Design location	Spec.	Quantity	Unit	Service
1405-000154	VA002	460Vdc, 2500A, 17. 5x7. 5mm, TP	1	PC	SNA
1405-000154	VA003	460Vdc, 2500A, 17. 5x7. 5mm, TP	1	PC	SNA
1405-000160	VA001	680V, 4500A, 17. 5x6. 5mm, TP	1	PC	SNA
1405-000160	VA151	680V, 4500A, 17. 5x6. 5mm, TP	1	PC	SNA
3501-000273	RY021	12V, 540mW, 16000mA, 1FormA, 20ms, 6ms	1	PC	SNA
3501-001163	RY022	12V, 200mW, 5000mA, 1FormA, 10ms, 5ms	1	PC	SNA
3501-001163	RY030	12V, 200mW, 5000mA, 1FormA, 10ms, 5ms	1	PC	SNA
3704-001601	IC202	8P, SN, 2. 54mm	1	PC	SNA
3711-000296	CN901	1WALL, 6P, 1R, 3. 96MM, STRAIGHT, SN, WHT	1	PC	SNA
3711-000796	CN301	BOX, 2P, 1R, 2. 5MM, STRAIGHT, SN, RED	1	PC	SNA
3711-001031	CN701	BOX, 6P, 1R, 2. 5MM, ANGLE, SN, WHT	1	PC	SNA
3711-001036	CN251	BOX, 6P, 1R, 2. 5mm, STRAIGHT, SN, BLU	1	PC	SNA
3711-003380	CN030	1WALL, 2P, 1R, 7. 92MM, ANGLE, SN, WHT	1	PC	SNA
3711-004067	CN851	BOX, 4P, 1R, 2mm, ANGLE, SN, NTR	1	PC	SNA
3711-007656	CN451	BOX, 3, 1R, 6mm, STRAIGHT, WHT	1	PC	SNA
3711-007659	CN051	2, 1R, 7. 92mm, STRAIGHT, WHT	1	PC	SNA
3711-007717	CN551	BOX, 10P, 1R, 2mm, ANGLE, SN, RED	1	PC	SNA
3711-007718	CN201	BOX, 10P, 1R, 2mm, ANGLE, SN, BLK	1	PC	SNA
3712-001139	CN001	TAB, MALE, 6. 35x0. 8mm	1	PC	SNA
3712-001139	CN002	TAB, MALE, 6. 35x0. 8mm	1	PC	SNA
3712-001139	CN003	TAB, MALE, 6. 35x0. 8mm	1	PC	SNA
4719-002483	PFC050	Smart Power	1	PC	SNA
4719-002484	IPM400	Smart Power	1	PC	SNA
DB26-00120A	PT150	EE2525, TOP253PN(SI-	1	PC	SNA
DB27-00070A	FT301	CV005180SJ, JSF2, 18. 0, +50~-	1	PC	SNA
DB27-00077A	FT001	MALDIVE, 12mH, 22m, 15A	1	PC	SNA
DB61-04692A	IPM/PFCM UNDER	SI Inv(MALDIVES1 12k), PA66-	1	PC	SNA
DB67-00942A	VA001_1	VIVALDI-P/J, SHP2, -, -, -, GREEN, SSEC	1	PC	SNA
DB67-00942A	VA002_1	VIVALDI-P/J, SHP2, -, -, -, GREEN, SSEC	1	PC	SNA
DB67-00942A	VA003_1	VIVALDI-P/J, SHP2, -, -, -, GREEN, SSEC	1	PC	SNA
DB67-00942A	VA151_1	VIVALDI-P/J, SHP2, -, -, -, GREEN, SSEC	1	PC	SNA

7. Wiring Diagram

7-1 Indoor Unit

ASV09PSBANED

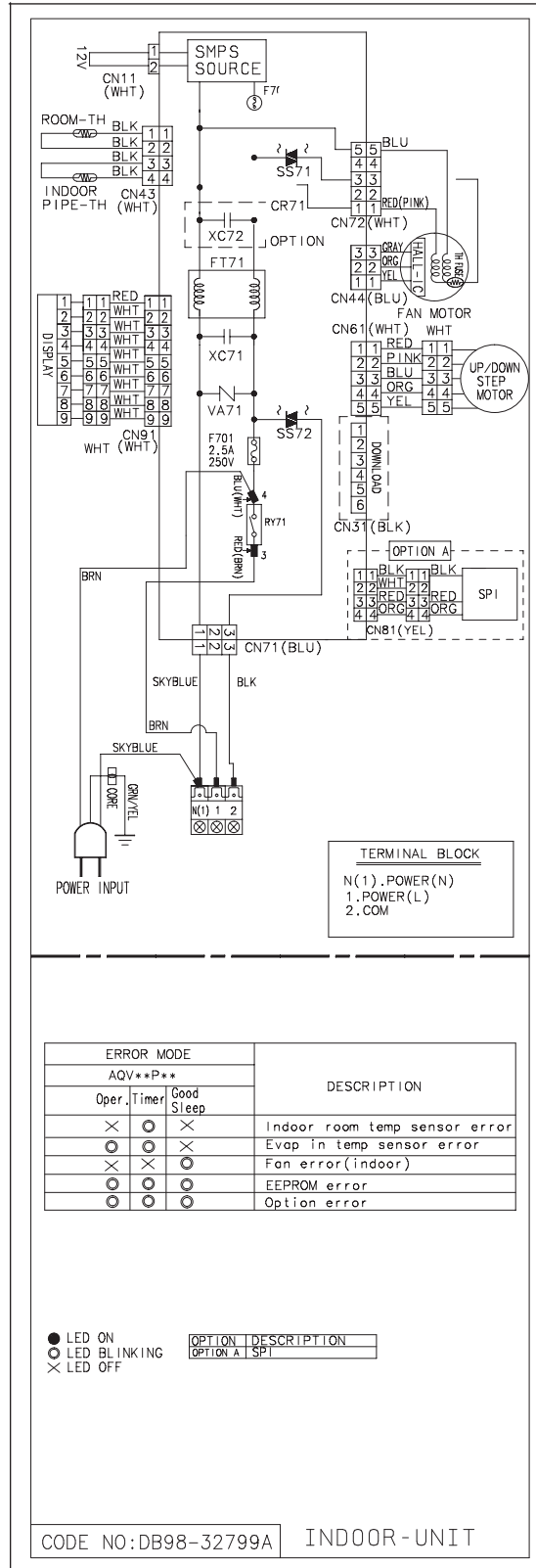

This Document can not be used without Samsung's authorization.

7. Wiring Diagram

7-1 Indoor Unit

ASV12PSBBNED

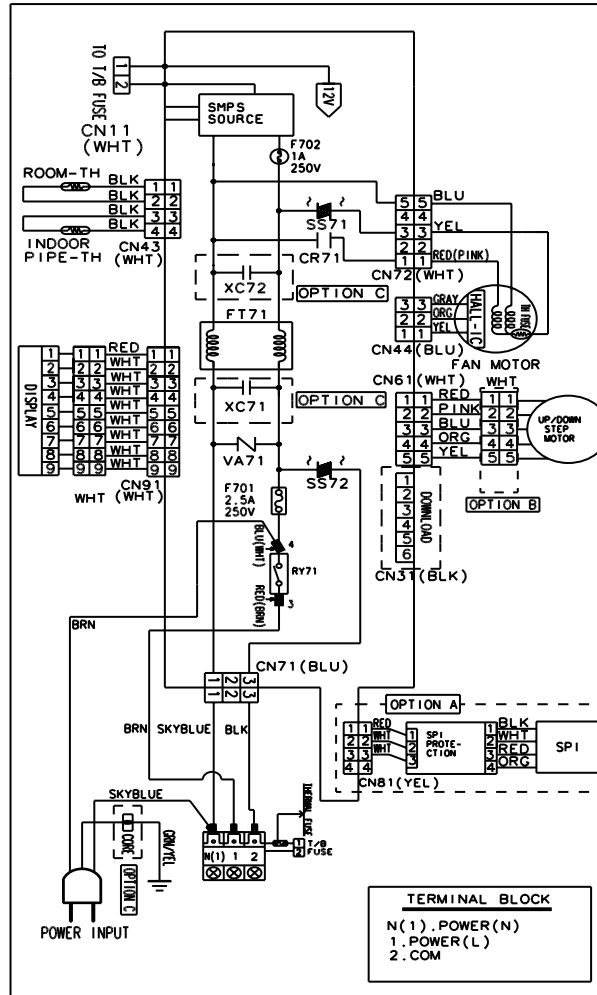

ERROR MODE			DESCRIPTION
Oper	Timer	Good Sleep or SPI (OPTION A)	
×	○	×	Indoor room temp sensor error
○	○	×	Evap in temp sensor error
×	×	○	Fan error(indoor)
○	○	○	EEPROM error
○	○	○	Option error

● LED ON
 ○ LED BLINKING
 × LED OFF

OPTION	DESCRIPTION
OPTION A	SPI OPTION
OPTION B	STEP MOTOR WIRE
OPTION C	EMI OPTION

• Note •
 If the Set doesn't work (No power), check the Thermal fuse of Terminal block OPEN or SHORT with Multimeter.
 (Measure the Thermal fuse housing PIN1 ~ 2 : OPEN(disconnection) → defective product!)

CODE NO:DB98-34105A INDOOR-UNIT

This Document can not be used without Samsung's authorization.

7. Wiring Diagram

7-1 Indoor Unit

ASV18PSBANED

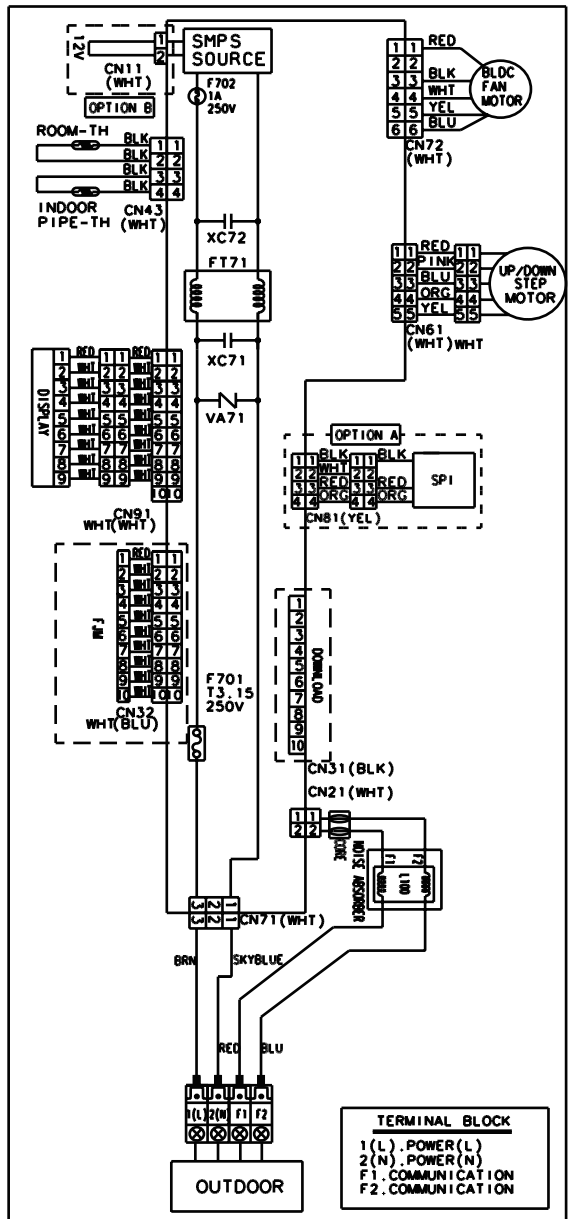

ERROR MODE			DESCRIPTION
AQV**P**/ASV**P**	Oper.	Timer	
X	○	○	Communication error (indoor ↔ outdoor) Pre power relay error
X	○	X	Indoor room temp sensor error
○	○	X	Temp in temp sensor error
X	X	○	Fan error (indoor)
○	X	○	Outdoor error display
○	○	○	EEPROM error
○	○	○	Option error

LED	OPTION	DESCRIPTION
● LED ON	OPTION A	OPTION A / SPI
○ LED BLINKING	OPTION B	OPTION B / 1/2 FUSE OPTION
X LED OFF		

CODE NO: DB98-32801A INDOOR - UNIT

This Document can not be used without Samsung's authorization.

7-2 Outdoor Unit

ASV09PSBANED/ASV12PSBBNED

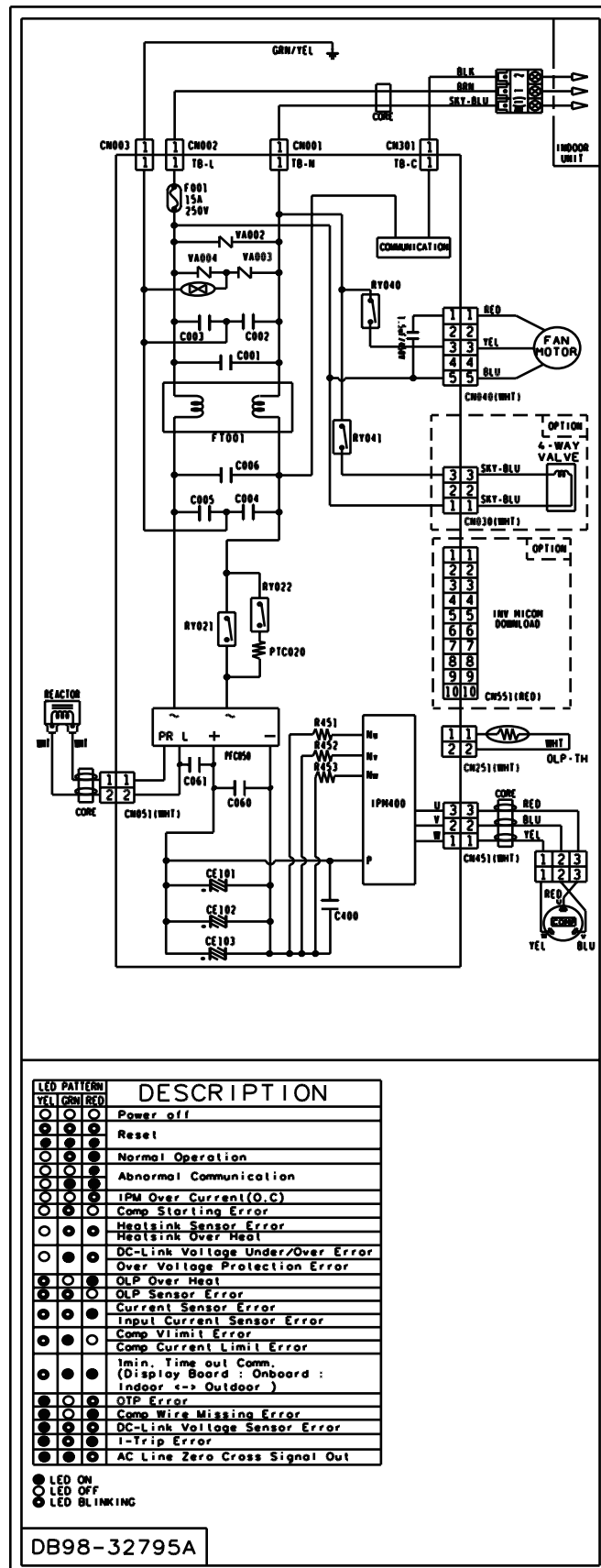

This Document can not be used without Samsung's authorization.

7-2 Outdoor Unit

ASV18PSBAXED

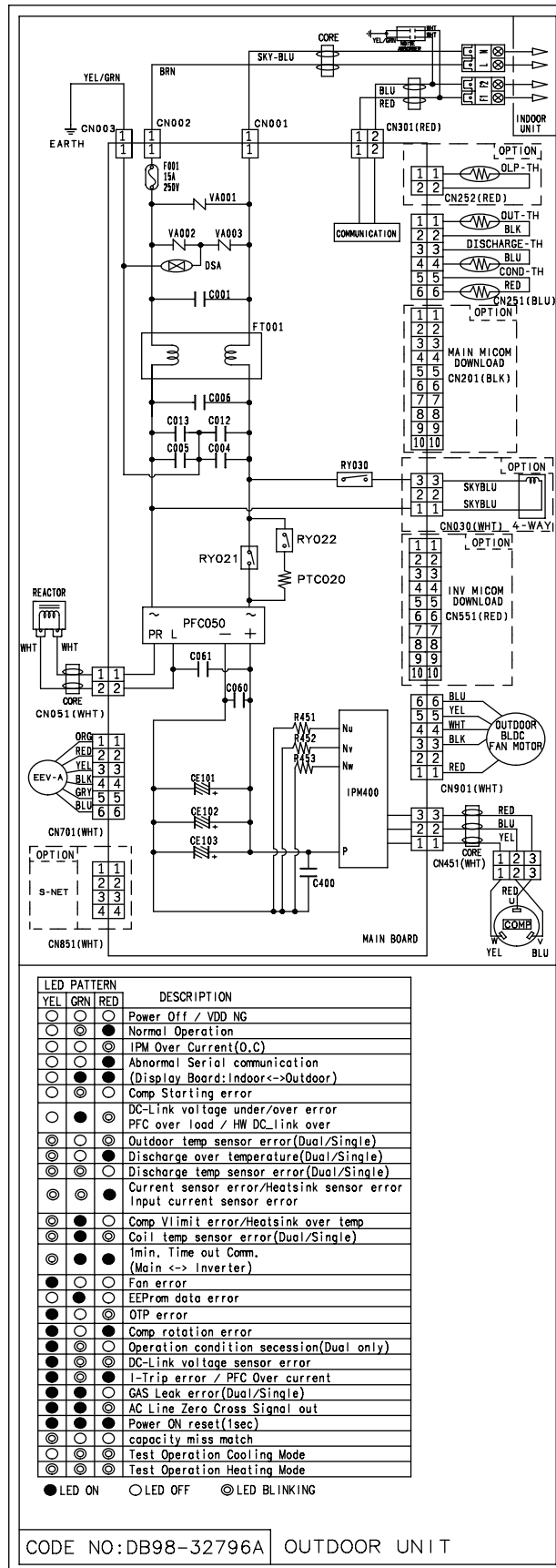

This Document can not be used without Samsung's authorization.

8. Schematic Diagram

8-1 Indoor Unit

ASV09PSBANED

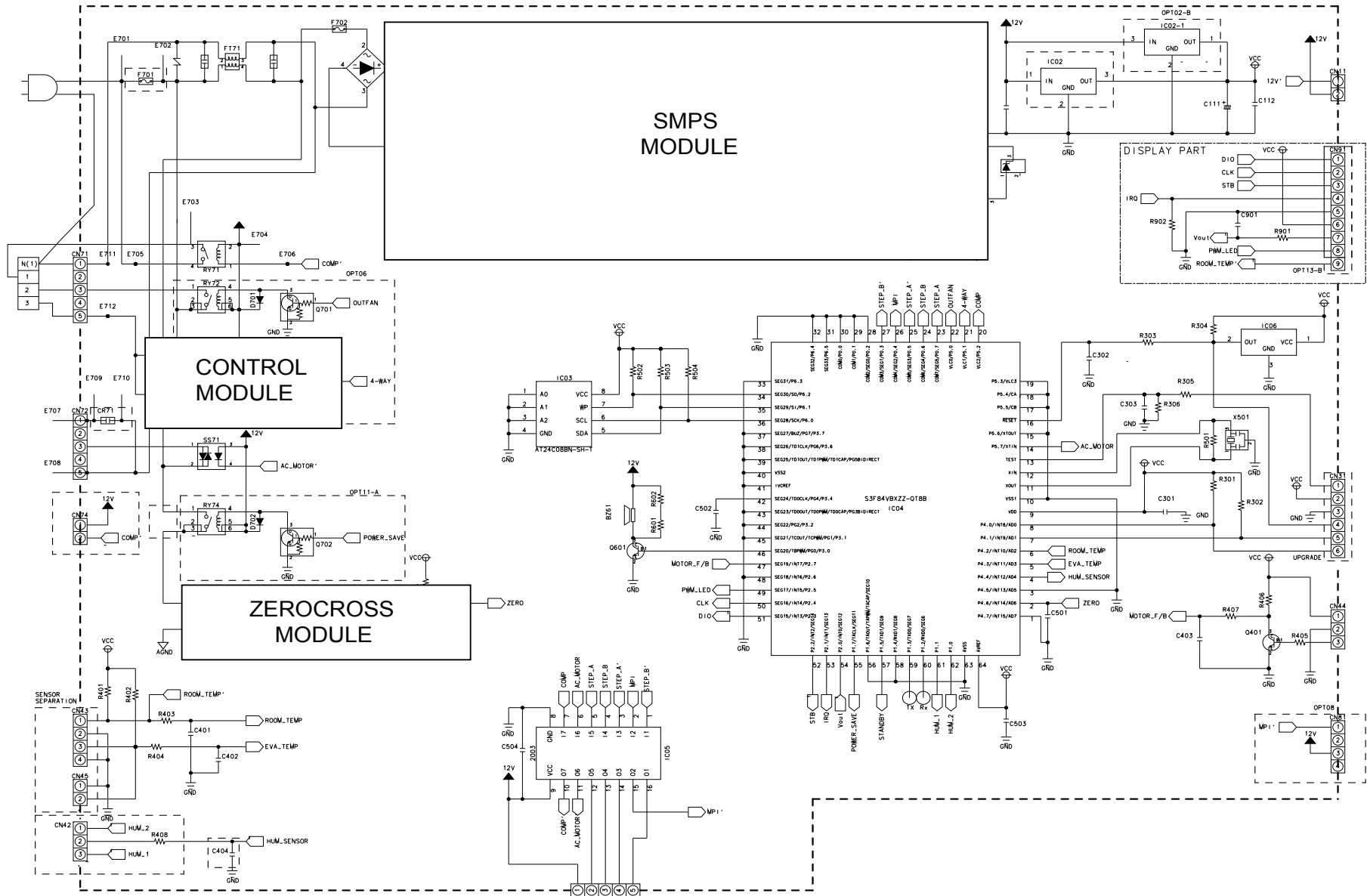

8. Schematic Diagram

8-1 Indoor Unit

ASV12PSBBND

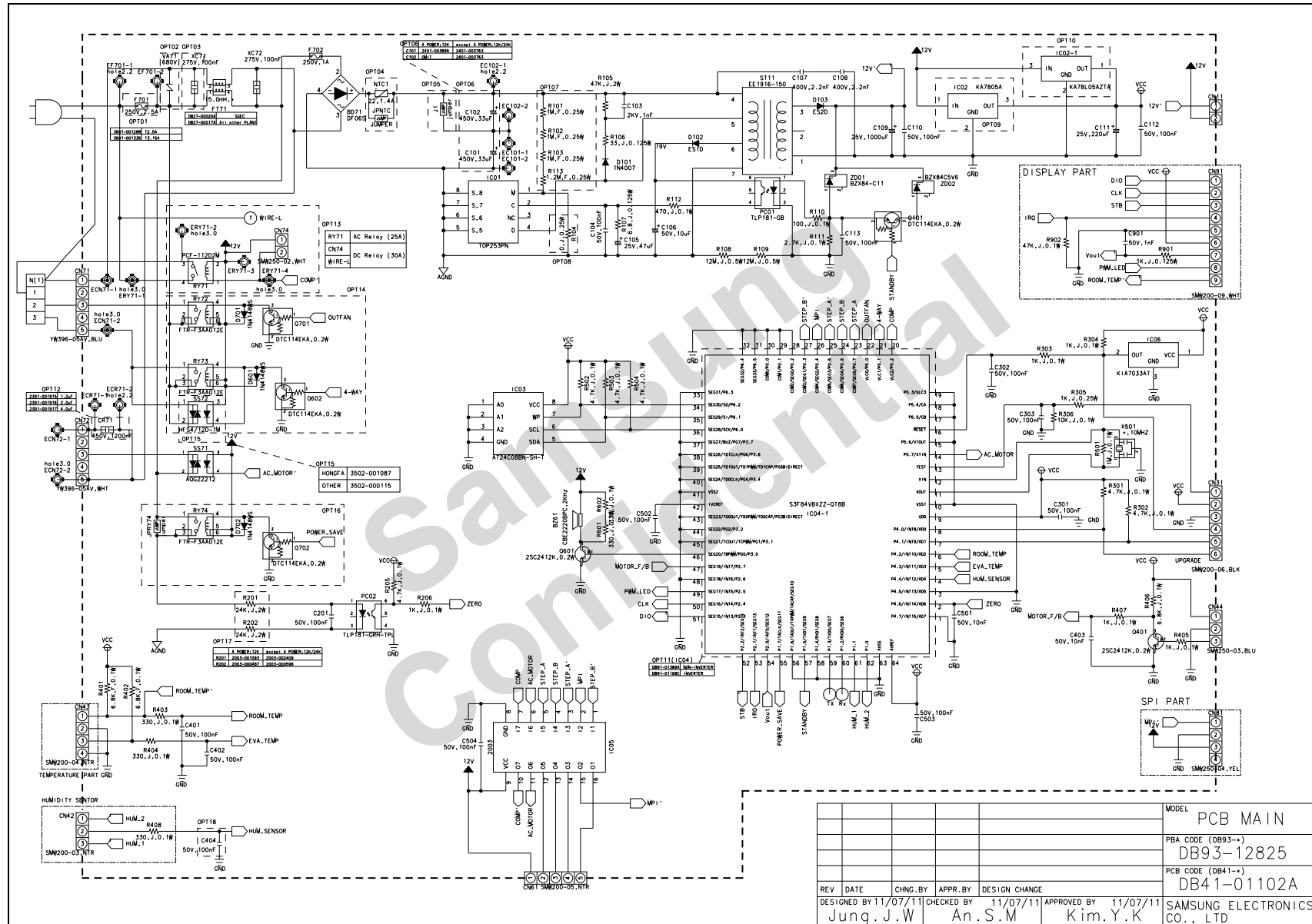

8-1 Indoor Unit

ASV18SPSBANED

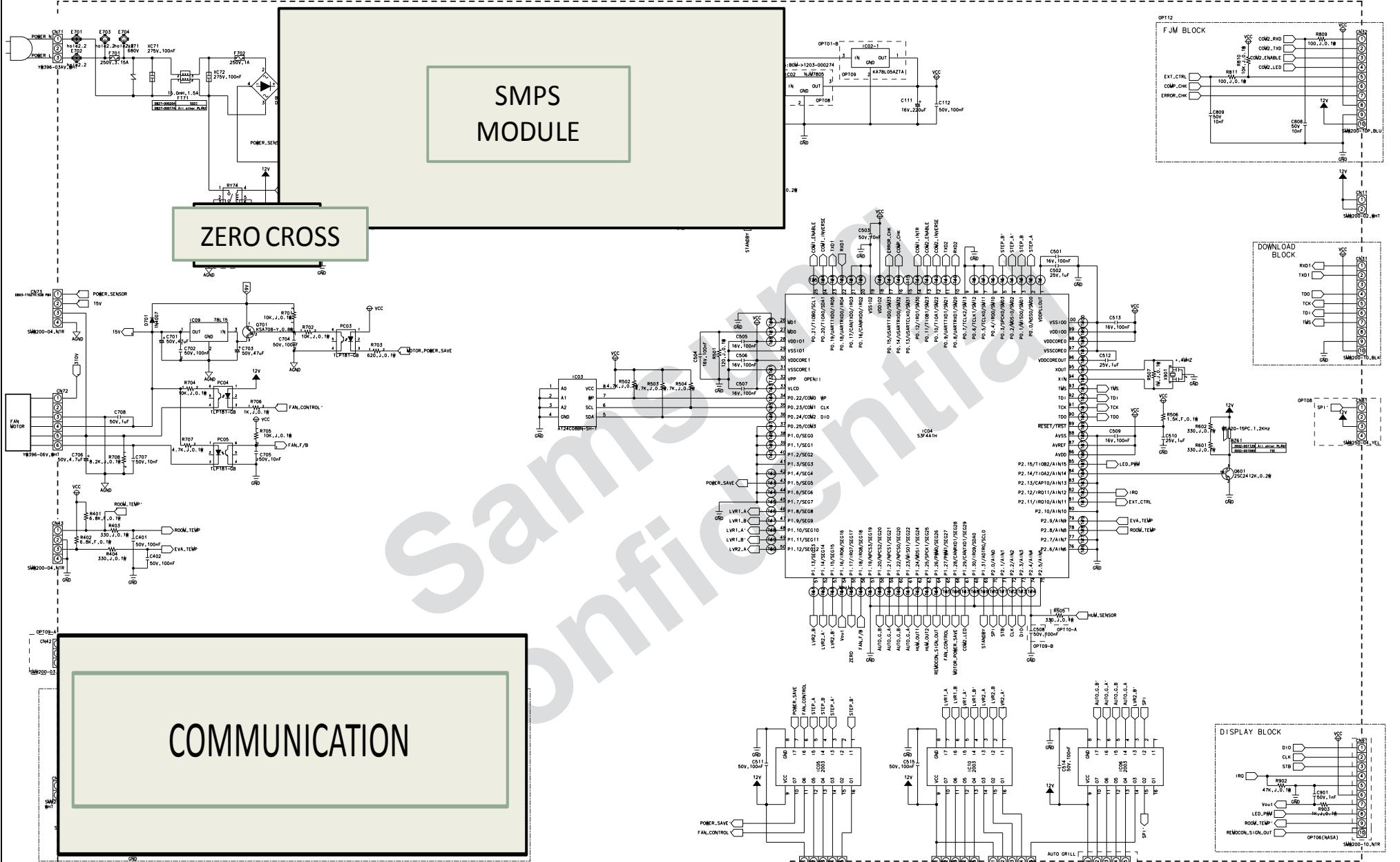

OPT10A	MOTOR EXP.	FUSE	VARISTOR	XC72	XC107	SMPS	SMPS	OVER	NO-OVER	VP1	REGULATOR	FAN	DOWNLOAD	DISPLAY	LED	AUTO	BUZZER	485	HAM/DI17	NO	NUM/DI17	ZERO
DB CODE	OPT01	OPT02	OPT03	OPT04	OPT05-A	OPT05-B	OPT06	OPT07	OPT08	OPT09	OPT10	OPT11	OPT12	OPT13	OPT14	OPT15	OPT16	OPT17	OPT18	OPT19	OPT20	OPT21
	F701	VA72	X	C102	C101																	
EV(-18K)	F701	VA71																				
EV(24K-)	F701	VA71																				
INDA																						

REV	DATE	CHNG. BY	APPR. BY	DESIGN CHANGE	DESIGNED BY	CHECKED BY	APPROVED BY	DATE	COMPANY
	10/04/07	Park.S.J	AN.S.M				Kim.Y.K	10/04/08	SAMSUNG ELECTRONICS CO., LTD

MODEL PCB MAIN
 PBA CODE (DB93-+) DB93-10956*
 PCB CODE (DB41-+) DB41-00975A

8-2 Outdoor Unit

ASV09PSBAXED/ASV12PSBBXED

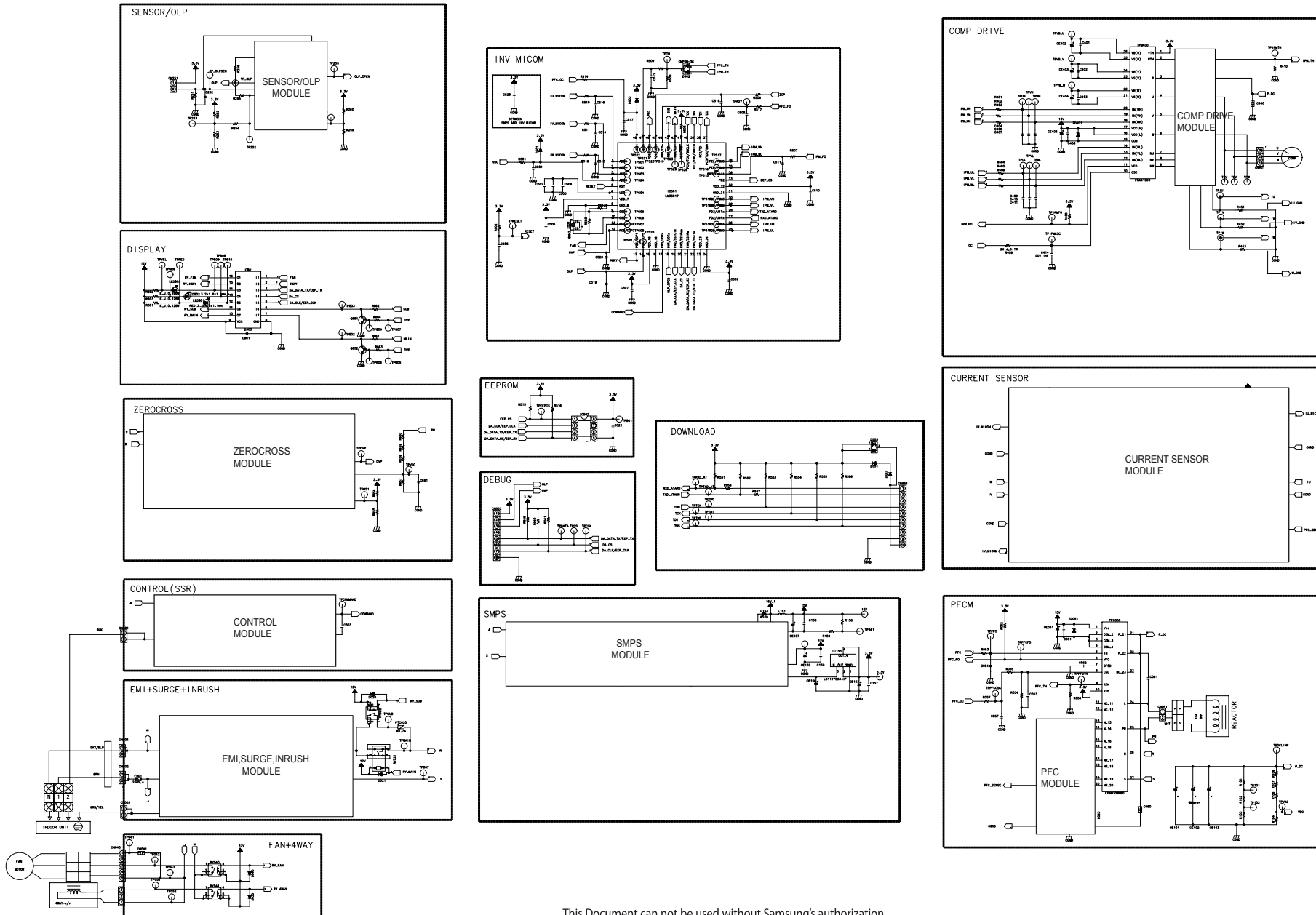

This Document can not be used without Samsung's authorization.

8-2 Outdoor Unit

ASV18PSBAXED

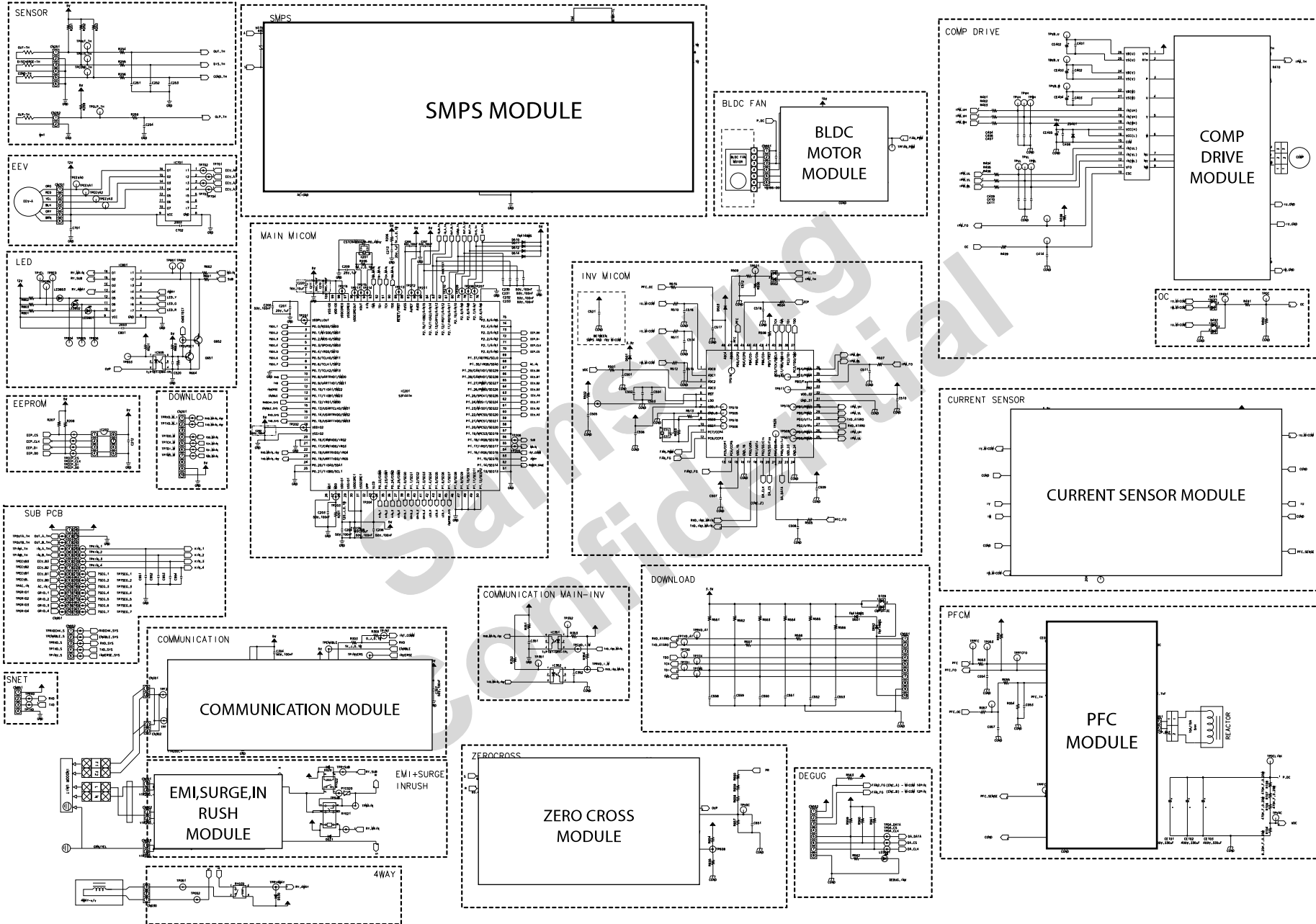

9 Refrigerating Cycle Diagram

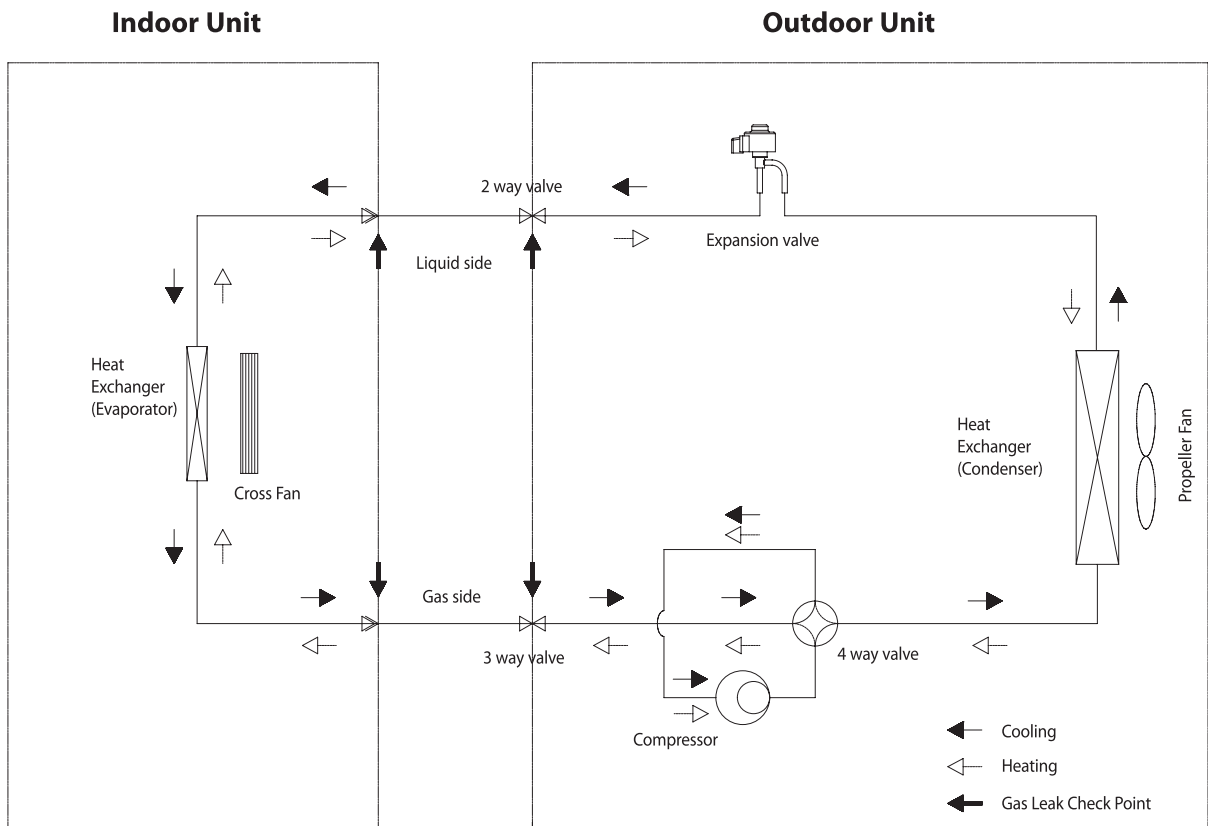

10. PCB Diagram

10-1 Indoor PCB

ASV09PSBANED

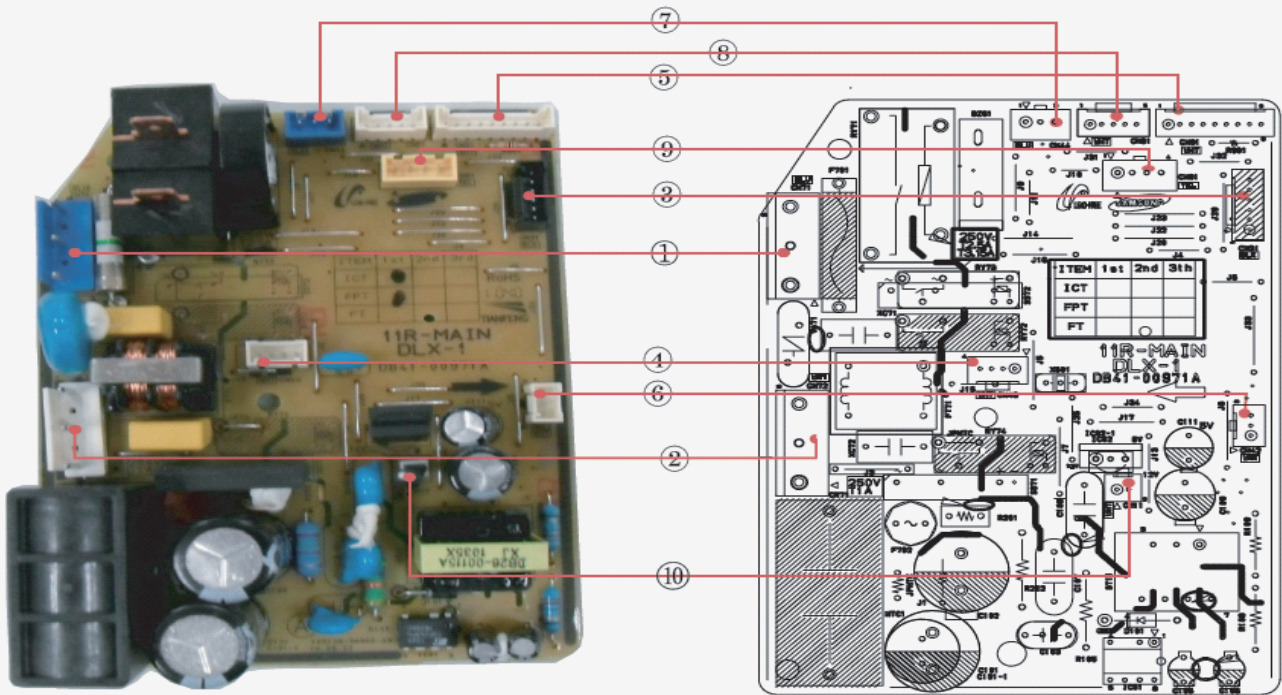

<p>①CN71(L-terminal) Power Input #1:POWER #2:LOAD CONTROL signal #3:LOAD CONTROL signal</p>	<p>②CN72-FAN MOTOR #1:Motor start Capacitor connect #3:AC phase control signal #5:Power</p>	<p>③CN31-DOWNLOAD #1:TEST #2:Vcc #3:GND #4:RESET #5:SDAT #6:SCLK</p>	<p>④CN43-TEMPERATURE SENSOR #1:Room temperature sensing #2:GND #3:Pipe temperature sensing #4:GND</p>
<p>⑤CN91-DISPLAY #1:DIO #2:CLK #3:STB #4:IRQ #5:GND #6:Vcc #7:Vovt #8:PWM_LED #9: ROOM-TEMP</p>	<p>⑥CN42-Humidity sensor #1:Output(P1) #2:Input #3:Output(P2)</p>	<p>⑦CN44-FAN MOTOR FEEDBACK #1:DC5V #2:GND #3:Feedback signal input</p>	<p>⑧CN61-STEP MOTOR #1:DC12V #2:Motor driving signal output_1 #3:Motor driving signal output_2 #4:Motor driving signal output_3 #5:Motor driving signal output_4</p>
<p>⑨CN81-SPI #1:MPI driving signal output (+) #3:DV12V</p>	<p>⑩CN11-12V CONNECT #1: SMPS Vovt(12V) #2:7805 INPUT(12V)</p>		

10. PCB Diagram

10-1 Indoor PCB

ASV12PSBBNED

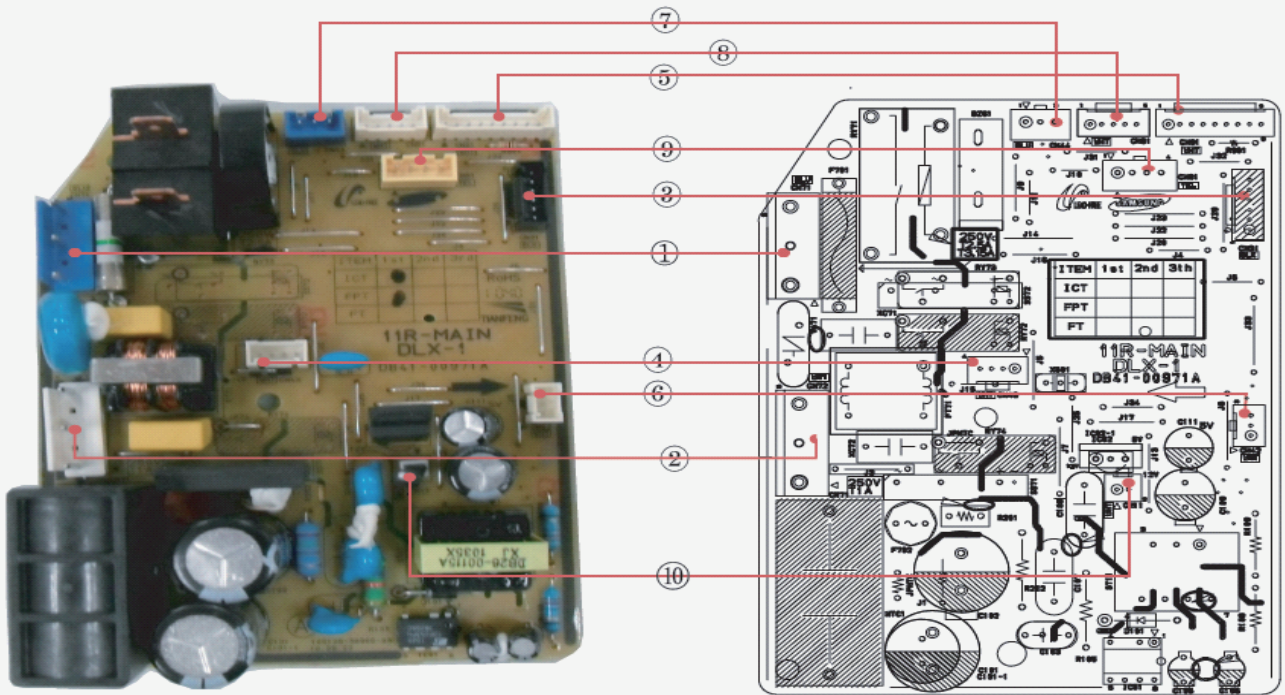

<p>①CN71(L -terminal) Power Input #1:POWER #2:LOAD CONTROL signal #3:LOAD CONTROL signal</p>	<p>②CN72-FAN MOTOR #1:Motor start Capacitor connect #3:AC phase control signal #5:Power</p>	<p>③CN31-DOWNLOAD #1:TEST #2:Vcc #3:GND #4:RESET #5:SDAT #6:SCLK</p>	<p>④CN43-TEMPERATURE SENSOR #1:Room temperature sensing #2:GND #3:Pipe temperature sensing #4:GND</p>
<p>⑤CN91-DISPLAY #1:DIO #2:CLK #3:STB #4:IRQ #5:GND #6:Vcc #7:Vovt #8:PWM_LED #9: ROOM-TEMP</p>	<p>⑥CN42-Humidity sensor #1:Output(P1) #2:Input #3:Output(P2)</p>	<p>⑦CN44-FAN MOTOR FEEDBACK #1:DC5V #2:GND #3:Feedback signal input</p>	<p>⑧CN61-STEP MOTOR #1:DC12V #2:Motor driving signal output_1 #3:Motor driving signal output_2 #4:Motor driving signal output_3 #5:Motor driving signal output_4</p>
<p>⑨CN81-SPI #1:MPI driving signal output (+) #3:DV12V</p>	<p>⑩CN11-12V CONNECT #1: SMPS Vovt(12V) #2:7805 INPUT(12V)</p>		

10-1 Indoor PCB

ASV18PSBANED

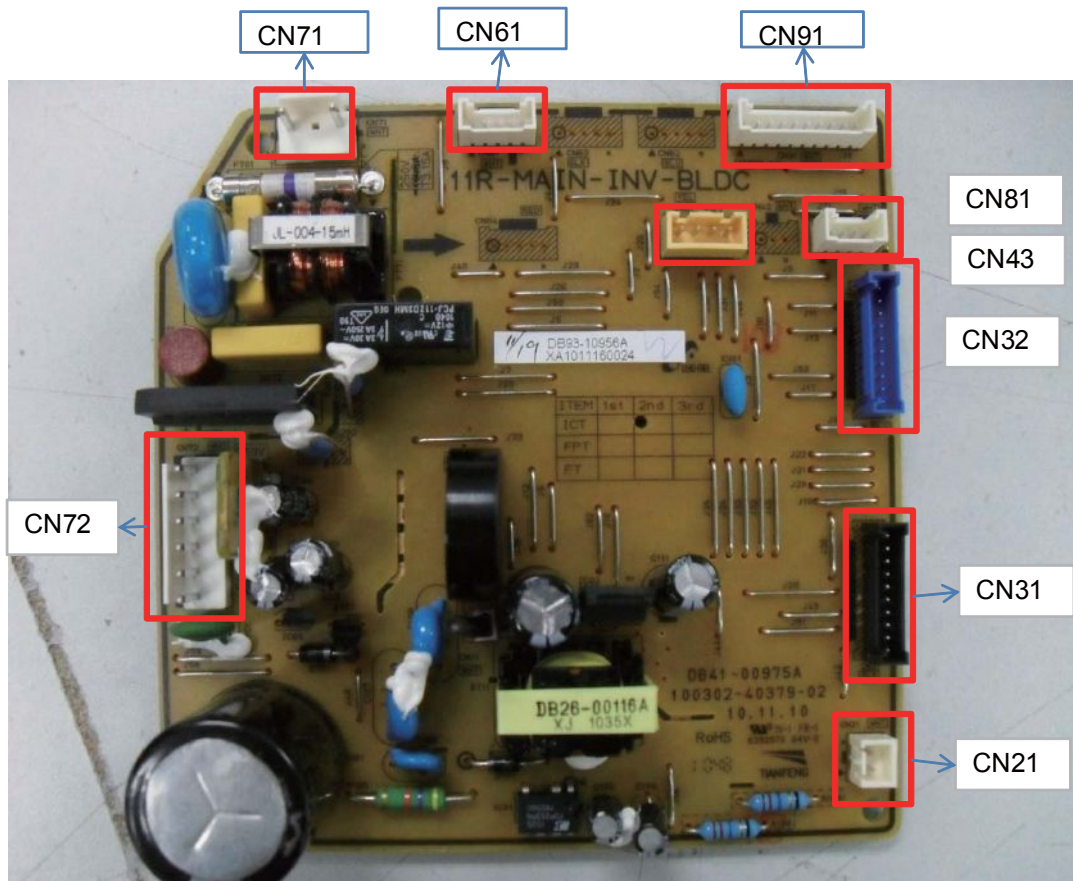

- 1.CN21-COMMUNICATION
- 2.CN31-DOWNLOAD
- 3.CN32-FJM
- 4.CN43-TEMPRATURE SENSOR
- 5.CN91-DISPLAY
- 6.CN81-MPI
- 7.CN61-STEP MOTOR
- 8.CN71-POWER IN
- 9.CN72-FAN MOTOR

10-2 Outdoor PCB

ASV09PSBAXED/ASV12PSBBXED

 The red number connector is not used.

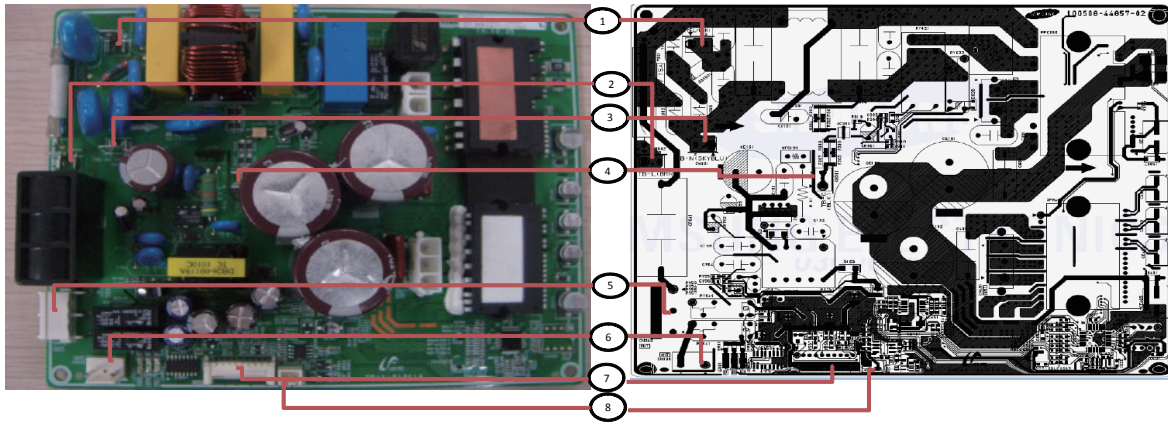

1. CN003—Earth Terminal
3. CN001—Power N Terminal
5. CN040—Fan Connector
7. CN551—Download Connector

2. CN002—Power L Terminal
4. CN301—Control Terminal
6. CN030—4Way Connector
8. CN251—SENSOR Connector
#1 #2 : OLP SENSOR

10-2 Outdoor PCB

ASV18PSBAXED

 The red number connector is not used.

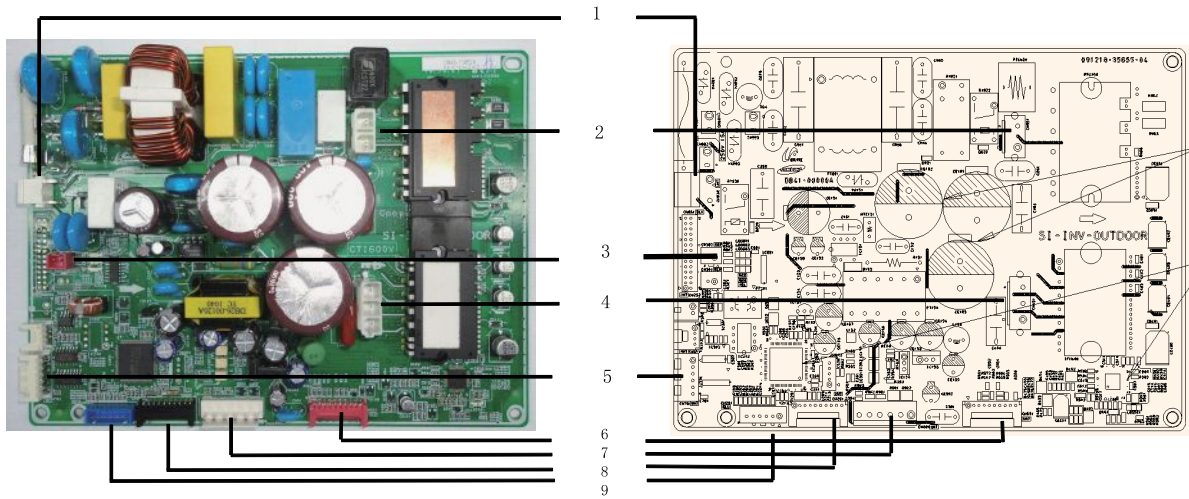

1. 4WAY	2. CN051-REACTOR	3. CN301-485 communication #1 F1 #2 F2	4. CN451-COMP #1 W phase	5. CN701-EEV #1 EEV signal
			#2 V phase	#2 EEV signal
			#3 U phase	#3 EEV signal
				#4 EEV signal
6. CN551-INV MICOM DOWNLOAD	7. CN901-BLDC FAN	8. CN201-MAIN MICOM DOWNLOAD	9. CN251-SENSOR #1 OUTDOOR TEMPERATURE	#5,6 12V
			#2 GND	
			#3 DISCHARGE TEMPERATURE	
			#4 GND	
			#5 COND TEMPERATURE	
			#6 GND	

11. Operating Instructions

11-1 Name of Each Part

11-1-1 Indoor Unit

The design and shape are subject to change according to the model.

Main parts

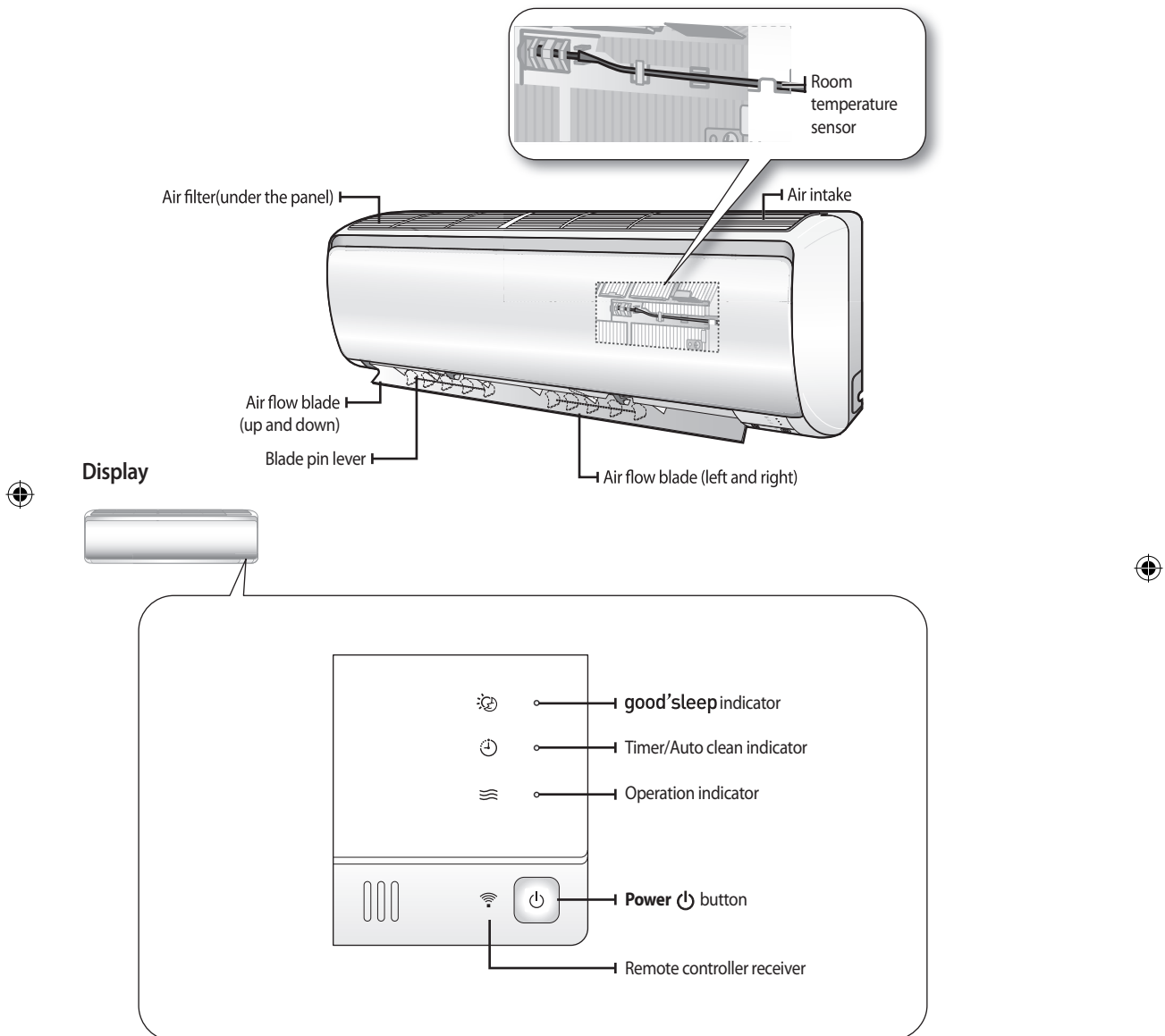

11-1-2 Outdoor Unit

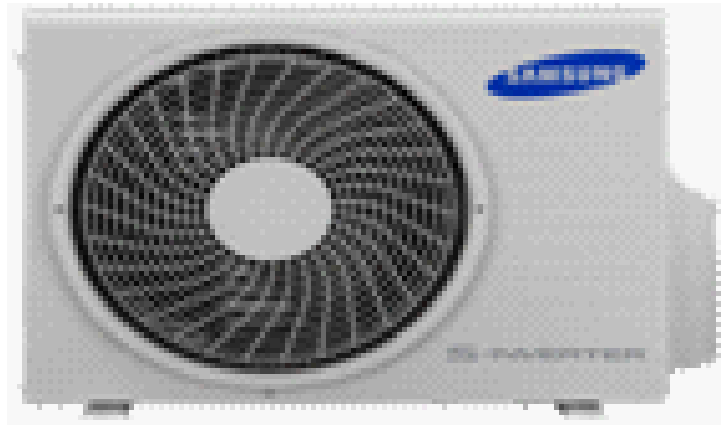

ASV09PSBAXED/ASV12PSBBXED

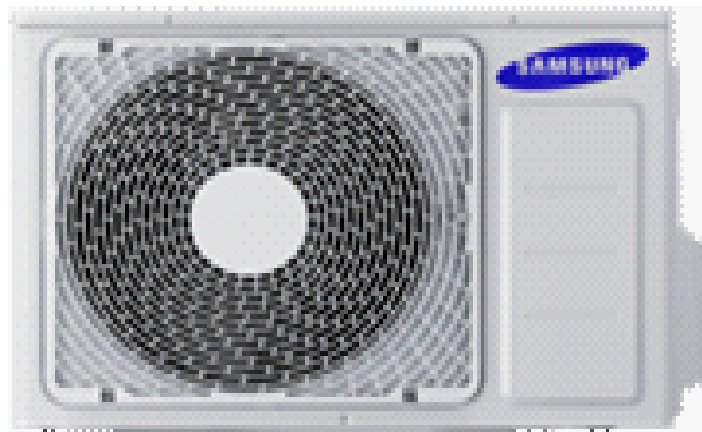

ASV18PSBAXED

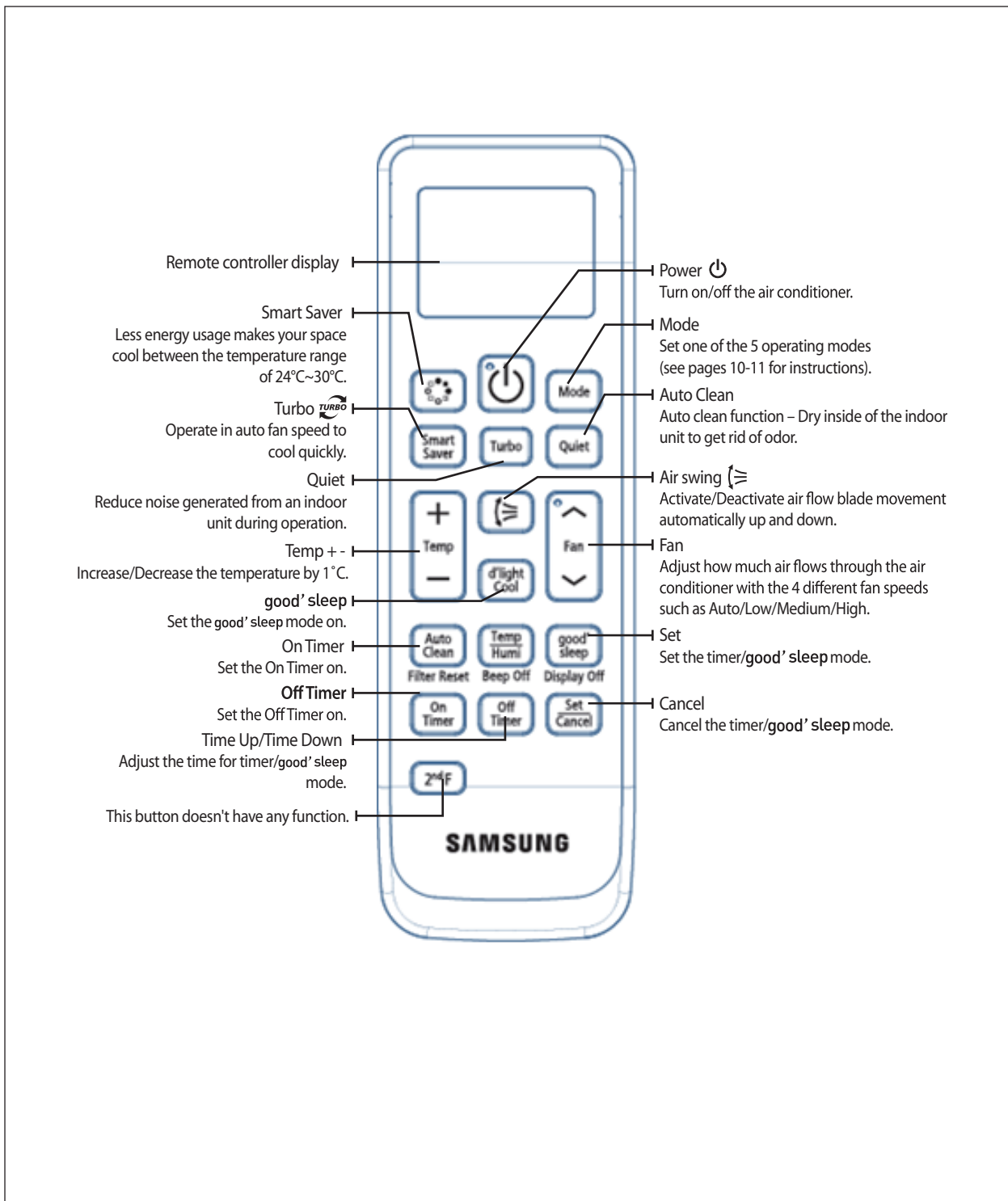

11-2 Wireless Remote Control-Buttons and Display



12. Troubleshooting

12-1 Items to be checked first

- The input voltage should be rating voltage $\pm 10\%$ range.
The air conditioner may not operate properly if the voltage is out of this range.
- Is the link cable linking the indoor unit and the outdoor unit linked properly?
The indoor unit and the outdoor unit shall be linked by 5 cables.
Check the terminals if the indoor unit and outdoor unit are properly linked by the same number of cables.
Otherwise the air conditioner may not operate properly.
- When a problem occurs due to the contents illustrated in the table below it is a symptom not related to the malfunction of the air conditioner.

No	Operation of air conditioner	Explanation
1	The OPERATION indication LED(BLUE) blinks when a power plug of the indoor unit is plugged in for the first time.	It indicates power is on. The LED stops blinking if the operation ON/OFF button on the remote control unit is pushed.
2	In a COOL operation mode, the compressor does not operate at a room temperature higher than the setting temperature that the INDOOR FAN should operate. [In case of heat pump model] In a HEAT operation mode, the compressor does not operate at a room temperature lower than the setting temperature that indoor fan should operate.	In happens after a delay of 3 minutes when the compressor is reoperated. The same phenomenon occurs when a power is on. As a phenomenon that the compressor is reoperated after a delay of 3 minutes, the indoor fan is adjusted automatically with reference to a temperature of the air blew.
3	Fan speed setting is not allowed in DRY() mode.	The speed of the indoor fan is set to LL in DRY mode. Fan speed is selected automatically in AUTO mode.
4	Compressor stops operation intermittently in DRY() mode.	Compressor operation is controlled automatically in DRY mode depending on the room temperature and humidity.
5	Timer LED(ORANGE) of the indoor unit lights up and the air conditioner does not operate.	Timer is being activated and the unit is in ready mode. The unit operates normally if the timer operation is cancelled.
6	The compressor stops intermittently in a COOL mode or DRY mode, and fan speed of the indoor unit decreases.	The compressor stops intermittently or the fan speed of the indoor unit decreases to prevent inside/outside air frozen depending on the inside/outside air temperature.
7	[In case of heat pump model] Compressor of the outdoor unit is operating although it is turned off in a HEAT mode.	When the unit is turned off while de-ice is activated, the compressor continues operation for up to 9 minutes(maximum) until the deice is completed.
8	[In case of heat pump model] The compressor and indoor fan stop intermittently in HEAT mode.	The compressor and indoor fan stop intermittently if room temperature exceeds a setting temperature in order to protect the compressor from overheated air in a HEAT mode.
9	[In case of heat pump model] Indoor fan and outdoor fan stop operation intermittently in a HEAT mode.	The compressor operates in a reverse cycle to remove exterior ice in a HEAT mode, and indoor fan and outdoor fan do not operate intermittently for within 20% of the total heater operation

12-2 Fault Diagnosis by Symptom

Communication error

Outdoor display

●	●	●	lmin. Time out Comm.
○	○	●	Abnormal Communication
○	●	●	

1. Checklist :

- 1) Is the cable between the indoor unit and outdoor unit connected correctly?
- 2) Isn't the power cable and communication cable cross?

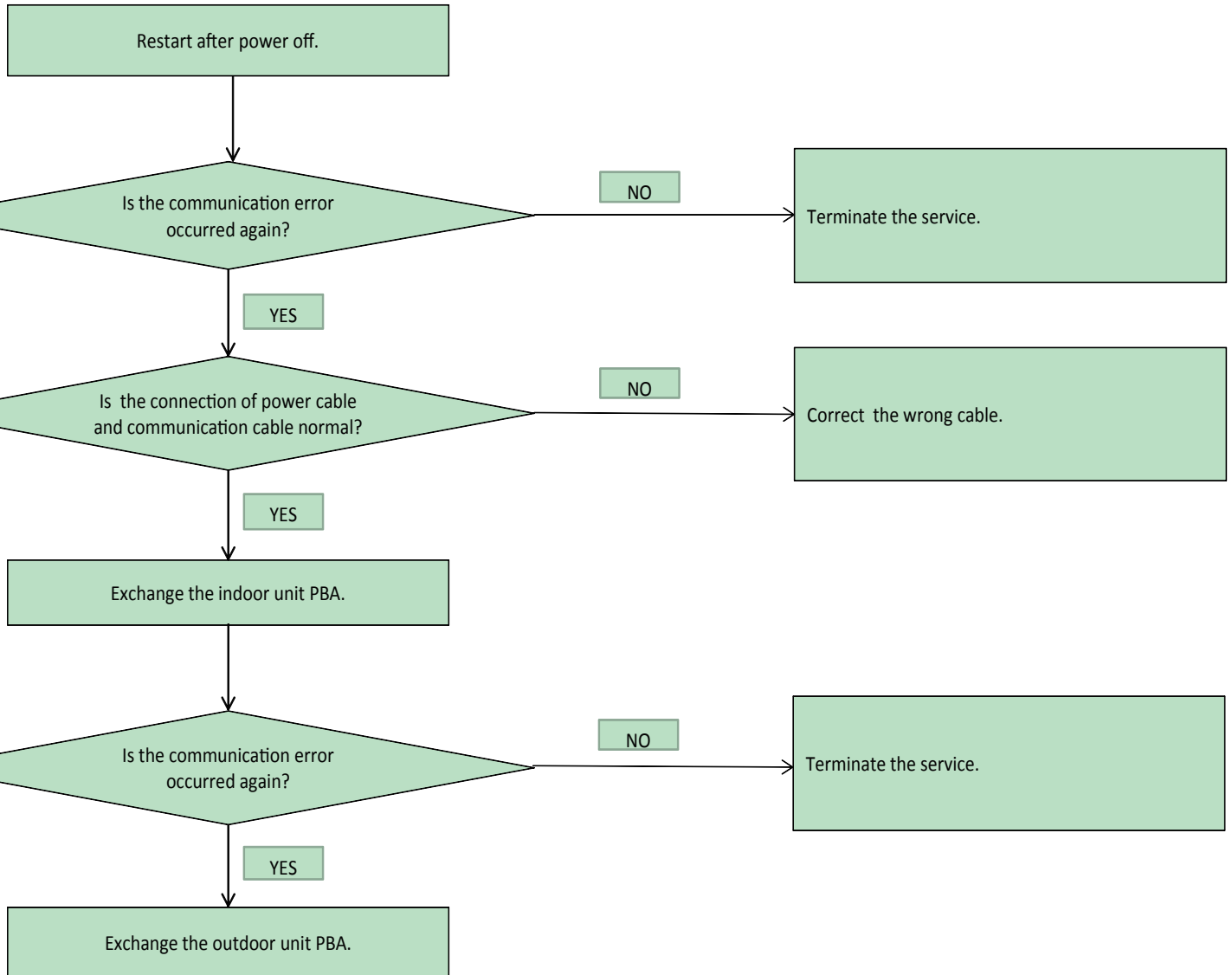

Indoor temperature sensor error

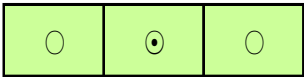
Indoor display  Indoor room temp sensor error

1. Checklist :

- 1) Is the indoor units temperature sensor connected correctly?
- 2) Is the sensor placed correctly?
- 3) Does the both terminal of sensor satisfy the resistance value in accordance with temperature?

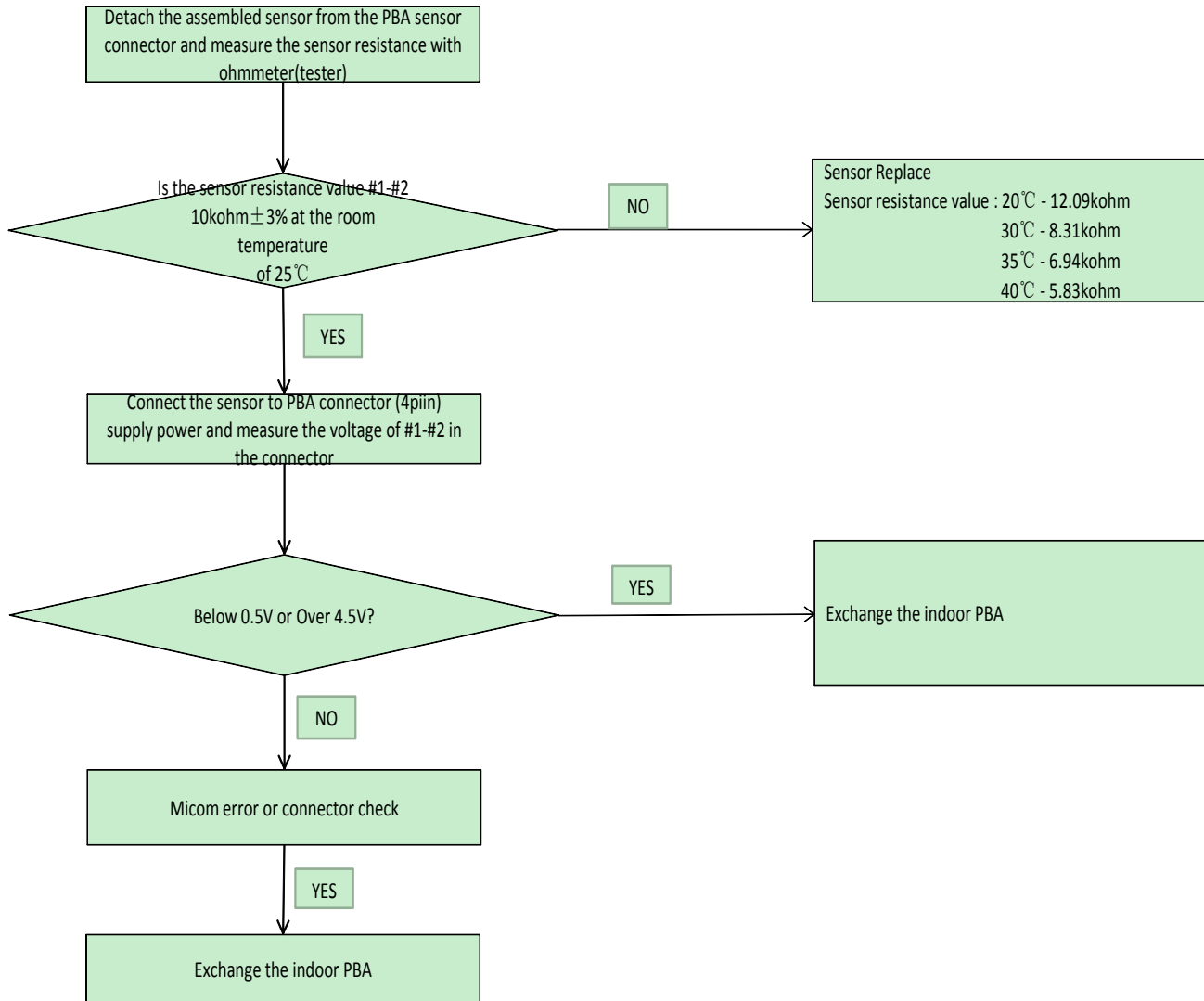

Indoor Eva-in temperature sensor error

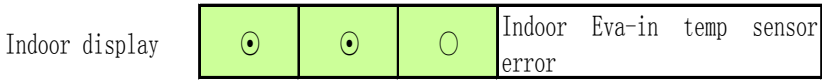

1. Checklist :

- 1) Is the indoor units temperature sensor connected correctly?
- 2) Is the sensor placed correctly?
- 3) Does the both terminal of sensor satisfy the resistance value in accordance with temperature?

2. Troubleshooting procedure

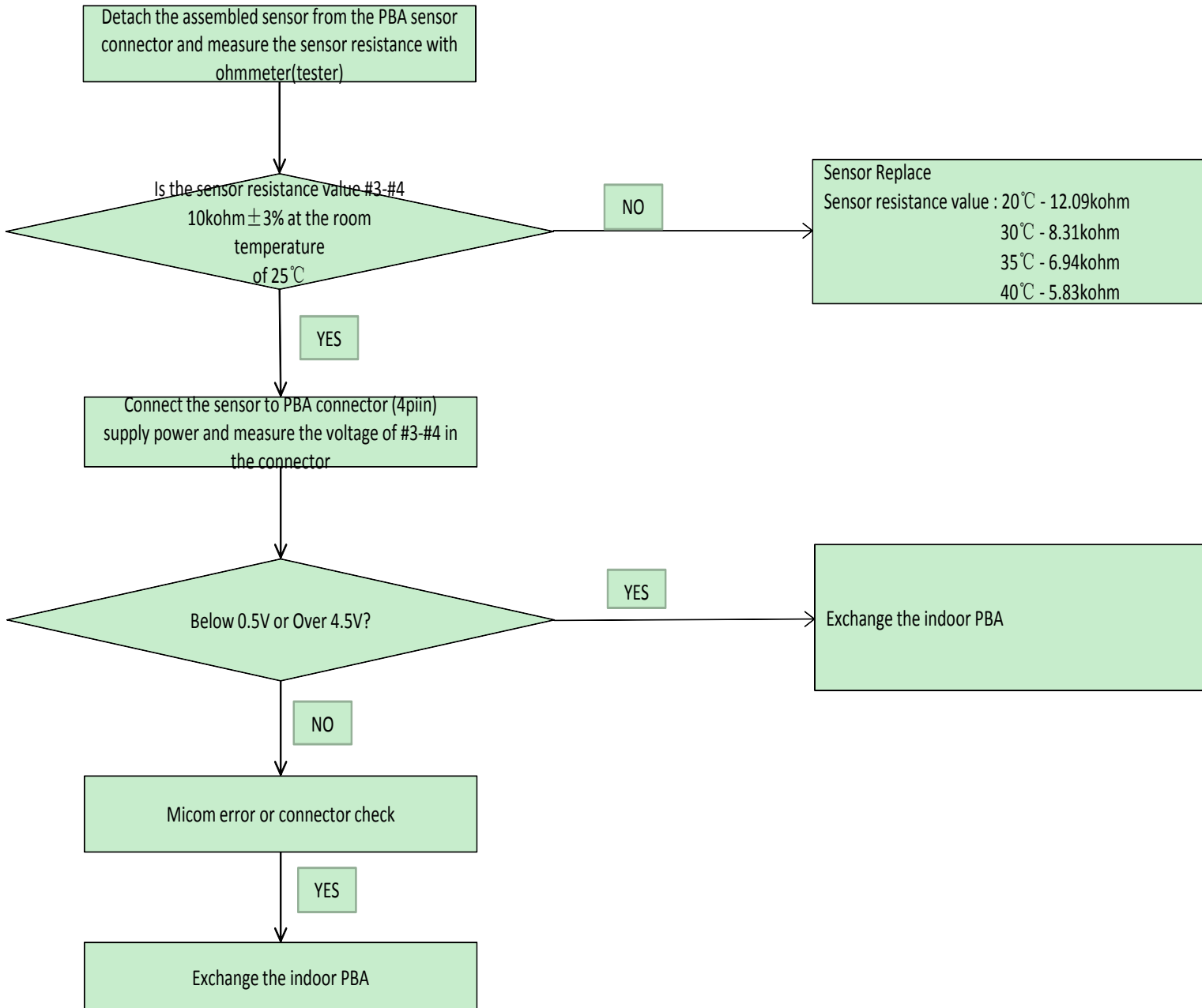

When the Up/Down louver motor does not operate (Initial Diagnosis) (Not displayed)

1. Checklist :

- 1) Is the input power voltage normal?
- 2) Is the Up/Down louver motor properly connected with the connector? (CN61)

2. Troubleshooting procedure

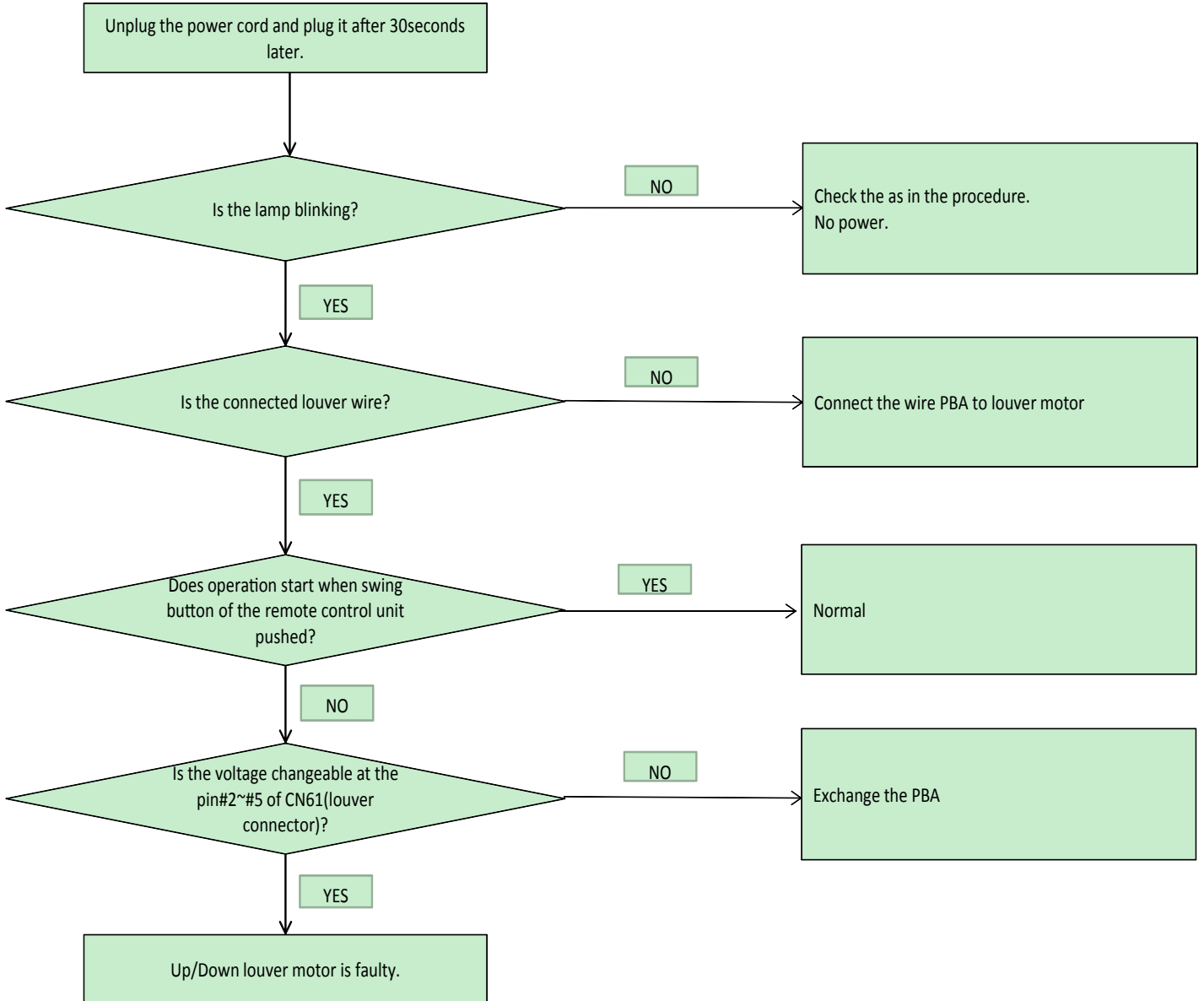

When the remote control is not receiving

1. Checklist :

- 1) Check if the connector was normally assembled.
- 2) Check the battery in remote control
- 3) All the lights out and check again : Change electronic typed to a fluorescent
- 4) Put the set in operation and check the voltage of display PBA
- 5) Replace the display PBA

Indoor fan motor speed detecting error (AC fan)

Indoor display

		●
--	--	---

 Indoor fan error

1. Checklist :

- 1) Is the indoor units fan motor properly connected with the connector(CN72)?
- 2) Is the AC voltage correct?
- 3) Is the HALL IC(feedback sensing) in indoor fan motor properly connected with the connector(CN44)?
- 4) Is the running capacitor(CR71) properly connected with PBA?

2. Troubleshooting procedure

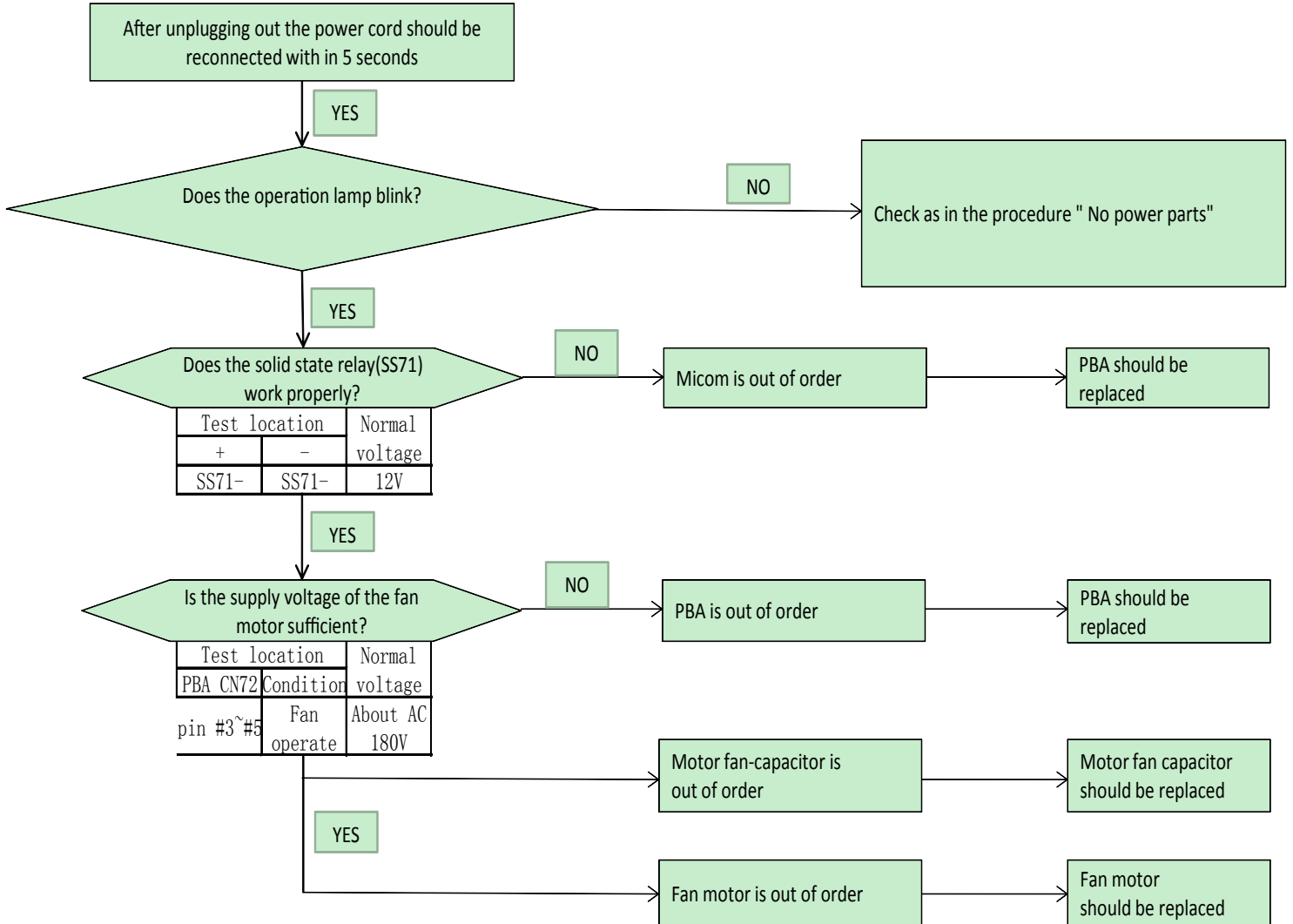

OLP sensor error/OLP over heat

Outdoor display				OLP over heat
				OLP sensor error

1. Checklist :

- 1) Is the sensor connected correctly?
- 2) Is the sensor placed correctly?
- 3) Does the both terminal of sensor satisfy the resistance value in accordance with temperature?
- 4) Is the resistance value of sensor connection pull-up correct?
- 5) Check the compressor locking or gas leak

2. Troubleshooting procedure

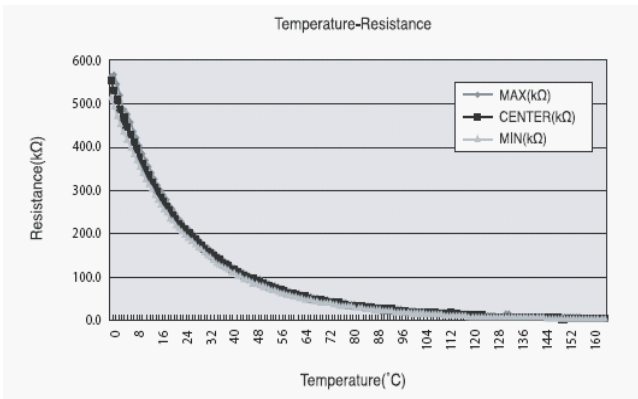
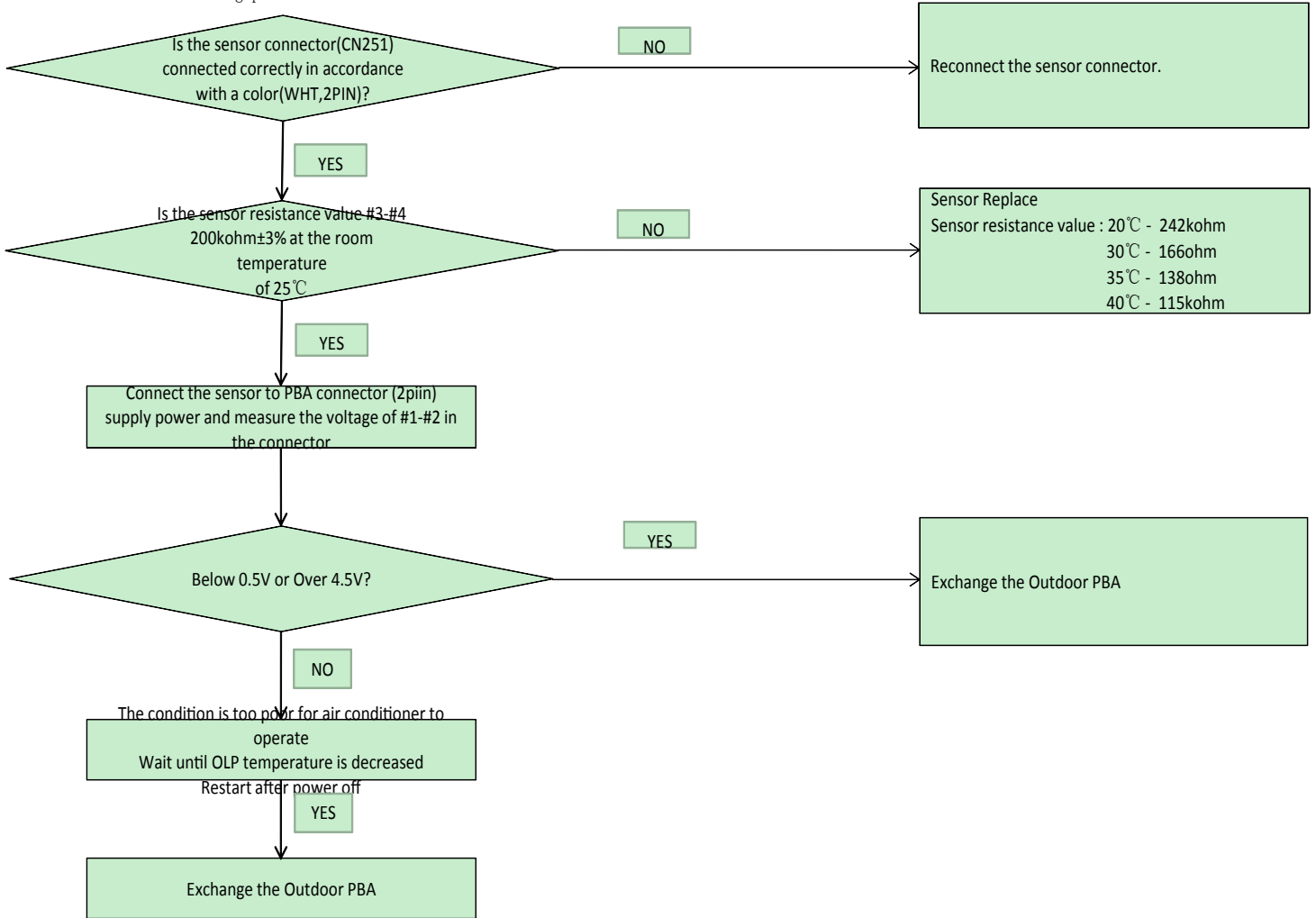

Compressor starting error

Outdoor display    Comp starting error

1. Checklist :

- 1) Is the connection of cable for the compressor?
- 2) Is the compressor wire is connected clockwise? U (RED) -V (BLU) -W (YEL)
- 3) Is the interphase resistance of compressor normal?

2. Troubleshooting procedure

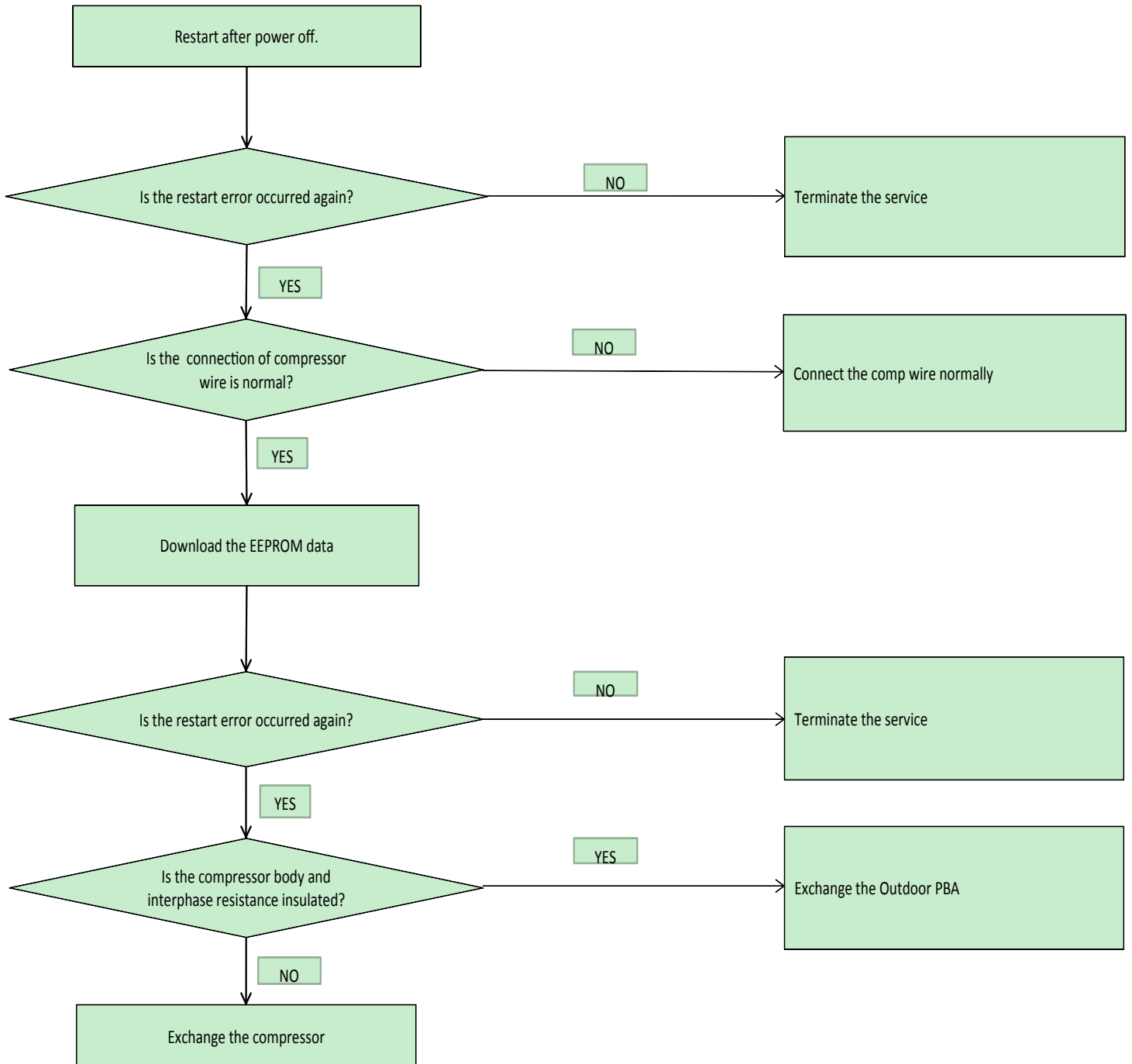

Compressor wire missing error/rotation error

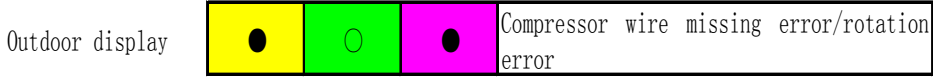

1. Checklist :

- 1) Is the connection of cable for the compressor?
- 2) Is the compressor wire is connected clockwise? U (RED)-V (BLU)-W (YEL)
- 3) Is the interphase resistance of compressor normal?

2. Troubleshooting procedure

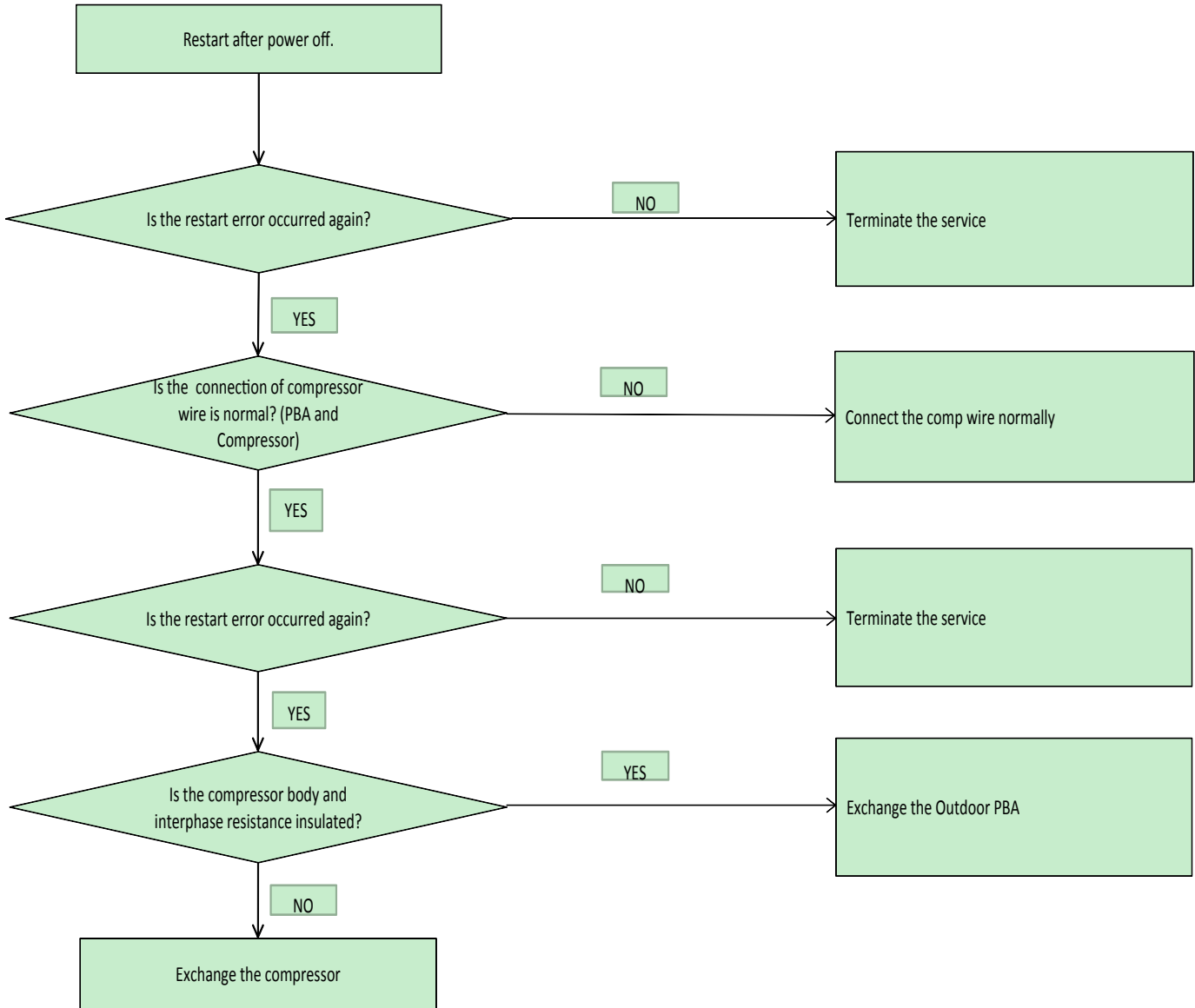

O.C(Over Current) error

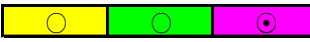
Outdoor display  Comp starting error

1. Checklist :

- 1) Is the IPM Shunt (R451, R452, R453) resistance value correct? Check the resistor is opened
- 2) Is the condition of surrounding temperature abnormal overload?
- 3) Is there any problem as like the temperature sensor separation or measurement value error?
- 4) Is the interphase resistance of compressor normal?

2. Troubleshooting procedure



DC_link voltage sensor error

Outdoor display



1. Checklist :

- 1) Is the input voltage of outdoor terminal block is normal?
- 2) Is the reactor wire connected?
- 3) Is the DC_link capacitor (CE101, CE102, CE103) assembled in accordance the specification? (Outdoor PBA)
- 4) Is the DC_link resistor (R104, R106, R107, R108) value is normal?

2. Troubleshooting procedure

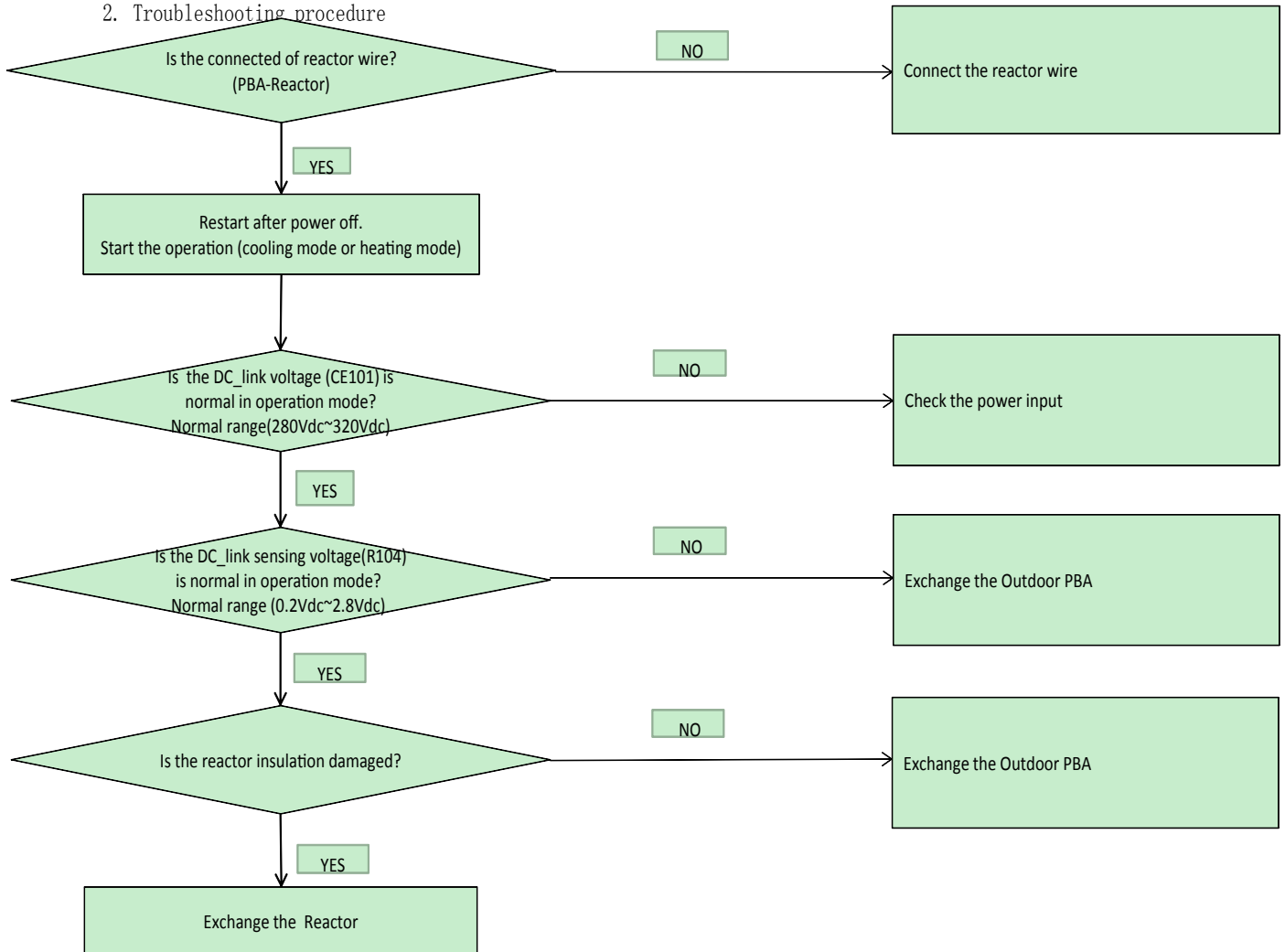

DC_link voltage under/over error, Over voltage protection error/PFC over load

Outdoor display	○	●	⊙	DC_link voltage under/over error Over voltage protection error PFC over load
-----------------	---	---	---	--

1. Checklist :

- 1) Is the input voltage of outdoor terminal block is normal?
- 2) Is the input voltage is higher than 300Vac?
- 3) Is the reactor wire connected?
- 4) Is the DC_link capacitor(CE101, CE102, CE103) assembled in accordance the specification? (Outdoor PBA)
- 5) Is the DC_link resistor(R104, R106, R107, R108) value is normal?

2. Troubleshooting procedure

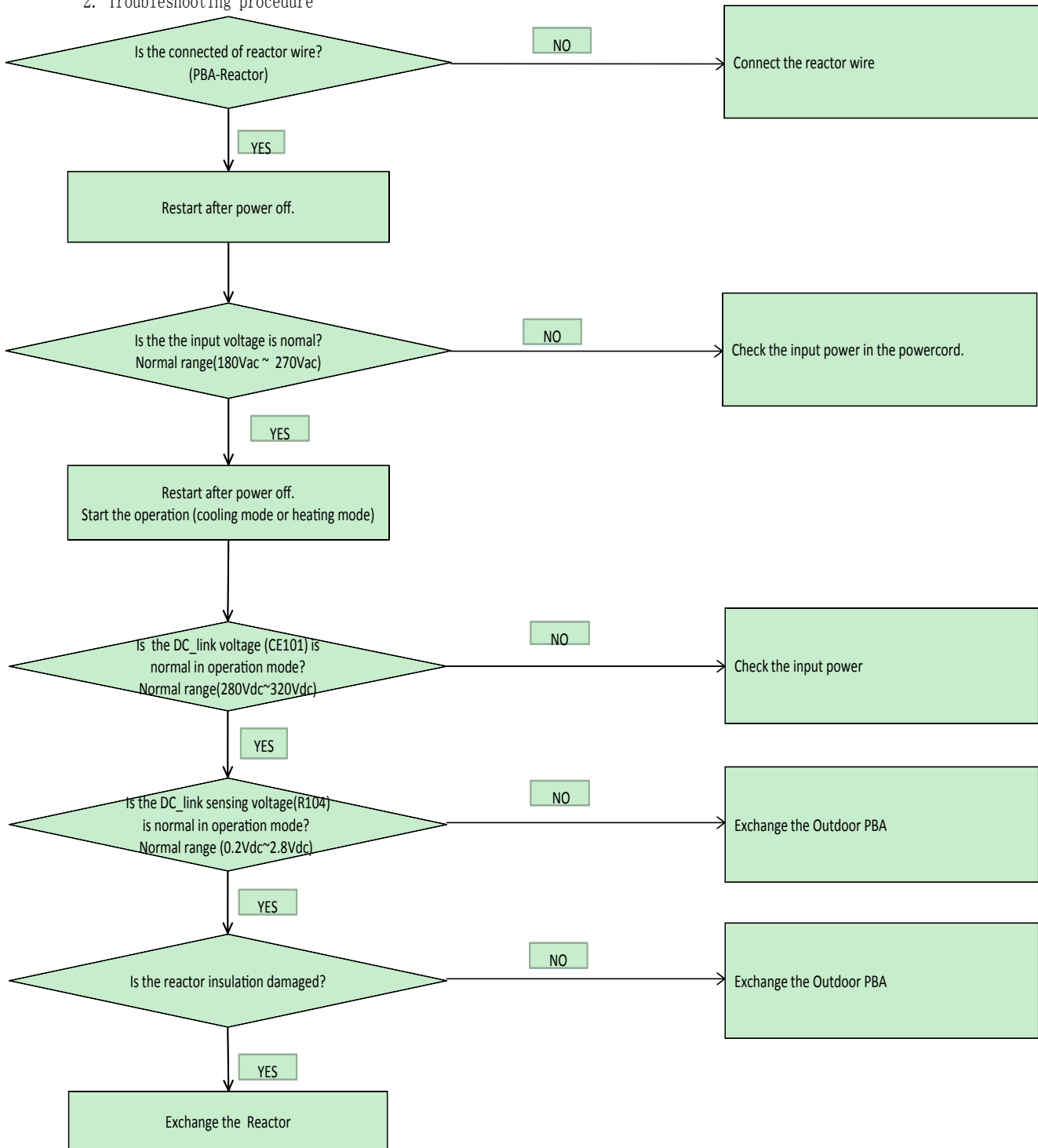

I_trip error, PFC over current

Outdoor display  I_trip error, PFC over current

1. Checklist :

- 1) Is the PFC Shunt(R062, R063) resistance value correct? Check the resistor is opened
- 2) Is the condition of surrounding temperature abnormal overload?
- 3) Is there any problem as like the temperature sensor separation or measurement value error?
- 4) Is the interphase resistance of compressor normal?

2. Troubleshooting procedure

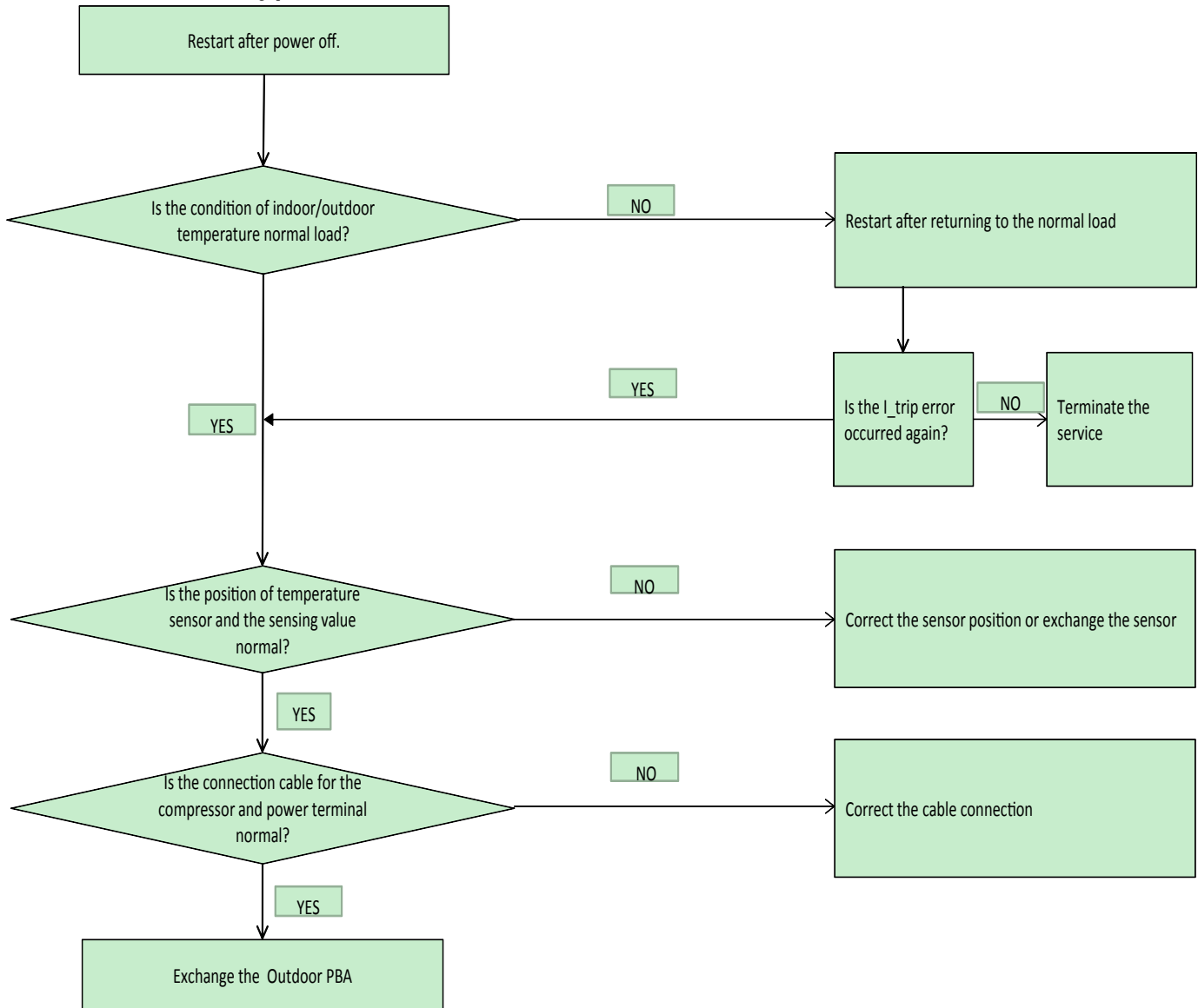

Current sensor error/Input current sensor error

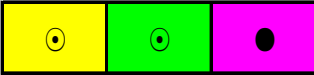
Outdoor display  Current sensor error/Input current sensor error

1. Checklist :

- 1) Is the PFC Shunt (R062, R063) resistance value correct? Check the resistor is opened
- 2) Is the IPM Shunt (R451, R452, R453) resistance value correct? Check the resistor is opened
- 3) Is there no short or open around IC451?

2. Troubleshooting procedure

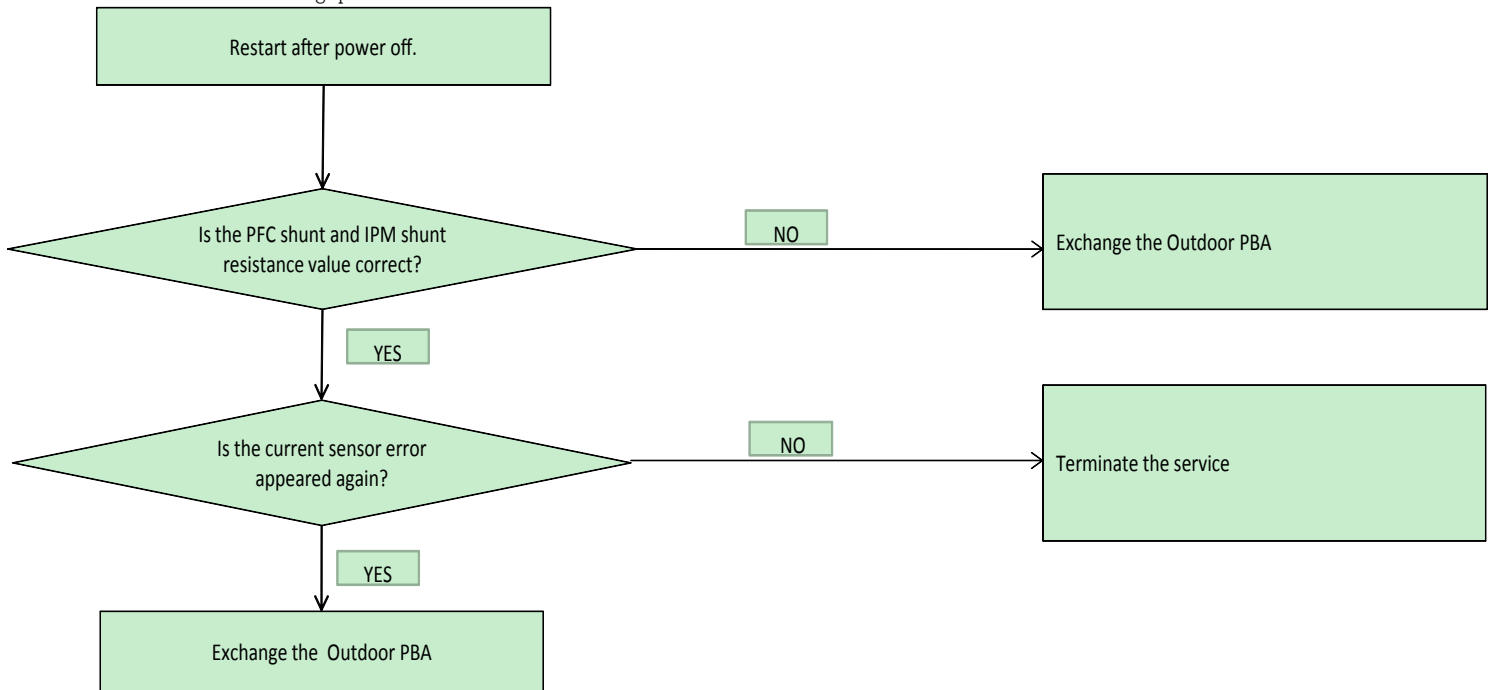

Heatsink sensor error/Heatsink over heat

Outdoor display    Heatsink sensor error/Heatsink over heat

1. Checklist :

- 1) Are there screws assembly in PBA-heatsink?
- 2) Is the gap PBA-heatsink
- 3) Is the fan operation normal?
- 4) Is the cover assembly in control-box normal?

2. Troubleshooting procedure

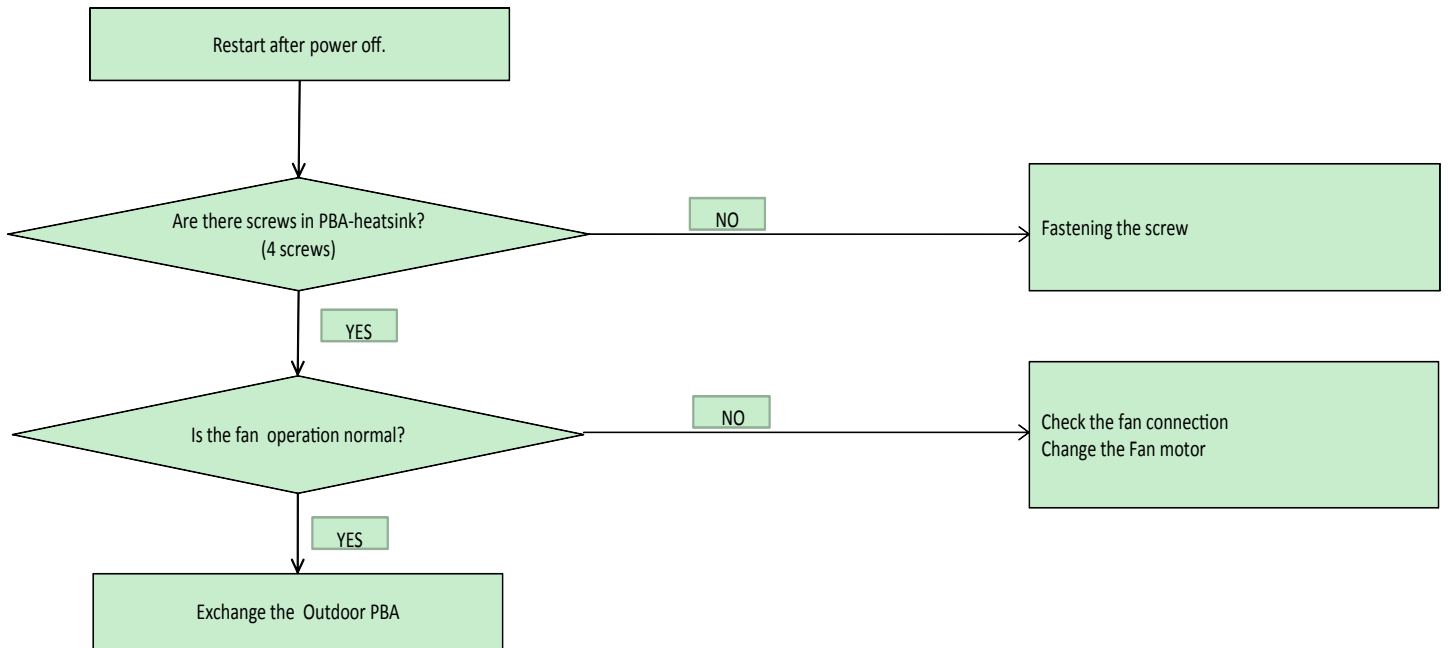

Comp Vlimit error/Comp current limit error

Outdoor display    Comp Vlimit error/Comp current limit error

1. Checklist :







- 1) Is the IPM Shunt (R451, R452, R453) resistance value correct? Check the resistor is opened
- 2) Is the condition of surrounding temperature abnormal overload?
- 3) Is there any problem as like the temperature sensor separation or measurement value error?
- 4) Is the interphase resistance of compressor normal?

2. Troubleshooting procedure



EEPROM error/OTP error

Outdoor display

			EEPROM error
			OTP error

1. Checklist :

- 1) Is there a short around micom?
- 2) Is there a short around IC502?
- 3) Did you download or insert EEPROM IC, after changing outdoor PBA?

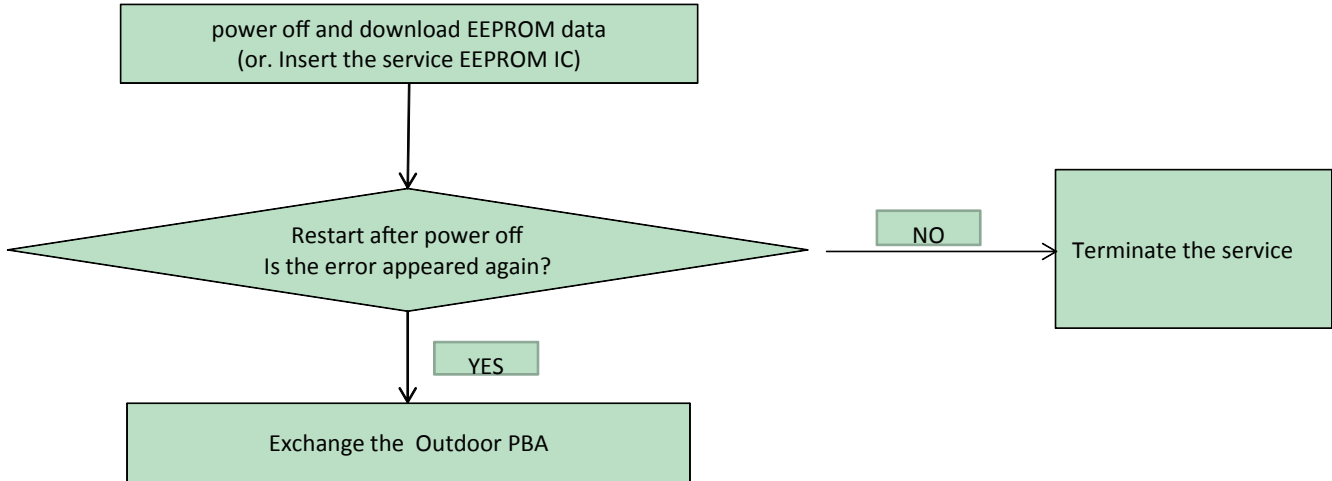

AC zero cross signal error

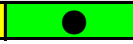
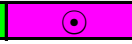
Outdoor display    AC zero cross signal error

1. Checklist :

- 1) Check the power condition at customer's house (Is there any power noise?)
- 2) Have been there power failure?

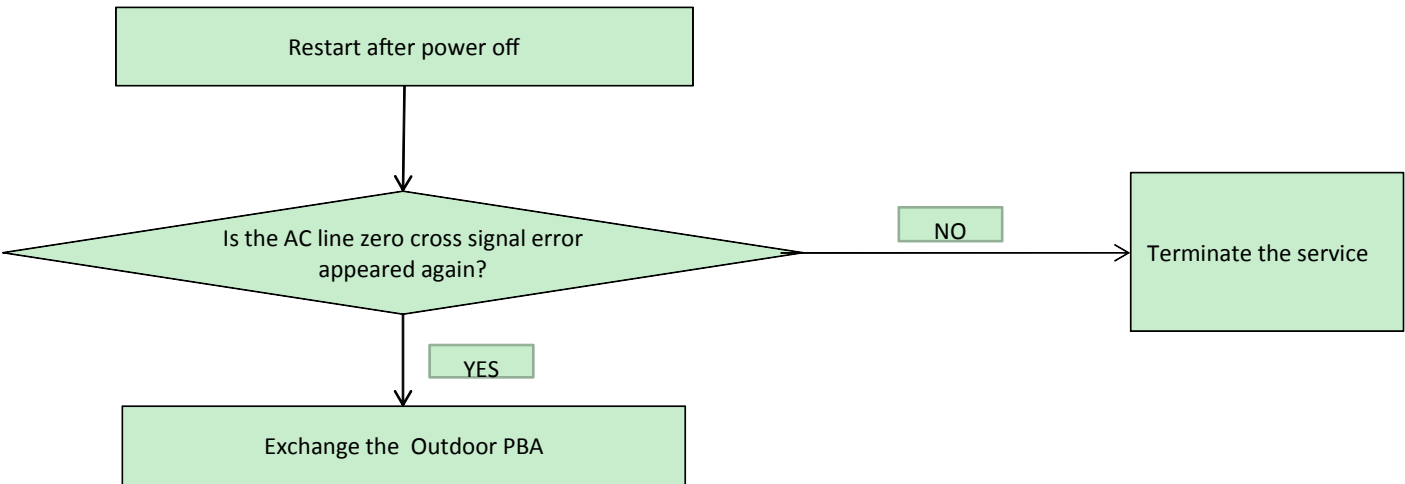

No power indoor (Initial Diagnosis) (Not displayed)

1. Checklist :

- 1) Is input power normal?
- 2) Is AC power linked correctly?
- 3) Is input voltage of DC_link capacitor normal?
- 4) Is the voltage of DC regulator normal?

2. Troubleshooting procedure

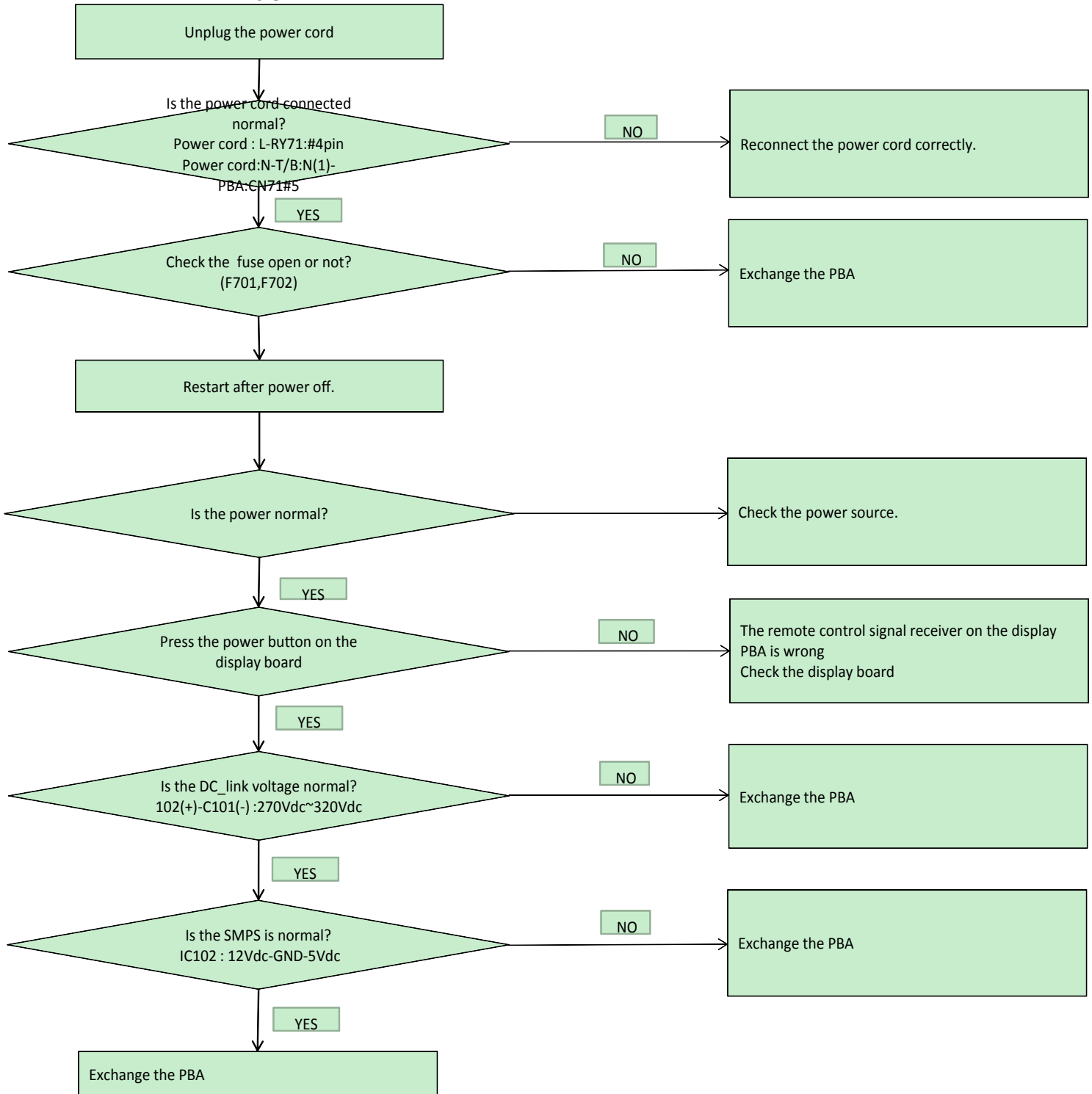

No power outdoor (Initial Diagnosis) (Not displayed)

1. Checklist :

- 1) Is input power normal?
 - 2) Is AC power linked correctly?
 - 3) Is the cable connected correctly between indoor and outdoor unit?
 - 4) Is there AC power in indoor terminal block?
 - 5) Is the cable connected correctly between Terminal block and PBA?
 - 6) Is input voltage of SMPS DC_link capacitor normal?
 - 7) Is the voltage of SMPS normal?
2. Troubleshooting procedure

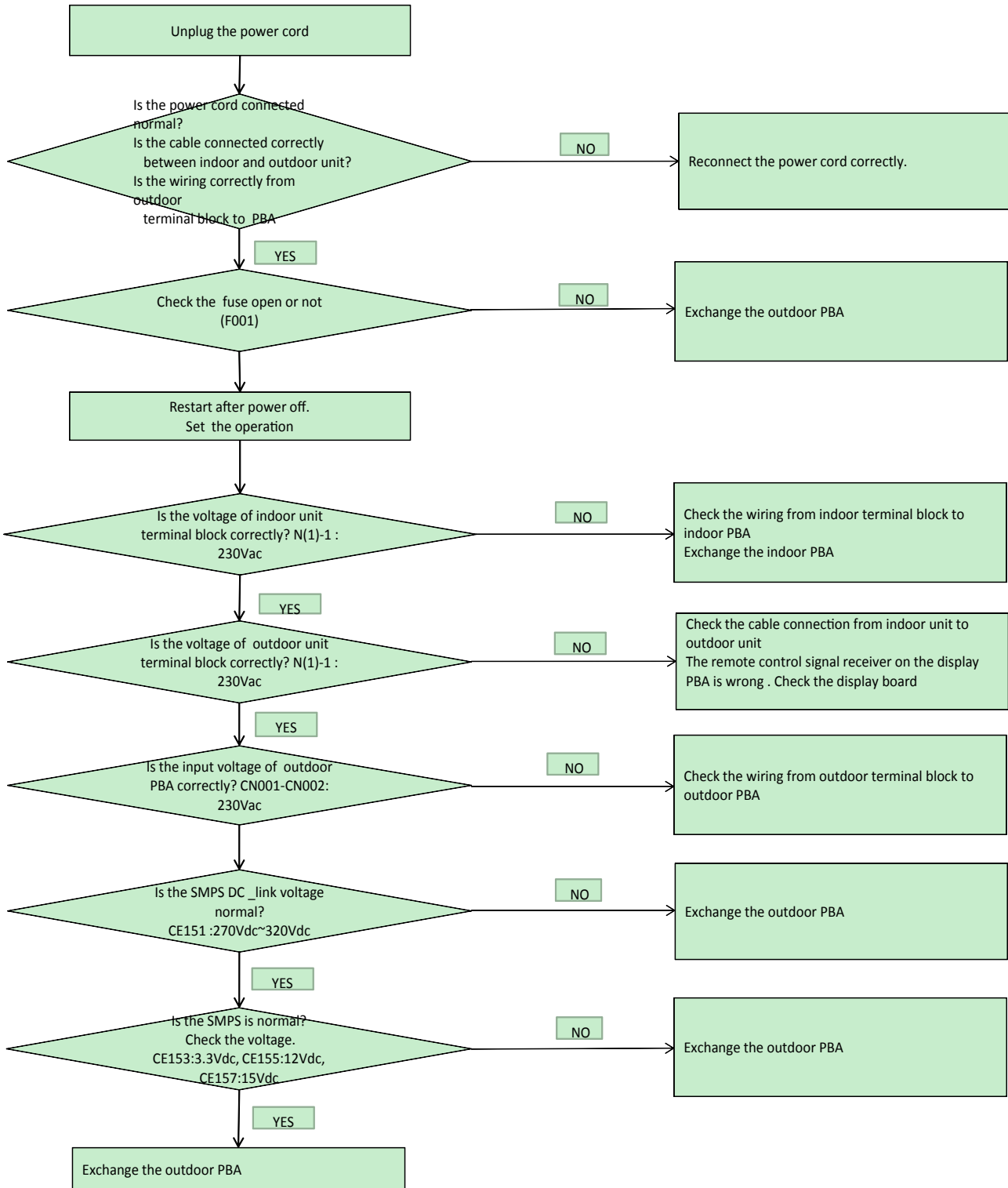

Heatsink sensor error/Heatsink over heat

Indoor display	●	○	●	Outdoor error
Outdoor display	○	●	●	Heatsink sensor error/Heatsink over heat (A**PW**)
	●	●	●	Heatsink sensor error (A**PS**)
	●	●	●	Heatsink over heat (A**PS**)

1. Checklist :

- 1) Are there screws assembly in PBA-heatsink?
- 2) Is the gap PBA-heatsink
- 3) Is the fan operation normal?
- 4) Is the cover assembly in control-box normal?

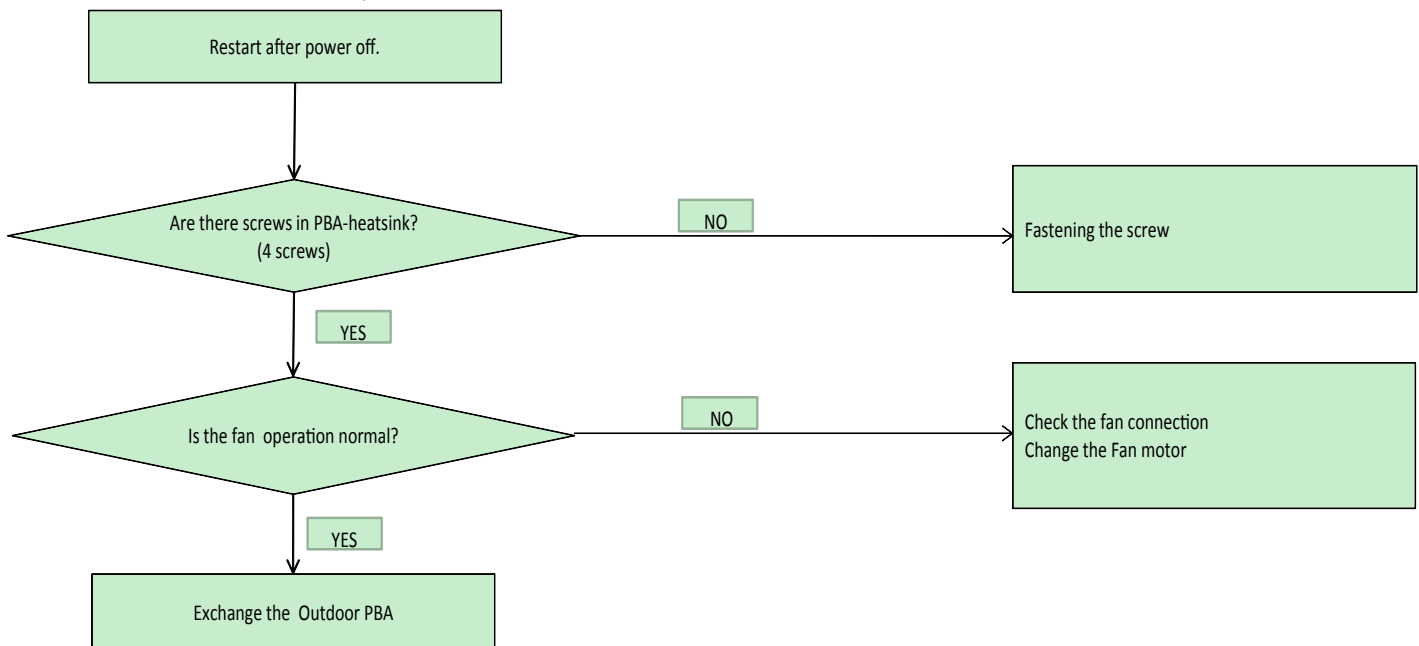

12-3-1 Pre-inspection Notices

1. Check if you pulled out the AC power plug when you eliminate the PCB or front panel
2. Don't hold the PCB side not impose excessive force on it to eliminate the PCB
3. Don't pull the lead wire but hold the whole housing to connect or disconnect a connector to the PCB
4. In case of outdoor PCB disassembly, check first the complete discharge of condenser after 1 minute power off

12-3-2 Inspection procedure

1. Check connector connection and peeling of PCB or bronze coating pattern when you think the PCB is broken
2. The PCB is composed of 3 parts
 - Indoor Main part : MICOM and surrounding circuit, relay, fan motor sensing and driving circuit, temperature sensing circuit power circuit of SMPS, buzzer circuit. Communication circuit
 - Display part : LED lamp, Switch, Remote-control module
 - Outdoor Main part : MICOM and surround circuit, fan motor sensing and driving circuit, compressor driving circuit power circuit of SMPS, PFC control circuit, 4way circuit, communication circuit, OPTION (EEV control circuit, temperature sensing circuit)

12-3-3 Indoor detailed inspection procedure

No	procedure	Inspection Method	Cause
1	Plug out and pull the PCB out of the control box Check the PCB fuse	1) Is 1st fuse disconnected? 2) Is 2nd fuse disconnected?	. Over current . Indoor Fan motor short . AC part and pattern short of Indoor PBA
2	Supply power If the operating lamp twinkles at this time , the above 1)~3) have no relation	Check the power voltage	
		1) Is the BD71 input voltage 200Vac~240Vac?	. Power cord is fault, Fuse open, Wrong Power cable Wiring, AC part is faulty
		2) Is the voltage between both terminal of IC02 pin #1-#2 12Vdc?	. Switching Trans of Power circuit is faulty
3	Press the ON/OFF button 1. Fan speed(high) 2. Continuous Operation	3) Is the voltage between both terminal of IC02 pin #2-#3 5Vdc?	. Power circuit is faulty, Load short
		1) Is the voltage over AC 180V being imposed on terminal #3-#5 of fan motor connector (CN72)?	. Fan motor of the indoor is faulty
		2) The fan motor of the indoor unit doesn't run	. Fan motor connector(CN72) is faulty
		3) The power voltage between terminal #3-#5 of the connector(CN72) is 0V	. PBA is faulty

12-3-4 Outdoor detailed inspection procedure

No	procedure	Inspection Method	Cause
1	Plug out and pull the PCB out of the control box Check the PCB fuse (Wait 3 minutes after power off)	1) Is 1st fuse disconnected? 2) Is indoor PBA faulty?	. Over current . AC part and pattern short of Indoor PBA . AC part and pattern short of Outdoor PBA
2	Check the Wiring	1) Is the Compressor wire connected clockwise? 2) Is the Reactor wire connected normal? 3) Is the Fan wire connected normal? 4) Is the 4way wire connected normal? 5) Is the sensor wire connected	. Wrong assembly . Installation(service) condition is bad
3	Supply power and operate the set (Use Remote-control, button in indoor set)	Check the power voltage	
		1) Is the voltage between Terminal block N(1)-1 200Vac~240Vac?	. Power cord is faulty, Indoor PBA fault, Wrong Power cable Wiring
		2) Is the PFC050(#26-#27) input voltage 200Vac~240Vac?	. L,N,E wire wrong wiring (Terminal Block-PBA) . Fuse open . PTC020 open . RY021, RY022 is faulty . Outdoor Micom(IC151) error
		3) Is the CE151 voltage 280Vdc~320dc?	. Power circuit is faulty . Load short
		3) Is the CE101 voltage 280Vdc~320dc?	. PFC050 is faulty . Reactor wire is wrong connection
		4) Is the voltage CE157 voltage 15Vdc?	. Switching Trans of Power circuit is faulty
		5) Is the voltage CE155 voltage 12Vdc?	. Switching Trans of Power circuit is faulty
4	Check the LED lamp display	6) Is the voltage CE153 voltage 3.3Vdc?	. Switching Trans of Power circuit is faulty . Load short
		1) Normal : RED on, GRN blink, YEL off 2) Abnormal - All off : check no power - abnormal display : check error mode	. L,N,C wire wrong wiring . Outdoor PBA is faulty

12-4 Main Part Inspection Method

Part	Breakdown Inspection Method			
Room Temperature Sensor	Measure resistance with a tester			
	Normal	At the normal temperature 37kΩ~ 8.3kΩ(-7°C~+30°C)		
	Abnormal	∞, 0Ω . . . Open or Short		
Room Fan Motor	Measure the resistance between terminals of the connector (CN72) with a tester.			
	Normal	At the normal temperature (10°C ~ 30°C)		
		Compare terminal	Resistance	Remark
		Yellow, Blue	404.4Ω ± 10%	Main
Yellow, Red	340Ω ± 10%	Sub		
Abnormal	∞, 0Ω . . . Open or Short			
Stepping Motor	Measure the resistance between the red wire and each terminal wire with a tester.			
	Normal	About 300Ω at the normal temperature (20°C ~ 30°C)		
	Abnormal	∞, 0Ω . . . Open or Short		

13. Block Diagram

13-1 Indoor Unit

* : OPTION

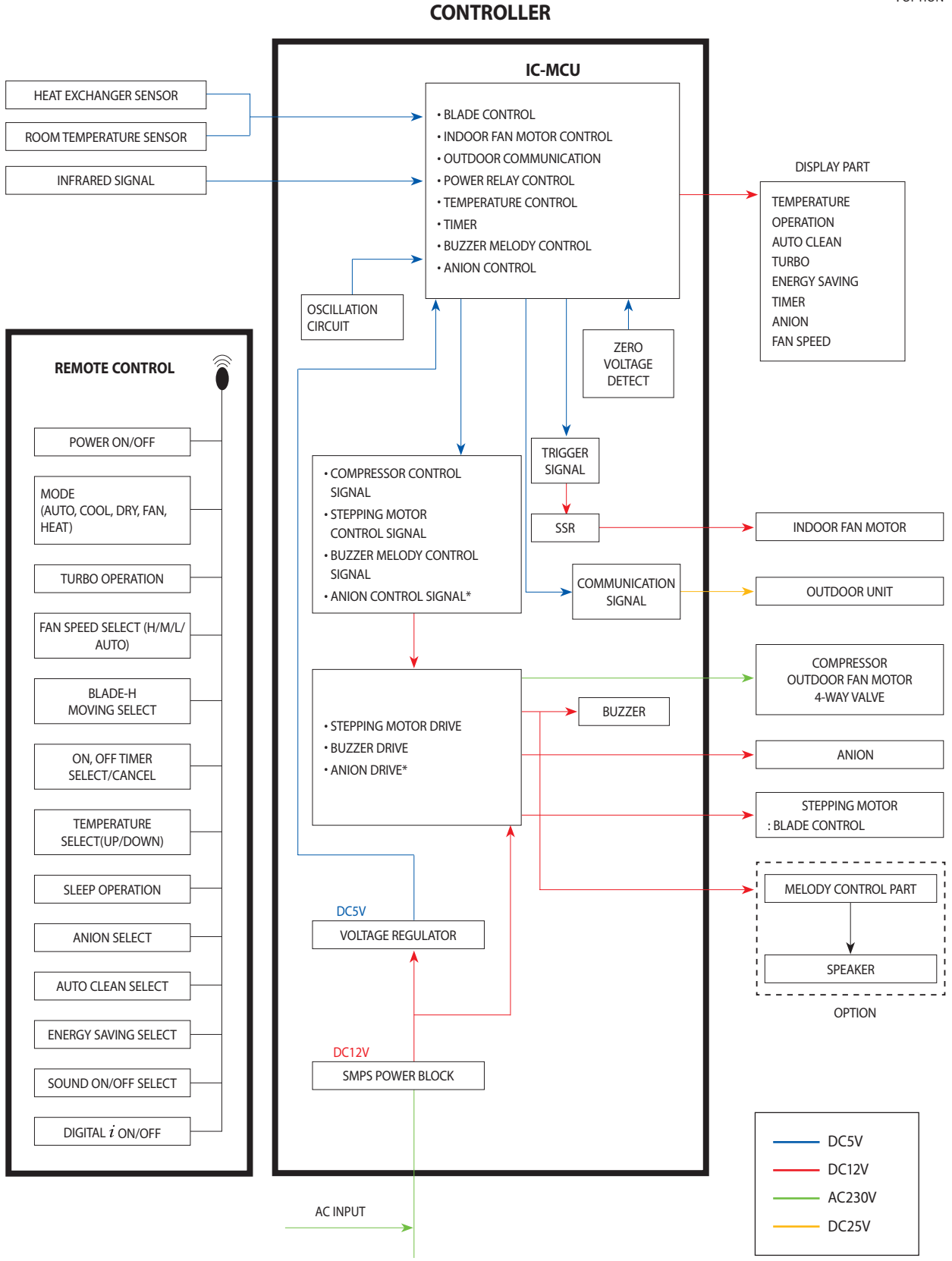

13-2 Outdoor Unit

ASV09PSBAXED/ASV12PSBBXED

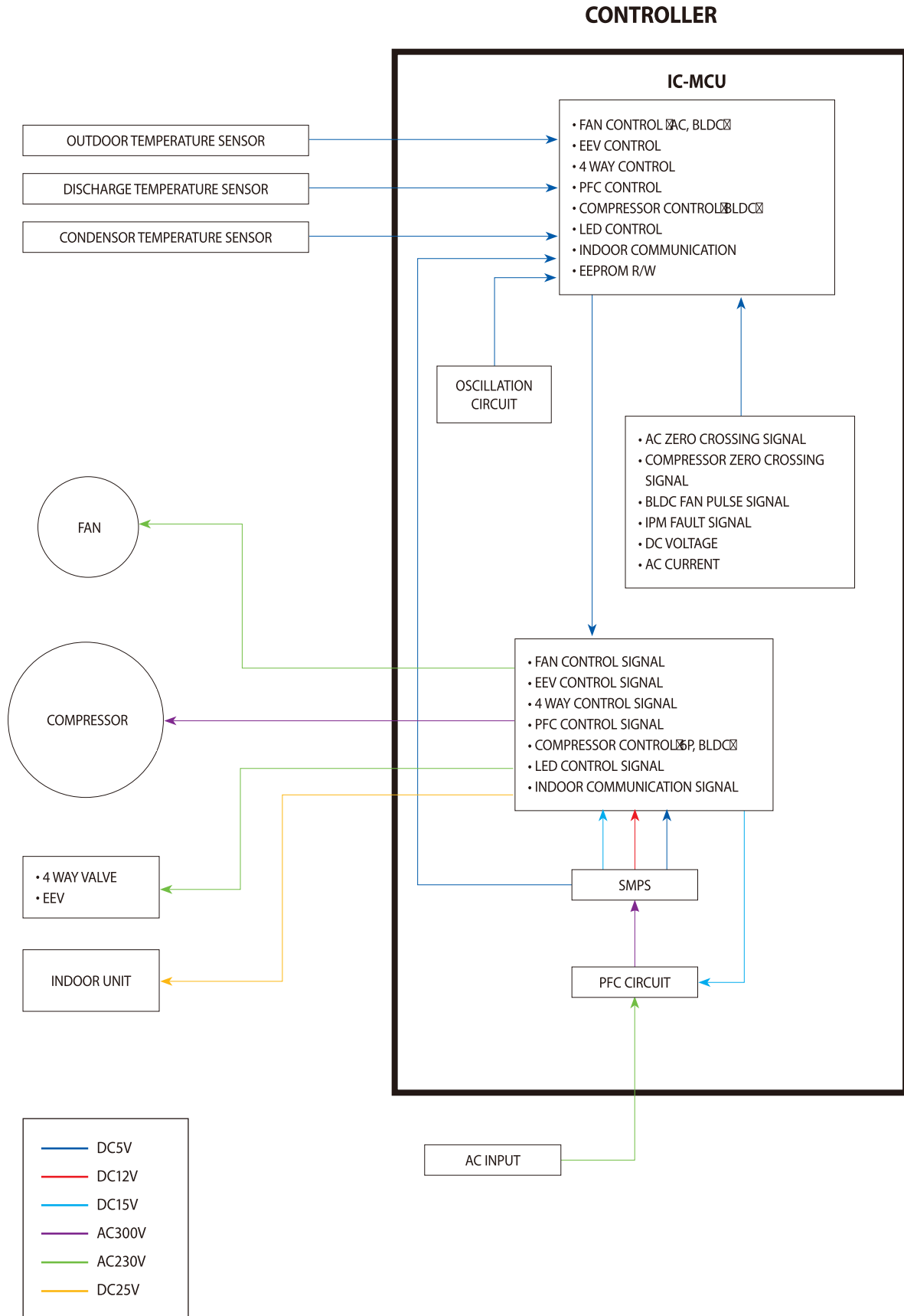

13-2 Outdoor Unit

ASV18PSBAXED

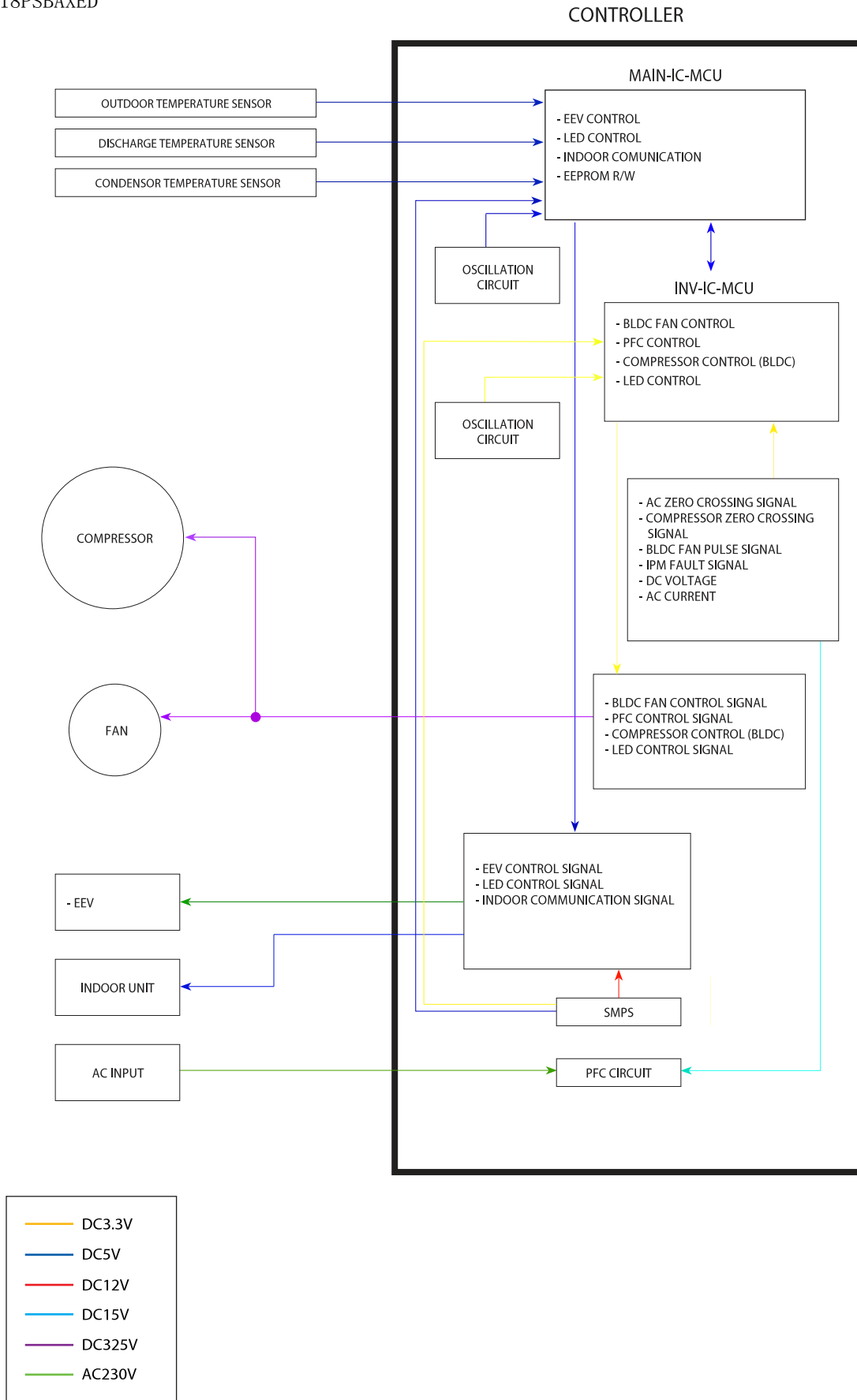

14. Reference Sheet

14-1 Index for Model Name

* Project model code for overseas from 2007(For RAC Export Models)

Model Code

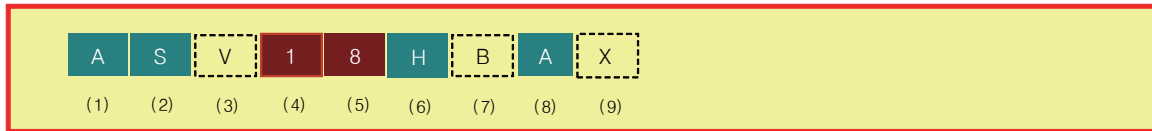

Ex.) Maldives (Grille - White) Heat Pump12k Btu/h Model Indoor Unit

A Q V 1 2 P W A N

(1), (2) Product Division	
AS	Cooling Only
AQ	Heat Pump

(3) Inverter	
V	Inverter
None	Non Inverter

(4), (5) Capacity	
09	9,000 Btu
12	12,000 Btu
18	18,000 Btu
24	24,000 Btu

(6) Project	
A	Mont Blanc (Premium)
B	Crystal - Temporary
C	Max (including Smart) - Temporary
D	Mont Blanc (Deluxe)
E	Crystal (Vivaldi Deluxe)
F	Forte
G	GP
H	HB
J	WW Premium
K	Jungfrau-PRM
L	Forte Deluxe
M	Moderato
N	Neo Forte
P	Maldives
R	Max Smart (Vivaldi Std)
S	Forte Smart (SSEC)
T	Boracay
U	Max (Vivaldi Standard)
V	Vivace
W	WW
X	Forte Smart (TSE)
Y	Jungfrau-DLX

(7) Grille Color	
B	Black
S	Silver
W	White
F	La Fleur
U	Blue
G	Grey

(8) Version	
A-K	SSEC
L-S	TSE

(9) Unit	
N	Indoor Unit
X	Outdoor unit

● Except the RAC Export Models for China.

14-2 Low Refrigerant Pressure Distribution

Note : • Please measure the refrigerant pressure after the air conditioner operates on testing cooling mode during more than 10 minutes.

- Indoor Temp. Variation : 20°C ~ 32°C
- Outdoor Temp. Variation : -5°C ~ 45°C

Low Refrigerant Pressure Distribution

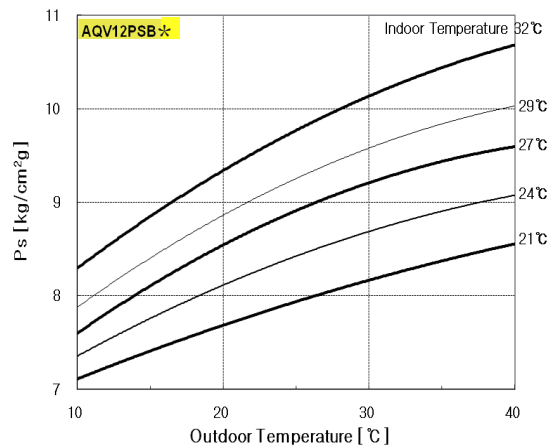
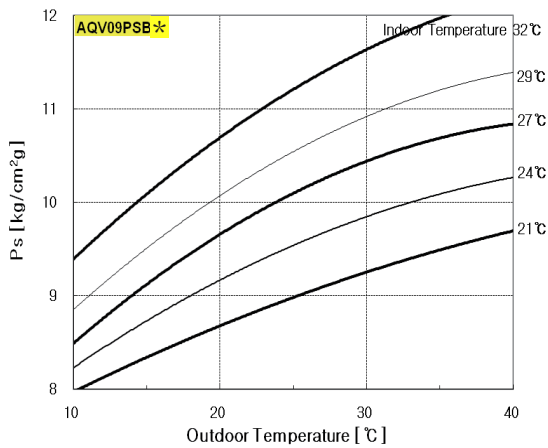
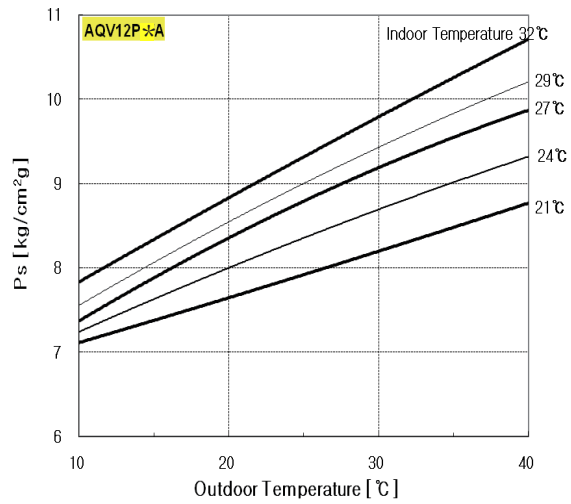
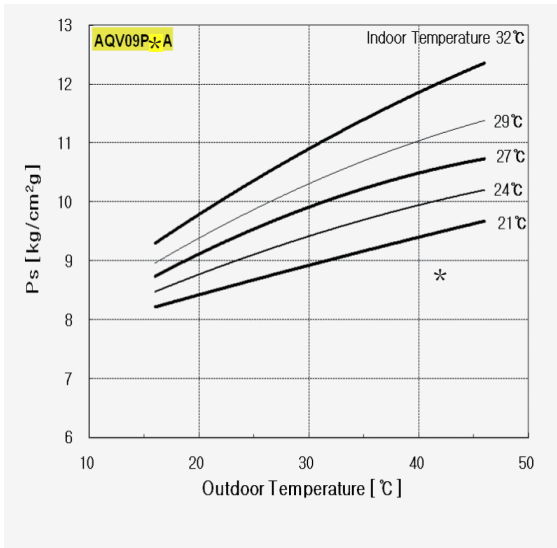

Outdoor Temperature [°C]

14-3 Pressure & Capacity mark

■ Power/Heat

W	cal/s	kcal/h	Btu/h	HP	kg·m/s	lb·m/s
1	0.23885	0.85985	3.4121	0.001341	0.10197	0.73756
4.1868	1	3.6	14.286	0.0056146	0.42693	3.088
1.163	0.27778	1	3.9683	0.0015596	0.11859	0.85778
0.29307	0.06999	0.252	1	3.9302×10^{-4}	0.029885	0.21616
745.7	178.11	641.19	2,544.4	1	76.04	550
9.8067	2.3423	8.4322	33.462	0.013151	1	7.233
1.3558	0.32383	1.1658	4.6262	0.0018182	0.13826	1

14-4 Q & A for Non-trouble

Classification	Class	Description
Cooling	Q	The cooling is weak.
	A	When it is hot outside, its cooling capacity decreases due to the increase of the ambient temperature. When the dust filter gets blocked or warm outside air gets in, the cooling capacity will decrease. So, make sure to clean the dust filter frequently, prevent heat loss by closing the doors and insulate the cooling area by using curtains, blinds, shades or window tinting.
	Q	The cooling is good generally. But, it gets weak when it is considerably hot.
	A	It occurs when the outdoor unit is exposed to direct sun light and heat-up air is not ventilated well. So, set up a sunblind over the outdoor unit and keep stuff away from the unit to increase the ventilation. When the cooling capacity decreases during a heat wave, clean the heat exchanger of the outdoor unit or spray some cold water to the heat exchanger to increase the cooling capability.
	Q	The cooling is weak. Does it need refrigerant charging?
	A	It is not correct charging refrigerant regularly. Except that you have moved in several times or the connection pipes are broken, the refrigerant does not run low. So, when refrigerant is additionally charged, it could be costly and cause a product's failure. When the refrigerant leaks, all of it will escape in a short time resulting in cooling failure and no water coming out of the drain hose. So, if water comes out from the drain hose, it indicates the normal operation of the product and it does not need refrigerant charging.
	Q	It fails to do cooling.
	A	When the air conditioner is set to Ventilation or the desired temperature is set higher than the current temperature, it fails to do cooling. In this case, select Cooling or set the desired temperature lower.
Leakage	Q	It floods the floor.
	A	Place the drain hose properly. When it is not placed properly, the drain water would flow back flooding the floor. So, straighten out the drain hose for the water to be drained well.
	Q	Water drips at the drain connection (service valve) of the outdoor unit.
	A	When a glass bottle is taken out of the refrigerator, moisture gets condensed on its surface due to the temperature differences. The same principle applies to the air conditioner. When cold refrigerant goes through the copper tube, moisture gets condensed on the surface of the tube and the connection areas. To prevent the water condensation, the pipes are insulated. But, the connection areas of the outdoor unit are not insulated for the purpose of maintenance or repair, and water gets condensed due to the temperature differences and drips down. Generally, it evaporates right away. But, when it drips much during muggy days, put a water pan on the floor.
	Q	It leaks even though a drain pump is used.
	A	It occurs when the drain pump is plugged out or it is out of order. Check the power of the drain pump and the position of the drain hose, and when the pump is faulty, contact the drain pump manufacturer. Samsung Electronics do not manufacture drain pumps. So, we are not able to correct the drain pump problems.
Smells	Q	Whenever the air conditioner is turned on, it irritates my eyes and gives me a headache.
	A	There are no components in the air conditioner irritating the eyes and sending out chemical smells. But, when the air conditioner is turned on, other smell sources are sucked into the air conditioner and get out of it. So, find and root out the smell sources. Generally, it occurs at a interior renovated place, a pharmacy, a gasoline handling place, a tire shop, a second-hand book shop or an electronic component handling place; when its chemical or musty smells are sucked in and sent out, it can be misled that the air conditioner generates them. So, find and root out the problem or refresh the room frequently.

Classification	Class	Description
Smells	Q	Whenever the air conditioner is turned on, it stinks.
	A	There are no components in the air conditioner sending out chemical smells. But, when the air conditioner is turned on, other smell sources are sucked into the air conditioner and get out of it. So, find and root out the smell sources. Generally, when the drain hose is taken out to the washing room or there are sources of smells such as a diaper bin, a shoe shelf or a socks bin, bad smells generate. Also, it occurs where glass cleaners or air fresheners are used; when they are sucked in interacting with dusts and moistures inside, bad smells generate. These kinds of organic materials noxious to human bodies. So, we recommend against the use of them.
	Q	Whenever the air conditioner is turned on, it smells sour.
	A	When the room is papered recently, its paste smells would be sucked inside. Also, when the air conditioner is installed in the study room of young boys loving sweat-generating activities such as the basketball, excessive sweats evaporate and get sucked into the air conditioner resulting in bad smells. So, find and root out the problem or refresh the room frequently.
	Q	Whenever the air conditioner is turned on, it smells musty.
	A	It is due to the improper keeping of the product after its use. When keeping the product, dry up the inside with the operation of Ventilation to prevent must. When the product is kept without drying up the inside with Ventilation, mold would grow inside resulting in must. So, open the windows and switch on the Ventilation function to get rid of the saturated smell inside.
	Q	Whenever the air conditioner is turned on, it sends out bad smells such as stale smells.
	A	It occurs generally when there are pet animals in the house. Their smells stay at the same place. But, when the air conditioner is turned on, the air gets circulated resulting in the circulation of the smells. So, find and root out the problem or refresh the room frequently.
	Q	It sends out bad smells.
A	When the air filter is filthy, it could send out bad smells. So, clean the filter and ventilate the room with the windows open while operating the Ventilation function.	
Operation	Q	It won't start.
	A	There is a power failure or it is plugged out. Also, check if the power distribution panel is switched off.
	Q	It goes off during operation.
	A	When the hot air does not escape properly, it goes off during operation. It occurs when it does not ventilate properly because the outdoor unit is covered, the back of the outdoor unit is blocked by a cardboard or a plywood panel, and the front of the outdoor unit is blocked by the closed window or other obstacles. Clear the above obstacles from the outdoor unit.
	Q	It generally works properly. But, when it's considerably hot, it goes off during operation.
	A	It occurs when the outdoor unit is exposed to direct sunlight and the hot air does not escape properly. Set up a sun blind over the outdoor unit and clear the neighboring obstacles from the outdoor unit to provide good ventilation. When it goes off frequently during a heat wave, it would prevent the turn-off and increase the cooling capacity cleaning the outdoor unit or spraying some water to the heat exchanger.
Q	The remote controller won't operate.	
A	When the batteries run out or the transmitter or receiver of the remote controller is blocked by obstacles, change the batteries or keep the obstacles away from the controlling area. Also, the remote controller may not work under intensive light from a 3-wave length lamp or a neon sign due to the EMI. In this case, take the remote controller closer to the receiver.	

Classification	Class	Description
Installation	Q	Who installs the air conditioner? (Relocation/Re-installation)
	A	When relocating or re-installing the air conditioner, make sure to contact Samsung Electronics Service Center or Authorized Service Agent and have them to do the job. (If not, it could cause personal injury or product damage.) The cost for the relocation/re-installation of the air conditioner is subject to the customer's expense. There is a cost table. But, our service engineer needs to visit to total up the cost correctly. When you move in, make sure to contact Samsung Electronics Service Center or Authorized Service Agent in advance to streamline the process.
	Q	Is it possible to install the outdoor unit outside?
	A	It is possible to install it at a designated place in the apartment or on the rooftop nearby. But, it's illegal hanging an angle iron case with the outdoor unit in it outside the apartment. Also, it is illegal obstructing passers-by with the outdoor unit installed outside.
	Q	What can be done to install the outdoor unit facing the road because it is a commercial building?
	A	The following is an excerpt from Building Code going into effect from JUNE 1st 2005. "The exhaust pipe of a cooling or ventilation facility installed in a building adjacent to the streets of commercial or residential areas shall be installed higher than 2 m to prevent the exhaust air from blowing directly to passers-by and the current facilities shall be corrected by MAY 31st 2005." So, please install it higher than 2 m or not to blow the hot exhausting air directly to passers-by.
	Q	What about installing a windscreen during installation not to blow hot air directly to passers-by?
A	When the hot air from the front of the outdoor unit is blocked, the product's performance will be affected and it will fail to operate properly. So, keep it at least 300mm away from its surrounding walls and give it good ventilation.	

14-5 Cleaning/Filter Change

14-5-1 Cleaning your Air Conditioner

To get the best possible use out of your air conditioner, you must clean it regularly to remove the dust that accumulates on the air filter.



- Before cleaning your air conditioner, ensure that you have switched off the breaker used for the unit.

Opening the panel

Tightly grab top of the front panel and pull it down to open. Then slightly lift the panel up.

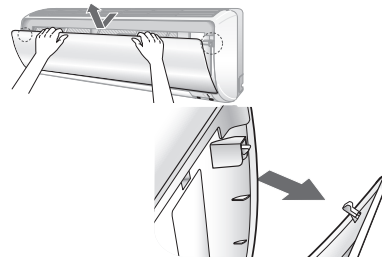

Removing the Air filter

Grab the handle and lift it up. Then, pull the Air filter towards you and slide it down.

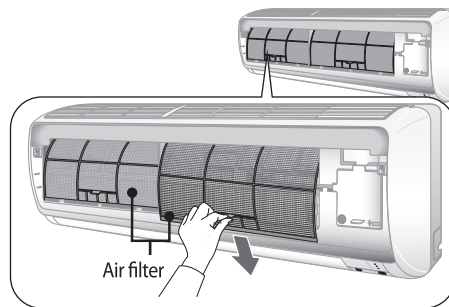

Cleaning the air filter

Washable foam based air filter captures large particles from the air. The filter is cleaned with a vacuum or by hand washing.

Open the panel and put the Air filter out.

Clean the Air filter with a vacuum cleaner or soft brush. If dust is too heavy, rinse it with running water.

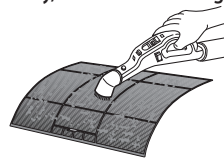

Insert the Air filter back in its original position and close the front panel.

Dry the Air filter in a ventilated area.

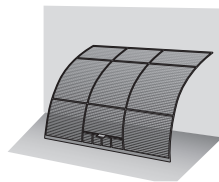

- Clean the Air filter every 2 weeks or when the filter clean reminder lights up. Cleaning term may differ depending on the usage and environmental conditions. In dusty area, clean it once a week.
- If you turn off the air conditioner by pressing **Power**  button, the filter clean reminder will be turned off.
- If the Air filter dries in a confined (or humid) area, odors may generate. If it occurs, re-clean and dry it in a well-ventilated area.

14-5-2 Cleaning Deodorizing and Bio filter (Option)

To remove minute dust particles and odors, deodorizing and Bio filter are installed in the air conditioner. You should clean the filters every 3 months.

1. Open the upper front grille by pulling the lower right and left tabs of the grille.
2. Pull out the deodorizing and Bio filter.
3. Wash the filters with clean water, then dry them in the shade.
4. Insert the filters into the original position.
Note : • You can change the position of filters with each other.
5. Close the front grille.

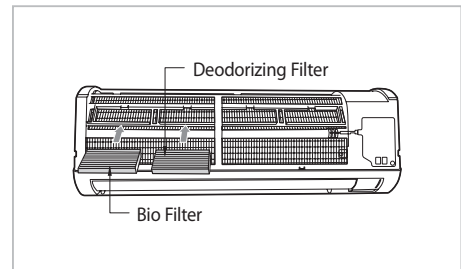

14-6 Installation

14-6-1 Before Installation

Keep the air conditioner outlet and inlet free from its surroundings.
In case of installation, keep the symmetry and fix it to prevent vibration.
The pipe length shall meet the standard as far as possible.

14-6-2 Installation Procedure

■ Location

Install the product in an area to guarantee the best cooling effect, convenience of piping and electric work, and inexistence of vibration or wind.

■ Wall Drilling

Drill the wall downward in a diameter of 60 to 65mm.

■ Fixing Indoor Unit & Outdoor Unit

Fix the air conditioner indoor unit securely to the wall. Secure the outdoor unit in a suitable position.

■ Pipe Spooling & Connecting

You shall cut the pipe with a pipe cutter and grind all the burrs of the cut surface.
Pipe expansion may continue until the pipe surface becomes uneven or torn apart.
Be sure to use a torque wrench to tighten pipes or flare nuts.

<Torque & Depth>

Outer Diameter(D)	Torque(kgf-cm)	Depth(A)
6.35mm(1/4")	140~170	1.3mm
9.52mm(3/8")	250~280	1.8mm
12.70mm(1/2")	380~420	2.0mm
15.88mm(5/8")	440~480	2.2mm
19.05mm(3/4")	990~1,210	2.2mm

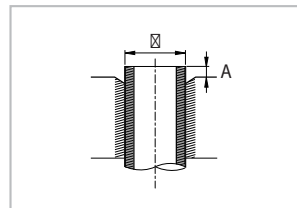

■ Leak Test

Put an inert gas like nitrogen in the outdoor unit pipe and put soap bubbles or other test liquids on the pipe surface for the leak test.

■ Drain Hose Connecting

Install the drain hose downward to drain water naturally. Be sure to pour water into the hose to check if it drains well.

■ Electric & Earth Work

Electric and earth work shall meet the "Electric Facility Technology Standard" and the "Internal Wire Regulation" of the Electric Business Laws.

■ Inspection & Trial Run

Upon completion of the tests, you shall make a trial run while you explain the main functions of the air conditioner to finish the installation.

14-7 Installation Diagram of Indoor Unit and Outdoor Unit

14-7-1 Air-Purge Procedure

- 1) Connect each assembly pipe to the appropriate valve on the outdoor unit and tighten the flare nut.



- 2) Connect the charging hose of low pressure side of manifold gauge to the packed valve having a service port as shown at the figure.



- 3) Open the valve of the low pressure side of manifold gauge counter-clockwise.



- 4) Purge the air from the system using vacuum pump for about 30 minutes.
 - Make sure that pressure gauge show $-0.1\text{MPa}(-76\text{cmHg})$ after about 30 minutes.
 - This procedure is very important in order to avoid gas leak.
 - Turn off the vacuum pump.
 - Close the valve of the low pressure side of manifold gauge clockwise.
 - Remove the hose of the low pressure side of manifold gauge.



- 5) Set valve cork of both liquid side and gas side of packed valve to the open position.



- 6) Mount the valve stem nuts and the service port cap to the valve, and tighten them at the torque of $183\text{kgf}\cdot\text{cm}$ with a torque wrench.



- 7) Check for gas leakage.
 - At this time, especially check for gas leakage from the 3 way valve's stem nuts, and from the service port cap.

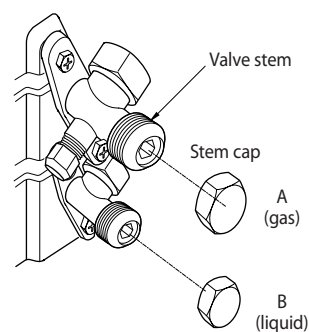
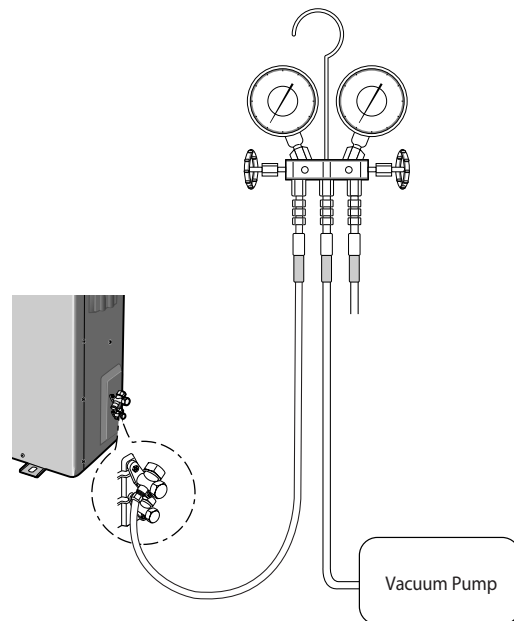
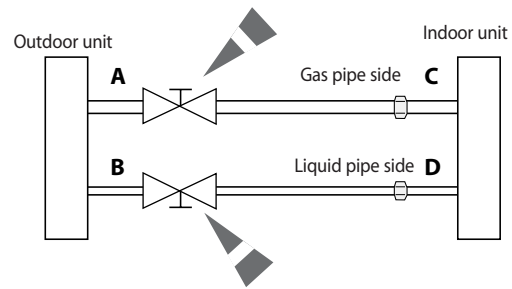

14-7-2 "Pump down" Procedure

Pump down will be carried out when an evaporator is replaced or when the unit is relocated in another area.

1) Remove the caps from the 3 way valve and the 3-Way valve.



2) Turn the 3-Way valve clockwise to close and connect a pressure gauge (low pressure side) to the service valve, and open the 3 way valve again.



3) Set the unit to cool operation mode.
(Check if the compressor is operating.)



4) Turn the 3-Way valve clockwise to close.



5) When the pressure gauge indicates "0" turn the 3-Way valve clockwise to close.



6) Stop operation of the air conditioner.



7) Close the cap of each valve.

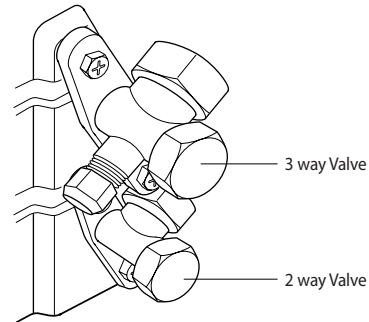

 **Remarks**

Relocation of the air conditioner

- Refer to this procedure when the unit is relocated.
- Carry out the pump down procedure (refer to the details of 'pump down').
- Remove the power cord.
- Disconnect the assembly cable from the indoor and outdoor units.
- Remove the flare nut connecting the indoor unit and the pipe.
- At this time, cover the pipe of the indoor unit and the other pipe using a cap or vinyl plug to avoid foreign material entering.
- Disconnect the pipe connected to the outdoor unit.
At this time, cover the valve of the outdoor unit and the other pipe using a cap or vinyl plug to avoid foreign material entering.
- Make sure you do not bend the connection pipes in the middle and store together with the cables.
- Move the indoor and outdoor units to a new location.
- Remove the mounting plate for the indoor unit and move it to a new location.

15-1. POWER SUPPLY

Working Voltage	176V ~ 264V
Voltage Imbalance	Within a 3% Deviation from Each Voltage at the Main Terminal of Outdoor Unit
Starting Voltage	Higher than 80% of the Rated Voltage

15-2. WORKING RANGE

Applicable models:

AQV12PSBANXAX AQV12PSBAXXAX

The temperature range is indicated in the following table.

Cooling

working range	min (°C)	max (°C)	rated (°C)
outdoor	-10	46	35
indoor	16	32	27

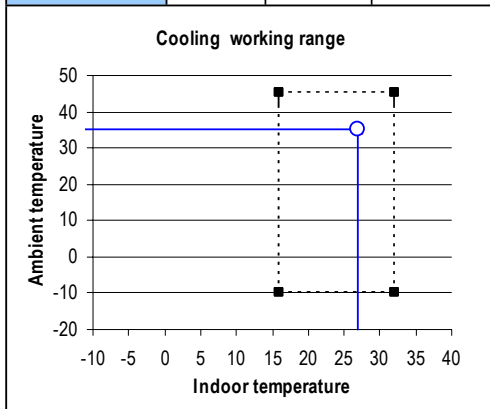

Heating

working range	min (°C)	max (°C)	rated (°C)
outdoor	-10	24	7
indoor	—	27	20

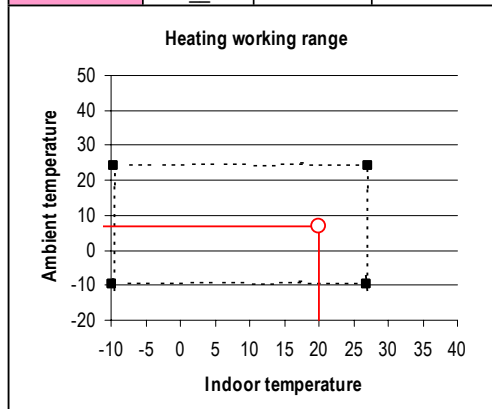

Applicable models:

ASV09PSBANXAP ASV09PSBAXXAP
 ASV09PSBANXAP ASV09PSBAXXAP
 ASV09PSBANXAX ASV09PSBAXXAX
 ASV09PSBANXAX ASV09PSBAXXAX
 ASV09PSBANXAZ ASV09PSBAXXAZ
 ASV12PSBANXAZ ASV12PSBAXXAZ

The temperature range is indicated in the following table.

Cooling

working range	min (°C)	max (°C)	rated (°C)
outdoor	16	46	35
indoor	16	32	27

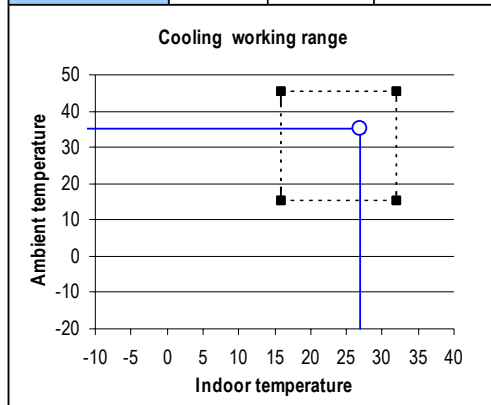



GSPN(Global Service Partner Network)

Area	Web Site
North America	http://service.samsungportal.com
Latin America	http://latin.samsungportal.com
CIS	http://cis.samsungportal.com
Europe	http://europe.samsungportal.com
China	http://china.samsungportal.com
Asia	http://asia.samsungportal.com
Mideast & Africa	http://mea.samsungportal.com

This Service Manual is a property of Samsung Electronics Co., Ltd.
Any unauthorized use of Manual can be punished under applicable
International and/or domestic law.

© Samsung Electronics Co., Ltd. Nov. 2007.
Printed in China.