

ZEHN KITCHEN FAUCET

KF.17ZN.1312

Description

- Magnetic docking system
- Pull-out sprayer with 2 stream functions and built-in swivel
- Solid brass construction
- Brass faucet spray head
- 3/8" compression fitting

Cartridge

- CE.1700.R - ceramic disk cartridge (right turn)
- CE.1700.L - ceramic disk cartridge (left turn)

Flow Rate

- 1.75 gpm | 6.6 lpm | 60 psi

Finishes Available

- Chrome (CC)
- Stainless Steel (SS)
- Matte Black (MB)
- Antique Bronze (AB)
- Polished Nickel (PN)
- Brushed Gold (BG)
- Matte Black / Chrome (CB)
- Matte Black / Stainless Steel (SB)
- Matte Black / Polished Nickel (PB)
- Matte Black / Brushed Gold (BGB)

(Model Pictured: Chrome)

Codes / Standards

- Uniform Plumbing Code (UPC®)
- ASME A112.18.1/CSA B125.1
- NSF 372
- NSF/ANSI 61

Warranty

- Limited lifetime warranty against all manufacturing defects to the original consumer purchaser (see full warranty for more details)

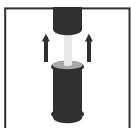
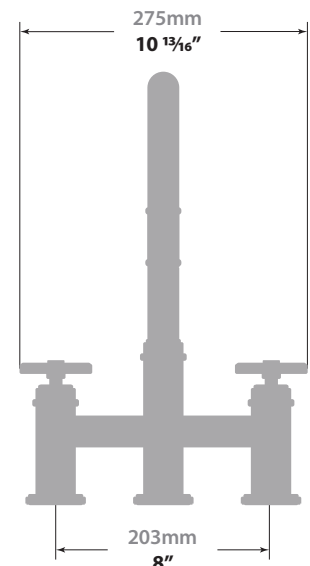
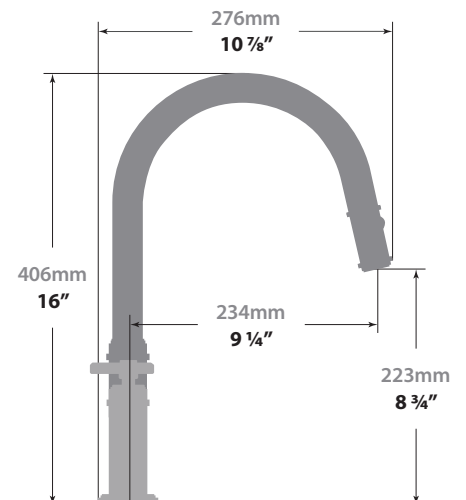

Magnetic
Mechanism

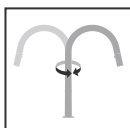

360° Swivel
Spout