



Smart Lock
Catalog description

Dear user,
Thank you for purchasing the smart door lock

To improve the quality survival with innovative technology, to create the world's most outstanding, most innovative products so that enterprises become the industry benchmark. We always adhere to the "quality survival, service and development" business philosophy. In the intelligent lock industry, all constantly improve the product quality system. our company keep up with the pace of the times. We always walk in the forefront of the industry, and always steadfastly protects the people's property safety! From products to service, we always pursue to provide you with a full range of intimate and comfortable service! Thank you for your support for smart door lock!!

Disclaimer:

We have done our best to ensure that the information provided in this manual is correct and reliable, but we cannot fully guarantee errors before and during printing. Sometimes we in order to improve the performance, reliability and safety of components and systems, may upgrade the product, which may be somewhat inconsistent with the contents of the manual, but does not affect the actual operation, if there is a change is not known, please understand! Our company will update the content regularly. If you have any questions, please call our company to answer. The final interpretation of the entire contents of this manual is the right of the Company. The functions described in this statement are not used as a reason for the use of this product for special purposes and the Company shall not be liable for accidents and hazards caused by the customer's improper operation.









Catalog description

Safety and precautions- - - - -	2
Configuration List- - - - -	3
Lock Appearance dimension drawing - - - - -	4
Dual latch install diagram - - - - -	5-6
Lock install diagram - - - - -	7-9
Functions and Operations - - - - -	10-12
Other instructions - - - - -	13
System Parameters- - - - -	14

Safety and precautions

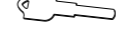
- Smart door lock as a high-tech products, the installation of good or bad directly affect the normal operation and service life of the door lock, it is recommended that you install the door lock after the room has been decorated, please choose to ensure the quality of personnel to install, the factory strictly according to the company's installation standards for operation.
- Do not use in environments with strong radiation, high magnetic field, and high temperature with corrosive substances, so as not to affect the performance and life of the smart lock.
- Please initialize the door lock as soon as the door lock installation is completed and restore the lock to the initial state. And please set your electronic key Settings immediately after initialization to prevent others from illegally opening your door lock.
- Please using or change the same brand 4 pcs AAA 1.5V alkaline battery, mix using of New Old battery OR using Non-destructive battery will destroy your door lock.
- In order to better feel the convenience and advanced of the company's products, please carefully read this manual before use, if there are any doubts, can directly to the company's customer service center or headquarters service center, the company has professional technical personnel for your eyes, to ensure your use of rest assured.
- **Battery not include on shipment.**

Configuration list

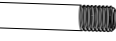
Item No.	Picture	Accessories	Quantity	Remark
1		Mortise	1pc	50×50MM (22×160MM)
2		Door buckle plate	1pc	
3		Door buckle box	1pc	
4		IC card	2pc	If lost, please cancel from on the smart lock
5		Key	2pc	Please store separately, do not put in the indoor.
6		Square rod	1pc	8×8×80MM
7		Cross round-head screw	1pc	4×30MM
8		Cross round-head screw	2pc	4×45MM
9		Installation stud	1pc	4×5×30MM
10		Installation stud	2pc	4×5×35MM

Thank you for purchasing the smart Lock series, when you open the box, please check the inside. If you find that the above contents are missing from the box, please contact the local dealer as soon as possible to ensure prove your use.

Lock Appearance dimension drawing

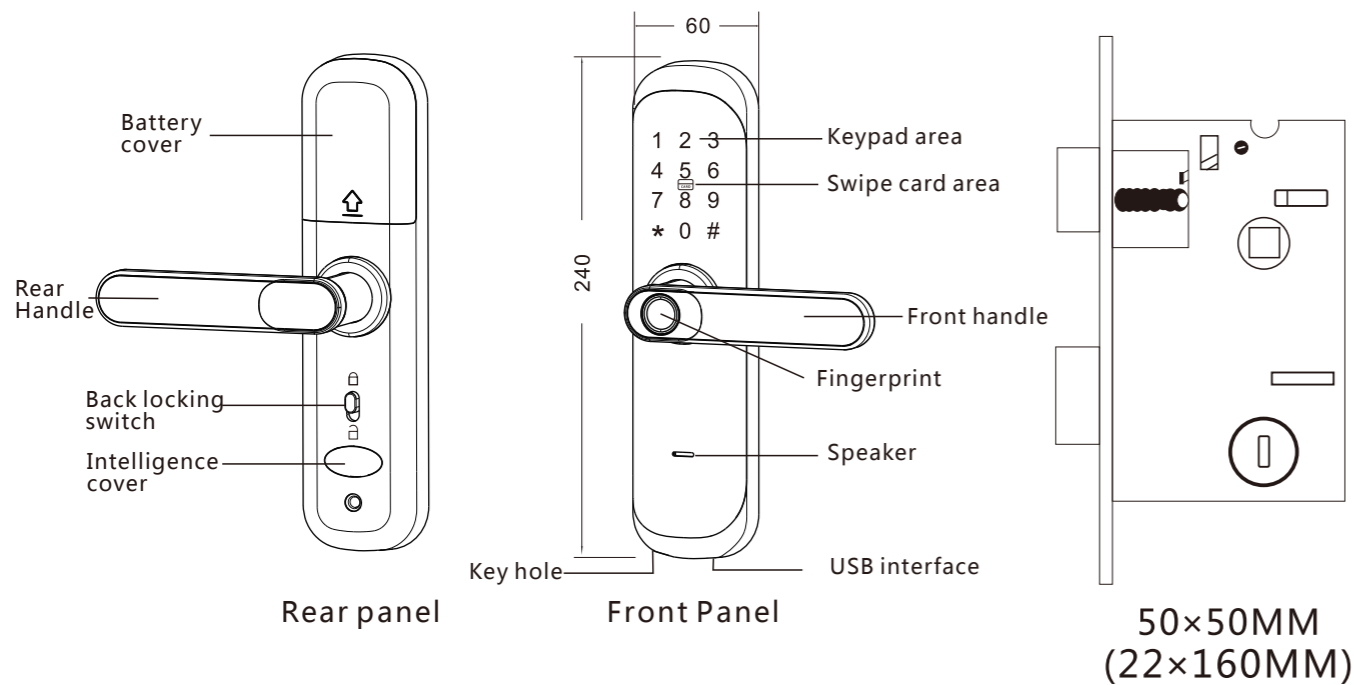

Dual latch install diagram

Remind

Product performance

Ideal for home, office indoor door lock

Suitable to 38-50mm thickness door

Determine the door direction

Stand outside of the door

Adjust the direction of the handle and latch bolt accordingly to the opening direction when installing the door.

Change lock body direction

When installing the lock body, the latch bolt is on the upper side, the dead bolt under the latch bolt, and the inclined surface of the latch bolt is facing the opening direction.

1. Reserve the lock body and latch bolt is down (refer to picture 2)

2. Push the latch bolt lower than front plate, stopblock is down and rotate 180 degrees (refer to picture 2)

3. Push the latch bolt into hole (refer to picture 3)

3. Push the latch bolt into hole (refer to picture 3)

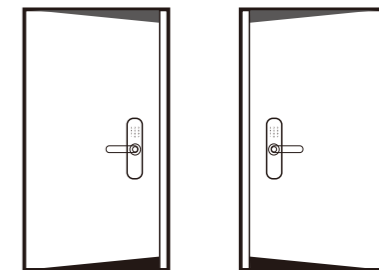

Left open

Right open

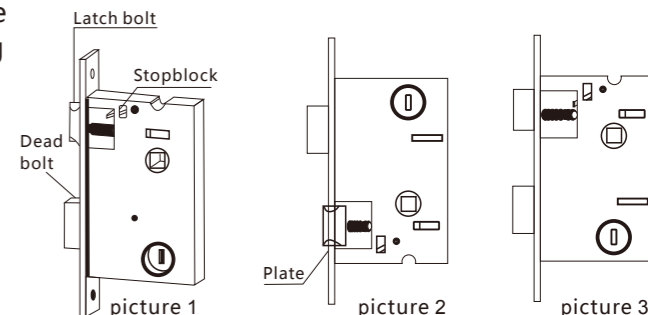

Cutting template

1. Please refer template carefully to drill hole
2. If there is a deviation in the hole, the lock body and panel assembly are put into the door and the hole is corrected until appropriate.

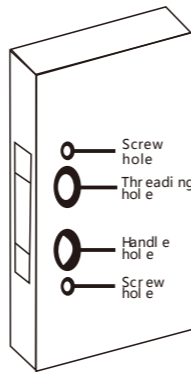

Handle Reversing Method

1. Remove the cross screw as the drawing and turn the handle up 180 degrees in the direction of the arrow
2. After adjusting the direction of the handle, then install the cross screw to the original position and tighten it to complete the reversing.

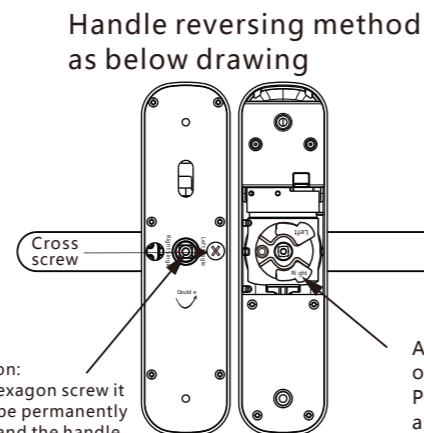

Caution:
The hexagon screw it must be permanently fixed and the handle reversing without disassembling.

As shown, the "Left" and "Right" on the spare parts as the arrow. Please operate it and follow the left and right as diagram.

Install lock body & Strike Box

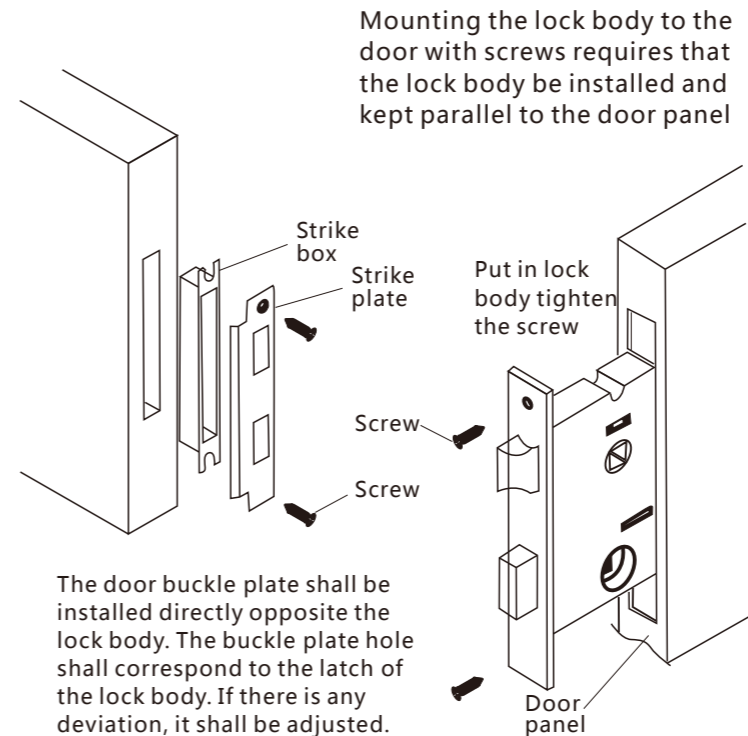

Mounting the lock body to the door with screws requires that the lock body be installed and kept parallel to the door panel

Install lock

Front panel and back panel docking power cord

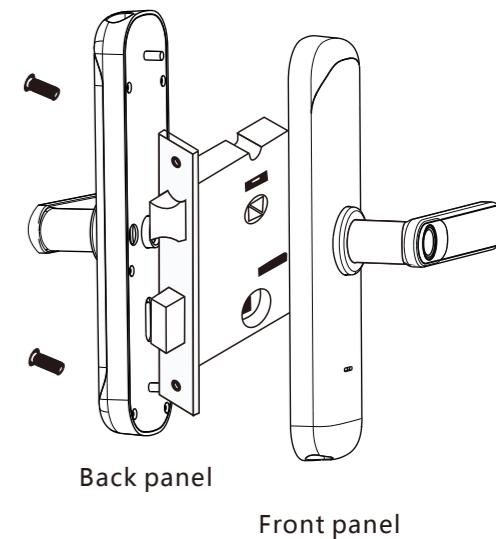

Door direction: Right open

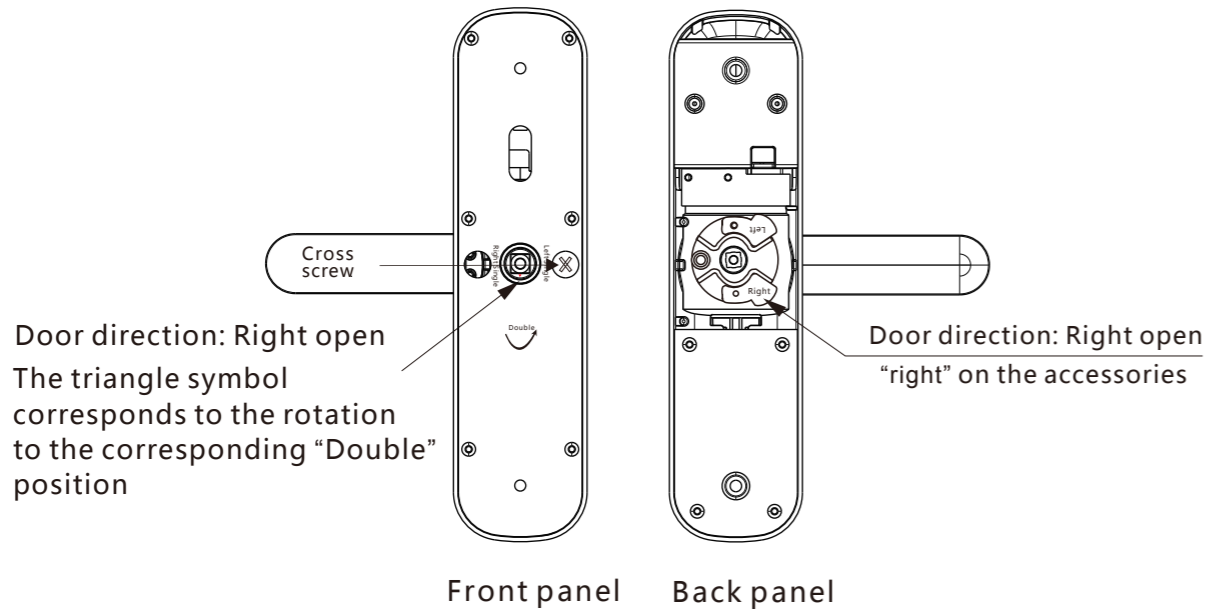

Door direction: Left open

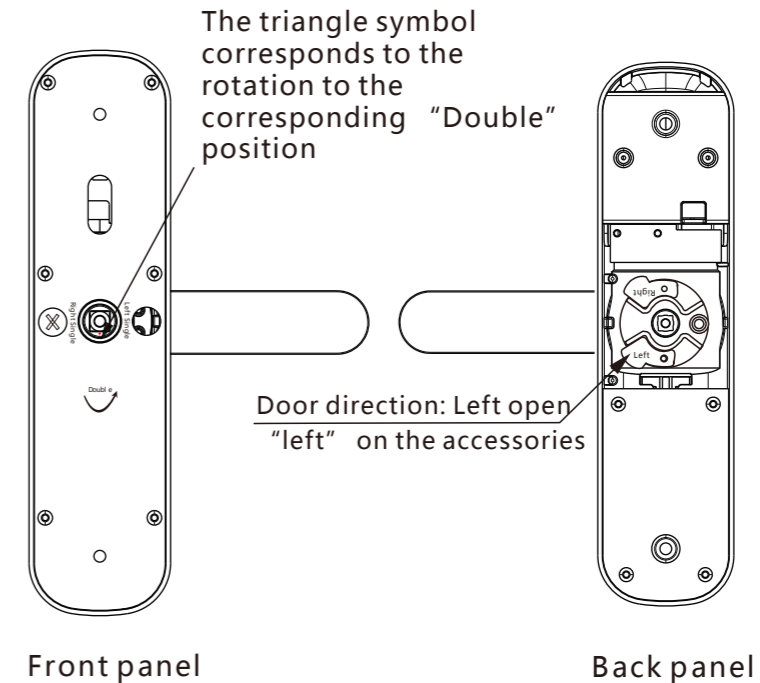

1. Function and Operation

1.
 - 1)Unlock information: refers to the input fingerprint, password or IC card information (including administrators and ordinary users).
 - 2)Key "*" : Clear key/back key.
 - 3)Key "#" : Confirmation key or menu function key.
2. Original state
 - 1)The factory administrator initial password is "123456" , under the initial state any fingerprint, IC card or password can open the lock.

2.Access door lock function management

Initialization state

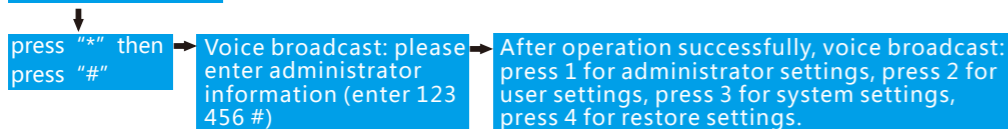

1.Administrator settings

- 1) Add administrator press "1"
Add administrator press "1" , enter administrator information, input fingerprint or password(Fingerprint inputting 4 times, password input 6-8 bit digital twice(888888#), IC card input once.

- 2) Delete administrator information press "2"
Enter number press # confirm(002#)(Unable to delete all, the first administrator reserved)
- 3) Add a network
Hotspot connection press "1"
Intelligent connection press "2" (TUYA)

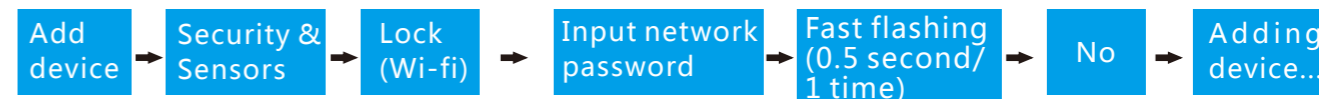

Remote unlocking: wake up the screen and press "9" + "#" . There will be a voice prompt: requesting remote unlocking.

Hotspot connection mode;
Intelligent connection mode;

When the network is successfully added, the "*"5"1"2"lights on the keyboard in order, and voice prompt "successful"

1) When the network add failure, the "*"5"1"2"none lighting, voice prompt "Failure"

User setting

Add user

Press "1" voice prompt: please input user information, input fingerprint or password(fingerprint input 4 times, password input 6-8 bit digital twice), IC card input one time. It can input another user information after it successfully.

2) Press "2" for delete user

Press "2" voice prompt: press "1" input number delete, press "2" delete all, press "1" input number(010#) delete success.

3.System setting

1) Press "3" voice prompt: press "1" for voice setting; press "2" for unlock mode setting; press "3" language setting, press "4" time setting, press "5" for modify room number.

2) Unlock mode setting

Press" 2" voice prompt: press "1" for single unlock, press "2" for combine unlock. Press "1" voice prompt : operate success.

3)Language setting

Press "3" voice prompt: Press "1" for Chinese, press "2" for English.

4)Time setting

Press "4" voice prompt: present-time is 1903041153, please modify. Please modify based on the format (year-month-day, for example: 1903041153), and then press # to confirmed, it would tell you "Successful"

5)Room number modify

Press "5" voice prompt: room number 8888, please modify. You can input 4 numbers and press # to confirm. It would tell you "Successful"

4. Restore factory setting (Press the restore key under the battery cover on the rear panel of the lock around 6-8 seconds and hear a "Di" beep tone, restore successfully)

Other notes

1) The system will automatically enter the invalid input state if the unauthorized unlocking information is continuously incorrectly input for more than 5 times within 5 minutes, and the invalid input state will lasts for 90 seconds.

2) After the voltage is lower than 4.5v, the lock will automatically alarm every time when it is opened. After the alarm, the lock can be opened for 200 times. After the number of times exceeds, each unlock delay is 5 seconds, new batteries must be replaced before the number of times available.

3) Password peeping prevention function: Input password as follows when opening the door with password: XXX password XXX; you can add some extraneous codes before and after the password, and then press # to confirm. The password must be included in the input contents.

4) If there is no operation more than 10 seconds , system will automatically exit.

5) Initialization setting: Press the restore key under the battery cover on the rear panel of the lock around 6-8 seconds, all the unlock information and records will clear after initialization (Please carefully operation)

6) Normal open mode under close status, press 5 #, voice prompt "please input unlock information" , input unlock information, voice prompt "Normal open mode, please attention to lock" .

7) Normal open mode under open status, press "5#" , voice prompt " Normal open closed)

8) Anti-lock function: After pressing back locking key, the voice says "the door is locked". Now, ordinary users cannot open it, and only administrators can unlock.

9) Under initialization status, input "555666888" ,support switch language of "English and Chinese" .

Technical Parameters

Power supply: 4.5V-6V(4pcs AA batteries)

Quiescent current: <50-65uA

Administrators number: 9

Unlock methods: Fingerprint, IC card, Password,
Key, WeChat Mini program, Tuya smart(Optional)

Working current: > 250uA

Fingerprint: <= 100

Card: <= 100

Password: <= 100

Password length: 6-8 bit

Phantom password: 16 bit

Lower voltage alarm: 4.5±0.2V

Working temperature: -10°C~60°C

Working relative humidity: 20% ~ 93%

Warranty Card

The Company provide life-long maintenance for the sale of products , from the date of purchase within one year, the company provides free warranty service;If the following cases are not held for free warranty services:

- (1) If there is no product warranty card or valid purchase voucher, the warranty card and purchase certificate do not match the product;
- (2) Damage caused by human factors, including use in an abnormal working environment, damage caused by the use of a non-stated manual, etc.;
- (3) The user's private dismantling, self-repair, modification or maintenance by a non-authorized unit of the Company or other irresistible factors damaged"

User name		Contact Tel	
Address			
Model No		Lock cylinder No	
Serial No			
Purchase date		Install date	
Supplier			
Contact address			
Contact Tel			
Supplier's Official seal			

Note to users:

In order to protect your Legal rights, please keep the service card and the relevant purchase voucher, to protect your Legal rights in warranty services, warranty card once modified will be invalid

