

# LUXURY LED SHOWER INSTALLATION INSTRUCTION

SHOWERING  
WITH  
ROMANTIC  
AND FUN



Bluetooth music speaker



Remote control  
LED light



64 RGB  
LED color

## LED shower system installation instruction manual

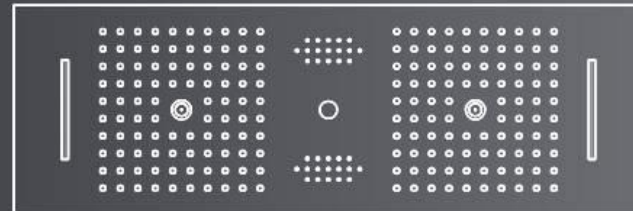

SHOWERING WITH ROMANTIC AND FUN

❖ **Product Specification**

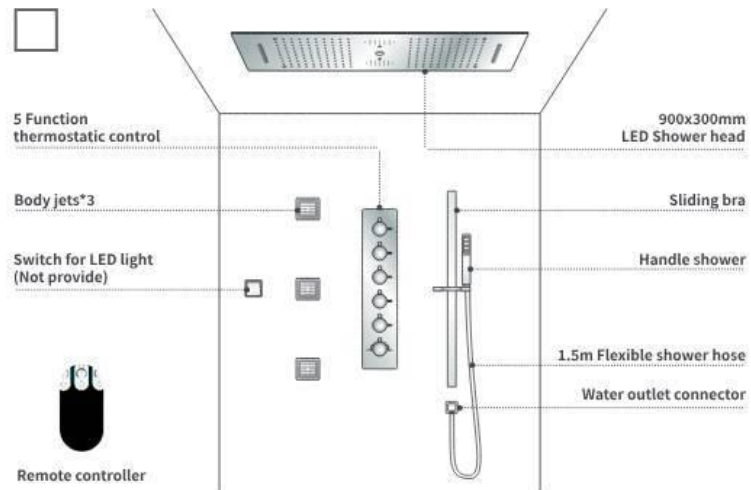
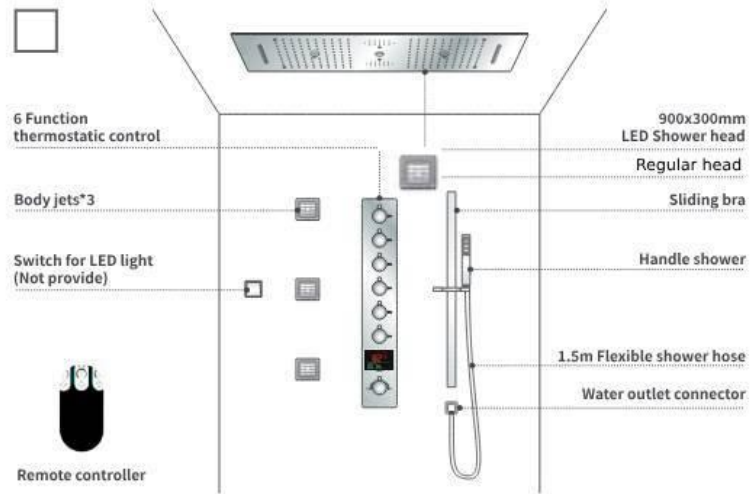

❖ **Product Specification**

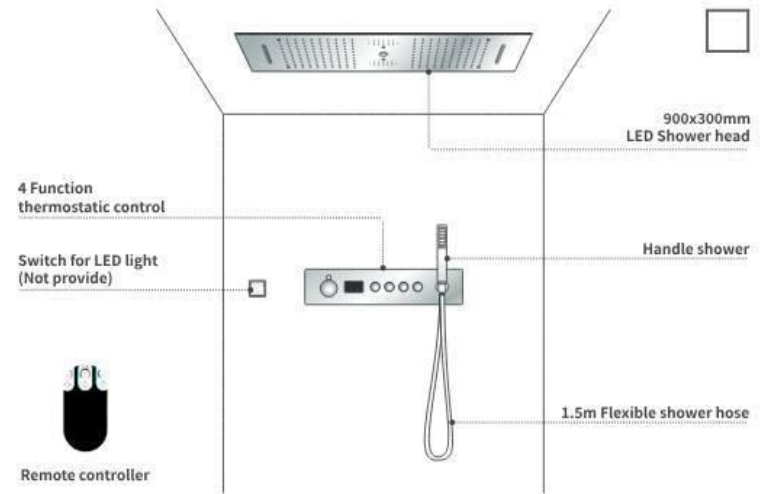

❖ **Install Caution :**

Please read carefully these instructions before proceeding with the product installation.  
It is indispensable to flush through the supply pipes before installing and using the product.

❖ **Technical Data :**

Operating pressure = 0,3 - 1MPa (3 - 10bar)  
Large differences in pressure between the hot and the cold water supply should be balanced.  
Recommended hot water temperature = 60° C - 70° C  
Maximum hot water temperature = 70° C

❖ **Cleaning :**

It is recommended to clean the tap with a soapy solution.  
Never use cleaners containing acids, abrasives, or solvents.  
Towel dry any water left on the product after each use to avoid water spots on its surface.  
To avoid obstructions caused by scale build-up at the aerator it is recommended to periodically dismount it and submerge it in water with vinegar.

❖ **Cartridge Change :**

It is essential to turn off the water supply system (angle valve or stopcock) and to close the pop-up waste before beginning with the cartridge change.  
The stronger you tighten the cartridge nut, the harder the lever will move.

➤ **Bom List**

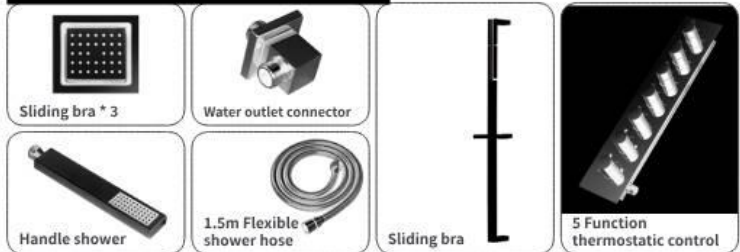
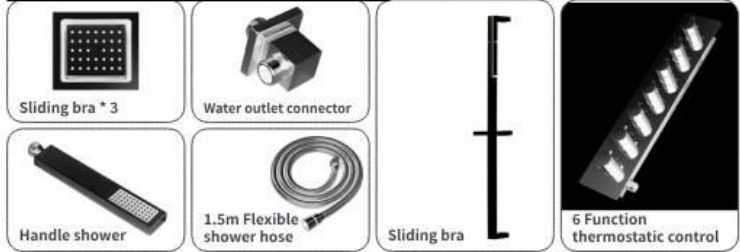

➤ **Bom List**

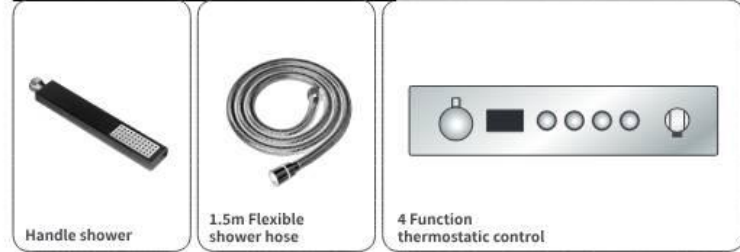

Please read the safety warnings carefully  
Tools needed as below



❖ Power / water pipe - layout

Before installation, well plan the pipe groove in the required position for the product

according to the actual installation location of the wall and ceiling.

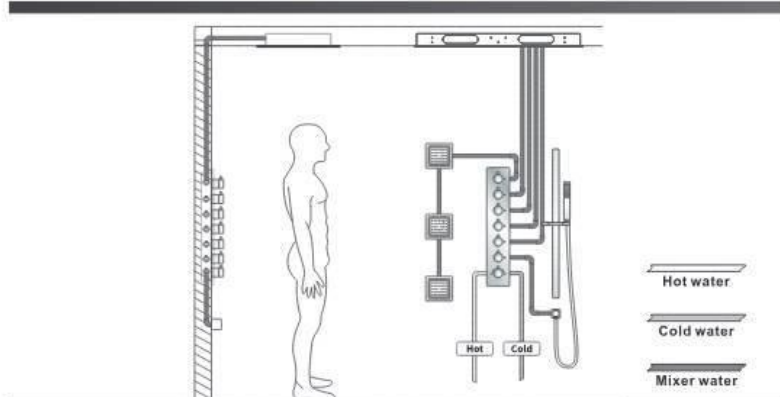
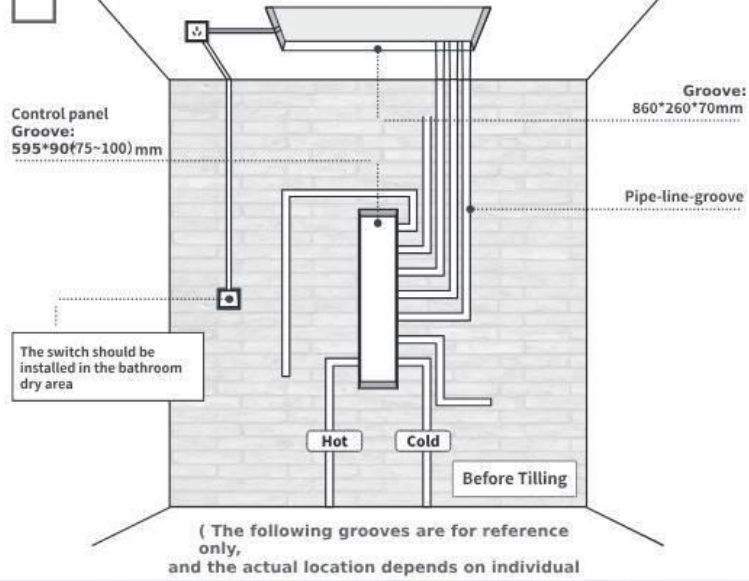

Schematic diagram of waterway installation

❖ Power / water pipe - layout

Before installation, well plan the pipe groove in the required position for the product

according to the actual installation location of the wall and ceiling.

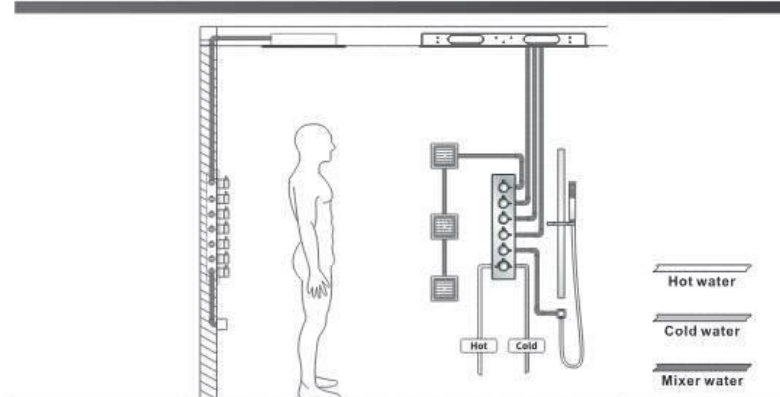
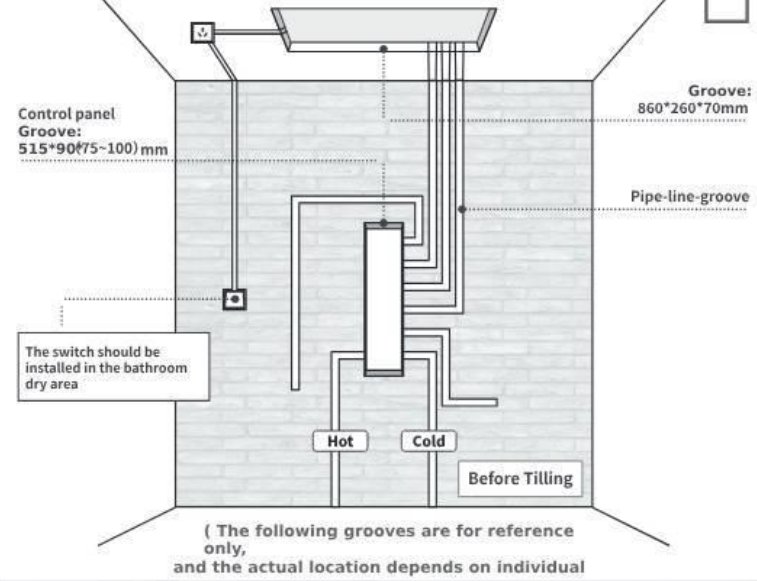

Schematic diagram of waterway installation

➤ Power / water pipe - layout

Before installation, well plan the pipe groove in the required position for the product

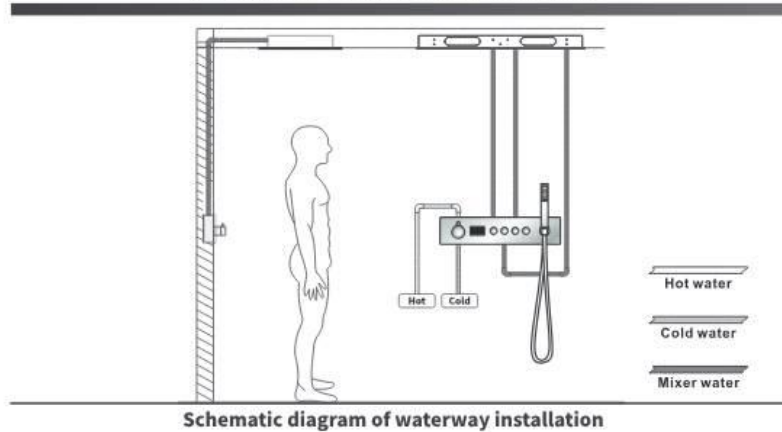
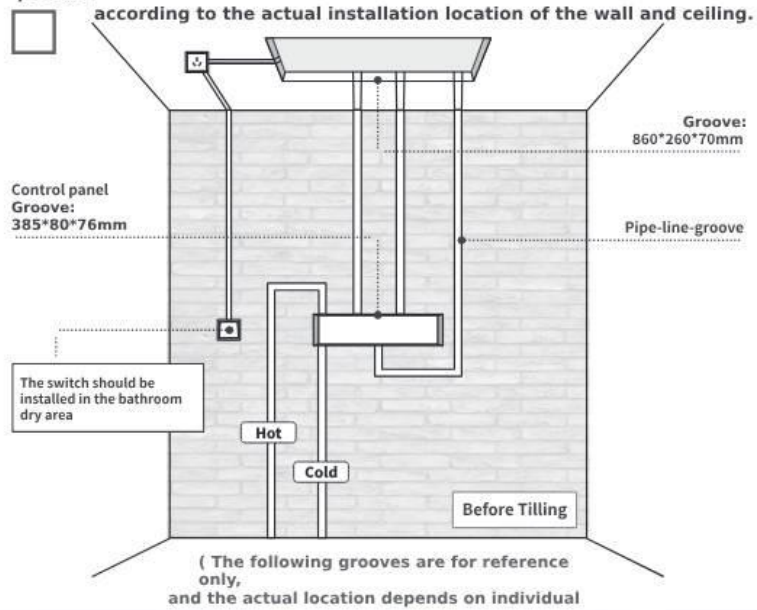

➤ Luxury LED Shower spare parts Exterior Dimensions

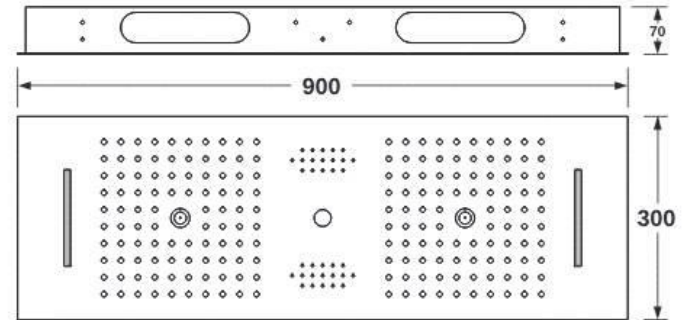

➤ Luxury LED Shower spare parts Identification chart

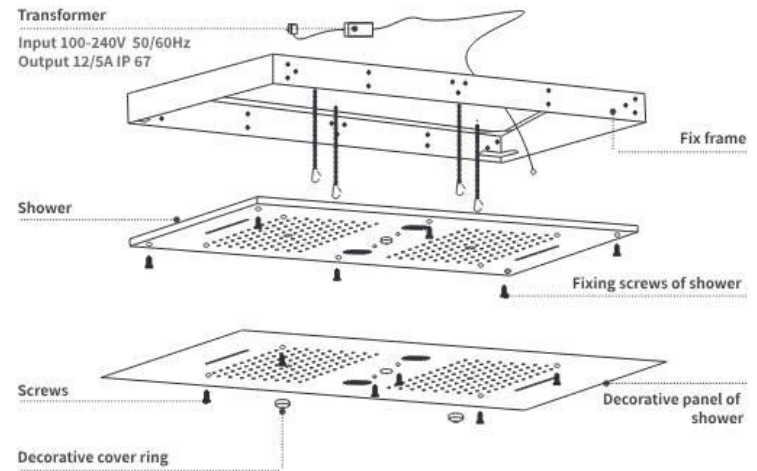

➤ **Luxury LED Shower spare parts method**

**1** Power / water pipe - layout

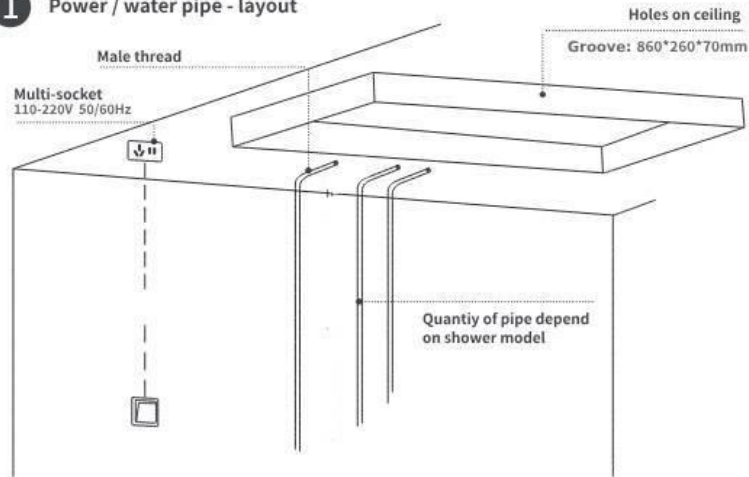

**2** Shower head installation fixed frame

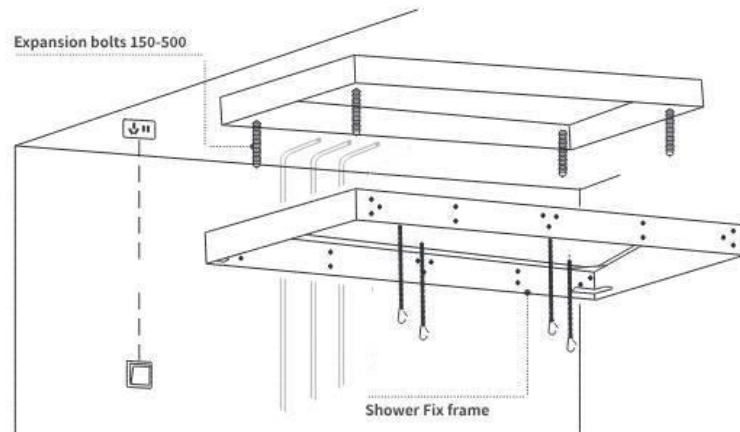

➤ **Luxury LED Shower spare parts installation instruction**

**3** layout for power / water pipe

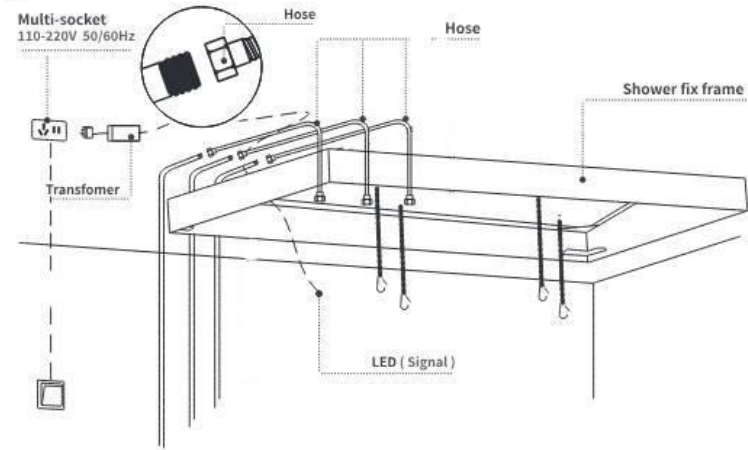

**4** Install Shower

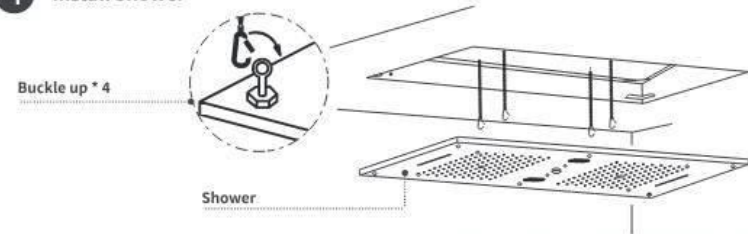

**5** Connect the water inlet pipe

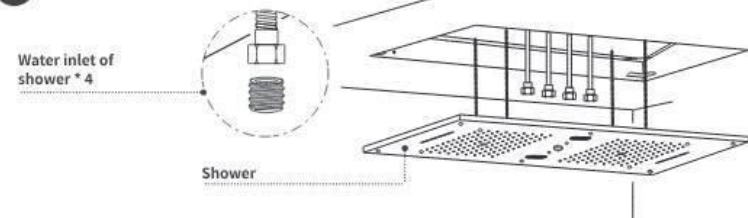

❖ **Luxury LED Shower spare parts installation instruction**

**6** Connect LED (signal line)

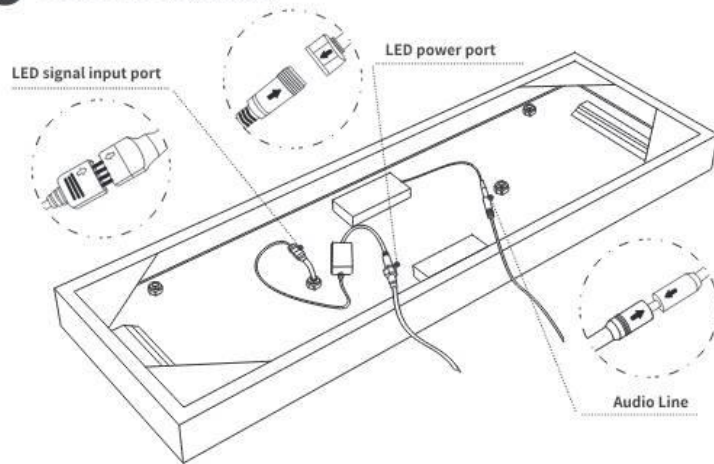

**7** Shower installation

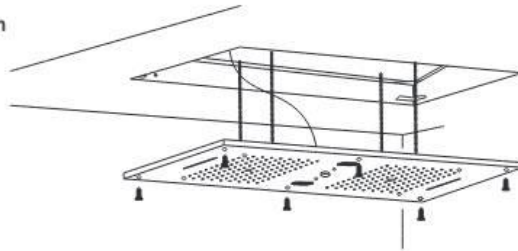

**8** Fix the decorative panel of shower

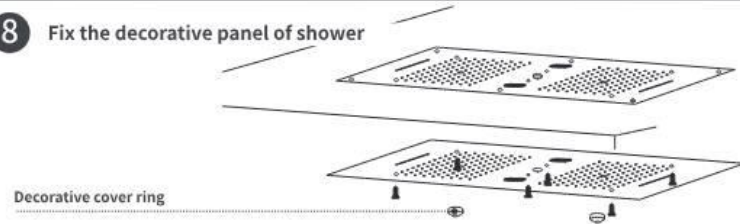

❖ **Installation method**

**9-1** 6 Function thermostatic control shower valve

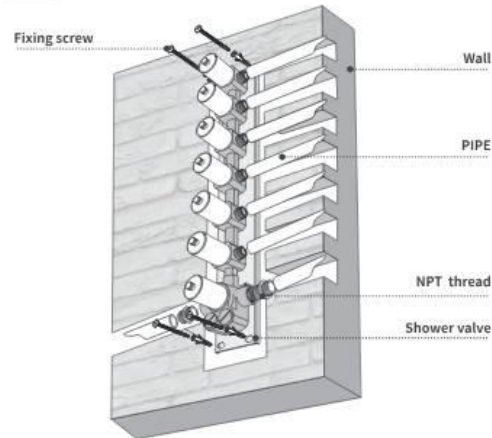

**Before Tiling**

Please grooved and install the shower valve according to the size drawing, the depth of the groove is about 75-110mm

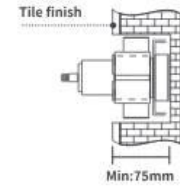

After the installation is complete, turn on the water source and try to see if the water is

**10-1** 6 Function thermostatic control shower valve

Install the handles

**After Tiling**

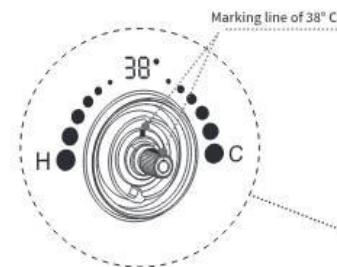

Thermostatic handle installation: Remove the handle and check whether the 38° C line of the thermostatic valve core is aligned as bellow picture. (This is the marking line for testing the water temperature of 38° C.)

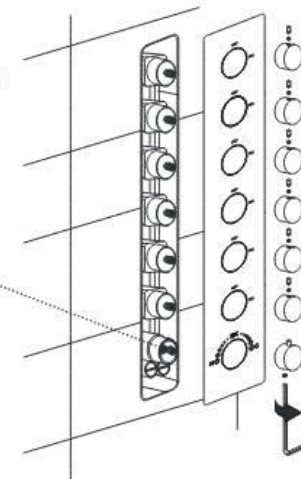

Installation method



9-2

5 Function thermostatic control shower valve

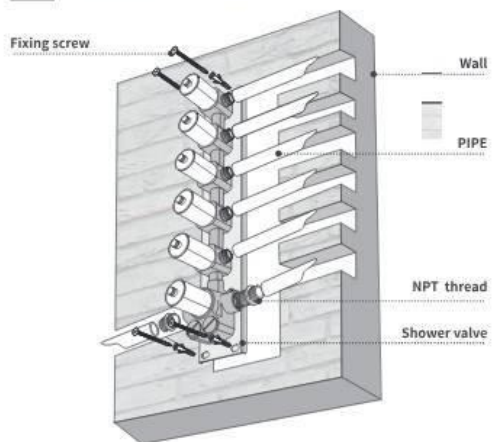

Before Tiling

Please grooved and install the shower valve according to the size drawing, the depth of the groove is about 75-110mm



After the installation is complete, turn on the water source and try to see if the water is

Installation method



9-3

4 Function thermostatic control shower valve

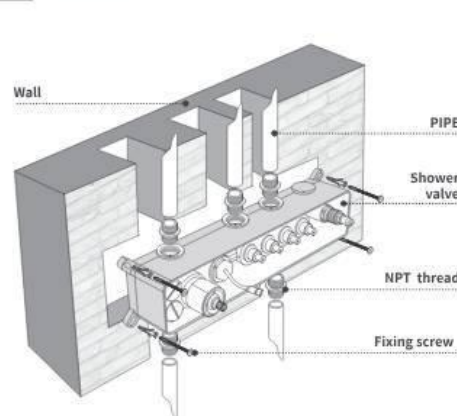

Before Tiling

Please grooved and install the shower valve according to the size drawing, the depth of the groove is about 77-85mm

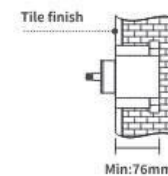

After the installation is complete, turn on the water source and try to see if the water is

10-2

5 Function thermostatic control shower valve

Install the handles

After Tiling

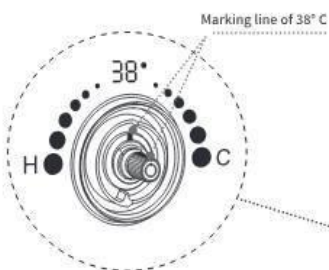

Thermostatic handle installation: Remove the handle and check whether the 38°C line of the thermostatic valve core is aligned as bellow picture. (This is the marking line for testing the water temperature of 38°C.)

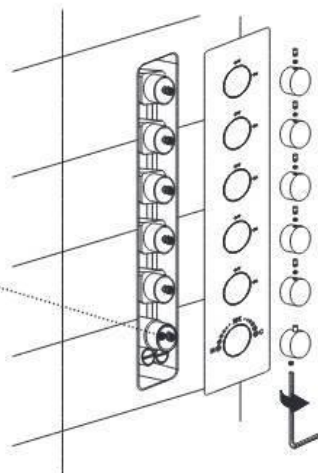

10-3

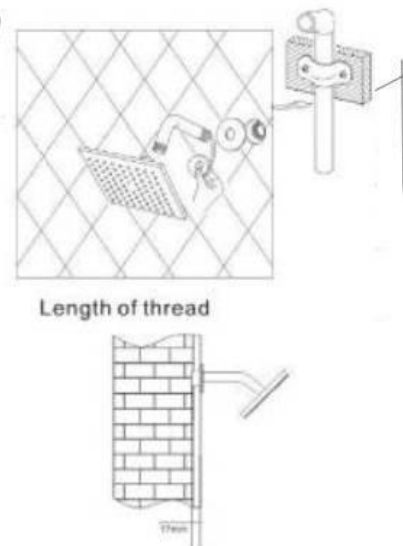



### Installation method

#### 11 Body jets \* 3

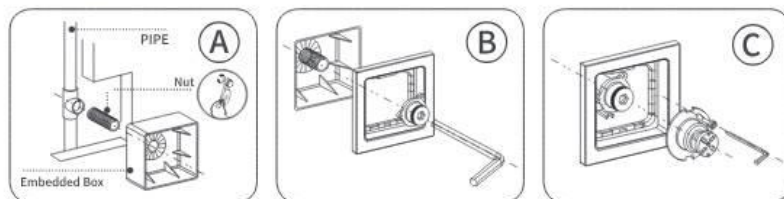

##### Before Tiling

1. Please groove 110\*100mm according to the embedded box size.
2. Wrap with the appropriate raw material and connect to the water inlet pipe.
3. Put the embedded box to the groove and fix the crews from back side.

##### After Tiling

1. Install the cover.
2. Fix the screws by using H10 hexagonal screw.

##### After Tiling

1. Line up the Card slot and the outside double-steel-bars and then push in completely.
2. Using the M4\*20 hexagon-socket screw to tighten the component and the connector. Make sure the cover component is not loose.

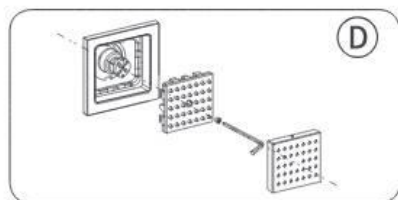

##### After Tiling

1. Install the components, make sure the 'components' steel-bars clip into the main body 'component's card slot. Then using the M4\*12 hexagon socket screw to tighten them. Pay attention to prevent deformation of the cover when you tighten them.
2. Install the cover.

#### 12 Water outlet connector

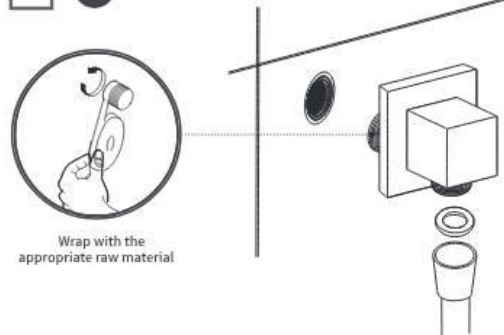

Wrap with the appropriate raw material

Installing on the required outlet pipe

##### After Tiling

### Installation method

#### 13 Sliding Bra

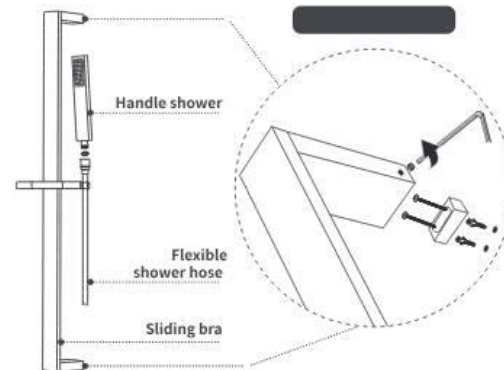

### USER MANUAL

Main parameter:  
 Panel controller:  
 Working Temp.: -20~60  
 Supply Voltage: DC12-24V  
 Size: L50\*W35\*H23mm  
 Output: 3Channel  
 Output Current: <2A(each channel)  
 Connection mode: common anode

Touch Remote:  
 Working voltage: 1.5V\*3V  
 Emission current: 10mA  
 Working Current: 300uA  
 Standby Current: 3uA  
 Standby time: 6 mouths  
 Control distance: 20M  
 Color pulley point: 60

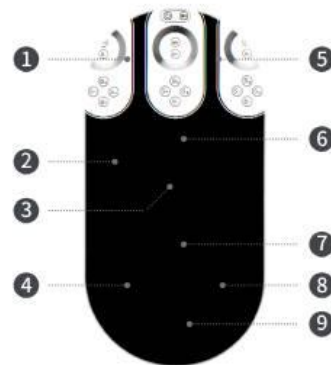

1. Turn ON/OFF
2. Color Touch Ring
- 3/6. Color Temperature adjusting
- 4/8. Dynamic Speed adjusting
5. Mode Switch
- 7/9. Dynamic Brightness adjusting

Touch remote use instruction: .....

1.Touch remote have 64 touch key,each keys function below:  
Pause:on the dynamic mode,you can make the controller to stop the current state now.

2.Power supply management:  
Stop to use the remote more than 20s,the remote will enter the stand by state(untouchable state);slightly shake once,then the remote will come back to the normal working state(touchable state)

3.Indicator light instruction:  
Slightly shake once,then the remote will come back to the normal working state(touchable state)  
1.the remote is idle or sent signal when the PWR bright,PWR is off,then means the remote is in standby state;  
2.RF is bright,that means remote is sentting signal.off means there is no signal sending

**Mode:**

NO.	FUNCTION	REMOTE
1	Static red	Brightness is adjustable Speed is unadjustable
2	Static green	
3	Static blue	
4	Static purple	
5	Static blue-green	
6	Static yellow	
7	Static white	
8	R G B Jumping	Brightness is adjustable Speed is adjustable
9	R G B Gradual	
10	7-Colors Jumping	
11	7-Colors Gradual	

**Controller connections shown:**

Touch remote use instruction:  
Remarks:  
1.This product should be commissioned and installed by qualified personnel.  
2.2.This product can not be waterproof,need to avoid sun and rain,if installed outdoors,please use waterproof box.  
3.Good heat dissipation conditions will extend the life of the LED controller,please install the product in a well-ventilated environment.  
4.Please do not install or use such products in lightning,thunder,strong magnetic or high voltage applications.  
5.Please check whether the output voltage of the LED power supply used meets the product voltage range requirements.  
6.The diameter of the wire used must be sufficient to load the connected LED luminaire,and ensure that the wiring is firm,to avoid the wire overheating or poor contact triggers the accident.  
7.Before power-on debugging,ensure that all wiring is correct to avoid damage to the luminaire due to wiring errors.

❖ **Safety warning notes:** .....

Content for users as shown in the following major issues of, in order to prevent the occurrence of personal injury or property loss, be sure to respect. Please read the safety warnings and precautions, to be properly use of this product.



Warning

Be sure to respect the users,if ignoring the wrong side of this operation that may cause serious personal injury or significant property loss, resulting in the loss of no responsibility of the Company. Failure of this product must be carried out by professionals to repair and protect, to the demolition of this product is strictly prohibited.

If you ignore this marker, the possibility of a minor personal injury or property loss.

Please do not permission to demolish, repair, alteration of the products, such as the replacement of the power cord

The absolute prohibition of touch the electrical outlet with wet hands. Use wet hands to touch the power seat, there might cause an electric shock hazard.



Prohibited

Please do not connect water pipes outside the home, such as industrial sources. It may lead insufficient water pressure or damage the skin.

Demolition or repair of products, be sure to pull the plug to ensure security. It may get an electric shock.

Please do not use defective power supply, plugs, sockets, please contact Service Center for timely replacement. It may lead to fire.



Implementation

Please take this as a specialized product in bathroom, not for other purposes. It may lead to fire, leakage, injury.

No use this product for a long time, please unplug the power, let the water out completely to protect the motor. It may lead to fire, leakage. No implementation of water, it may lead to deterioration caused by skin disease.

