

# THERMOSTATIC SHOWER MANUAL

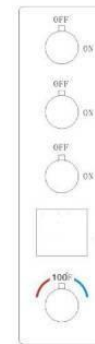

## Installation Step

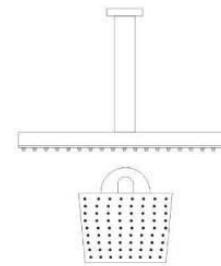

### Multi-function Thermostatic Concealed Shower

#### INSTALLATION Tools You Will Need :



Adjustable wrench



Hexagon wrench



Philips Screwdriver



Pipe Tape



Glue

#### Notes before installation :

1. Please check that all components are available.
2. Before installation ensure that all feed lines are clear of debris and on/off valve is available.
3. Ensure water pressure is between 20-125 PSI (includes combination of hot and cold feed lines).
4. Pictures in the manual are general in content and may not represent exactly your purchased faucet. If you are having difficulties please contact a professional plumber.
5. If you will be away from home for an extended period you should shut off the main water supply.

#### Daily maintenance

1. Use a soft cloth and vinegar to remove hard-water spots.
2. Check aerator (if present) regularly for calcium build up as when water stream is not optimum.
3. DO NOT use caustic cleaning products as the use will break down finish and will void the product warranty.
4. Acceptable cleaners include vinegar or mild non-abrasive liquid detergents.
5. If the water pressure appears to be less than optimum remove, inspect, clean or replace aerator

You need to purchase this accessory to install



◆ Installation step — 3/4 inch inlets 4-way thermostatic shower faucet

<p>1. Confirm the installed place of the pressure balance valve and fixed on the wood block .</p>	<p>2. Connect the hot&amp;cold inlet tube and outlet tube,then make sure the tube fix stable on the wooden wall.</p>	<p>3. Please cut the size of the tile hole according to the size and shape of the protected cover ( about 5mm bigger than the protected cover from each side ).And please put the tile outside the wooden wall ( please noted that we keep the same central point for the tile hole with the protected cover ).</p>
<p>4. Install the water proof cover to the N-box with glue,fix the steel plate, then install the handle levers.</p>	<p>5. Put on the handle,then tight the screw.</p>	<p>6. Wrap the teflon tape on the thread Step,Clockwise rotation of the wall arm to the pipe, the rain shower head connects to the arm.</p>

7

◆ Install the massage shower

Step 1. Wrap the tooth tube NPT1/2 with teflon tape and screw into the wall  
 Step 2. Cut off excess part with a saw  
 Step 3. Cover the decoration cup, then screw the massage shower in

◆ Connection of wires

◆ Install the handheld shower head

Step 1. Screw the thread into the water pipe inside the wall.  
 Step 2. Screw the main body into the thread.  
 Step 3. Rotate and fix with the alien wrench.  
 Step 4. Connect handle holder with hose and handle shower

8

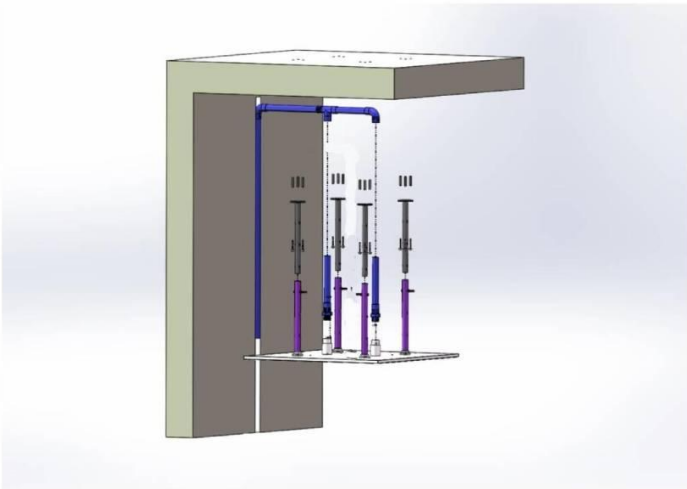
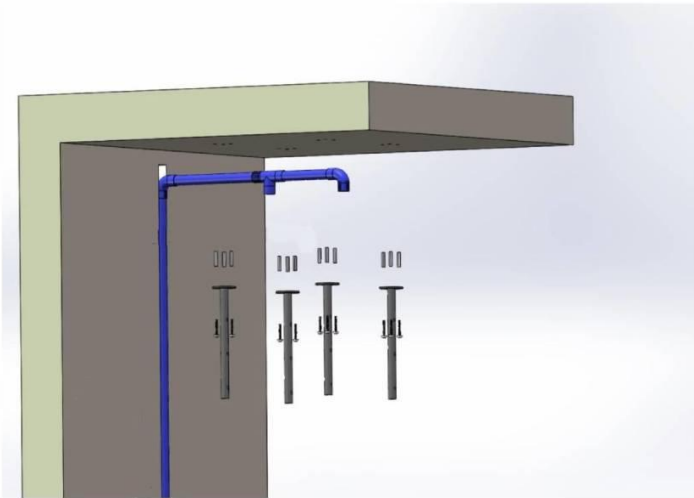

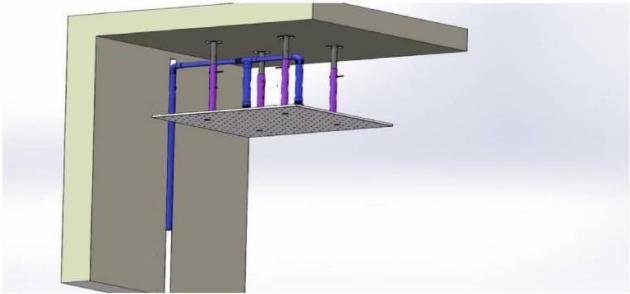
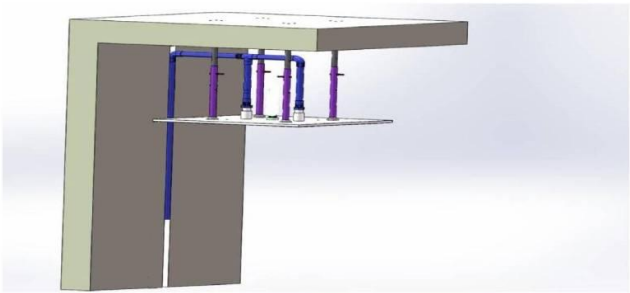
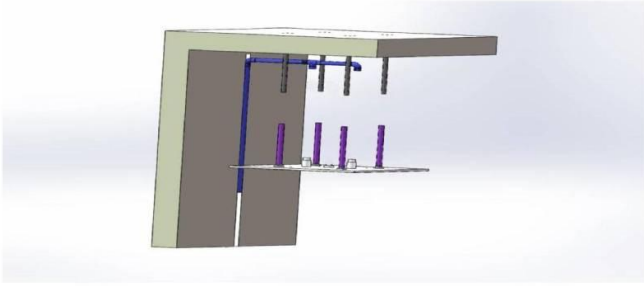

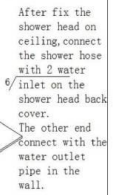
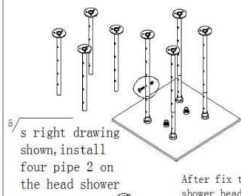
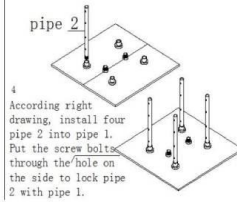
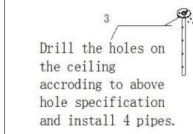
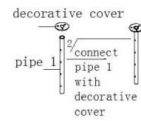
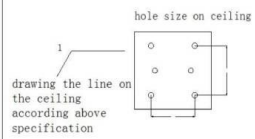
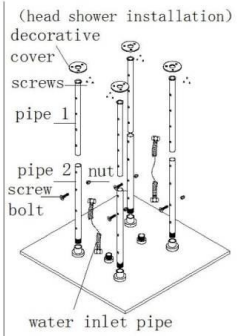

## Showerhead Installation

INSTALLATION MANUAL Tools You Will Need:



Adjustable Wrench



Hexagon wrench

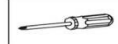

Phillips Screwdriver

### Before the Installation

1. Check the package and confirm all parts are included. If any part is missing or damaged, please contact us.
2. Do not disassemble the main body, as it has been installed & commissioned correctly & precisely before leaving the factory.
3. Shut off the main water supply prior to beginning installation.
4. Do flush the water supply lines to remove any dirt and debris before installation (**IMPORTANT**).
5. Make sure to connect the hot/cold inlet pipe correctly. If standing in front, connect hot water pipe to the left and cold water pipe to the right.
6. After the installation, check for leaks and make sure every joint is safely sealed.

### Cleaning and Maintenance

1. Rinse with clean water and dry with a soft cloth.
2. Do not use any detergent, acid, polisher, abrasives, or harsh cleaners.
3. Do not use cloth with a coarse surface.

### Parts List

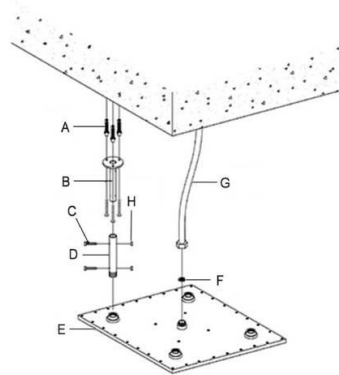

Part	Name	Quantity
A	anchors	16
B	mounting bar	4
C	screws	24
D	shower bar	4
E	shower head	1
F	screen washer	1
G	shower hose	1
H	nut	8

**Installation Guide**

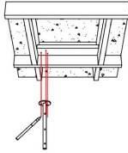

1. Make the fixing positions to ceiling.

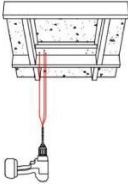

2. Drill holes to suit the anchors.

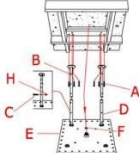

3. Add the screen washer (F). Screw shower hose (G) (not included) to the water inlet on the shower head (E) and then to the water outlet in the ceiling. Install the anchors (A) and fix the mounting bar (B) to ceiling with screws (C). Screw shower bars (D) into the shower head (E) tightly. Attach the shower bar (D) to the mounting bar (B) and fix screws (C) and nut (H) to lock shower bars (D) with mounting bar (B) at the desired height.

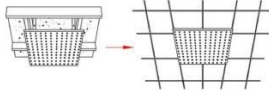

4. Finish the ceiling as shown.

**Troubleshooting**

Problem	Possible Cause	Corrective Action
Water does not shut off completely.	1. O-ring is not seated correctly or worn. 2. Cartridge may be defective.	1. Reseat or replace O-ring. 2. Replace cartridge.
Leaks at waterline connection.	1. Worn or broken washer. 2. Faucet body may be defective.	1. Replace washer. 2. Replace faucet (contact us for the replacement).
Leaks from handle.	1. Cartridge may come loose. 2. Cartridge may be defective.	1. Reseat cartridge tight. 2. Replace cartridge.
Leaks at hose connection.	1. Hose connection is loose.	1. Tighten hose. 2. Replace hose.
Leaks at shower valve connection.	1. Connection may come loose or not sealed completely. 2. Defective shower valve inlet or outlet connector.	1. Check connections. 2. Replace valve body.
Diverter knob does not work.	1. Diverter cartridge may be defective.	1. Replace cartridge.
LED light does not Light or noisy LED showerhead.	1. Defective LED generator.	1. Replace LED spray head (for kitchen faucet). 2. Replace LED threaded pipe (for separate faucet spout). 3. Replace LED generator (for others).
Low flow.	1. Check for water pressure problems. 2. Aerator may be dirty or clogged.	1. Clean or replace the aerator. 2. Remove waterflow restrictor if available. 3. Install booster or pump (if applicable).