

THERMOSTATIC SHOWER Series INSTALLATION GUIDE



6058



6063



6088



6089

Luxury 3-Function Thermostatic Shower System

- 6088 8
Double Shower 3-Function Thermostatic Shower System
- 6089 14
Luxury 4-Function Thermostatic Shower System
- Care and Maintenance 21

♦ Installation Condition

1. Check the Accessories List to verify that all parts are complete in this package.
2. Do not disassemble the main body by yourself.
3. Connect inlet pipes to supply valves.
4. Make sure inlet pipes and supply valves have been installed and cleaned, with no impurities in the pipeline.
5. After installation, check all joints for leakages.
6. Do not leave the rain shower system exposed to a severely corrosive environment.



YOU MAY NEED:



◆ **Luxury 3-Function Thermostatic Shower System**
Model:M6058
PRODUCT LIST

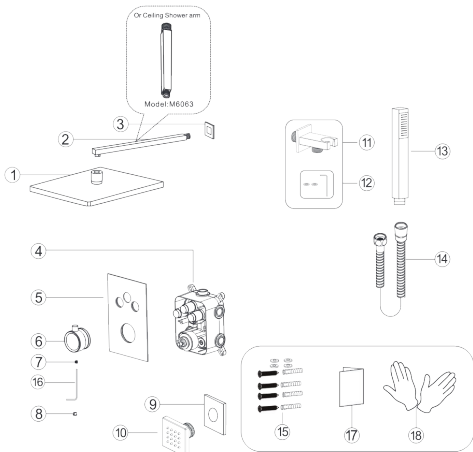

No.	Part name	Qty	No.	Part name	Qty
1	Shower head	1	11	Hand shower holder	1
2	Shower arm	1	12	Holder parts	1
3	Shower arm cup	1	13	Hand shower	1
4	Main body	1	14	Shower hose	1
5	Panel	1	15	Body box fittings	4
6	Handel	1	16	Handle wrench	1
7	Valve screw	1	17	Instruction manual	1
8	Handle cap	1	18	Gloves	2
9	Body jet cup	6			
10	Body jet	6			

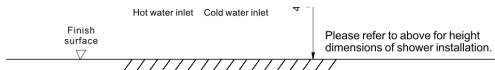

Step 2

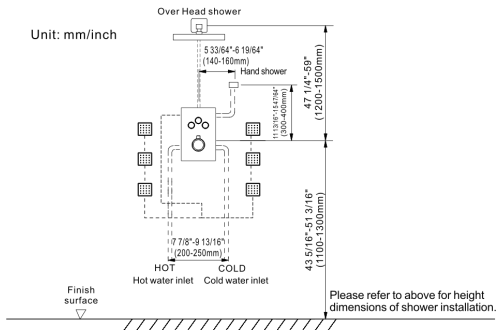

◆ Installation Depth Of Shower Arm & shower holder & body Jet

Unit:mm/inch

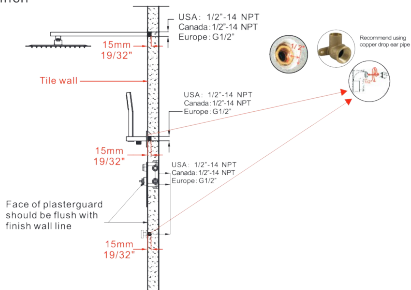

The installation depth of shower arm & shower holder & body jet can't over 19/32" (15mm) so the thickness of tile must be calculated before installation.

◆ Installation Depth of Main Body

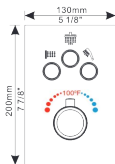

All button can be turned on at the same time and they could be turned on separately too.

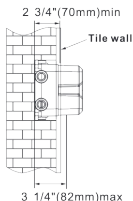

- Notice:**
1. The installation depth of main body should be no less than 2 3/4" (70mm) and no more than 3 1/4" (82mm), including the thickness of tile. Other wise, the panel cannot be installed.
 2. The opening size of ceramic tile shall be smaller than the panel size

◆ Main Body Connecting Pipe Schematic Diagram

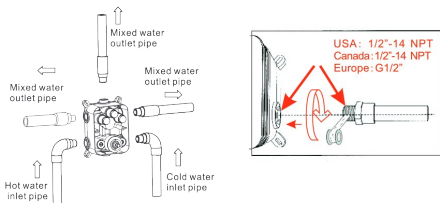

1. Connect the water pipes as illustrations. Please make sure the mark ↑ is facing upward.
2. Before tiling, turn on the water and pull the shower handle to check for leakages.



Warning: must install hot water and cold water inlet strictly as instructions.

◆ Installation Of Rain Shower Head & Shower Arm

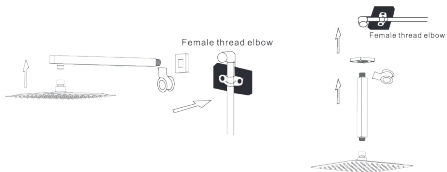

1. Connect shower arm with the cover before screwing arm into riser connection to prevent damage.
2. Fix shower head onto shower arm and apply tape to pipe threads on both ends.
3. Do not overtighten shower head. It is 360° swivel connection.

◆ Main Body valve installation

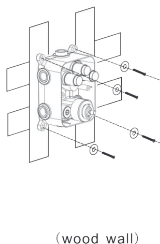
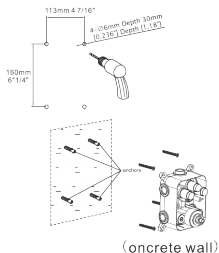

1. Make marks according to the size of the main body valve and then drill anchors into the wall (concrete wall)
2. Lock main body to wood directly with screws (wood wall)

▲ Please note that the level meter should be parallel with the wall, otherwise the panel cannot be installed.

◆ Main Body valve installation

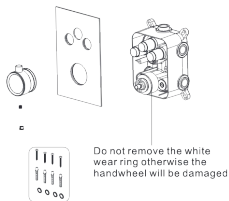

Precautions for handwheel installation

※1: The line can't misplace, it should be kept in a line, otherwise the water temperature of 100 F or 38 C will not be correct.



※2: Please ensure that A Plastic locating ring and B handwheel locating pin kept in the same line with 100 F or 38 C. Otherwise, the water temperature will be wrong.

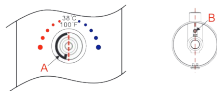

1. Use Valve gasket spare parts and to fixed Main body on the wall and then install Panel.
2. Please fix the main body to the wall remove the plastic protective cover and install panel water diverter screw and water diverter cap step by step.
3. Install the handle with the screw and handle cap.

◆ Body Jets Installation

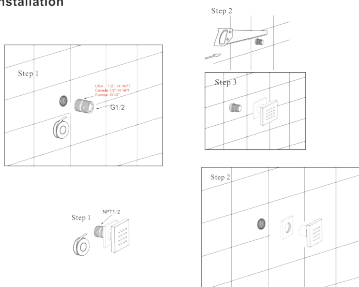

Step 1. Wrap the threaded pipe of NPT1/2 with Teflon tape and screw it into the wall.
Step 2. Cut off excess part with a saw.
Step 3. Screw the massage body jet onto the wall.

◆ Hand Shower Holder Installation

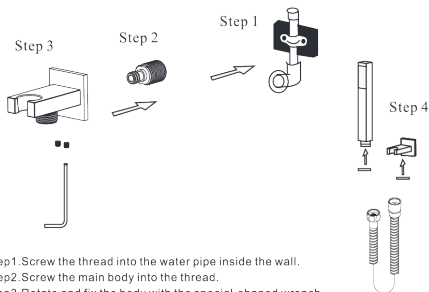

Step 1. Screw the thread into the water pipe inside the wall.
Step 2. Screw the main body into the thread.
Step 3. Rotate and fix the body with the special-shaped wrench.
Step 4. Connect hand shower and the hose.

◆ **Luxury 3-Function Thermostatic Shower System**

Model: M6088

PRODUCT LIST

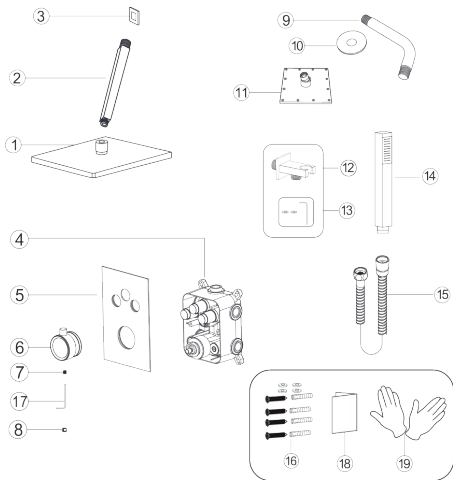

No.	Part name	Qty	No.	Part name	Qty
1	Shower head	1	11	6in Shower head	1
2	Shower arm	1	12	Hand shower holder	1
3	Shower arm cup	1	13	Holder parts	1
4	Main body	1	14	Hand shower	1
5	Panel	1	15	Shower hose	1
6	Handel	1	16	Body box fittings	4
7	Valve screw	1	17	Handle wrench	1
8	Handle cap	1	18	Instruction manual	1
9	Shower arm		19	Gloves	2
10	Shower arm cup	1			

◆ Essential Dimensions

Unit: mm/inch

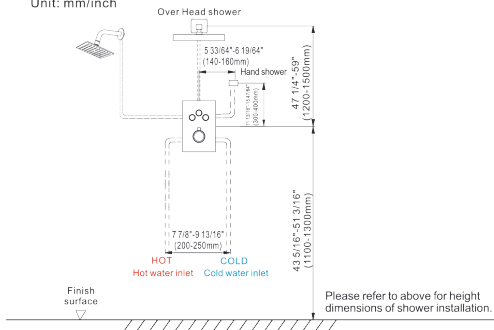

◆ Installation Depth Of Shower arm&shower Holder&body Jet

Unit:mm/inch

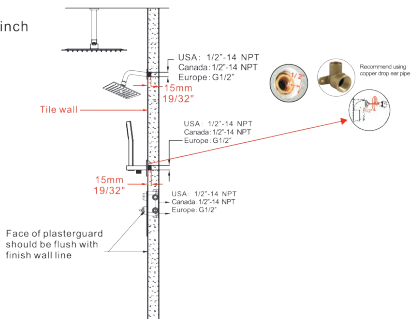

The installation depth of shower arm & shower holder & body jet can't over 19/32"(15mm) so the thickness of tile must be calculated before installation.

◆ Installation Depth of Main Body



All button can be turned on at the same time and they could be turned on separately too.

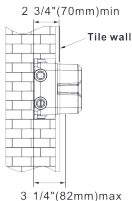

Notice: 1. The installation depth of main body should be no less than 2 3/4" (70mm) and no more than 3 1/4" (82mm), including the thickness of tile. Otherwise, the panel cannot be installed.

2. The opening size of ceramic tile shall be smaller than the panel size

◆ Main Body Connecting Pipe Schematic Diagram

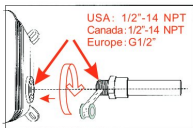
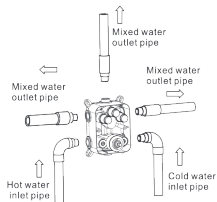

1. Connect the water pipes as illustrations. Please make sure the mark ↑ is facing upward.
2. Before tiling, turn on the water and pull the shower handle to check for leakages.



Warning: must install hot water and cold water inlet strictly as instructions.

◆ Main Body valve installation

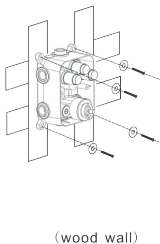
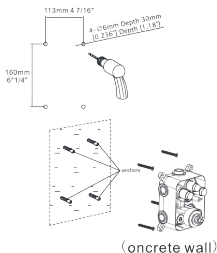

1. Make marks according to the size of the main body valve and then drill anchors into the wall (concrete wall)
 2. Lock main body to wood directly with screws (wood wall)
- ▲ Please note that the level meter should be parallel with the wall, otherwise the panel cannot be installed.

◆ Main Body valve installation

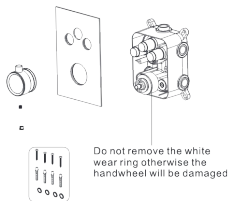

Precautions for handwheel installation

※1: The line can't misplace, it should be kept in a line, otherwise the water temperature of 100 F or 38 °C will not be correct.



※2: Please ensure that A Plastic locating ring and B handwheel locating pin kept in the same line with 100 F or 38 °C. Otherwise, the water temperature will be wrong.

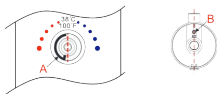

1. Use Valve gasket spare parts and to fixed Main body on the wall and then install Panel.
2. Please fix the main body to the wall remove the plastic protective cover and install panel water diverter screw and water diverter cap step by step.
3. Install the handle with the screw and handle cap.

◆ Body Jets Installation



Step 1. Wrap the threaded pipe of NPT1/2 with Teflon tape and screw it into the wall.
Step 2. Cut off excess part with a saw.
Step 3. Screw the massage body jet onto the wall.

◆ Hand Shower Holder Installation

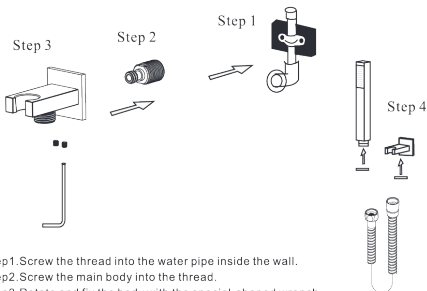

Step 1. Screw the thread into the water pipe inside the wall.
Step 2. Screw the main body into the thread.
Step 3. Rotate and fix the body with the special-shaped wrench.
Step 4. Connect hand shower and the hose.



1. Connect shower arm with the cover before screwing arm into riser connection to prevent damage.
 2. Fix shower head onto shower arm and apply tape to pipe threads on both ends.
 3. Do not overtighten shower head. It is 360° swivel connection.
-

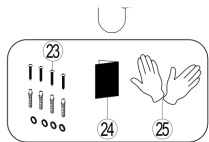
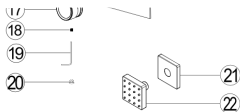

No.	Part name	Qty	No.	Part name	Qty	No.	Part name	Qty
1	Expansion screws	4	10	Shower head body	1	19	Handle wrench	1
2	Inwall box	1	11	Shower hand	1	20	Handle cap	1
3	Waterinlet	3	12	Hand show holer	1	21	Body jet cup	6
4	Cover	1	13	Holder parts	1	22	Body jet	6
5	Screw	2	14	Shower hose	1	23	Valve gasket spare parts	4
6	S8 Allen key	1	15	Main body	1	24	Instruction manual	1
7	Flange	1	16	Panel	1	25	Gloves	2
8	Allen key 2.5	1	17	Handle	1			
9	M4 screw	2	18	Screw	1			

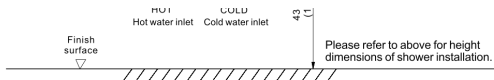

Step 2

Unit: mm/inch

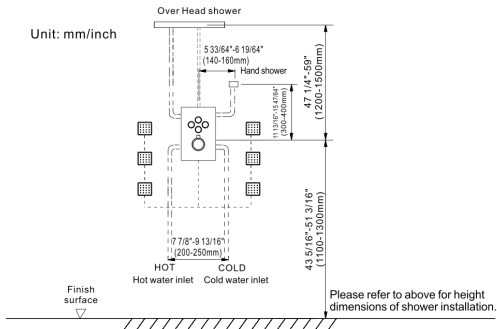

◆ Installation Depth Of Shower Holder & Body Jet

Unit:mm/inch

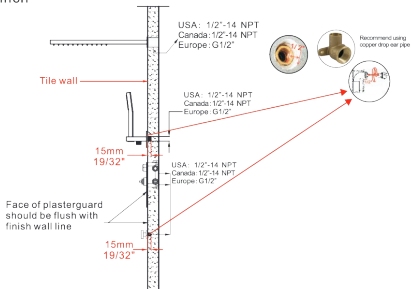

The installation depth of shower holder & body jet can't over 19/32"(15mm) so the thickness of tile must be calculated before installation.

◆ Installation Depth of Main Body



All button can be turned on at the same time and they could be turned on separately too.

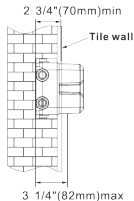

Notice: 1. The installation depth of main body should be no less than 2 3/4"(70mm) and no more than 3 1/4"(82mm), including the thickness of tile. Other wise, the panel cannot be installed.

2. The opening size of ceramic tile shall be smaller than the panel size

◆ Main Body Connecting Pipe Schematic Diagram

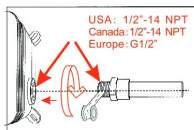
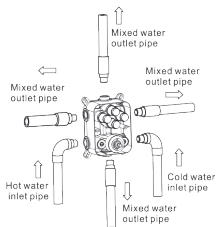

1. Connect the water pipes as illustrations. Please make sure the mark ↑ is facing upward.
2. Before tiling, turn on the water and pull the shower handle to check for leakages.



Warning: must install hot water and cold water inlet strictly as instructions.

◆ Main Body valve installation

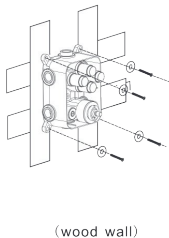
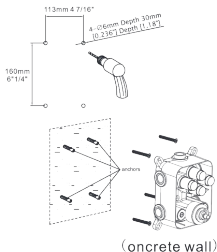

1. Make marks according to the size of the main body valve and then drill anchors into the wall (concrete wall)
2. Lock main body to wood directly with screws (wood wall)

▲ Please note that the level meter should be parallel with the wall, otherwise the panel cannot be installed.

◆ Main Body valve installation

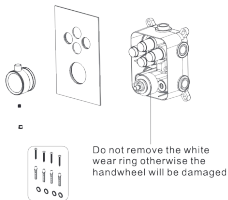

Precautions for handwheel installation

※1: The line can't misplace, it should be kept in a line, otherwise the water temperature of 100 F or 38 C will not be correct.



※2: Please ensure that A plastic locating ring and B handwheel locating pin kept in the same line with 100 F or 38 C. Otherwise, the water temperature will be wrong.

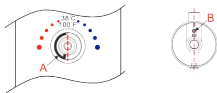

1. Use Valve gasket spare parts and to fixed Main body on the wall and then install Panel.
2. Please fix the main body to the wall remove the plastic protective cover and install panel water diverter screw and water diverter cap step by step.
3. Install the handle with the screw and handle cap.

5. Install Flange as picture.
Caution: do setp 4-5-6 to test horizontal and vertical position of shower head before wall seal to avoid any trouble of repair after wall seal.

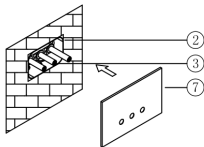

6. Push shower head body into according water inlets, and tighten shower body by M4 screw with Allen key 2.5.

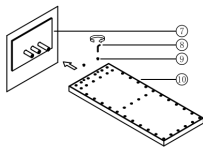

◆ Body Jets Installation

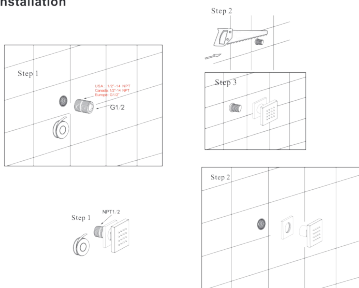

Step 1. Wrap the threaded pipe of NPT1/2 with Teflon tape and screw it into the wall.
Step 2. Cut off excess part with a saw.
Step 3. Screw the massage body jet onto the wall.

◆ Hand Shower Holder Installation

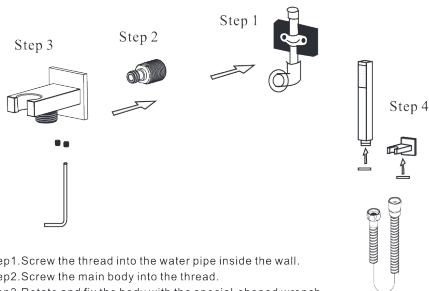

Step 1. Screw the thread into the water pipe inside the wall.
Step 2. Screw the main body into the thread.
Step 3. Rotate and fix the body with the special-shaped wrench.
Step 4. Connect hand shower and the hose.

◆ **IF A LARGE-SCALE CLEAN-UP IS NECESSARY, FOLLOW THESE PROCEDURES:**

1: Use clean water and soft cloth to remove dirt on the surface as much as possible.

2: Use one of the following cleaners to remove dirt on the surface

Mild liquid cleaner.

Colorless glass cleaner, powder cleaner which does not have abrasive function and can be dissolved completely.

Polish liquid which does not have abrasive function.

3: After cleaning, remove the cleansing agent with clean water completely and wipe with soft cotton cloth.

