

BD.Veterinary

Air filled Equine Mattresses and Positioning Aids

Product details and price list

The BD.VET inflatable equine mattress and positioning aid range of equipment provides safe, easy to deploy, supportive working surfaces for surgery and imaging. Correct positioning and cushioning are vital to minimise the risk of post-anaesthetic myopathy and these products give veterinary practitioners close control on the positioning and support of animals in their care. The level of inflation of different elements can be used to bring the patient into the ideal position for the procedure to be conducted.

The range comprises two fully independent pneumatic tables and three designs for table top use. The standard sizes offered will fulfil most requirements, but items may also be made in bespoke sizes. The equipment has its origins in the Snell Veterinary Systems Infla-Table range that has been in use in equine veterinary facilities for many years.

The equipment can be rapidly inflated when required and deflated for storage and transport. Chambers are inflated using a mains electrical pump available in 240v and 110v options, which will fill the main elements in around three minutes per section. The modular nature of their construction means that damage to one element does not write off the equipment and replacement components can be supplied. Each piece of equipment is highly adaptable in the shape that can be deployed, using press studs to allow the set up to be tailored to the specific animal being treated and table being used, where relevant. All styles of mattress can be deployed in both dorsal and lateral configurations. Fittings are MRI and CT imaging safe.



Contact Details

Dru Ross +44 1491 818460 info@BDBCo.VET

All prices indicated here exclude VAT, customs charges where relevant and shipping

Model - OTU

This universal kit is designed for use with powered tables with side panels. Slight variations in component size are offered for no additional cost in order that it will fit most modern operating tables on the market. The elements included enable both dorsal and lateral arrangements. The cushions for table side panels are secured by press stud and a large range of positioning is possible to ensure they sit centrally on the side panels of table being used. The spine cushion is 18cm deep when fully inflated.

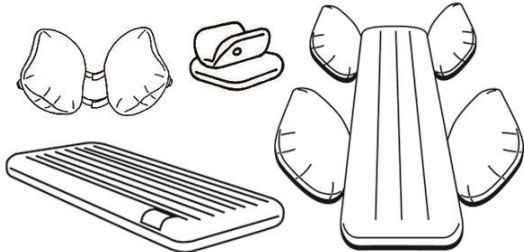
OTU Universal operating table kit comprises:	Illustration of elements	Price (£)
<ul style="list-style-type: none"> • A spine cushion 50cm wide, either 210 or 200cm long • Four adjustable flat cushions for side panels, either 50 x 40cm or 50 x 50cm. (RTC-2) • One lateral mattress 140cm wide and either 200 or 210cm long • One pair of withers cushions (WSC) • A head cushion assembly comprising V cushion with base cushion for the dorsal position and with it removed, for the lateral set up. 76cm long by 58cm wide. (DHC) 		2780
Spares and replacement elements		
OTU Dorsal only- spine cushion 50cm wide, either 210 or 200cm long & four side panel cushions (50 x 50cm or 50 x 40cm)		1200
OTU Lateral only mattress (140 x 200 or 210cm)		930

Model - FTS

The FTS mattress system is for small flat tables, typically 100cm wide with side structures or panels for lateral placement. The principal element has two side bumpers for dorsal placement. To deploy laterally, the bumper cushions are deflated and the whole mattress is turned over. The head and flat cushions are then arranged as illustrated.

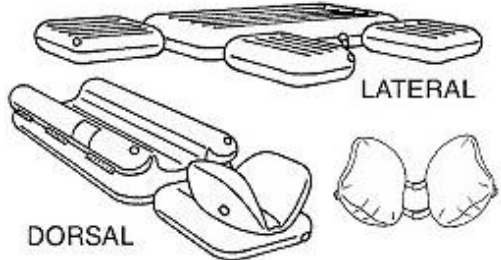
FTS Flat operating table kit small comprises:	Illustration of elements	Price (£)
<ul style="list-style-type: none"> • A cushion 74 wide, and 213cm long with inflatable bumpers for dorsal placement • Three adjustable flat cushions for left or right lateral placement 76 x 58cm (RTC-1) • One pair of withers cushions (WSC) • A head cushion assembly comprising V cushion with base cushion for the dorsal position and with it removed, for the lateral set up. 76cm long by 58cm wide (DHC). 		2570

Spares and replacement elements		
Cushion with side bumpers only		1500

Model - FTL

This model is designed for use on flat tables with or without insets, making it extra flexible. The principal cushion is H-shaped comprising a base layer and a top cushion comprising three elements, the central one which is inflated for lateral placement and deflated for dorsal. To complete the lateral set up, a double depth infill cushion is positioned at the inset of the H. The whole structure is 36cm deep, providing greater levels of support than the FTS.

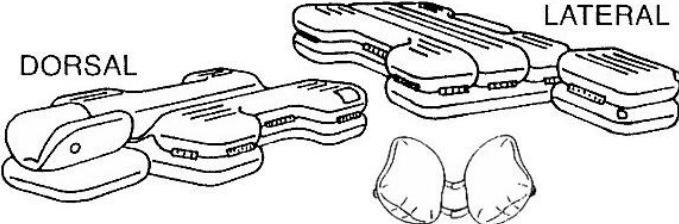
FTL Flat operating table kit large comprises:	Illustration of elements	Price (£)
<ul style="list-style-type: none"> • Two tier H-shaped cushion • One infill side cushion, two tier • One pair withers cushions (WSC) • A head cushion assembly comprising V cushion with base cushion for the dorsal position, 76cm long by 58cm wide. (DHC) • Two tier rectangular head cushion for lateral placement (RTC-3) 		3800
Spares and replacement elements		
H shaped two tier main cushion assembly		2610
Single tier, three section top cushion assembly		1300
Central infill cushion (one tier)		345
Side infill cushion (two tier)		345

Model - IVEM-1

A fully independent operating table with support frame and integral head support that can be used in the field, stable or practice. The table comprises four layers (dorsal set up) or five layers (lateral set up) each of which inflates independently ensuring that there will be no catastrophic collapse due to puncture or valve failure. These are secured together by press studs and are supplied ready stacked. If desired, one layer need not be inflated to accommodate different heights of personnel.

Patients are rolled or lifted on to the uninflated surface of the table and each layer is inflated individually, commencing from the bottom. Time to deploy from the carry case to the dorsal configuration is around 15 minutes, with an experienced operator.

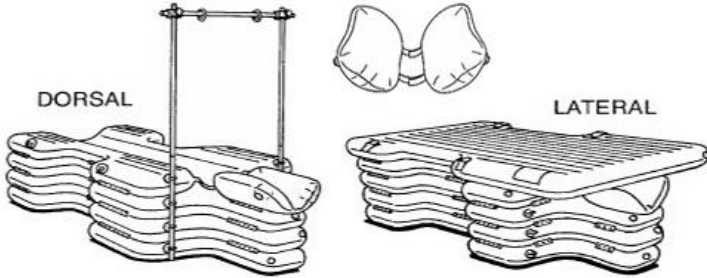
IVEM-1 Independent lifting table kit comprises:	Illustration of elements	Price (£)
<ul style="list-style-type: none"> • IVEM-1 Dorsal lifting table (279 x 142 cm) • IVEM-1 Lateral table top (272 x 163 cm) • One pair withers cushions (WSC) • Limb support kit (LSK) • Carry case (CYC) 		7200
Spares and replacement elements		
Replacement dorsal top cushion		1520
Replacement lift mid-section		1270

Model - IVEM-2

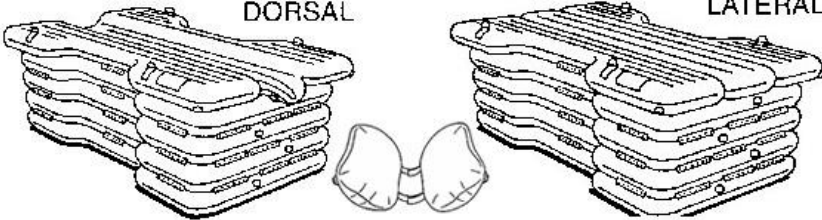

This fully independent lifting table can be used in the field, shed or practice space. It is a simpler option than the IVEM-1, as it does not offer the limb support and the access to the head and neck area is reduced compared with the IVEM-1. The top section comprises three cushions, the central one of which is inflated when the table is to be deployed in the lateral configuration. The sections are secured together by press studs and are supplied ready stacked. If desired, one layer need not be inflated to accommodate different heights of personnel.

Patients are rolled or lifted on to the uninflated surface of the table and each layer is inflated individually, commencing from the bottom. Time to deploy from the carry case to the dorsal configuration is around 15 minutes, with an experienced operator.

IVEM-2 Independent lifting table kit comprises:	Illustration of elements	Price (£)
<ul style="list-style-type: none"> • Five tier lifting table with three section top cushion for dorsal and lateral configurations • One pair withers cushions (WSC) • Carry case (CYC) 		6120
Spares and Replacement Elements		
Replacement three section top cushion		1460
Replacement lifting mid-section cushion		1060

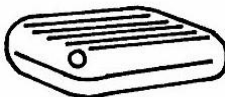

Accessories

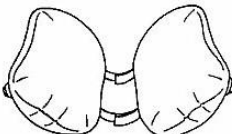
A range of the small cushion elements are available as spares or replacements.

Product code	Description	Product image	Price (£)
DHC	Dorsal head cushion set comprising V support cushion and flat base		325
DHC-1	Head cushion top V-section		170
DHC-2	Head cushion base (76 x 58 x 18cm)		170
RTC-1	Rectangular cushion for FTS (76 x 58 x 18cm)		150
RTC-2	Rectangular cushion for OTU (50 x 50 or 50 x 40cm)		140
RTC-3	Rectangular cushion – double depth for FTL (76 x 58 x 36cm)		350
WSC	Withers cushion 60cm long 30cm diameter		350
LSR	Inflatable Limb Separator – 60cm long x 40cm diameter		420
	Bravo GE OV10 inflator (230v or 110v)		98
LSK	Limb support kit for IVEM-1 Stainless steel adjustable frame that floor stands and is positioned through D rings on the table sections, with clamp blocks and tie rings for securing limbs safely		790
CYC	Carry Case (for IVEM-1 and IVEM-2)		185

Bespoke service – custom made cushions for surgery tables

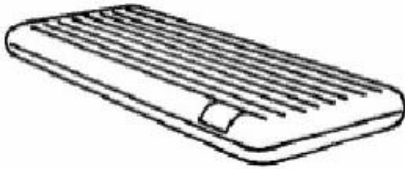
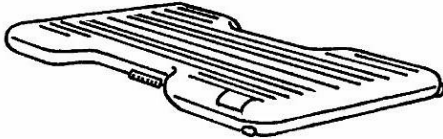
A bespoke service is available for all the products listed here. We are also able to develop specific products as required. The table below gives an indication of the scale of cost for bespoke items. As standard, each element is 18cm deep, hence those comprising two tiers will be 36cm deep. Other depths can also be supplied as required. Bespoke mattresses can be made to fit your CT and MRI imaging tables.

Product code	Description	Product Image	Minimum charge plus price per m² (£)
B1	Single tier rectangular cushion		100 316
B2	Single tier H shaped cushion		150 360
B3	Two tier rectangular cushion		POA
B4	Two tier H shaped cushion		POA

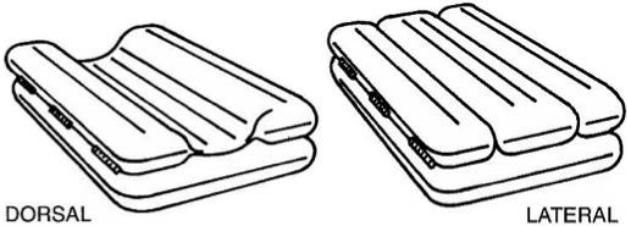
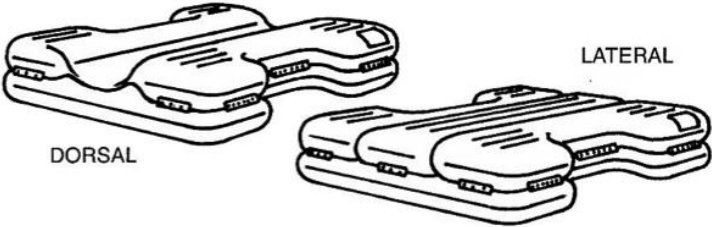
B5	Two tier rectangular cushion with deflatable central trough for dorsal positioning	 <p>The diagram shows two views of a two-tier rectangular cushion. The left view is labeled 'DORSAL' and shows a central trough. The right view is labeled 'LATERAL' and shows the side profile of the two tiers.</p>	POA
B6	Two tier H shaped cushion with deflatable central trough for dorsal positioning	 <p>The diagram shows two views of a two-tier H-shaped cushion. The left view is labeled 'DORSAL' and shows the H-shaped profile with a central trough. The right view is labeled 'LATERAL' and shows the side profile of the two tiers.</p>	POA

Product Specifications

Materials

Cushions are made from heavy duty nylon reinforced polyurethane. Seams are radio-frequency welded ensuring a robust bond, tested to 5psi in the factory. They are highly resistant to abrasion, puncturing, most acids, alkalis, solvents and oils. The fabric is highly UV resistant, will not support microbial growth and will tolerate strong disinfection. Each chamber has a self-closing fill/deflate valve with screw cap.

Load bearing

Mattresses are designed to accommodate loads up to 2500 kgs (5500lbs), well above the weight of any animal likely to be able to be accommodated on the surface provided by the mattresses.

Inflation

The supplied pump is of appropriate specification for the equipment. Mattresses should not be inflated above 3.5psi. Higher inflation will create an inappropriate working surface for veterinary use and may weaken the welded seams of the equipment.

Warranty

A warranty of five years or 1000 inflations is provided in the expectation that the equipment will be used only for the purpose for which it is designed, namely veterinary procedures on large animals. Their use for the lifting of vehicles or any other loads not in keeping with their design purpose will render the warranty invalid. Questions concerning the suitability of the equipment for a specific purpose should be directed to the email below.

Equipment maintenance: Wash equipment prior to and following use with water and medical grade disinfectant. If not in regular use, it is suggested that cushions are inflated every four to six weeks to ensure they are working order when they are required.

Dimensions in cm (inches)

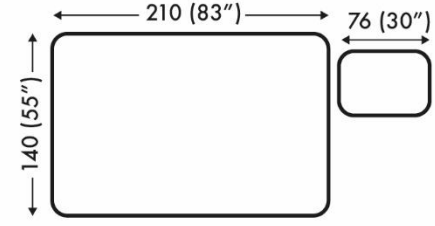
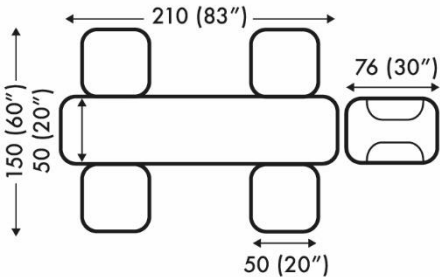
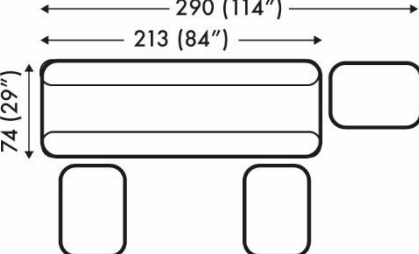
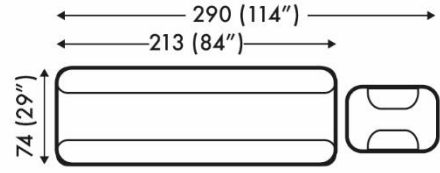
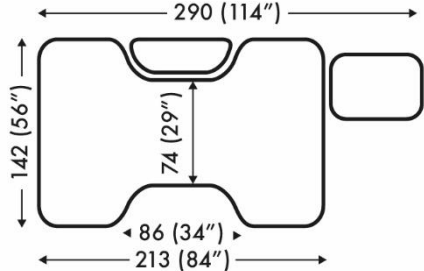
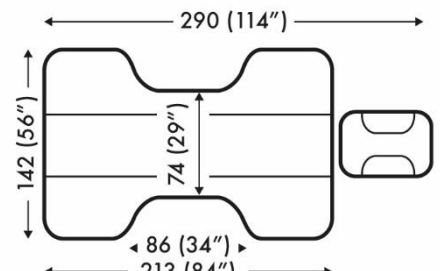
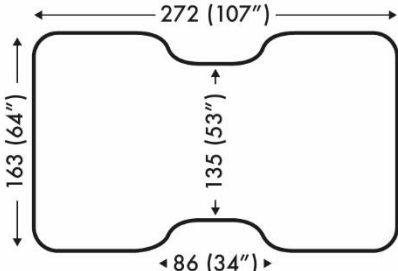
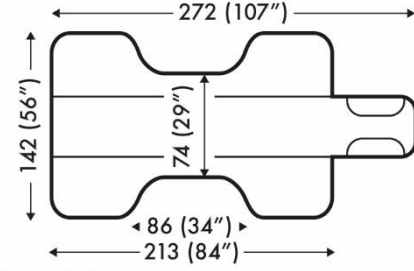
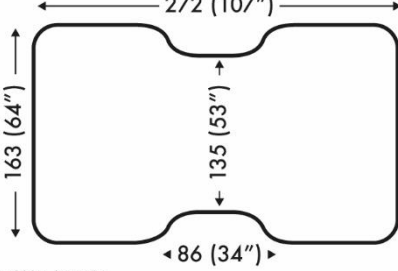
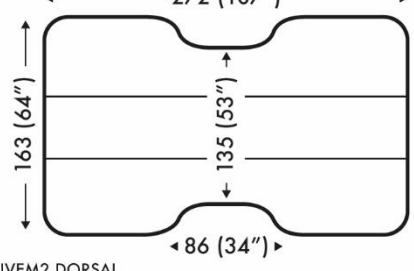
Model	Lateral mode – plan view	Dorsal mode plan view
OTU	 <p>OTU LATERAL</p>	 <p>OTU DORSAL</p>
FTS	 <p>FTS LATERAL</p>	 <p>FTS DORSAL</p>
FTL	 <p>FTL LATERAL</p>	 <p>FTL DORSAL</p>
IVEM-1	 <p>IVEM1 LATERAL</p>	 <p>IVEM1 DORSAL</p>
IVEM-2	 <p>IVEM2 LATERAL</p>	 <p>IVEM2 DORSAL</p>
Height (cm / inches)	<p>Lateral 89 cm (35") Dorsal to the bottom of the trough 53cm (21")</p>	<p>Lateral 89 cm (35") Dorsal to the bottom of the trough 71cm (28")</p>