

DIGITAL MULTIMETER

User's Manual

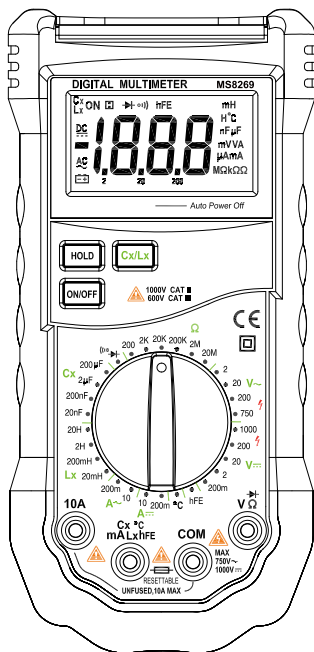

CAT II
1000V

CAT III
600V

DIGITAL MULTIMETER

Content

1. Overview	1
1.1 Safety Information.....	1
1.1.1 Safety instructions.....	1
1.1.2 Safe operation habits.....	1
1.1.3 Safety symbols.....	3
1.1.4 Safe maintenance habits.....	3
1.2 Input protecting measures.....	4
2. Descriptions of meter exterior	5
2.1 Exterior of the meter.....	5
2.2 LCD.....	6
2.3 Function keys.....	7
2.4 Input sockets.....	7
3. Instructions for operation	8
3.1 Routine operation.....	8
3.1.1 Mode of data holding.....	8
3.1.2 Energy saving function of the battery.....	8
3.2 Instructions for measurement.....	8
3.2.1 Measurement AC and DC voltages.....	8
3.2.2 Measuring resistance.....	9
3.2.3 Diode measurement.....	10
3.2.4 Continuity measurement.....	10
3.2.5 Measuring capacitance.....	11
3.2.6 Transistor measurement.....	12
3.2.7 Measuring inductance.....	12
3.2.8 Measuring temperature.....	13
3.2.9 Measuring current.....	13
4. Technical parameters	14
4.1 General parameters.....	14
4.2 Precision parameters.....	15

DIGITAL MULTIMETER

Content

4.2.1 DC voltage.....	15
4.2.2 AC voltage.....	15
4.2.3 Transistor.....	16
4.2.4 Resistor.....	16
4.2.5 Diode.....	16
4.2.6 Continuity.....	17
4.2.7 Capacitance.....	17
4.2.8 Inductance.....	17
4.2.9 Temperature.....	17
4.2.10 DC current.....	18
4.2.11 AC current.....	18
5. Meter maintenance	18
5.1 Routine maintenance.....	19
5.2 Replacing the probe.....	19
5.3 Replacing the battery.....	19
6. Accessories	20

DIGITAL MULTIMETER

1. Overview

The multimeter is a small, safe and reliable 3 digit handheld auto ranging multimeter. This meter can measure AC/DC voltage, AC/DC current, resistance, diode, capacitance, inductance, Continuity and temperature. This tool is ideal for professionals and hobbyists alike. For the internationally-accepted symbols used in related instruments and instruction manuals, please refer to instructions in Section 1.1.3.

1.1 Safety Information

1.1.1 Safety Instructions

- When using this meter, the user shall comply with all standard safety regulations related with the following two aspects :
 - Safety regulations on avoiding electric shock.
 - Safety regulations on avoiding operating instruments wrongly.
- To ensure your safety, please use the test tips supplied with the meter. Check them and make sure that they are in good condition before using.

1.1.2 Safe operation habits

- If the meter is used nearby equipments with significant electromagnetic interference, the readings from the meter would become unstable, and even significant error might occur.
- In case the exterior of the meter or the test tip is broken, please do not use them.
- If the instructions of meter operation in the manual are not followed, the safety functions provided by the meter might not be effective.
- Be extremely careful when working nearby naked conductors or bus.
- Never use this meter nearby explosive gas, vapor, or dust .
- Use this meter to measure known voltages, in order to make sure if the meter works properly. In case that the meter behaves abnormally, please do not use it, because the protection devices might have been damaged. If you have any doubt that something is wrong with the meter, please send it for service.
- Input terminals, functions, and ranges must be chosen properly in order to conduct measurements.
- If the range of the signal to be measured is hard to ascertain , please turn the range selection switch to the position of the maximum range.

DIGITAL MULTIMETER







- The input value should never exceed the threshold input value defined by the range, otherwise the meter can be damaged.
- When the meter is connected to the circuit to be measured, please never touch the input ends which are not in use .
- If the voltage to be measured exceeds 60Vdc (effective voltage) or 30Vac (effective voltage), please operate carefully to prevent electric shock.
- When conducting measurements with the test tips, please first connect the black (common) test tip to the common terminal of the circuit to be measured, then connect the red test tip to the measuring end of the circuit to be measured; After the measurement is completed, please first disconnect the red test tip, then the black (common) test tip.
- Please make sure that the measuring tips are not connected to the circuit to be measured, before switching the measuring range. the circuit to be measured, before switching the measuring range.
- For range selection related with all DC functions, including both manual or automatic range selection, in order to prevent the danger of electric shock resulted from possible incorrect reading, please first use AC function to make sure if there is any AC voltage, then select a DC voltage range which is equal to or greater than the AC range .
- Before conducting measurements on resistors, diodes, or capacitors or conducting ON/OFF test, please turn off the power of the circuit to be measured, and discharge all the high-voltage capacitors in the circuit to be measured .
- Never conduct resistance measurements or ON/OFF test on circuits which is powered on .
- Please check the fuse of the meter before conducting any current measurements. Please turn off the power of the circuit to be measured before connecting the meter to this circuit .
- When repairing a TV set or conducting measurements on power conversion circuit, please pay attention to high voltage pulses from the circuit to be measured, and use the filters of the TV set to weaken these pulses in order to prevent the meter from being damaged.
- This meter is powered by a 9V 6F22 battery. Please install the battery properly in the battery case of the matter .
- If a battery indication symbol  appears, please replace the battery immediately. Battery with low energy level will result in wrong meter

DIGITAL MULTIMETER

- readings, which might result in electrical shock or physical hurting .
- When conducting voltage measurements of category II, the voltage should never exceed 1000V; When conducting voltage measurements of category III, the voltage should never exceed 600V.
 - If the shell (or part of the shell) of the meter is taken off, please do not use the meter .

1.1.3 Safety symbols:

the following are symbols used on the surface of the meter and/or in the instruction manual :

	Important safety information. Refer to the instruction manual before using. Improper operation might result in damaging the equipment or its parts .
	Alternating Current
	Direct Current
	Earth
	Double insulation protection
	Fuse
CAT II	It is applicable to test and measuring circuits connected directly to utilization points (socket outlet sand similar points) of the low-voltage MAINS installation.
CAT III	It is applicable to test and measuring circuits connected to the distribution part of the building's low-voltage MAINS installation.

1.1.4 Safe maintenance habits

- Always pull out the measuring tips before opening up the shell of the meter or taking off the battery cover.
- Always using designated spare parts and components when repairing the meter .
- Please turn off all related power supply, and make sure that you are not carrying static charge before taking off the shell or part of the shell of the meter, in order to avoid damaging parts of the meter.
- Only technicians who have complete knowledge of the meter and

DIGITAL MULTIMETER

the danger of electrical shock are permitted to perform the following operations: meter calibration, maintenance, and service, etc..

- After taking off the shell of the meter, please always keep in mind that there is still danger from high voltage of some of the capacitors in the meter even if the power of the meter is turned off.
- In case that anything abnormal is observed for the meter, please stop using it immediately and send it for service. Please make sure that this meter can not be used before it passes the quality inspection again .
- If the meter is not to be used for a long period of time, please take off the battery, and keep it away from high temperature and high humidity .

1.2 Input protecting measures

- When conducting voltage measurements (excluding the range of 200mV), the highest input voltage allowed is DC 1000V or AC 750V. (for the range of 200mV, the highest input voltage allowed is AC 250V or equivalent effective voltages)
- When conducting measurements on resistor and diodes or conducting ON/OFF tests, the meter can withstand AC voltages not exceeding 250V or equivalent effective voltages.
- When measuring capacitance, inductance, temperature, or mA level of current, or conducting hFE tests on transistors, protect the meter with the self-recovery fuse (F500mA/250V)

DIGITAL MULTIMETER

2. Descriptions of meter exterior

2.1 Exterior of the meter

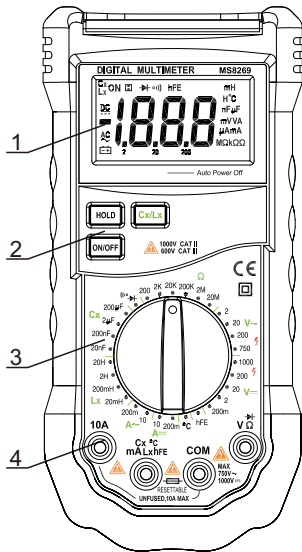

1. LCD 2. Function Keys 3. Rotary switch 4. Input socket

DIGITAL MULTIMETER

2.2 LCD

Please refer to Table 1 for information related with the display

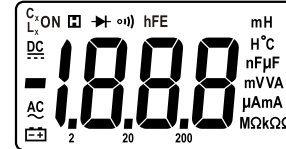

Fig. 1 Display

Table 1 Displayed symbols

Symbol	Meaning
	Battery level is low ⚠ In order to avoid electric shock or physical hurting due to wrong readings, please replace the battery as soon as possible when the low-voltage symbol for the battery appears.
~	Indicating negative input polarity
AC	Indicating AC input . Alternating voltage or current is measured as the mean value of the absolute value of the input . Calibrate and output the equivalent mean squared root value of the sine wave.
DC	Indicating DC input.
	The meter is under the mode of diode measurement.
C _x , ON	The meter is under the mode of capacitance, and inductance measurement.
o)	The meter is under the mode of ON/OFF test.
H	The meter is under the mode of date holding.
°C	°C:degree Celcius. Unit of temperature.
V, mV	V: Volt. Unit of voltage. mV: milli volt. 1×10^{-3} or 0.001 Volt.
A, mA	A: Ampere. Unit of current. mA: milli ampere. 1×10^{-3} or 0.001 ampere.

DIGITAL MULTIMETER

Table 1 Displayed symbols (Continued)

Ω, kΩ, MΩ	Ω: Ohm. Unit of resistance. KΩ: Kilo Ohm. 1×10^3 or 1000 Ohm. MΩ: Mega Ohm. 1×10^6 or 1, 000, 000 Ohm.
mH, H	H: Henry. Unit of inductance. mH: Milli henry. 1×10^{-3} or 0.001 henry.
μF, nF	F: farad. Unit of capacitance. μF: micro farad. 1×10^{-6} or 0.000001 farad. nF: Nano farad. 1×10^{-9} or 0.000000001 farad.

2.3 Function Keys

Please refer to Table 2 for information related with function Keys.

Table 2 Function Keys

Key	Function	Operation descriptions
ON/OFF	Switch at any position.	Turn the power of the meter on or off
HOLD	Switch at any position.	Press HOLD key to switch to or quit from the data holding mode.
LX/CX	Capacitance, inductance	Press LX/CX key to connect to the circuit for measuring capacitance or inductance.

2.4 Input sockets

Please refer to Table 4 for information related with the measuring terminals.

Table 4 Input sockets

Input sockets	Descriptions
COM	The common input terminal for all measurements (to be connected to the black measuring tip or the common output plug of the dedicated multi-functional test socket)
→ VΩ	Positive input terminal for voltage, resistance, and diode measurements or humming ON/OFF test (to be connected to the red measuring tip).

DIGITAL MULTIMETER

Cx°C mALxhFE	Positive input terminal for measuring current (mA), capacitance, inductance, temperature, and hFE of transistors (to be connected to the red measuring tip or “+” output plug of the dedicated multi-functional test sockets).
10A	Positive input terminal for 10A current (to be connected to the red measuring tip)

3. Instructions for operation

3.1 Routine operation

3.1.1 Mode of data holding

The current read value can be kept on the display under the mode of data holding. the mode of data holding can be quit by changing the selection of measuring function , or pressing **HOLD** key once more.

To set or cancel the mode of data holding :

1. Press “**HOLD**” key once, the current read value will be kept on display, and in the mean time the “” symbol will be displayed on LCD .
2. Press “**HOLD**” key once more to return the mode of the meter to the normal measuring mode.

3.1.2 Energy-saving function of the battery

The meter will automatically turn off the power 30 minutes after it is turned on, so that the energy of the battery is saved.

3.2 Instructions for measurement

3.2.1 Measuring AC and DC voltages

 **WARNING**

Do not measure voltages higher than DC 1000V or AC 750V (effective value), to prevent electric shock and/or damaging the meter. Do not apply voltages higher than DC 1000V or AC 750V (effective value) between the common terminal and earth to prevent electric shock and /or damaging the meter .

Voltage is the difference of potentials between two points.

The polarity of AC voltage changes with time, while that of DC voltage does not change.

DIGITAL MULTIMETER

The ranges for DC voltage of this meter are: 200.0mV, 2.000V, 20.00V, 200.0V, and 1000V;
The ranges for AC voltage are: 2.000V, 20.00V, 200.0V, and 750V.

Attention:

With the measuring ranges of DC 200mV and AC 2V, the meter will display a certain value even though the measuring tips are not connected. In this case, short out the “V- ” AND “COM” ends for a second to make the displayed value of the meter to zero.

3.2.2 Measuring resistance

WARNING

To prevent the meter or the equipment to be tested from being damaged, always turn off all power supplies of the circuit to be tested and discharge all high-voltage capacitors before measuring resistance.

Resistance is a measure of the impedance related with current. The unit of resistance is Ohm (Ω).

The ranges for resistance of the meter are: 200.0 Ω , 2.000k Ω , 20.00k Ω , 200.0k Ω , 2.000M Ω , and 20.00M Ω .

To measure resistance:

1. Set the rotary switch at the proper position.
2. Connect the black measuring tip and the red measuring tip to the input socket of COM and the input socket of V Ω , respectively.
3. Measure the resistance of the circuit to be tested with the other ends of the measuring tips.
4. Read the measured value of resistance from LCD.

The following are some tips for measuring resistance:

The measured resistance of a resistor connected to a circuit usually differs to a certain degree from the rated resistance.

This is because the test current given by the meter flows through all possible pathways across the two test tips.

When measuring values of low resistance, in order to get an accurate value, please first short out the two meter tips and read the value of resistance when the meter tips are short out, which should be deducted from the measured resistance for the resistor to be tested.

When the switch of the meter is at the position of resistance, the output voltage can turn on a Si diode or transistor by reaching the value of positive turning-on voltage. In order to prevent this situation

DIGITAL MULTIMETER

from occurring, do not use the range of 40M Ω when conducting measurements on a resistor connected to a circuit.

When the range is set at 20M Ω it takes several seconds to get a stable reading, which is normal for measuring values of high resistance.

If there is no input (e.g. in the case of an open circuit), the display outputs “ 1 ”, which means that the measured value exceeds the range.

3.2.3 Diode Measurement

WARNING

In order to prevent the meter or the equipment to be measured from being damaged, always turn off all power supplies for the circuit to be measured and discharge all high voltage capacitors before conducting measurements for a diode.

Conducting measurements for a diode disconnected from a circuit:

1. Set the rotary switch at  position.
 2. Connect the black measuring tip and the red measuring tip to the COM input socket and the Ω input socket, respectively.
 3. Connect the black measuring tip and the red measuring tip to the cathode and the anode of the diode to be measured, respectively.
 4. The positive partial voltage of the diode to be measured will be displayed by the meter. If the measuring tips are connected to the wrong poles, “ 1 ” will be displayed by the meter.
- When the diode is connected to a circuit, the positive voltage of a good diode should be 0.5V to 0.8V; however, the readings of reversed partial voltage varies, because it depends on the resistance of other pathways between the two measuring tips.

3.2.4 Continuity Measurement

WARNING

In order to prevent the meter or the equipment to be measured from being damaged, always turn off all power supplies for the circuit to be measured and discharge all high-voltage capacitors before conducting the Humming ON/OFF test.

DIGITAL MULTIMETER

To conduct ON/OFF tests:

1. Set the rotary switch at **ON** position.
2. Connect the black measuring tip and the red measuring tip to the COM input socket and the Ω input socket, respectively.
3. Measuring the resistance of the circuit to be tested with the other ends of the measuring tips.
4. When conducting ON/OFF tests, if the resistance of the circuit to be test is not greater than about 600 Ω , the buzzer will hum.

3.2.5 Measuring capacitance

WARNING

In order to prevent the meter or the equipment to be measured from being damaged, always turn off all power supplies for the circuit to be measured and discharge all high-voltage capacitors before measuring capacitance. Make sure that the capacitors have been discharged with the switch at the position of DC voltage.

The ranges for capacitance of this meter are 20.00nF, 200.0nF, 2.000 μ F, and 200.0 μ F.

To measure capacitance

1. Set the rotary switch at a proper position, and press down the "Cx/Lx" key.
2. Connect the black measuring tip and the red measuring tip to the COM input socket and the CX input socket. (You can also use the dedicated multi-functional test sockets to measure capacitance).
3. Measure the capacitance of the capacitor to be tested with the other ends of the test tips, and read the measured value from LCD.

The following are some tips for measuring capacitance:

When conducting measurements on capacitors with high capacitance with this meter, it takes some time to obtain a stable value.

In order to improve the precision for the measured value low than 20nF, please deduct the distributive capacitance of the meter and wires.

DIGITAL MULTIMETER

3.2.6 Transistor measurement

WARNING

Do not apply a voltage higher than DC 250V or AC (effective voltage) across the common terminal and the hFE terminal in order to avoid electric shock and/or damaging the meter.

1. Set the rotary switch at the position of hFE.
2. Connect the multi-functional test socket to the meter with correct connections (the "+" terminal plug of the dedicated multi-functional test apparatus should be connected to the hFE terminal of the meter, and the "COM" plug to the common end).
3. Determine whether the transistor is of NPN type or PNP type, then pulg the three ends (e,b,c) of the transistor into the corresponded holes on the dedicated multi-functional test sockets.
4. Read the value from LCD, which approximately equals to the hFE value of the transistor to be tested .

3.2.7 Measuring inductance

WARNING

Do not conduct measurements for frequency related with voltages higher than DC 250V or AC (effective voltage) in order to avoid electric shock and/or damaging the meter .

The ranges for inductance of this meter are: 20.00mH, 200.0mH, 2.000H, AND 20.00H.

To measure inductance:

1. Set the rotary switch at a proper position, and press down "Cx /Lx" key.
2. Connect the black measuring tip and the red measuring tip to the COM input socket and the LX input socket, respectively.
3. Measure the capacitance of the capacitor to be tested with the other ends of the measuring tips, and read the measured values from LCD.

DIGITAL MULTIMETER

3.2.8 Transistor measurement

WARNING

Do not apply a voltage higher than DC 250V or AC(effective voltage) between the common terminal and the °C terminal to prevent electric shock and/or damaging the meter. Do not conduct measurements on surfaces with voltage higher than DC 60V or AC 24V(effective voltage) to prevent electric shock. Do not conduct temperature measurements in a microwave oven to prevent the meter from catching fire or being damaged.

Measuring temperatures:

1. Set the rotary switch at the position of °C, and LCD with output the value of the ambient temperature.
2. Properly connect the multi-functional test socket to the meter ("+"terminal plug of the dedicated multi-functional test socket is connected to the °C terminal, and "COM" plug is connected to the common terminal).
3. Properly plug the Type-K thermoelectric couple to the temperature sockets of the dedicated multi-function test sockets.
4. Conduct measurements on the surface or the inner part of the object using the measuring tips of the thermoelectric couple.
5. Read the measured value from LCD.

3.2.9 Measuring Current

WARNING

If the voltage between earth and the open circuit exceeds 250V , please do not try to conduct current measurements on the circuit. In case the fuse is broken during the measurement, the meter can be damaged or your body can be hurt. In order to avoid damaging the meter or the equipment to be tested, please check the fuse of the meter before conducting any current measurement. During the measurement, please select the correct input socket, the correct position of functions for the switch, and measuring range. When one end of a test tip is plugged into the current input socket, never connect the other end to any other circuit in parallel.

DIGITAL MULTIMETER

The ranges for DC current of this meter are 200.0mA and 10.00A; The ranges for AC current of this meter are 200.0mA and 10.00A. Measuring current:

1. Disconnect the circuit to be tested from the power supply, and discharge all high-voltage capacitors in the circuit to be tested.
2. Set the rotary switch at a proper position.
3. Connect the black test tip to the COM input socket. If the current to be measured is less than 200mA, connect the red test tip to the mA input socket; if the current to be tested is between 200mA and 10A, connect the red test tip to the 10A input socket.
4. Open the circuit to be tested, and connect the black test tip to one end(with lower potential)of the open circuit, and then connect the red test tip to the other end (with higher potential) of the open circuit. (A reversed connection of the test tips will result in readings of negative values, however, this will not damage the meter.)
5. Connect the circuit to the power supply, and read the displayed value. If the display only outputs "1" , which means that the input exceeds the selected range, the rotary switch should be set at a higher range.
6. Turn off the power supply for the circuit to be tested, and discharge all high-voltage capacitors, and then disconnect the test tip of the meter and restore the circuit to its original state.

4 Technical Parameters

4.1 General parameters

Surrounding conditions for operation:

600V CAT III and 1000V CAT II

Contamination level: 2

Elevation<2000m.

Temperature (humidity) at the operation site: 0~40°C

(RH<80%, not considered when <10°C).

Temperature (humidity) at the storage site: -10~60°C (RH<70% , battery off).

Temp. coefficient: 0.1xAccuracy/°C(<18°C or >28°C).

Max. voltage allowed between the measuring end and earth:

DC 1000V or AC 750V (effective voltage)

Fuse protection: position of mA: self-recovery fuse F500mA/250V

Sampling rate: about 3 times/second.

DIGITAL MULTIMETER

Display: 3 ½ bit LCD. Unit will be automatically displayed according to the selected measuring function.

out of range indication: LCD will output "1"

Low voltage indication for the battery: when the battery voltage is lower than the normal operation voltage, ""

Input polarity indication: "-" sign will be automatically displayed.

Power: DC 9V 

Battery type: NEDA 1604, 6F22, or 006P.

Dimensions: 195(L)x92(W)x55(H)mm.

Weight: about 380g(with batteries).

4.2 Precision parameters

Accuracy: \pm (%reading+graduation), with one year warranty.

Standard conditions: ambient temperature 18°C to 28°C , relative humidity not higher than 80%.

4.2.1 DC Voltage

Range	Resolution	Accuracy
200mV	0.1mV	\pm (0.5% of reading + 1 graduation)
2V	1mV	
20V	10mV	
200V	100mV	
1000V	1V	\pm (0.8% of reading + 2 graduation)

Input impedance : 10M

Max. input voltage: 1000Vdc or 750Vac (effective voltage), 250Vdc or ac (effective voltage) for a range of 200mV.

4.2.2 AC Voltage

Range	Resolution	Accuracy
2V	1mV	\pm (0.8% of reading + 3 graduation)
20V	10mV	
200V	100mV	
750V	1V	\pm (1.2% of reading + 3 graduation)

DIGITAL MULTIMETER

Input impedance : 10M Ω

Max. input voltage: DC 1000V or AC 750V(effective value), for the range of 200mV: DC 250V or AC(effective value).

Frequency response: 40Hz - 400Hz(40-200Hz for the range of 750V), sine wave effective value(mean value response)

4.2.3 Transistor

Range	Description	Test condition
hFE	The display outputs the approximate value of hFE, (0-1000)	The base current is about 10 μ A, and Vce is about 2.8V

Overload protection: self-recovery fuse (F500mA/250V)

4.2.4 Resistance

Range	Resolution	Accuracy
200 Ω	0.1 Ω	\pm (0.8% of reading + 3 graduation)
2k Ω	1 Ω	\pm (0.8% of reading + 1 graduation)
20k Ω	10 Ω	
200k Ω	100 Ω	
2M Ω	1k Ω	\pm (1.0% of reading + 2 graduation)
20M Ω	10k Ω	

Overload protection: DC 250V or AC 250V(effective value)

Open circuit voltage: low than 700mV

4.2.5 Diode

Function	Range	Resolution	Test condition
Diode test 	1V	0.001V	Positive DC current: about 1mA; Reversed DC voltage: about 3.0V. The display outputs the approximate value of positive voltage of the diode.

Overload protection: 250Vdc or 250Vac(effective voltage)

DIGITAL MULTIMETER

4.2.6 Humming ON/OFF

Func ^t	Description	Test condition
•)	If measured resistance is less than 70Ω, buzzer will sound	Open circuit voltage: 500mV

Overload protection: 250V DC or AC (rms)

4.2.7 Capacitance

Range	Resolution	Accuracy
20nF	1nF	±(4% of reading +8 graduation)
200nF	0.1nF	
2μF	1μF	
200μF	0.1μF	±(4% of reading +15 graduation)

Overload protection: self-recovery fuse(F500mA/250V)

4.2.8 Inductance

Range	Resolution	Accuracy
20mH	10uH	±(3% of reading +8 graduation)
200mH	0.1mH	
2H	1mH	
20H	10mH	

Overload protection: self-recovery fuse(F500mA/250V)

4.2.9 Temperature

Range	Resolution	Accuracy
-20°C~0°C	1°C	±(5.0% of reading +4 graduation)
1°C~400°C		±(1.0% of reading +3 graduation)
401°C~1000°C		±2.0% of reading

Error of thermoelectric couple is not included in temperature parameters.

Overload protection: self-recovery fuse (F500mA/250V)

DIGITAL MULTIMETER

4.2.10 DC Current

Range	Resolution	Accuracy
200mA	0.1mA	±(1.5% of reading +1 graduation)
10A	10mA	±(2.0% of reading +5 graduation)

Overload protection: self-recovery fuse (F500mA/250V); No fuse protection for the range of 10A.

Max. input current: mA: DC 200mA or AC (effective value);

10A: DC 10A or AC (effective value)

When measuring current which is greater than 5A, do not conduct measurements consecutively for more than 4 minutes. After the measurements are completed, do not conduct new current measurements until 10 minutes later.

4.2.11 AC Current

Range	Resolution	Accuracy
200mA	0.1mA	±(1.8% of reading +3 graduation)
10A	10mA	±(3.0% of reading +7 graduation)

Overload protection: self-recovery fuse (F500mA/250V); No fuse protection for the range of 10A.

Max. input current: mA: DC 200mA or AC (effective value);

10A: DC 10A or AC (effective value)

When measuring current which is greater than 5A, do not conduct measurements consecutively for more than 4 minutes. After the measurements are completed, do not conduct new current measurements until 10 minutes later.

Frequency response: 40Hz-400Hz, sine wave effective value (mean value response)

5. Meter Maintenance

Basic maintenance information is given in this section, including instructions for replacing a fuse and replacing a batter.

Do not try to repair the meter unless you are an experienced service staff and you can get access to information regarding related calibration, performance tests, and services.

DIGITAL MULTIMETER

5.1 Routine maintenance

WARNING

In order to avoid electric shock or damaging the meter, please do not wet the interior of the meter, Always disconnect the test tips from the input signal before remove the shell or the battery cover.

Use a damp mop and a small amount of detergent to clean the shell of the meter periodically. Please do not use abrasive or chemical solvents.

If the input sockets are fouled or wet, the measurement might be affected.

Therefore, the input sockets need to be cleaned:

Turn off the meter, and pull out all test tips from the input sockets
Clean all dirt off the sockets.

Wet a new cotton stick with cleaner or lubricant(e.g.WD-40).

Clean every socket with the cotton stick, and the lubricant can prevent the sockets from contamination caused by high humidity.

5.2 Replacing the Probe

If insulation on probe is damaged, replace it.

WARNING

Use meet EN 61010-031 standard, rated CAT II 600V, 10A or better probe.

5.2 Replacing the Battery

WARNING

In order to avoid electric shock or physical hurting due to wrong readings, please replace the battery immediately when "" symbol appears on the display of the meter. In order to avoid electric shock or physical hurting, please turn off the meter and make sure that the test tips are disconnected from the circuit to be tested before taking off the battery cover for replacing the battery.

DIGITAL MULTIMETER

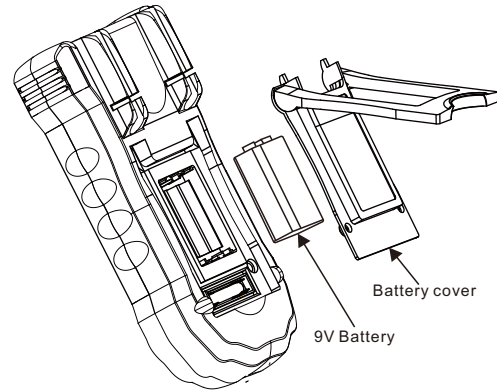

Fig. 2 Replacing the Battery

Please follow the steps below to replace the battery (also see Fig.2):

1. Turn off the power of the meter.
2. Pull out both test tips from the input sockets.
3. Use a screw driver to loosen the two screws fixing the battery cover.
4. Take off the battery cover.
5. Take off the used battery.
6. Put a new 9V (6F22) battery in place.
7. Put the battery cover in place ,and tighten the screws.

6. Accessories

Instruction manual	1 piece
Test tips	1 pair
Type K thermoelectric couple TP 01	1 pair
Dedicated multi-functional test sockets	1 piece

