

# Toy Motor Kit #615-4685 (10-135)

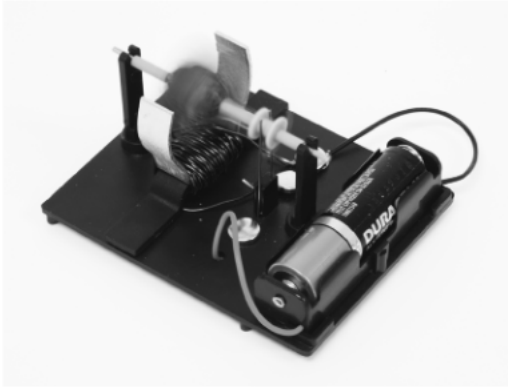

## Congratulations on your purchase of a Toy Motor Kit!

Despite the name, the motor isn't a toy at all, but more of a model. It packs a surprising amount of complexity and learning into a very compact package.

Most model motors use a permanent magnet to generate the required magnetic field. Ours does not, using instead a wire coil that acts as an electromagnet. Our motor also uses a commutator to make sure the current reverses at the proper time. These features make the Toy Motor very similar to electric motors sold commercially.

It is strongly recommended that you study this guide thoroughly before assembling the motor. Please feel free to contact us at any time if you have any questions.

### Parts List:

51-1355	Shaft Supports (#1)	2
60-0135	Wire, 100cm long coil (#2)	2
26-1040	Battery Holder (#3)	1
29-1038	Paper Fasteners (#4)	3
51-1350	Armature Half (#5)	2
26-9214	Tubing, about 1" (#6)	1
31-0135	Motor Shaft (#7)	1
51-1358	Mounting Bracket (#8)	1
33-0135	Bronze Wire Brushes (#9)	2
57-1005	Commutator Insulators (#10)	2
57-0135	Plastic Base (#11)	1
51-1352	Field Pole (#12)	1
24-10135	Instructions	1

### Tools Needed:

- Sandpaper
- Sharp knife, scissors, razor blade or wire strippers (for cutting and scraping)
- Small screwdriver (slotted)
- Pair of needle nose pliers
- Ruler (below)
- One (1) **new** AA battery, high quality alkaline. (Lower quality batteries many not generate enough current)

Part #9: Two (2) Wire Brushes - (33-0135)



Part #1: Two (2) Shaft Supports - (51-1355)



Part #5: Two (2) Armature Halves - (51-1350)

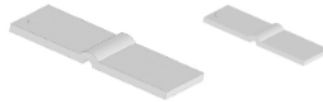

Part #10: Two (2) Commutators - (57-1005) Slide halves together as shown.



Part #2: Two (2) copper wire coils - 100cm long (60-0135)



Part #6: Insulating Tubing (26-9214)

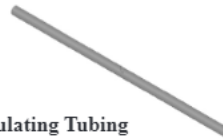

Part #3: One (1) Battery Holder with Leads - (26-1040)



Part #7: Motor Shaft (31-0135)



Part #11: Plastic Base - (57-0135)

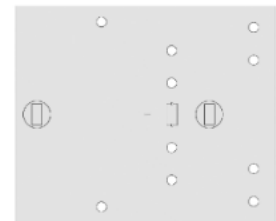

Part #4: Three (3) Fasteners (29-1038)



Part #8: Mounting Bracket (51-1358)

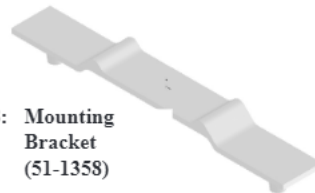

Part #12: Field Pole - (51-1352)



Cut tubing in 1/4" and 7/16" pieces

1/4" 7/16" - cut 2

Scrape wire 1"

1"

(Armature ends, field coil end are 2")

2"

Inch Scale

## Motor Assembly:

**Important!** The wire supplied has an insulated coating on it. Using sandpaper, clean the coating of insulation as directed below. Clean completely!

### STEP 1: Field Coil

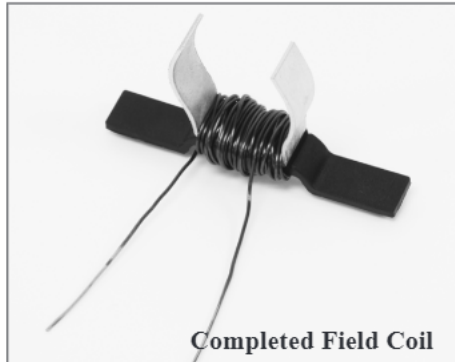

1. Unroll one of the wire coils. (Part #2)
2. Take the the parts for the field pole: Mouting bracket (Part #8) and Field Pole (Part #12)
3. Hold field pole (Part #12) and mouting bracket (Part #8) together. Leave 2" free of wire and begin winding the coil from Part #2 tightly around the two parts. Keep the wire low and tightly next to the last wind. Using all of the wire, keep wrapping and leave 2" free at the end as shown in *Diagram 1*. Make the winds as tight and as low of profile as possible.

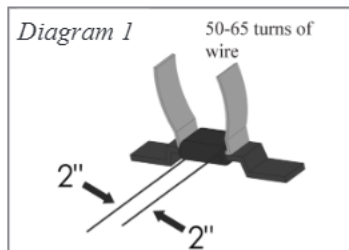

4. Scrape 1" insulation off each wire end and set field coil aside. **Insulation must be completely removed from the wire ends.**

### STEP 2: Armature

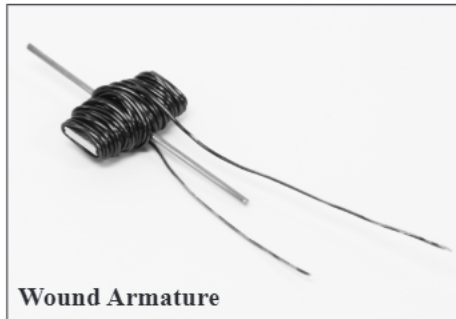

1. Unroll the other wire coil. (Part #2) Using sand paper, scrape off 2" of the coating from each end.
2. Put the motor shaft (Part #7) in between the two halves of the armature so that there is 1" of the motor shaft on one side and about 1 1/4" motor shaft on the other side (Part #5). See *Diagram 2*
3. Leaving 2" of wire free, wrap the wire coil around one side 8 times, cross over the middle to the other side and wrap the coil 8 times around that side. Cross over to the first side and wrap wire coil 8 times again, cross over the middle to the other side and wrap coil 8 times around that side again. Repeat until there are 2" left of wire. See again *Diagram 2*.

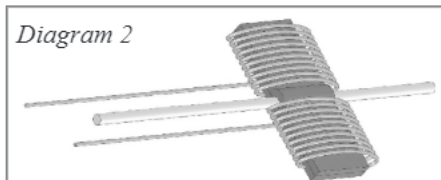

**Have the windings always go in the same direction and always have about the same amount of windings on each side.**

**For best results,  
wind the wire closely together and  
as tightly as possible!**

### STEP 3: Commutator



1. Cut a 7/16" piece of tubing (Part #6). Slide the cut piece onto the longer end of the motor shaft with protruding wires. Tubing **must** be pushed directly against the armature halves.

2. Put the halves of the commutator (Part #10) together as shown in *Diagram 3*. \*

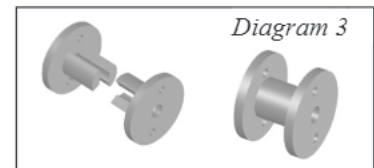

3. On the same side as the tubing, slide the commutator onto the motor shaft through the larger center hole.\* It may be tight.

4. Thread the wire from one side of the armature through the small hole of the commutator. Repeat with the wire from the other side of the armature. Both commutator halves must be at right angles to the armature. Make sure the wire is flush against the commutator. Trim wires as needed. See *Diagram 4*.

\*It may be helpful to slide half of the commutator on first thread the wire and then put on the second half of the commutator and thread the wire.

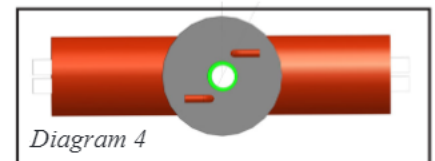

5. Cut a 1/4" piece of tubing. Slide it onto the motor shaft so that the commutator is held between pieces of tubing. Trim the wire extending after the commutator. See *Diagram 5 to the left*.

6. Cut a second piece of tubing 7/16" long and slide onto the opposite end.

7. Make sure there is about 1/4" of free space on the ends of the shaft.

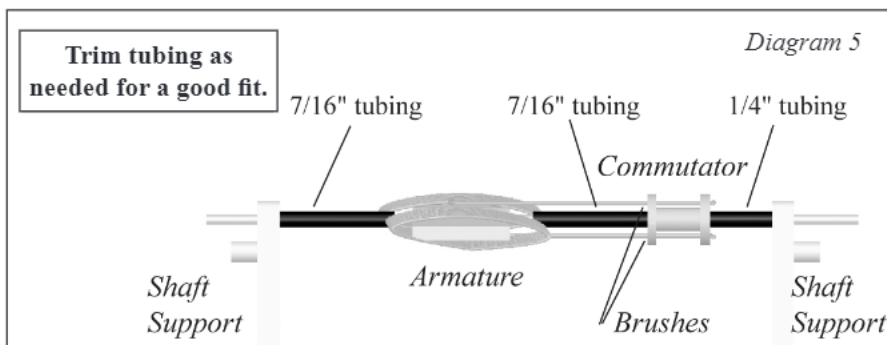

**Trim tubing as needed for a good fit.**

7/16" tubing      7/16" tubing      1/4" tubing

Shaft Support      Armature      Commutator      Shaft Support

Brushes

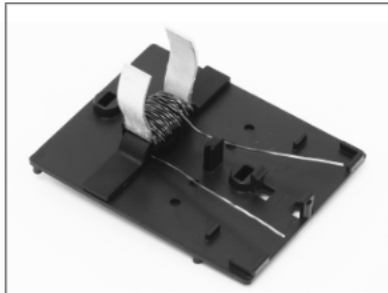

Field Coil Mounted on Base

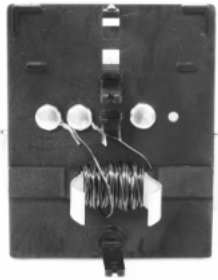

Field Coil and Brushes Wired

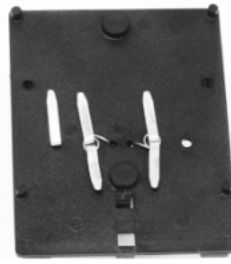

Field Coil and Brushes Wired, Underside View

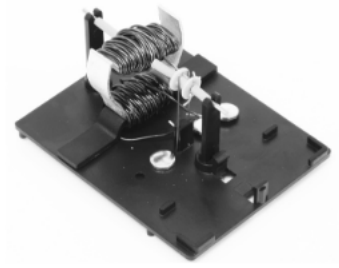

Armature and Field Coil Mounted on Base

### STEP 4: Assembling Motor:

1. Fasten the field coil assembly to the plastic base (Part #11) by pressing mounting bracket onto **Holes 1**, shown in *Diagram 6*. Wire ends should be pointing toward the middle of the base

2. Place one shaft support (Part #1) into the rectangular hold closest to the field coil (**Hole 2**, *Diagram 6*). The support should be perpendicular to the base.

3. Place the second shaft support (Part #1) into the rectangular hole farthest from the field coil (**Hole 7**, *Diagram 6*). The shaft support should be perpendicular to the base.

4. Loop the end of one of the 2" wires from the field pole (**Step 1: Field Coil**) around one of the paper fasteners and twist. Slide the fastener through **Hole 3**, *Diagram 6*. (Open fastener lightly, just to keep it in place, will be using it again.)

5. Loop the end of the other 2" long wire from the field coil through another paper fastener and twist. Slide fastener through **Hole 10**, *Diagram 6*. (Open fastener lightly, just to keep it in place, will be using it again.)

6. Bend looped end of brush (Part #9) 90 degrees. (See *Diagram 5*).

7. Flip the base over. Slide one brush through **Hole 5**. Then slide the loop at the end of the brush over the fastener in **Hole 3**. Slide the second brush through **Hole 6**. Put a fastener in **Hole 4** and slide the brush over it. (Open fasteners on the bottom lightly, but only to keep it in place, will be using it again.)

8. Lay the armature on the two shaft supports and snap into place. Brushes are on the outside of the commutator. The commutator should be touching the brushes. If you wish, use a light oil for lubrication. See *Diagram 5* on previous page.

9. For visual help with the wiring placements please refer to *Diagram 7*.

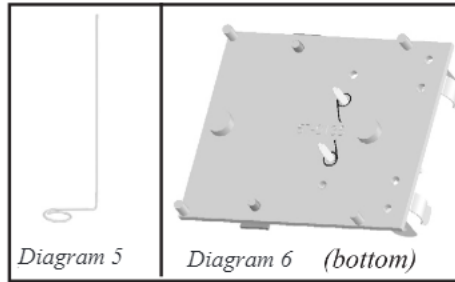
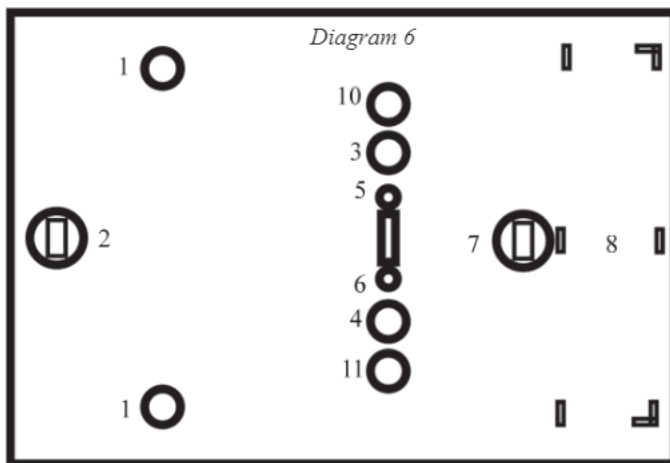

Diagram 5

Diagram 6 (bottom)



Hole Diagram

1. For field coil bracket
- 2, 7. For shaft support
3. For brush to field coil
4. For battery lead to brush
- 5,6. For brush
8. Bracket for battery holder
10. For battery lead to field coil

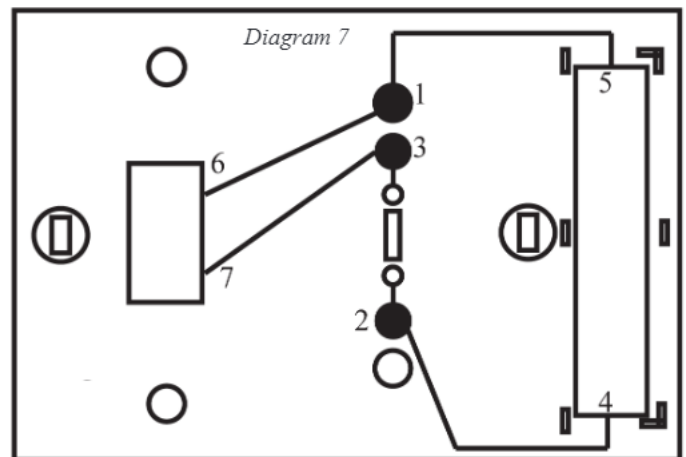

Wire Diagram

1. Fastener with negative battery lead and wire from field coil
2. Fastener with brush and positive battery lead
3. Fastener with brush and wire from field coil
4. Positive battery lead
5. Negative battery lead
- 6, 7. Wire from field coil

Note: Every connection must consist of two wires (i.e. 1 brush and 1 wire from the field coil).

## STEP 5: Connect Motor To Battery:

1. Place the battery holder in the mounting tabs on the base.
2. Trim the insulation off the end of the red lead and loop it around the fastener in **Hole 4**. It should contact the brush that is going through **Hole 6**. For neatness, you can run the lead through the empty **Hole 11**.
3. Trim the insulation off the end of the black lead and loop the black lead around the fastener in **Hole 10**. It should be contacting the wire from the field coil.
4. Spread all the fasteners open completely and secure the fasteners in place. Make sure they do not contact each other, as this could cause a short!
5. Install the battery. Watch it spin!

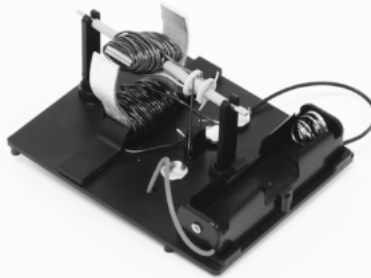

Armature, Field Coil, and Battery Holder Mounted on Base

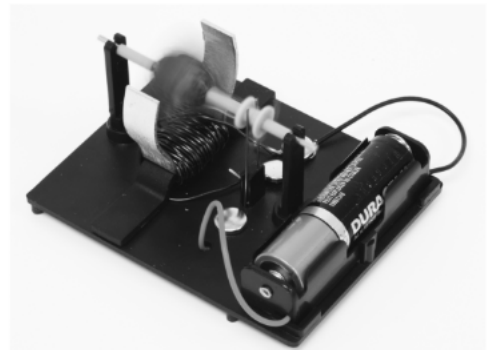

Completed Motor with Battery, in Operation

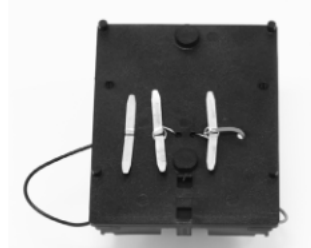

Armature, Field Coil, and Battery Holder Mounted on Base Underside View

Please refer to the following pages for photographs of all the major steps required to complete your toy motor kit.

### Helpful Tips for Building the Motor:

- The insulation **must** be completely removed from the wire ends or the motor will not work
- You may need to gently bend the U shaped portion of the field coil for armature to spin freely.
- Make sure each fastener has two connections, no more or less.
- You may need to remove insulation from the battery leads in order to get a good connection with the fasteners.
- Use a fresh alkaline battery for best results
- Wind the armature and field coil as **tightly** and evenly as possible.

### Parts List:

<b>51-1355</b> Shaft Supports (#1)	2
<b>60-0135</b> Wire, 100cm long coil (#2)	2
<b>26-1040</b> Battery Holder (#3)	1
<b>29-1038</b> Paper Fasteners (#4)	3
<b>51-1350</b> Armature Half (#5)	2
<b>26-9214</b> Tubing, about 1" (#6)	1
<b>31-0135</b> Motor Shaft 9 (#7)	1
<b>51-1358</b> Mounting Bracket (#8)	1
<b>33-0135</b> Bronze Wire Brushes (#9)	2
<b>57-1005</b> Commutator Insulators (#10)	2
<b>57-0135</b> Plastic Base (#11)	1
<b>51-1352</b> Field Pole (#12)	1
<b>24-10135</b> Instructions	1

### What to do if your motor doesn't work:

1. Watch for tiny sparks between the brushes and commutator. Sparks indicate a complete circuit.
2. When spinning by hand to initially start the motor, you may feel resistance from the armature. If so, reverse the direction you are trying to spin the armature (or reverse the battery to spin the motor in that direction).
3. Check all electrical connections. Are they scraped free of insulation? (Places to check: both wires from armature threaded through the commutators - one to the battery, on to the brushes)
4. Use the multimeter to check for continuity. When the armature wires that run through the commutator are in contact with the brushes, the circuit will be complete.
5. Can the shaft spin freely by hand? If not, you may have to trim your tubing. (If the field pole interferes with armature rotation, gently bend it out of the way.)
6. Make sure holes in both commutators are at an angle to the armature.
7. Is your battery fresh? Try using more voltage up to and including a 9v battery.
8. Do both brushes contact the commutator lightly? Adjust by trial and error. If the brushes are too close together, they will not allow the commutator to spin freely.
9. Use an occasional drop of oil at both ends of the motor shaft where it meets the shaft supports.
10. The "bright" surfaces of the bronze wires may oxidize eventually. This may lead to poor contact between brushes and commutators. To prevent this, coat the "bright" surfaces with solder by "Tinning" the surfaces using an electric solder iron.
11. To keep the armature and commutators at right angles to each other, you can apply some "super glue" to make a permanent bond at the contact points.
12. You may have to bend the field poles to get them close to the armature assembly. They should be as close as possible without touching.
13. Make sure the windings on the armature are even on either side, and go in the same direction.

### Warranty and Parts:

We replace all defective or missing parts free of charge. Our products are warranted to be free from defect for 90 days.

---

## Experiments:

1. Put the battery in the other way. What does the motor do? Will it spin the same or opposite way? Answer this before you do the experiment.
2. What happens to the direction of shaft rotation if you turn the commutator 180°? Answer before the experiment.
3. Put the commutator in the same plane as the armature and try to run the motor. How important is the plane of the commutator relative to the plane of the armature?
4. Handle the shaft with your fingers as it rotates at low speeds. Note how the twisting force (torque) is not constant as the shaft rotates through one revolution. Plot out the graph of torque vs. angular position. Define 0° starting point for the armature, then feel the torque as the shaft rotates through 360°. Explain your graph.
5. Short out the commutator with fine wire. Attach two wires from each brush to an armature wire. What is the resting, stable position of the armature when power is connected? (Use short, quick connections.)
6. The field pole extends up and around the armature but has no wire around it. Do you need this? Could you wind wire around the middle of the mounting bracket instead? Unwind the field coil and remove it. Now wind the coil of wire back again and connect up the motor. Does removal of the field pole reduce the efficiency of the motor? Explain.
7. Connect 6 or 9 volt batteries to the motor. What happens?
  - How would you redesign the motor to run on 15 volts? Note the blackening around the brushes and commutator. Why does this happen?
  - Leave the motor going with 9 volts attached and run it to destruction. What part fails first? What part do you think would have failed next? Fix it if you can and run it again until it fails. This is called destructive testing. What does it teach you?
8. Try connecting an AC voltage source such as a 6-12 volt AC power supply in place of the battery. (*Do not use the 110 volt line outlet directly as this is dangerous and will instantly destroy your motor!*) Does the motor run? Why?

**Hint:** This kind of motor is known as a universal motor. Explain.

## Theory:

Every magnet has 2 poles - **north**, or *positive*, and **south** or *negative*. "Like" poles repel each other; "unlike" poles attract. One north pole repels another north and attracts a south.

The attracting and repelling of the magnets causes the motor to run. The field poles become an electromagnet when an electric current flows through the wire coil around them. The armature becomes an electromagnet when an electric current passes through its wire coil. The armature, however, produces a reversing magnetic field while the magnetic field produced by the field poles remains stationary.

The North pole of the field pole attracts the South pole of the armature, which turns in response to this magnetic attraction. But in order to keep the armature turning, you must break the current and change the polarity of the armature magnet. Otherwise the armature would remain permanently fixed in one position for as long as electric current was flowing and nothing would move.

Breaking the electric current through the armature and reversing its direction is done by a switch consisting of brushes and commutators. The commutators attach directly to the motor due to their location on the shaft and are connected to the armature by the wires threaded through them. The brushes rest lightly against the wires connecting the commutators to the armature. The brushes complete the electric circuit and enable the electric current to flow into the armature wires.

If the electricity always flowed in the same direction, the field magnet would pull the armature in the same position. It would freeze in this position and there would be no motion. However, just at the height of the attraction of field magnet for armature magnet, when the armature magnet has turned halfway around, the brush strikes the armature wires on the motor shaft to reverse the current's direction. Instead of flowing from the left wing of the armature through to the right, it now flows in the other direction, reversing North and South poles.

The arrangement of wires from armature through commutators is what causes this reversal. Remember that you twisted the wires 90° to position them at right angles to the armature. Due to this orientation, the armature magnet reverses itself as the armature turns halfway, and the armature completes its revolution as what is now a North pole is repelled by the North pole of the field magnet. The South pole of the armature will be continually turning in a series of half turns to seek the stationary North field pole.

The reason the armature revolves in a complete circle of 360° rather than flipping back and forth in half circles is because the momentum of the motor will carry the attraction of North and South a little past the point of peak attraction; as polarity changes, the armature completes its revolution in an attempt to "catch up" with the change in location of the poles.