

# Illuminated Pushbuttons

Part Nos. 17PBA291 and 17PBA313

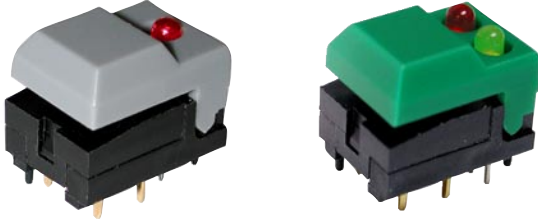

## SPECIFICATIONS

CIRCUIT	: SPDT
CURRENT RATING	: 50mA
VOLTAGE RATING	: 12 VDC
CONTACT RESISTANCE	: 100 mΩ Max (initial)
INSULATION RESISTANCE	: 100 MΩ min.
OPERATING FORCE	: 200gf ± 50gf
TOTAL TRAVEL	: 1mm ± 0.5mm
OPERATING LIFE	: 500,000 cycles min.
SOLDER SPECIFICATION	: 265°C for 5 seconds
OPERATING TEMPERATURE	: +10°C ~ +60°C

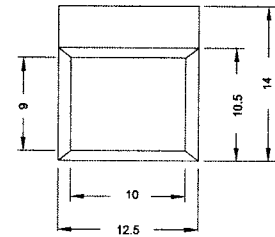
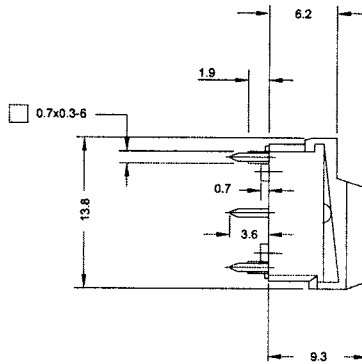
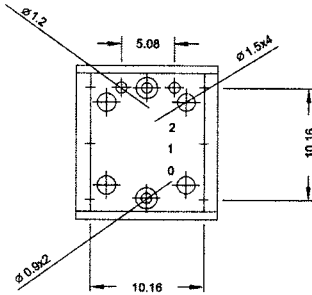

(A1 CAP)

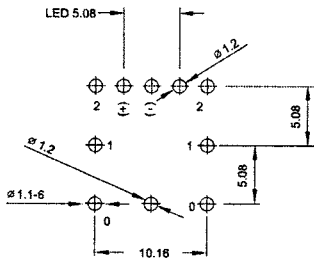

P.C.B. Mounting Holes

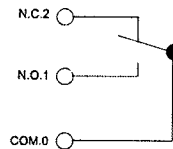

SPDT  
CONTACT CONFIGURATION

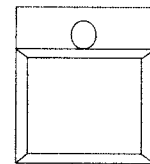

(A2 CAP)

S P 8 8

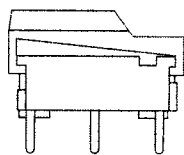

CAP STYLES	
A1	
A2	

CAP COLORS	
3	GREEN
9	GREY

LED COLORS	
1	RED
3	GREEN