

**FLASHING LED– BLINKING LED****Part Nos. 08L5013SRC-B, 08L5013UBC-B, 08L5013UGC-B, 08L5013UYC-B****ULTRA LED LAMPS**

FYL-5013XX-XX

**■ Features:**

- 5.0mm Round Type LED Lamps.
- Ultra brightness.
- Choice of various viewing angles.
- Water clear lens.
- Popular T-1 diameter package.
- IC compatible /Low current capability.

**■ Part No.:**

FYL-5013SRX
FYL-5013UYX
FYL-5013UGX
FYL-5013UBX

Note:X = Len Color: C=Water Clear,

**■ Description:**

- Color Code & Chip characteristics: (Test Condition: IF=20mA)

Emitting Color		Dice Material	Peak Wave Length( $\lambda_P$ ) (nm)	Spectral Line halfwidth( $\Delta\lambda_{1/2}$ )	Forward Voltage(VF) Unit:V		Luminous Intensity (lv) Unit:ucd
					Typ	Max	
SR	Hi Red	AlGaAs,SH	660nm	20nm	1.85	2.20	3500
UY	Ultra Yellow	AlGaInP	590nm	20nm	2.10	2.50	7000
UG	Ultra Green	AlGaInP	574nm	30nm	2.20	2.50	5000
UB	Ultra Blue	InGaN	470nm	30nm	3.50	4.20	7000

■ Electrical-optical characteristics: (Ta=25°C)

Parameter	Symbol	AlGaAs	GaAsP	AlGalnP	InGaN	Unit
Power Dissipation	$P_{ad}$	60	80	75	120	mW
Peak Forward Current *	$I_{pf}$	150	150	150	100	mA
Continuous Forward Current	$I_{af}$	25	30	30	30	mA

Notes:

- \* Test Condition = Duty 0.1, 10KHZ

■ Package configuration & Internal circuit diagram:

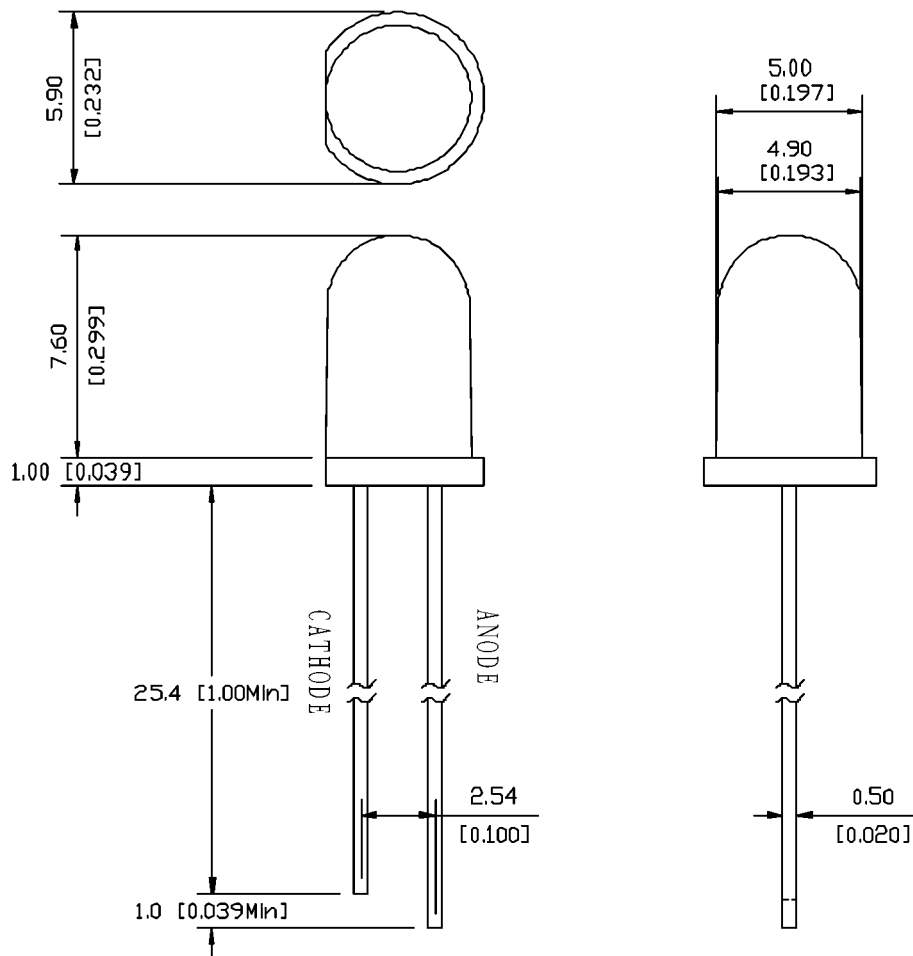

Notes:

- All dimensions are in millimeters (inches)
- Tolerance is  $\pm 0.25(0.01")$  unless otherwise noted.
- Specifications are subject to change without notice.

# ULTRA LED LAMPS

FYL-5013XX-XX

## Absolute maximum ratings (Ta=25°C)

Reverse Voltage	5V
Reverse Current	20μA
Operating Temperature Range	-40°C to +85°C
Storage Temperature Range	-40°C to +85°C
Lead Solder Temperature (1.6mm(1/16") from body) 230°C for 5 Seconds	

## Typical electrical-optical characteristics curves:

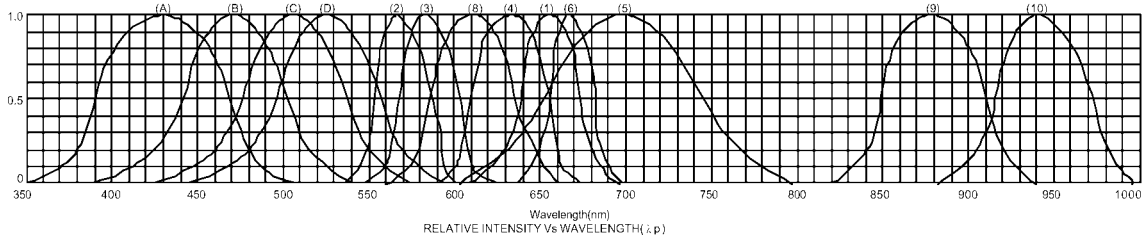

- (1) - GaAsP/GaAs 655nm/Red
- (2) - GaP 570nm/Yellow Green
- (3) - GaAsP/GaP 585nm/Yellow
- (4) - GaAsP/GaP 635nm/Orange & Hi-Eff Red
- (5) - GaP 700nm/Bright Red
- (6) - GaAlAs/GaAs 660nm/Super Red
- (8) - GaAsP/GaP 610nm/Super Red
- (9) - GaAlAs 880nm
- (10) - GaAs/GaAs & GaAlAs/GaAs 940nm
- (A) - GaN/SiC 430nm/Blue
- (B) - InGaN/SiC 470nm/Blue
- (C) - InGaN/SiC 505nm/Ultra Green
- (D) - InGaAl/SiC 525nm/Ultra Green

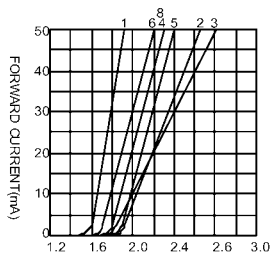

FORWARD VOLTAGE (V)  
FORWARD CURRENT vs.  
FORWARD VOLTAGE

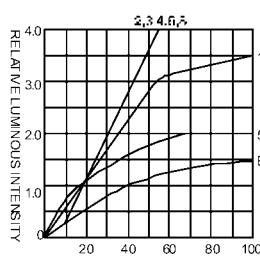

FORWARD CURRENT (mA)  
RELATIVE LUMINOUS  
INTENSITY vs. FORWARD  
CURRENT

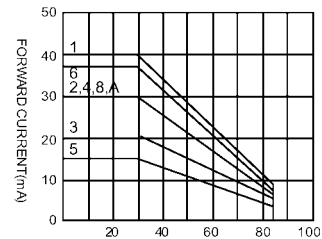

AMBIENT TEMPERATURE Ta (°C)  
FORWARD CURRENT vs. AMBIENT  
TEMPERATURE

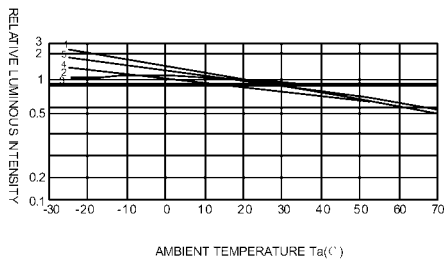

AMBIENT TEMPERATURE Ta (°C)

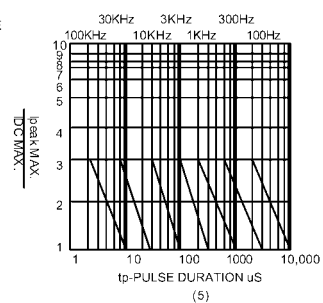
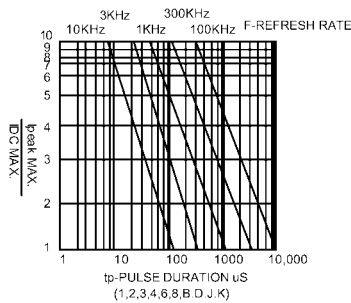

NOTE: 25°C free air temperature unless otherwise specified