

MASTECH®

MS8268

HANDHELD DIGITAL MULTIMETER OPERATOR'S INSTRUCTION MANUAL

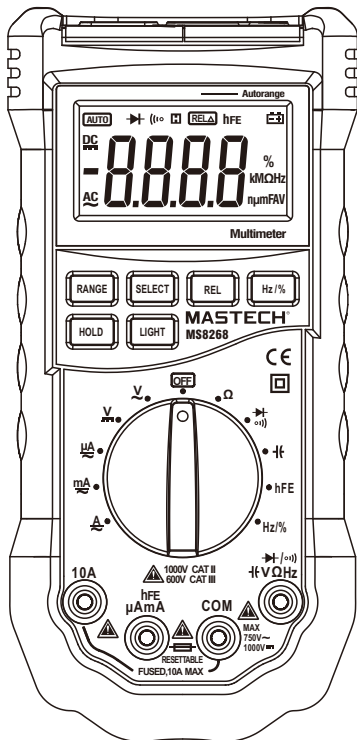

CAT II
1000V

CAT III
600V

CONTENTS

1. GENERAL INSTRUCTIONS.....	1
1.1 Precaution safety measures.....	1
1.1.1 Preliminary.....	1
1.1.2 During use.....	2
1.1.3 Symbols.....	4
1.1.4 Instructions.....	4
1.2 Safety mechanisms.....	5
2. DESCRIPTION.....	6
2.1 Instrument Familiarization.....	6
2.2 LCD Display.....	7
2.3 Keypad.....	9
2.4 Terminals.....	10
2.5 Rotary switch.....	11
2.6 Accessories.....	11
3. FUNCTION DESCRIPTION.....	12
3.1 General Functions.....	12
3.1.1 Misconnection alarm system.....	12
3.1.2 DATA HOLD mode.....	13
3.1.3 Manual ranging and Autorange mode.....	13
3.1.4 Battery Saver.....	14
3.1.5 Relative measurement mode.....	14
3.2 Measurement Functions.....	15
3.2.1 AC and DC Voltage measurement.....	15

CONTENTS

3.2.2 Resistance measurement.....	16
3.2.3 Diode Test.....	17
3.2.4 Continuity Check.....	18
3.2.5 Transistor measurement.....	18
3.2.6 Capacitance measurement.....	19
3.2.7 Frequency and Duty Cycle measurement.....	20
3.2.8 Current measurement.....	22
4. TECHNICAL SPECIFICATIONS.....	23
4.1 General specifications.....	23
4.2 Measurement specifications.....	24
4.2.1 DC Voltage.....	24
4.2.2 AC Voltage.....	25
4.2.3 Resistance.....	25
4.2.4 Audible continuity.....	25
4.2.5 Diode.....	26
4.2.6 Transistor.....	26
4.2.7 Capacitance.....	26
4.2.8 Frequency.....	26
4.2.9 DC current.....	28
4.2.10 AC current.....	28
4.2.11 Duty Cycle	29
5. MAINTENANCE.....	29
5.1 General Maintenance.....	29
5.2 Fuse replacement.....	29
5.3 Battery replacement.....	30

1. GENERAL INSTRUCTIONS

This instrument complies with IEC 1010-1 (61010-1 @IEC: 2001), CAT II 1000V and CAT III 600V overvoltage standards. See Specifications.

To get the best service from this instrument, read carefully this user's manual and respect the detailed safety precautions.

International symbols used on the Meter and in this manual are explained in chapter 1.1.3

1.1 Precautions safety measures

1.1.1 Preliminary

* Measurement category III is for measurements performed in the building installation.

NOTE: Examples are measurements on distribution boards, circuit-breakers, wiring, including cables, bus-bars, junction boxes, switches, socket-outlets in the fixed installation, and equipment for industrial use and some other equipment, for example, stationary motors with permanent connection to the fixed installation.

* Measurement category II is for measurements performed on circuits directly connected to the low voltage installation.

NOTE: Examples are measurements on household appliances, portable tools and similar equipment.

* Measurement category I is for measurements performed on circuits not directly connected to MAINS.

NOTE: Examples are measurements on circuits not derived from MAINS, and specially protected (internal) MAINS derived circuits. In the latter case, transient stresses are variable; for that reason, requires that the transient withstand capability of the equipment is made known to the user.

* When using this Multimeter, the user must observe all normal safety rules concerning:

- Protection against the dangers of electric current.
- Protection of the Multimeter against misuse.

* For your own safety, only use the test probes supplied with the instrument. Before use, Check that they are in good condition.

1.1.2 During use

* If the meter is used near noise generating equipment, be aware that display may become unstable or indicate large errors.

* Do not use the meter or test leads if they look damaged.

* Use the meter only as specified in this manual; otherwise, the protection provided by the meter may be impaired.

* Use extreme caution when working around bare conductors or bus bars.

* Do not operate the meter around explosive gas, vapor, or dust.

* Verify a Meter's operation by measuring a known voltage. Do not use the Meter if it operates abnormally. Protection may be impaired. When in doubt, have the Meter serviced.

* Uses the proper terminals, function, and range for your measurements.

* When the range of the value to be measured is unknown, check that the range initially set on the multimeter is the highest possible or, wherever possible, choose the autoranging mode.

* To avoid damages to the instrument, do not exceed the maximum limits of the input values shown in the technical specification tables.









* When the multimeter is linked to measurement circuits, do not touch unused terminals.

- * Do not apply any voltage measurement between the 10A terminal and the COM terminal.
- * Caution when working with voltages above 60Vdc or 30Vac rms. Such voltages pose a shock hazard.
- * When using the probes, keep your fingers behind the finger guards.
- * When making connections, connect the common test lead before connecting the live test lead; when disconnecting, disconnect the live test lead before disconnecting the common test lead.
- * Before changing functions, disconnect the test leads from the circuit under test.
- * For all dc functions, including manual or auto-ranging, to avoid the risk of shock due to possible improper reading, verify the presence of any ac voltages by first using the ac function. Then select a dc voltage range equal to or greater than the ac range.
- * Disconnect circuits power and discharge all high-voltage capacitors before testing resistance, continuity, diodes, or capacitance.
- * Before measuring current, check the meter's fuse and turn off power to the circuit before connecting the meter to the circuit.
- * Never perform resistance or continuity measurements on live circuits.
- * In TV repair work, or when carrying out measurements on power switching circuits, remember that high amplitude voltage pulses at the test points can damage the multimeter. Use of a TV filter will attenuate any such pulses.
- * Use three 1.5V AAA batteries, properly installed in the Meter's battery case, to power the Meter.

- * Replace the batteries as soon as the battery indicator () appears. With a low battery, the Meter might produce false readings that can lead to electric shock and personal injury.
- * Do not measure voltages above 600V in Category III, or 1000V in Category II installations.

1.1.3 Symbols:

Symbols used in this manual and on the instrument:

	Caution: refer to the instruction manual. Incorrect use may result in damage to the device or its components.
	Dangerous voltage may be present.
	AC (Alternating Current)
	DC (Direct Current)
	AC or DC
	Earth ground
	Double insulated
	Fuse
	Conforms to European Union directives

1.1.4 Instructions

- * Remove test leads from the Meter before opening the Meter case or battery cover.
- * When servicing the Meter, use only specified replacement parts.
- * Before opening up the instrument, always disconnect from all sources of electric current and make sure you are not charged with static electricity, which may destroy internal components.

- * Any adjustment, maintenance or repair work carried out on the meter while it is live should be carried out only by appropriately qualified personnel, after having taken into account the instructions in this present manual.
- * A "qualified person" is someone who is familiar with the installation, construction and operation of the equipment and the hazards involved. He is trained and authorized to energize and de-energize circuits and equipment in accordance with established practices.
- * When the instrument is opened up, remember that some internal capacitors can retain a dangerous potential even after the instrument is switched off.
- * If any faults or abnormalities are observed, take the instrument out of service and ensure that it cannot be used until it has been checked out.
- * If the meter is not going to be used for a long time, take out the battery and do not store the meter in high temperature or high humidity environment.

1.2 Safety mechanisms

- * Misconnection alarm system
- * If the maximum range is repeatedly exceeded, a continuous audible signal warns the user in DCV, ACV, DCμA, ACμA, DC mA, AC mA, DC 10A and AC 10A functions.

2. DESCRIPTION

2.1 Instrument Familiarization

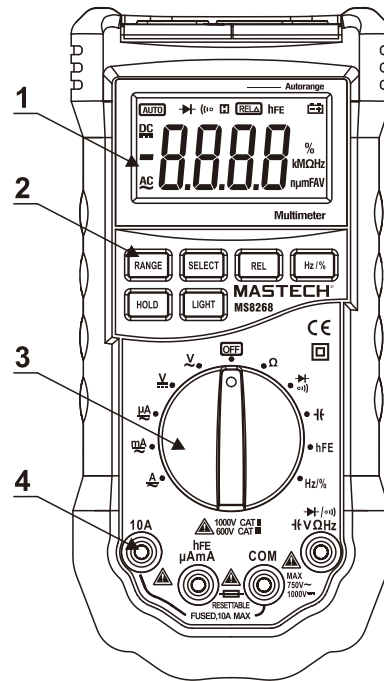

1. LCD display 2. Keypad 3. Rotary switch 4. Terminals

2.2 LCD Display

See Table 1 indicated for information about the LCD display.

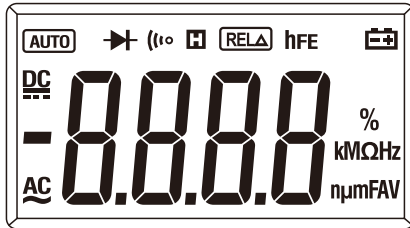

Table 1. Display Symbols

Symbol	Meaning
	The battery is low. ⚠ Warning: To avoid false readings, which could lead to possible electric shock or personal injury, replace the battery as soon as the battery indicator appears.
	Indicates negative readings.
	Indicator for ac voltage or current. AC voltage and current are displayed as the average of the absolute value of the input, calibrated to indicate the equivalent rms value of a sine wave.
	Indicator for dc voltage or current.
AUTO	The Meter is in the Autorange mode in which the meter automatically selects the range with the best resolution.

Table 1. Display Symbols (continued)

Symbol	Meaning	
RELA	Indicator for the Relative measurement.	
	Indicator for the Diode Test mode.	
hFE	Indicator for the transistor test mode.	
	Indicator for the Continuity Check mode.	
	Indicator for the Data Hold mode.	
V, mV	V:	Volts. The unit of voltage.
	mV:	Millivolt. 1×10^{-3} or 0.001 volts.
A, mA, μA	A	Amperes (amps). The unit of current.
	mA	Milliamp. 1×10^{-3} or 0.001 amperes.
	μA	Microamp. 1×10^{-6} or 0.000001 amperes.
Ω, KΩ, MΩ	Ω	Ohm. The unit of resistance.
	KΩ	Kilohm. 1×10^3 or 1000 ohms.
	MΩ	Megohm. 1×10^6 or 1,000,000 ohms.
Hz, KHz, MHz	Hz:	Hertz. The unit of frequency in cycles /second.
	KHz:	Kilohertz. 1×10^3 or 1000 hertz.
	MHz:	Megahertz. 1×10^6 or 1,000,000 hertz.
F, μF, nF	F:	Farad. The unit of capacitance.
	μF:	Microfarad. 1×10^{-6} or 0.000001 farads.
	nF:	Nanofarad. 1×10^{-9} or 0.000000001 farads.
%	%	Percent. The unit of Duty cycle.
	The input is too large for the selected range.	

2.3 Keypad

See Table 2 indicated for information about the keypad operations.

Table 2. Keypad

Key	Function	Operation performed
RANGE	V~, V, Ω , mA and μ A	Press RANGE to enter the manual ranging mode. Press RANGE to step through the ranges available for the selected function. Press and hold RANGE for 2 seconds to return to autoranging.
SELECT	\rightarrow , \circ) A, mA, and μ A Power-up Option	Switches between Diode Test and Continuity check. Switches between dc and ac current. Disables automatic power-off feature.
REL	Any switch position	Press REL to enter and exit the Relative measurement mode.
Hz / %	V~ A, mA, μ A	Press to start the frequency counter. Press again to enter duty cycle (duty factor) mode. Press again to exit the frequency counter mode.

Table 2. Keypad(continued)

Key	Function	Operation performed
HOLD	Any switch position	Press HOLD to enter and exit the Data Hold mode.
LIGHT	Any switch position	Press to turn the backlight on. The backlight will be auto-off about 5 seconds later.

2.4 Terminals

See Table 4 indicated for information about the terminals.

Table 4. Terminals

Terminal	Description
COM	Return terminal for all measurements. (Receiving the black test lead or the "com" plug of the special multi-function socket)
\rightarrow , \circ) V Ω Hz	Input for voltage, resistance, capacitance, frequency, diode and continuity measurements. (Receiving the red test lead or the "+" plug of the special multi-function socket).
hFE, μ A, mA	Input for hFE and 0.001mA to 400mA current measurements. (Receiving the red test lead or the "+" plug of the special multi-function socket)
10A	Input for 400mA to 10A current measurements. (Receiving the red test lead).

2.5 Rotary switch

A eleven-position rotary selector switch gives access to the following quantities:

- Current: 10A
- Current: mA
- Current: μ A
- DC Voltage
- AC Voltage
- OFF: off position
- Resistance
- Diode and Continuity (with beep)
- Capacitance
- Transistor: hFE
- Frequency

2.6 Accessories

Delivered with the multimeter:

• User's manual
• Test leads: 1KV 10A (model:T3000)
• Special Multi-function socket

3. FUNCTION DESCRIPTION

3.1 General Functions

3.1.1 Misconnection alarm system

The input terminals of the meter are equipped with sound and light alarms against misconnection of test leads.

At V, Ω , f and \rightarrow ranges:

1. The red lights at the "V" and "COM" terminals will be off after the test leads are plugged in.
2. The buzzer will sound upon misconnection of the test leads in the "mA" or "10A" terminals to warn the user. At the same time, the lights at the "V" and "COM" terminals will flash to remind the user to plug in the test leads there.

At μ A, mA, and hFE ranges:

1. The red lights at the "mA" and "COM" terminals will be off after the test leads are plugged in.
2. The buzzer will sound upon misconnection of the test leads in the "V" or "10A" terminals to warn the user. At the same time, the red lights at the "mA" and "COM" terminals will flash to remind the user to plug in the test leads there.

At A range:

1. The red lights at the "10A" and "COM" terminals will be off after the test leads are plugged in.
2. The buzzer will sound upon misconnection of the test leads in the "V" or "mA" terminals to warn the user. At the same time, the lights at the "10A" and "COM" terminals will flash to remind the user to plug in the test leads there.

3.1.2 DATA HOLD mode

Data Hold mode makes the meter stop updating the display. Enabling Data Hold function in autorange mode makes the meter switch to Manual ranging mode, but the full-scale range remains the same. Data Hold function can be cancelled by changing the measurement mode, pressing RANGE key, or push HOLD key again.

To enter and exit the Data Hold mode:

1. Press HOLD key (short press). Fixes the display on the current value, "H" is displayed.
2. A second short press returns the meter to normal mode.

3.1.3 Manual ranging and Autorange mode

The Meter has both manual ranging and autorange options.

- * In the autorange mode, the Meter selects the best range for the input detected. This allows you to switch test points without having to reset the range.
- * In the manual ranging mode, you select the range. This allows you to override autorange and lock the meter in a specific range.
- * The Meter defaults to the autorange mode in measurement functions that have more than one range. When the Meter is in the autorange mode, AUTO is displayed.

To enter and exit the manual range mode:

1. Press RANGE key. The Meter enters the manual ranging mode. AUTO turns off. Each presses of RANGE key increments the range. When the highest range is reached, the Meter wraps to the lowest range.

NOTE: If you manually change the measurement range after entering the Data Hold modes, the Meter exits this mode.

2. To exit the manual ranging mode, press and hold down RANGE key for two seconds. The Meter returns to the autorange mode and AUTO is displayed.

3.1.4 Battery Saver

The Meter enters the "sleep mode" and blanks the display if the Meter is on but not used for 15 minutes. Press the HOLD key or rotate the rotary switch to wake the meter up.

To disable the Sleep mode, hold down the SELECT key while turning the meter on.

One minute before power off, the beeper will sound 5 sounds. The beeper will sound again before power off.

3.1.5 Relative measurement mode

The Meter will display relative measurement in all functions except frequency.

To enter and exit the relative measurement mode:

1. With the Meter in the desired function, touch the test leads to the circuit on which you want future measurement to be based.
2. Press REL key to store the measured value and activate the relative measurement mode. The difference between the reference value and subsequent reading is displayed.
3. Press REL key for more than 2 seconds to return the Meter to normal operation.

3.2 Measurement Functions

3.2.1 AC and DC Voltage measurement

⚠ To avoid electrical shock and/or damage to the instrument, do not attempt to take any voltage measurement that might exceed 1000Vdc or 750Vac rms.

To avoid electrical shock and/or damage to the instrument, do not apply more than 1000Vdc or 750Vac rms between the common terminal and the earth ground.

The polarity of ac (alternating current) voltage varies over time; the polarity of dc (direct current) voltage is constant.

The Meter's DC voltage ranges are 400.0mV, 4.000V, 40.00V, 400.0V and 1000V; AC voltage ranges are 400.0mV, 4.000V, 40.00V, 400.0V and 750V.

(AC 400.0mV range only exists in manual ranging mode).

To measure ac or dc voltage:

1. Set rotary switch to the DCV or ACV range.
2. Connect the black and red test leads to the COM and V terminals respectively.
3. Connect the test leads to the circuit being measured
4. Read the displayed value. The polarity of red test lead connection will be indicated when making a DCV measurement.

Note:

- Unstable display may occur especially at 400mV range, even though you do not put test leads into input terminals, in this case, if an erroneous reading is suspected, short the V terminal and the COM terminal, and make sure the zero display.

- For better accuracy when measuring the dc offset of an ac voltage, measure the ac voltage first. Note the ac voltage range, then manually select a dc voltage range equal to or higher than the ac range. This improves the accuracy of the dc measurement by ensuring that the input protection circuits are not activated.

3.2.2 Resistance measurement

⚠ To avoid electrical shock and/or damage to the instrument, disconnect circuit power and discharge all high-voltage capacitors before measuring resistance.

The Meter's resistance ranges are 400.0Ω, 4.000kΩ, 40.00kΩ, 400.0kΩ, 4.000MΩ and 40.00MΩ.

To measure resistance:

1. Set the rotary switch to Ω range.
2. Connect the black and red test leads to the COM and Ω terminals respectively.
3. Connect the test leads to the circuit being measured and read the displayed value.

Some tips for measuring resistance:

- The measured value of a resistor in a circuit is often different from the resistor's rated value. This is because the Meter's test current flows through all possible paths between the probe tips.
- In order to ensure the best accuracy in measurement of low resistance, short the test leads before measurement and memory the test probe resistance in mind. This necessary to subtract for the resistance of the test leads.

- The resistance function can produce enough voltage to forward-bias silicon diode or transistor junctions, causing them to conduct. To avoid this, do not use the 40M Ω range for in-circuit resistance measurements.
- On 40M Ω range, the meter may take a few seconds to stabilize reading. This is normal for high resistance measuring.
- When the input is not connected, i.e. at open circuit, the figure "OL" will be displayed for the overrange condition.

3.2.3 Diode Test

⚠ To avoid electrical shock and/or damage to the instrument, disconnect circuit power and discharge all high-voltage capacitors before testing diodes.

Use the diode test to check diodes, transistors, and other semiconductor devices. The diode test sends a current through the semiconductor junction, then measures the voltage drop across the junction. A good silicon junction drops between 0.5V and 0.8V.

To test a diode out of a circuit:

1. Set the rotary switch to $\rightarrow \text{D}$ range.
2. Press the SELECT key to activate Diode Test.
3. Connect the black and red test leads to the COM and V Ω terminals respectively.
4. For forward-bias readings on any semiconductor component, place the red test lead on the component's anode and place the black test lead on the component's cathode.

5. The meter will show the approx. forward voltage of the diode.

In a circuit, a good diode should still produce a forward bias reading of 0.5V to 0.8V; however, the reverse-bias reading can vary depending on the resistance of other pathways between the probe tips.

3.2.4 Continuity Check

⚠ To avoid electrical shock and/or damage to the instrument, disconnect circuit power and discharge all high-voltage capacitors before testing for Continuity.

To test for continuity:

1. Set the rotary switch to $\rightarrow \text{C}$ range.
2. Press the SELECT key to activate Continuity Check.
3. Connect the black and red test leads to the COM and Ω terminals respectively.
4. Connect the test leads to the resistance in the circuit being measured.
5. When the test lead to the circuit is below 70 Ω , a continuous beeping will indicate it.

Note:

- Continuity test is available to check open/short of the circuit.

3.2.5 Transistor measurement

⚠ To avoid electrical shock and/or damage to the instrument, do not apply more than 250Vdc or 250Vac rms between the hFE terminal and the COM terminal.

To test the hFE of transistor:

1. Set the rotary switch to hFE range.
2. Connect the “com” plug and “+” plug of the special multi-function socket to the COM and hFE terminals.
3. Determine whether the transistor to be tested is NPN or PNP type and locate the Emitter, Base and Collector leads.
4. Insert leads of the transistor into proper holes of the special multi-function socket.
5. The meter will show the approx. hFE value at test condition of base current $10\mu\text{A}$ and $V_{ce} 2.8\text{V}$.

3.2.6 Capacitance measurement

⚠ To avoid electrical shock and/or damage to the instrument, disconnect circuit power and discharge all high-voltage capacitors before measuring capacitance. Use the dc voltage function to confirm that the capacitor is discharged.

Capacitance is the ability of a component to store an electrical charge.

The unit of capacitance is the farad (F). Most capacitors are in the nanofarad to microfarad range.

The Meter measures capacitance by charging the capacitor with a known current for a known period of time, measuring the resulting voltage, then calculating the capacitance. The measurement takes about 1 second per range.

The Meter's capacitance ranges are 4.000nF , 40.00nF , 400.0nF , $4.000\mu\text{F}$, $40.00\mu\text{F}$ and $200.0\mu\text{F}$.

To measure capacitance:

1. Set the rotary switch to fF range.
2. Connect the black and red test leads to the COM and fF terminals respectively. (or you can measure the capacitance by using the special Multi-Function Socket)
3. Connect the test leads to the capacitor being measured and read the displayed value.

Some tips for measuring capacitance:

- The meter may take a few seconds ($200\mu\text{F}$ range, 30 seconds) to stabilize reading. This is normal for high capacitance measuring.
- To improve the accuracy of measurements less than 4nF , subtract the residual capacitance of the Meter and leads.

3.2.7 Frequency and Duty Cycle measurement

⚠ Do not measure Frequency on high voltage (>250Vdc or 250Vac rms) to avoid electrical shock hazard and/or damage to the instrument.

To measure frequency or Duty Cycle:

A) To measure frequency by Hz range

- Set the rotary switch to Hz range.
- Connect the black and red test leads to the COM and Hz terminals respectively.
- Connect the test leads across the source or load under measurement, and read the displayed value.
- To make a duty cycle measurement, press the Hz % key again.
- Read the percent of duty cycle on the display.

Note:

- Reading is possible at input voltages above 3V rms, but the accuracy is not guaranteed.
- In noisy environment, it is preferable to use shield cable for measuring small signal.

B) To measure frequency by AC Voltage (or AC Current) range

- Set the rotary switch to the desired range (AC Voltage or AC Current).
- Connect the black and red test leads to the COM and V (or mA) terminals respectively.
- Connect the meter to the signal source; then press Hz/% key.
- For 5V logic signals (TTL), use the 4Vdc range. For 12V switching signals in automobiles, use the 40Vdc range.
- Read the frequency of the AC signal on the display.
- To make a duty cycle measurement, press the Hz % key again.
- Read the percent of duty cycle on the display.

Note:

- If the reading is 0.000Hz or is unstable, the input signal may be below or near the trigger level. These problems can frequently be fixed by selecting a lower range, which increases the sensitivity of the meter. In the DCV function, the lower ranges also have lower trigger levels.
- If a reading seems to be a multiple of what you expect, the input signal may be distorted.

Distortion can cause multiple triggering of the frequency counter. Selecting a higher voltage range might solve this problem by decreasing the sensitivity of the meter. Also, try selecting a dc range, which raises the trigger level. In general, the lowest frequency displayed is the correct one.

3.2.8 Current measurement

⚠ To avoid damage to the Meter or injury if the fuse blows, never attempt an in-circuit current measurement where the open-circuit potential to earth is greater than 250V.

To avoid damage to the meter, check the meter's fuse before proceeding. Use the proper terminals, function, and range for your measurement. Never place the probes in parallel with a circuit or component when the leads are plugged into the current terminals.

The Meter's current ranges are 400.0 μ A, 4000 μ A, 40.00mA, 400.0mA, and 10.00A.

To measure current:



1. Turn off power to the circuit. Discharge all high voltage capacitors.
2. Set the rotary switch to the μ A, mA or A range.
3. Press the SELECT key to select DCA or ACA measuring mode.
4. Connect the black test lead to the COM terminal and the red test leads to the mA terminal for a maximum of 400mA. For a maximum of 10A, move the red test lead to the 10A terminal.

5. Break the circuit path to be tested. Touch the black probe to the more negative side of the break; touch the red probe to the more positive side of the break. (Reversing the leads will give a negative reading, but will not damage the Meter.)
6. Turn on power to the circuit; then read the display. Be sure to note the measurement units at the right side of the display (μA , mA or A). When only the figure "OL" displayed, it indicates overrange situation and the higher range has to be selected.
7. Turn off power to the circuit and discharge all high voltage capacitors. Remove the Meter and restore the circuit to normal operation.

4 TECHNICAL SPECIFICATIONS

4.1 General specifications

- Environment conditions:
1000V CAT II and 600V CAT III
Pollution degree: 2
Altitude < 2000m
Operating temperature:
0~40 °C, 32 °F~122 °F (<80%RH, <10°C non-condensing)
Storage temperature:
-10~60 °C, 14°F~140°F (<70% RH, battery removed)
- Temperature Coefficient:
0.1(specified accuracy) / °C (<18°C or >28°C)
- MAX. Voltage between terminals and earth ground:
750V AC rms or 1000V DC.
- Fuse Protection:
 μA and mA : Resettable fuse(400mA/250V);

- 10A: F 10A/250ØV 6.3x32 mm.
- Sample Rate: 3 times/sec for digital data.
 - Display:
3 3/4 digits LCD display. Automatic indication of functions and symbols.
 - Range selection: automatic and manual.
 - Over Range indication: LCD will display "OL".
 - Low battery indication:
The " " is displayed when the battery is under the proper operation range.
 - Polarity indication: " — " displayed automatically.
 - Power source: DC 4.5V 
 - Battery type: 1.5V AAA.
 - Dimensions: 195 × 92 × 55 mm.
 - Weight: 400g. Approx. (battery included)

4.2 Measurement specifications

Accuracy is specified for one year after calibration, at operating temperatures of 18°C to 28°C, with relative humidity at 0% to 75%.

Accuracy specifications take the form of: \pm (% of Reading + Number of Least Significant Digits)

4.2.1 DC Voltage

Range	Resolution	Accuracy
400mV	0.1mV	$\pm(0.7\% \text{ of rdg} + 2 \text{ digits})$
4V	1mV	
40V	10mV	
400V	100mV	
1000V	1V	$\pm(0.8\% \text{ of rdg} + 2 \text{ digits})$

Input impedance: 10M Ω

Max. input voltage: 1000Vdc or 750V ac rms.

4.2.2 AC Voltage

Range	Resolution	Accuracy
400mV	0.1mV	$\pm(3.0\%$ of rdg +3 digits)
4V	1mV	$\pm(0.8\%$ of rdg +3 digits)
40V	10mV	
400V	100mV	
750V	1V	$\pm(1.0\%$ of rdg +3 digits)

Input impedance: 10M Ω

Max. input voltage: 1000Vdc or 750V ac rms.

Frequency Range: 40Hz-200Hz for 4V range,
40Hz-1kHz for other ranges.

Response: Average, calibrated in rms of sine wave

4.2.3 Resistance

Range	Resolution	Accuracy
400.0 Ω	0.1 Ω	$\pm(1.2\%$ of rdg +2 digits)
4.000K Ω	1 Ω	
40.00K Ω	10 Ω	
400.0K Ω	100 Ω	
4.000M Ω	1K Ω	
40.00M Ω	10K Ω	$\pm(2.0\%$ of rdg +5 digits)

Open Circuit Voltage: approx. 250mV.

Overload protection: 250V dc or 250Vac rms.

4.2.4 Audible continuity

Range	Continuity beeper
	$\leq 70\Omega$

Open circuit voltage: approx. 0.5V.

Overload protection: 250Vdc or 250Vac rms.

4.2.5 Diode

Range	Resolution	Function
	1mV	Display read approx. forward voltage of diode

Forward DC Current: approx. 1mA

Reversed DC Voltage: approx. 1.5V

Overload protection: 250Vdc or 150Vac rms.

4.2.6 Transistor

Range	Description	Test Condition
hFE	Display read approx. HFE value (0-1000) of transistor under test (all type).	Base Current approx. 10 μ A, Vce approx. 2.8V.

Overload protection: Resettable Fuse (F400mA/250V)

4.2.7 Capacitance

Range	Resolution	Accuracy
4nF	1pF	$\pm(5.0\%$ of rdg +5 digits)
40nF	10pF	$\pm(3.0\%$ of rdg +3 digits)
400nF	100pF	
4 μ F	1nF	
40 μ F	10nF	
200 μ F	100nF	

Overload protection: 250V dc or 250Vac rms.

4.2.8 Frequency

Range	Resolution	Accuracy
9.999Hz	0.001 Hz	

99.99Hz	0.01 Hz	±(2.0% of rdg +5 digits)
999.9Hz	0.1 Hz	
9.999kHz	1 Hz	
99.99kHz	10 Hz	
199.9kHz	100 Hz	
>200kHz	100 Hz	Unspecified @ >200kHz

- By Hz range:

Overload protection: 250V dc or 250V ac rms.
 Input Voltage range: 0.6V-3V ac rms (Input voltage must be enlarged with increasing frequency under measurement)

Frequency Response: 10Hz-200kHz, sine wave.
 0.5Hz-200kHz, square wave.

- By AC Voltage range:

Input Voltage range: 1V-750Vac rms (Input voltage must be enlarged with increasing frequency under measurement)

Frequency Response: 1Hz-10kHz, sine wave.
 Maximum input voltage: 1000V dc or 750V ac rms.
 Input impedance: 10MΩ

- By AC Current range:

Input current range: 5μA -4000μA ac rms for μA range
 5mA-400mA ac rms for mA range.
 (Input current must be enlarged with increasing frequency under measurement)
 Frequency Response: 1Hz-10kHz, sine wave.
 Maximum input current: 400mA dc or 400mA ac rms for μA and mA ranges.

4.2.9 DC CURRENT

Range	Resolution	Accuracy
400μA	0.1μA	±(1.2% of rdg +3 digits)
4000μA	1μA	
40mA	0.01mA	
400mA	0.1mA	
10A	10mA	±(2.0% of rdg +5 digits)

Overload protection: F 10A/250V fuse for 10A range.
 Resettable fuse(F400mA/250V) for μA and mA ranges.

Maximum input current: 400mA dc or 400mA ac rms for μA and mA ranges, 10A dc or 10A ac rms for 10A ranges.

For measurements>5A, 4 minutes maximum ON to measure 10 minutes OFF.

4.2.10 AC CURRENT

Range	Resolution	Accuracy
400μA	0.1μA	±(1.5% of rdg +5 digits)
4000μA	1μA	
40mA	0.01mA	
400mA	0.1mA	
10A	10mA	±(3.0% of rdg +7 digits)

Overload protection: F 10A/250V fuse for 10A range.
 Resettable fuse(400mA/250V) for μA and mA ranges.

Maximum input current: 400mA dc or 400mA ac rms for μA and mA ranges, 10A dc or 10A ac rms for 10A ranges.

Frequency Range: 40Hz-1kHz
Response: Average, calibrated in rms of sine wave
For measurements >5A, 4 minutes maximum ON to measure 10 minutes OFF.

4.2.11 DUTY CYCLE

Range	Resolution	Accuracy
5%~95%	0.1%	±(2.0% + 2)

5. MAINTENANCE

This section provides basic maintenance information, including fuse and battery replacement instructions. Do not attempt to repair or service your Meter unless you are qualified to do so and have the relevant calibration, performance test, and service information.

5.1 General Maintenance

⚠ To avoid electrical shock or damage to the meter, do not get water inside the case. Remove the test leads and any input signals before opening the case

Periodically wipe the case with a damp cloth and mild detergent. Do not use abrasives or solvents.

Dirt or moisture in the terminals can affect readings.

To clean the terminals:

- Turn the meter off and remove all test leads.
- Shake out any dirt that may be in the terminals.
- Soak a new swab with a cleaning and oiling agent (such as WD-40).
- Work the swab around in each terminal. The oiling agent insulates the terminals from moisture-related contamination.

5.2 Fuse replacement

⚠ Before replacing the fuse, disconnect test leads and/or any connectors from any circuit under test. To prevent damage or injury, replace the fuse only with specified ratings.

To replace the Meter's fuse (see Figure 2.):

1. Set rotary switch to the OFF position.
2. Disconnect test leads and/or any connectors from the terminals.
3. Use a screwdriver to unscrew the two screws secured on the battery cover.
4. Take out the battery cover from the meter.
5. Remove the fuse by gently prying one end loose, then sliding the fuse out of its bracket.
6. Install the replacement fuses only with specified ratings: F 10A/250V Ø6.3×32
7. Rejoin the battery cover and secure by the two screws.

5.3 Battery replacement

⚠ To avoid false readings, which could lead to possible electric shock or personal injury, replace the battery as soon as the battery indicator () appears. Before replacing the battery, disconnect test leads and/or any connectors from any circuit under test, turn the meter off and remove test leads from the input terminals.

To replace the battery (see Figure 2.):

1. Set rotary switch to the OFF position.
2. Disconnect test leads and/or any connectors from the terminals.

3. Use a screwdriver to unscrew the two screws secured on the battery cover.
4. Take out the battery cover from the meter.
5. Remove the used batteries.
6. Replace with three new 1.5V batteries (AAA).
7. Rejoin the battery cover and secure by the two screws.

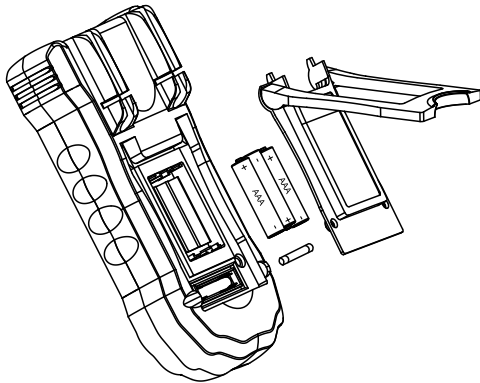

Figure 2. Battery and Fuse Replacement

⚠ CAUTION:

“Using this appliance in an environment with a strong radiated radio-frequency electromagnetic field (approximately 3V/m), may influence its measuring accuracy. The measuring result can be strongly deviating from the actual value”

