

PRICE LIST

Bioclimatic Pergola



Index

4	Our manifesto
6	Timeline
8	What are our fundamental values?
10	Outdoor living comfort
11	Why choose Bioclimatic Pergola?
14	Configurations
15	Colours
16	Dimensions and characteristics
18	Model configurations
20	Blade performance
21	Value proposition
PRICE LIST	
22	Bioclimatic Pergola SL 160/28
24	Bioclimatic Pergola SL 170/28
26	Bioclimatic Pergola SL 170/36
28	Bioclimatic Pergola SL 240/36
30	Bioclimatic Pergola SL 240/60
32	Cabrio Bioclimatic Pergola RT 240/36
34	Price calculation simulation
OPTIONS PRICE LIST	
37	ZIP roller blinds
38	Glass panels
40	Sliding panels (wood, alu)
43	Glass roof
44	Roof types
45	Special water evacuation
46	Wall mounting
47	Foot mounting
48	Accessories
49	How to understand the markings
50	Order form
55	Technical description of the Bioclimatic Pergola system
56	Wind resistance
59	General Sales Conditions and warranty
62	Patent
64	Our products
68	Contact

Our manifesto



Soltec. *More life.*

SOL TEC

There is no life without sun and that is why the sun is the core of our name. It is not only part of our name, but it also represents actions, values, thinking, purpose, ideas and more. **We love the sun and we love life.** Above all, we strive to make people around us feel the same way.

We are aware that every day cannot be sunny, and even on a sunny day, we still need the help of a shadow.

That is why the other half of the Soltec name represents technology, development and perfection of solutions that transform an unstable external environment into quality spaces of reliable safety, functionality and superior living comfort, which constantly give people a feeling and confirmation that life is beautiful.

And we want more of that life.

WHO ARE WE?

Energy, curiosity and a desire to create new products make us feel alive. **Self-confidence, perseverance and knowledge** give us strength and stability in solving even the most demanding challenges.

Tidiness, care and a sense of aesthetics have become important aspects of our work, as we always strive to make the people around us feel good.

HOW DO WE WORK?

At Soltec, the well-being of people is important, so we try to look at every situation from a positive point of view. We spread knowledge and information on how to achieve **superior living comfort, while at the same time inspiring people to recognize everything beautiful, comfortable and of high quality.**

Timeline



OUR STORY

The beginnings of Soltec date back to the 1999, when engineer Mirko Požar opened a small workshop in Slovenia for the production of blinds. His entrepreneurship, ability to perceive opportunities and development orientation are the reasons why the company has become a real source of developing innovative shading solutions.

With the right vision and hard work, Soltec developed into **the most important developer and manufacturer of innovative and quality shading solutions in the region.**

Today, Soltec's most important products are bioclimatic pergolas, multiports of all kinds (carports, glassports, aluports greenports), outdoor kitchens, waste enclosures, and various architectural shading systems.

Despite its rapid growth, Soltec maintains the values of a family business. We are especially proud of the high level of trust on the international market.

Today, our mission is to help you **improve and increase your living space, raising the level of comfort, safety and functionality with products that are made with you and just for you.**

2017

Sliding panels

2018

Folding panels

2019

Lifting panels
4 000 m² of
new production
capacities

2020

Carport

2021

Glassport

2024

Bioclimatic
pergola
Cabrio
Carport with
Solar Pack
Greenport
Outdoor
kitchen
Waste
enclosure

*WELCOME TO SOLTEC, TO WORLD
OF HIGH LIVING COMFORT.*

*“ We are committed to the
promise that with Soltec outdoor
products, we will transform
exteriors into high-quality, safe
and comfortable spaces, and
always put customers at the
center of our operations. ”*

Mirko Požar
CEO

What are our fundamental values?

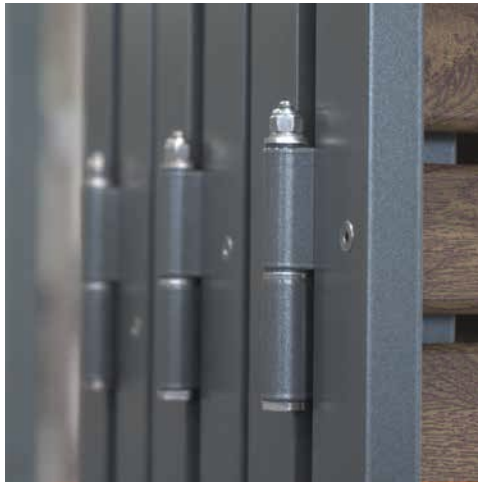

RELIABILITY.

With perseverance and honesty we fulfill all our agreements. If we encounter challenges along the way, we always find solutions to them, so our colleagues and partners can rely on us.

EXCELLENCE.

We are constantly upgrading our knowledge and competencies and thus pushing the boundaries of the known. Each of us does our job in a quality and timely manner, ensuring that our products and services are to the great satisfaction of our customers.

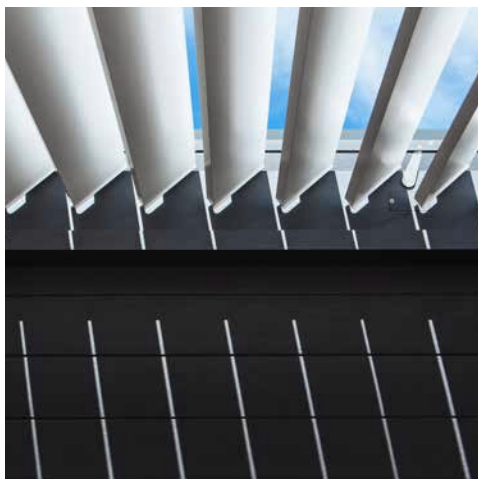

INNOVATION.

We are creators of change and we create novelties with passion. We learn and create with you and for you. With new approaches, we are paving different paths so that our products are always functional and modernly designed, and the solutions are bold and personalized only for you.

PARTNERSHIP.

We build respectful relationships between employees and partners. Each of us takes on personal responsibility for our own success, for the success of the project, department and company. At the same time, we are distinguished by our team spirit, as we know how to help each other to achieve the set goals together.



CONFIDENCE.

We are honest with each other. We do what we think and say. We stand by our clients and work with them to find the best solutions. We believe in ourselves, in our colleagues and partners, so we are confident in our joint success.



Outdoor living comfort

Regulate the **temperature**, control **sunlight**,

protect yourself from **rain* & snow***, extend the outdoor season.

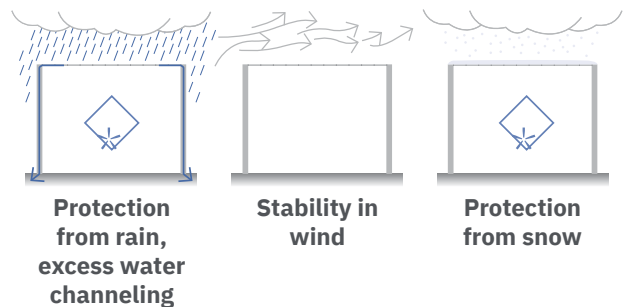
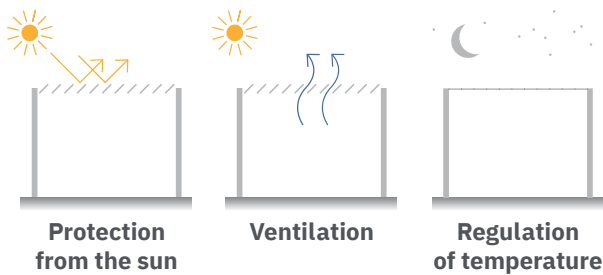

COMFORT OF PERGOLA ACCESSORIES

Personalize your pergola by choosing among many options integrated in the structure to optimize your comfort:



Lighting



Heaters



Speakers



Sliding Panels



Glass Panels



ZIP Rollos

10 reasons why choose Bioclimatic Pergola

40 m²

Best value proposition for covering outdoor space up to 40m²



Made from the best materials



Made in Europe



Technically and aesthetically perfected solution



Patented waterproof blade



Invisible fixings



After sales support and education



Simple and fast installation



Simple ordering system and tracing of the project via web configurator



Wide range of accessories

DESIGN & INNOVATION

Our design office is constantly on the lookout for new products and improvements in order to offer you perfectly suited products at the right price. Our attention to detail makes it possible for us to create pergolas with careful finishes:

Invisible fixings



LED lights incorporated in the blades



Evacuation of water concealed in the structure

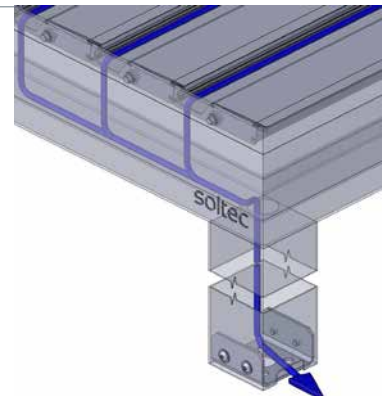





Configurations

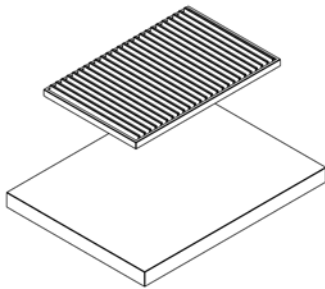

TYPE 0
No poles

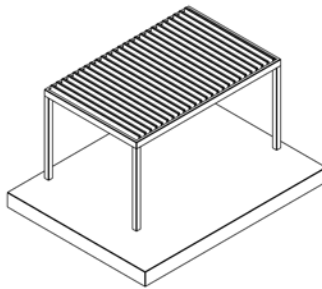

TYPE 1
Self-standing

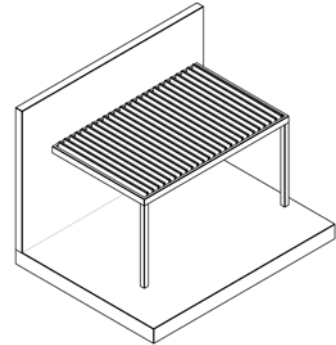

TYPE 2
Wall-mounted, blades perpendicular to the wall

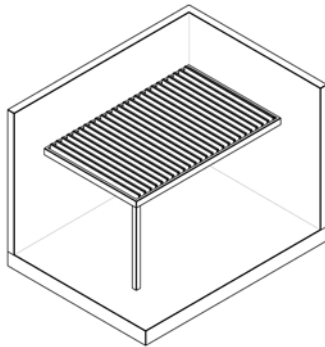

TYPE 3
Wall-mounted on two sides, blades perpendicular to the wall

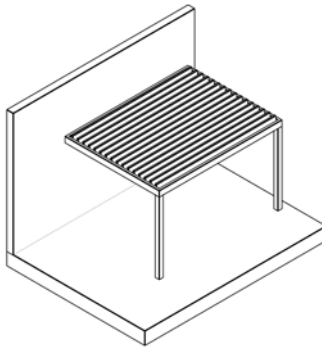

TYPE 4
Wall-mounted, blades parallel to the wall

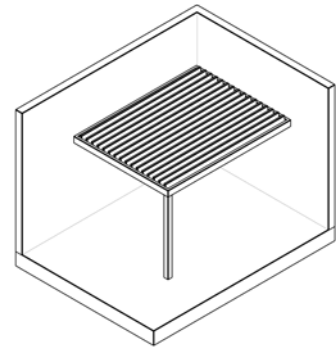

TYPE 5
Wall-mounted, blades parallel to the wall

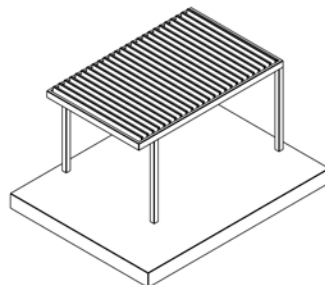

TYPE 6
Self-standing, poles offset

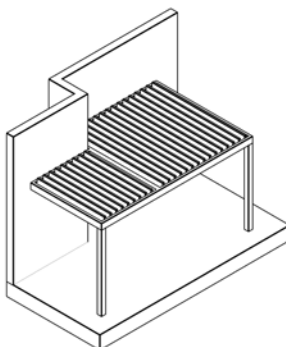



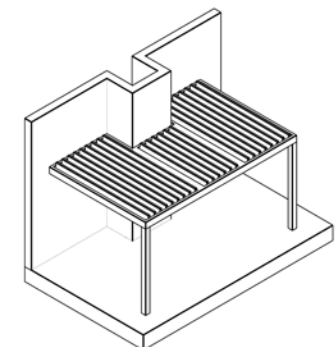





TYPE 7
Wall-mounted, S-shaped (not suitable for Cabrio pergola)



TYPE 8
Wall-mounted, U-shaped (not suitable for Cabrio pergola)

Colours

	Colours	Surface	
Standard	 Anthracite Grey RAL 7016FS	Fine structure	
	 Aluminium Grey RAL 9007FS	Fine structure	
	 Aluminium White RAL 9006FS	Fine structure	
	 Traffic White RAL 9016FS	Fine structure	
	 Oyster White RAL 1013FS	Fine structure	
	 Chocolate Brown RAL 8017FS	Fine structure	
	 RAL DB703FS	Fine structure	
Optional	<p>Customize your Bioclimatic Pergola by selecting the color of your choice from more than 1600 existing RAL colors, different glossy and finishing standard.*</p> <p>RAL 1000 > RAL 9023</p> 	<p>Different gloss levels are available.*</p> <p>Gloss levels: < 30 % matt > 65 % satin > 80 % gloss</p>	<p>Different microstructure available.*</p> <p>Microstructure: Fine structural powder coating (deep matt)</p>

*Subject to additional payment. Gloss levels are +/- 5 % accurate.

Dimensions & Characteristics

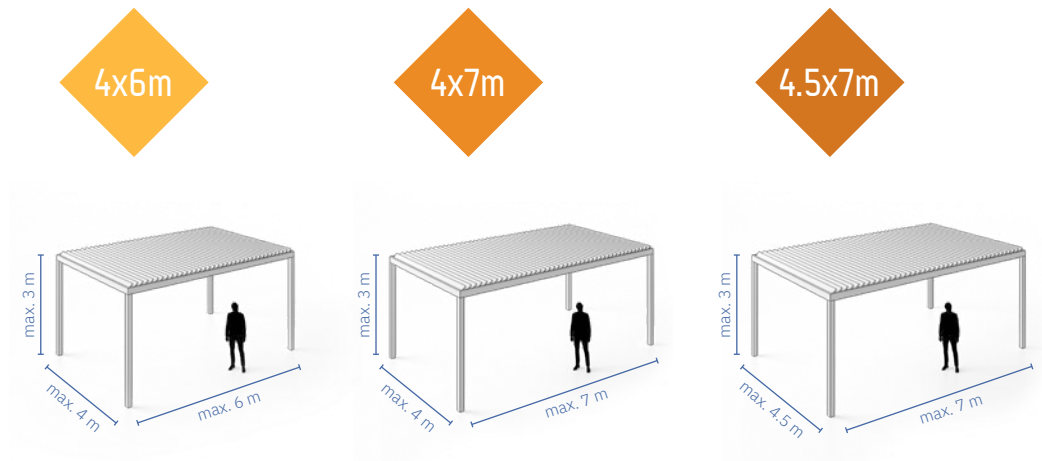

Bioclimatic Pergola
SL 160/28

PROFILE 16
S BLADE

Bioclimatic Pergola
SL 170/28

PROFILE 17
S BLADE

Bioclimatic Pergola
SL 170/36

PROFILE 17
L BLADE

Blades	200/28	200/28	200/36
Profile	160/120	170/120	170/120
Poles	120/120	120/120	120/120
Max dimension 1 module	4 x 6 m	4 x 7 m	4.5 x 7 m
Installation - 4 poles	Self standing	Self standing	Self standing
Installation - up to 3 poles	Wall mounting	Wall mounting	Wall mounting
Foot type	Internal / external	Internal / external	Internal / external
Water exit	Standard / option	Standard / option	Standard / option
N° of water exit	2	2	2
Motorisation	1 motor	1 motor / 2 motors	1 motor / 2 motors

* on length above 6 m additional pole has to be installed

* on length above 6 m additional pole has to be installed

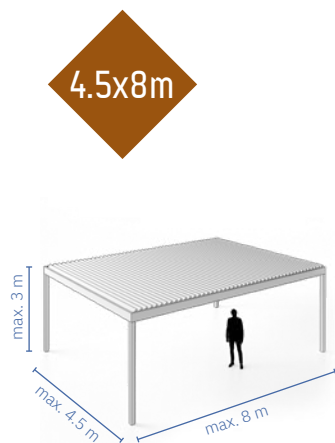

**Bioclimatic Pergola
SL 240/36**

**PROFILE 24
L BLADE**

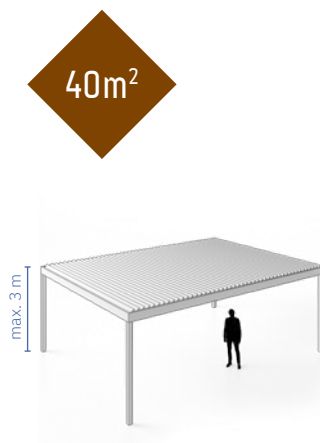

**Bioclimatic Pergola
SL 240/60**

**PROFILE 24
XL BLADE**

RETRACTABLE

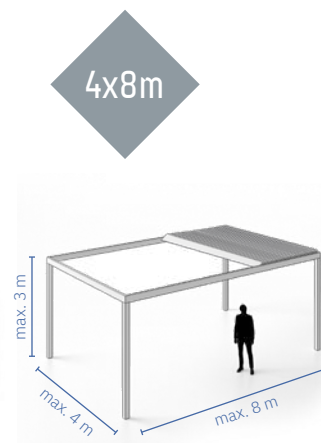

**Cabrio Bioclimatic Pergola
RT 240/36**

**PROFILE 17
L BLADE**

Blades	200/36	270/60	200/36
Profile	240/150	240/150	240/150
Poles	150/150	150/150	150/150
Max dimension 1 module	4.5 x 8 m	6 x 6 m, 5 x 8 m, max. 40 m ²	4 x 8 m
Installation - 4 poles	Self standing	Self standing	Self standing
Installation - up to 3 poles	Wall mounting	Wall mounting	Wall mounting
Foot type	External	External	External
Water exit	Standard / option	Standard / option	Standard / option
N° of water exit	2 / 3	2 / 3	2 / 3
Motorisation	1 motor / 2 motors	1 motor / 2 motors	3 motors

* on length above 6 m additional pole has to be installed

Model configurations

Bioclimatic Pergola
SL 160/28

Bioclimatic Pergola
SL 170/28

Bioclimatic Pergola
SL 170/36

Profiles

PROFILE 16

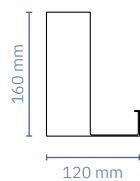

PROFILE 17

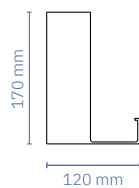

PROFILE 17

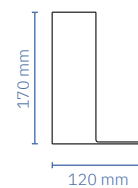

Blades

S BLADE

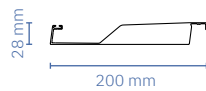

S BLADE

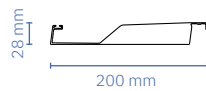

L BLADE

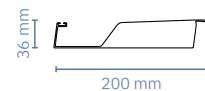

Poles

POLES

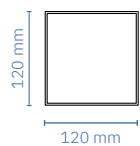

POLES

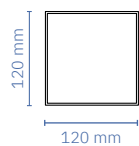

POLES

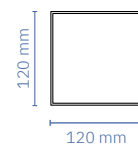

Aluminium profiles, blades, and poles. All standard parts are produced in inox.

**Bioclimatic
Pergola
SL 240/36**

**Bioclimatic
Pergola
SL 240/60**

**Cabrio
Bioclimatic
Pergola
RT 240/36**

Profiles

PROFILE 24

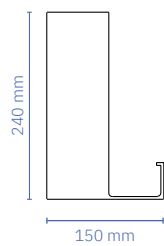

PROFILE 24

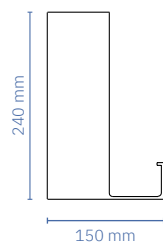

PROFILE RT24

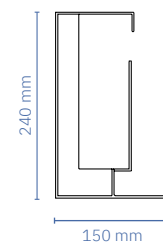

Blades

L BLADE

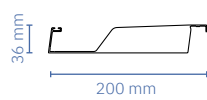

XL BLADE

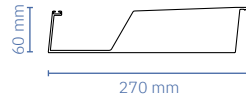

L BLADE

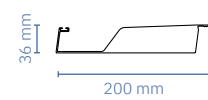

Poles

POLES

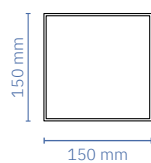

POLES

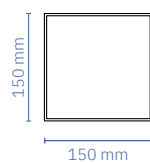

POLES

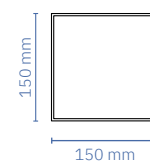

Blade performance

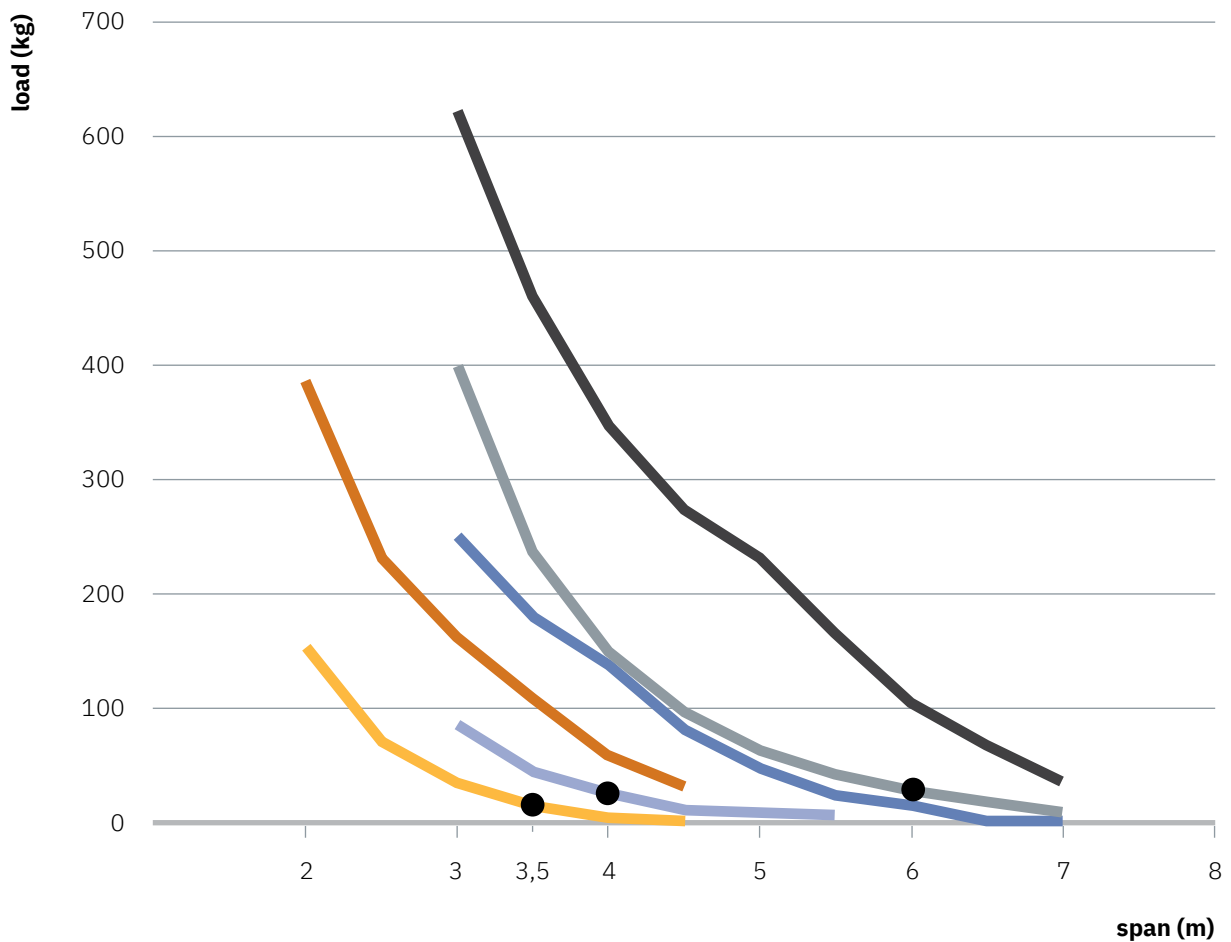

- **SL28 blade / capacity**
- **SL28 blade / functional**
- **SL36 blade / capacity**
- **SL36 blade / functional**
- **XL60 blade / capacity**
- **XL60 blade / functional**

The Maximum Possible Load chart is intended for user instructions providing information as with regards to the maximum static load capacity of the structure for the specific dimensions of the rotating blades. The two lines represent two limit load levels. The lower as the Functional level (operation is not affected deformation L/200 is reached where L is the length of the blade) and the higher as the Capacity level (80% material capacity reached - operation can be affected). In case of snow and for any other possible loads, it is recommended to remove any elements from the structure before operating. Customers should regularly check and remove objects that might affect the operation of the structure or reduce its water discharge capacity. It is advisable to take at least 30 kg of additional load into consideration to take into account the specific environmental loads. Advisable max length of the SL28 blade is 3.5 m and for the SL36 blade is 4 m.

Value proposition

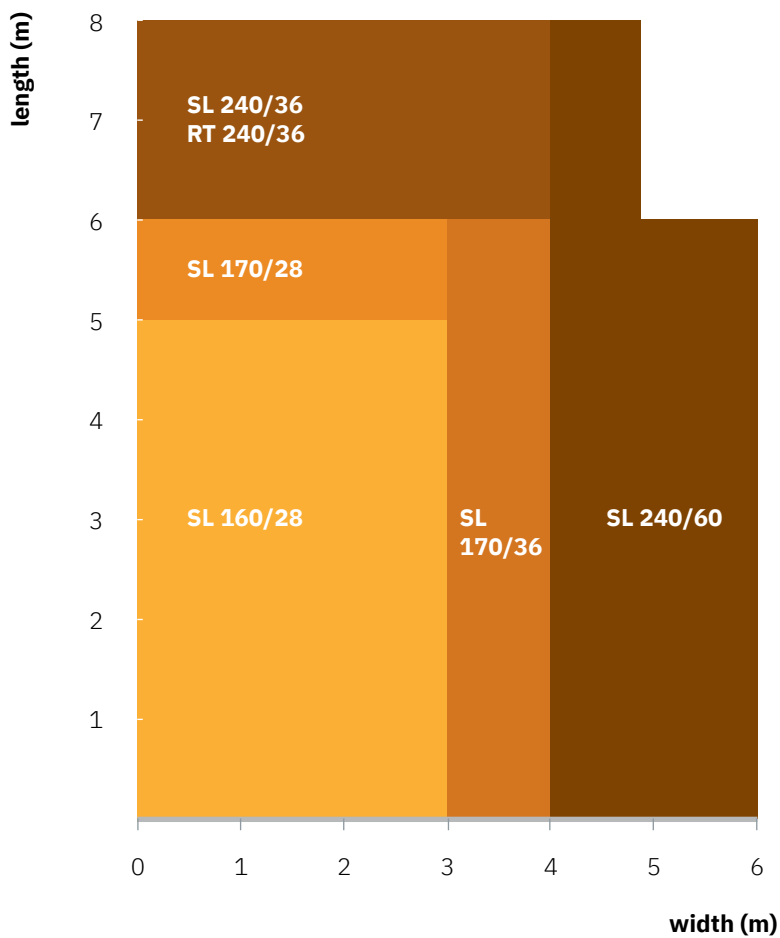

We offer best value proposition for covering outdoor space up to 40m² with five different models to achieve best ratio price performance.

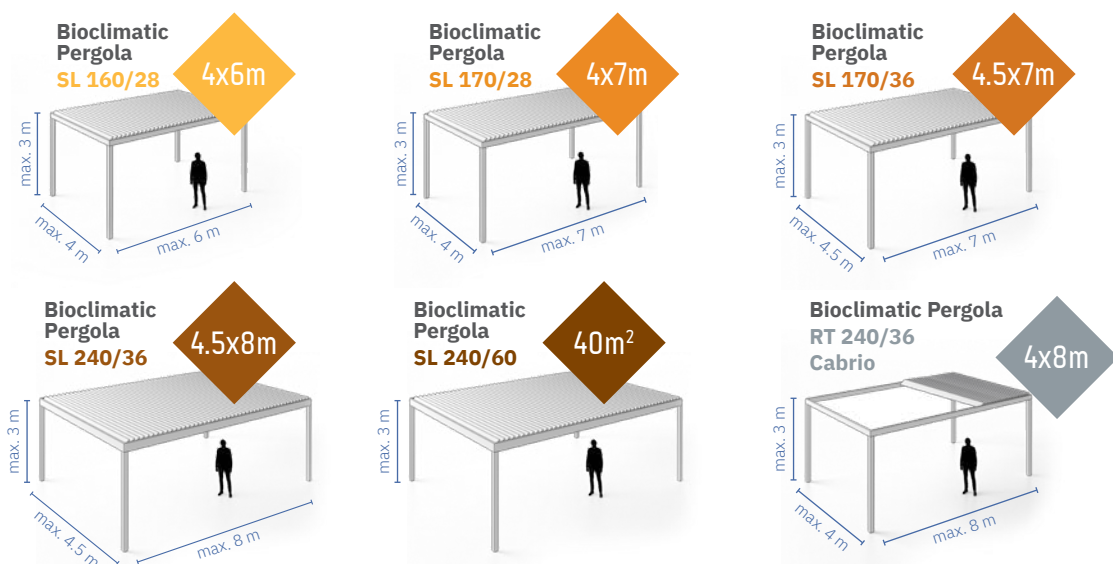

Price list

Soltec **Bioclimatic Pergola**

SL 160/28

Pergola high up to 3 m

ZIP roller blind [mm]	1260	1760	2260	2760	3260	3760
€/unit	1.501 €	1.654 €	1.754 €	1.906 €	2.006 €	2.158 €

Pergola high up to 3 m		Pergola length [mm]						Blades	
ZIP roller blind [mm]	€/unit	1500	2000	2500	3000	3500	4000		
819	1.407 €	1059	5.033 €	5.197 €	5.410 €	5.562 €	5.755 €	6.131 €	5
1002	1.450 €	1242	5.172 €	5.345 €	5.588 €	5.755 €	5.987 €	6.354 €	6
1184	1.501 €	1424	5.308 €	5.497 €	5.763 €	5.947 €	6.225 €	6.611 €	7
1367	1.550 €	1607	5.446 €	5.648 €	5.937 €	6.142 €	6.314 €	6.750 €	8
1549	1.601 €	1789	5.577 €	5.802 €	6.115 €	6.339 €	6.560 €	6.984 €	9
1732	1.654 €	1972	5.695 €	5.951 €	6.295 €	6.538 €	6.809 €	7.225 €	10
1915	1.703 €	2155	5.835 €	6.104 €	6.473 €	6.731 €	7.053 €	7.464 €	11
2097	1.732 €	2337	5.969 €	6.252 €	6.657 €	6.928 €	7.295 €	7.710 €	12
2280	1.754 €	2520	6.113 €	6.399 €	6.837 €	7.126 €	7.543 €	7.973 €	13
2462	1.805 €	2702	6.241 €	6.552 €	7.019 €	7.326 €	7.793 €	8.227 €	14
2645	1.855 €	2885	6.371 €	6.703 €	7.203 €	7.523 €	8.144 €	8.629 €	15
2828	1.906 €	3068	6.485 €	6.852 €	7.381 €	7.744 €	8.397 €	8.900 €	16
3010	1.956 €	3250	6.619 €	7.002 €	7.563 €	7.944 €	8.630 €	9.155 €	17
3193	2.006 €	3433	6.659 €	7.152 €	7.744 €	8.111 €	8.854 €	9.368 €	18
3375	2.058 €	3615	6.789 €	7.302 €	7.926 €	8.242 €	8.917 €	9.431 €	19
3558	2.110 €	3798	7.043 €	7.595 €	8.259 €	8.701 €	9.360 €	9.877 €	20
3741	2.158 €	3981	7.124 €	7.662 €	8.432 €	8.909 €	9.598 €	10.048 €	21
3923	2.209 €	4163	7.189 €	7.723 €	8.578 €	9.050 €	9.808 €	10.478 €	22
4106	2.245 €	4346	7.276 €	7.813 €	8.686 €	9.179 €	10.006 €	10.848 €	23
4288	2.270 €	4528	7.391 €	7.937 €	8.797 €	9.324 €	10.202 €	11.052 €	24
4471	2.319 €	4711	7.548 €	8.085 €	8.996 €	9.529 €	10.440 €	11.236 €	25
4654	2.372 €	4894	7.694 €	8.238 €	9.179 €	9.716 €	10.621 €	11.413 €	26
4836	2.423 €	5076	7.812 €	8.518 €	9.448 €	10.070 €	10.917 €	11.662 €	27
5019	2.474 €	5259	7.885 €	8.621 €	9.581 €	10.324 €	11.173 €	11.943 €	28
5201	2.521 €	5441	8.089 €	8.826 €	9.741 €	10.475 €	11.391 €	11.971 €	29
5384	2.561 €	5624	8.216 €	8.945 €	9.898 €	10.611 €	11.583 €	11.986 €	30
5567	2.608 €	5807	8.368 €	9.043 €	10.071 €	10.754 €	11.787 €	12.008 €	31
5749	2.654 €	5989	8.497 €	9.141 €	10.245 €	10.898 €	12.003 €	12.039 €	32



OBLIGATORY

Pergola inclination on length toward water exit:

15 mm, if not use ZIP rolo or use additional post.



OBLIGATORY

Pergola inclination on width toward water exit:

5 mm | 5 mm | 10 mm | 15 mm | 20 mm | 30 mm

ZIP rolo, sliding or glass panels not possible to install - use another pergola model.

INCLUDED IN PRICE: Structure and blades in standard RAL or bicolor, motor, control unit, remote control Teleco, standard mounting, wiring, power supply TRAF0 220 AC / 24 DC. Prices are defined and expressed in EUR. The prices are always before VAT. Any discounts shall be agreed upon in written form. The prices are ex-works Soltec headquarters. Packaging excluded.

Technical details

Soltec Bioclimatic Pergola

SL 160/28

Blades	200/28
Profile	160/120
Poles	120/120
Max dimension 1 module	4 x 6 m
Installation - 4 poles	Self standing
Installation - up to 3 poles	Wall mounting
Foot type	Internal / external
Water exit	Standard / option
N° of water exit	2
Motorisation	1 motor

PROFILE 16

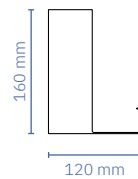

S BLADE

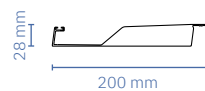

POLES

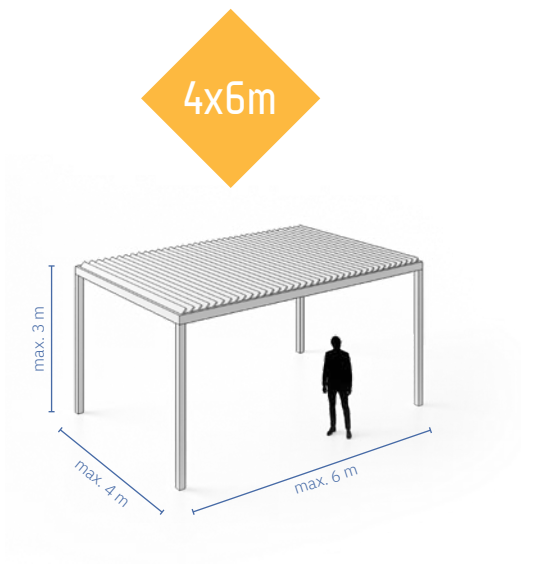
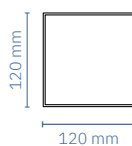

HIGH CORROSION RESISTANCE

Frame and all standard mechanical parts are made exclusively of aluminium and stainless steel.

PERGOLA FUNCTIONALITY LOAD (kg/m²)

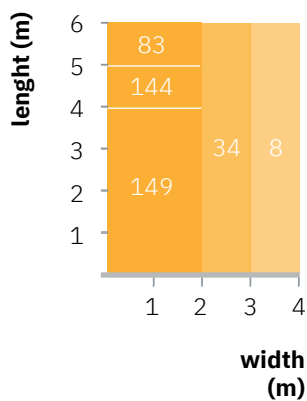

BLADE PERFORMANCE

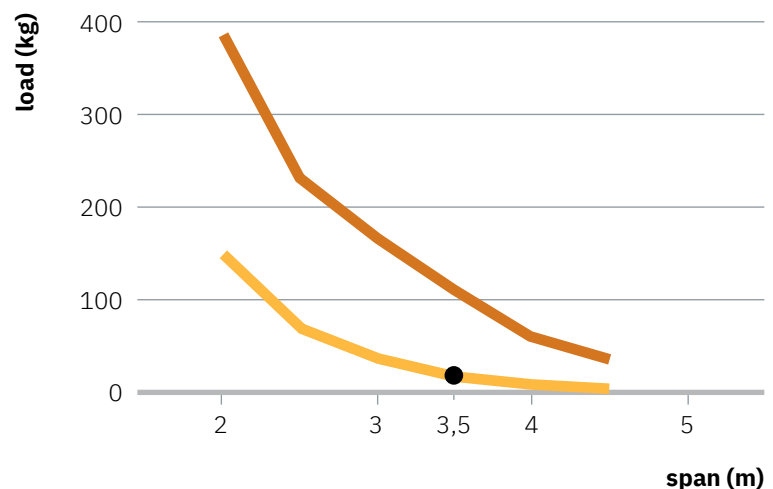

— SL28 blade / capacity

— SL28 blade / functional

● recommended maximal width in most countries

Price list

Soltec Bioclimatic Pergola

SL 170/28

Pergola high up to 3 m

ZIP roller blind [mm]	1260	1760	2260	2760	3260	3260	>3760
€/unit	1.501 €	1.654 €	1.754 €	1.906 €	2.006 €	2.158 €	2.328 €

Pergola high up to 3 m

ZIP roller blind [mm]	€/unit
1002	1.450 €
1184	1.501 €
1367	1.550 €
1549	1.601 €
1732	1.654 €
1915	1.703 €
2097	1.732 €
2280	1.754 €
2462	1.805 €
2645	1.855 €
2828	1.906 €
3010	1.956 €
3193	2.006 €
3375	2.058 €
3558	2.110 €
3741	2.158 €
3923	2.209 €
4106	2.245 €
4288	2.270 €
4471	2.319 €
4654	2.372 €
4836	2.423 €
5019	2.474 €
5201	2.521 €
5384	2.561 €
5567	2.608 €
5749	2.654 €

Pergola length [mm]	Pergola width [mm]						Blades
	1500	2000	2500	3000	3500	4000	
1242	5.832 €	6.028 €	6.301 €	6.487 €	6.750 €	7.164 €	6
1424	5.984 €	6.199 €	6.499 €	6.705 €	7.017 €	7.455 €	7
1607	6.140 €	6.369 €	6.696 €	6.925 €	7.118 €	7.611 €	8
1789	6.288 €	6.542 €	6.895 €	7.147 €	7.396 €	7.874 €	9
1972	6.420 €	6.711 €	7.097 €	7.370 €	7.676 €	8.147 €	10
2155	6.578 €	6.882 €	7.297 €	7.591 €	7.953 €	8.416 €	11
2337	6.729 €	7.048 €	7.505 €	7.810 €	8.224 €	8.692 €	12
2520	6.892 €	7.215 €	7.708 €	8.035 €	8.504 €	8.989 €	13
2702	7.036 €	7.388 €	7.915 €	8.259 €	8.786 €	9.277 €	14
2885	7.183 €	7.558 €	8.120 €	8.482 €	9.182 €	9.727 €	15
3068	7.311 €	7.726 €	8.322 €	8.729 €	9.469 €	10.035 €	16
3250	7.461 €	7.894 €	8.527 €	8.957 €	9.730 €	10.321 €	17
3433	7.507 €	8.063 €	8.730 €	9.146 €	9.982 €	10.563 €	18
3615	7.654 €	8.232 €	8.934 €	9.291 €	10.052 €	10.632 €	19
3798	7.940 €	8.563 €	9.312 €	9.810 €	10.552 €	11.135 €	20
3981	8.030 €	8.638 €	9.507 €	10.044 €	10.823 €	11.328 €	21
4163	8.105 €	8.707 €	9.671 €	10.204 €	11.059 €	11.812 €	22
4346	8.204 €	8.810 €	9.793 €	10.349 €	11.282 €	12.231 €	23
4528	8.334 €	8.948 €	9.918 €	10.511 €	11.502 €	12.462 €	24
4711	8.510 €	9.116 €	10.143 €	10.743 €	11.770 €	12.668 €	25
4894	8.676 €	9.286 €	10.349 €	10.955 €	11.977 €	12.865 €	26
5076	8.809 €	9.604 €	10.653 €	11.353 €	12.309 €	13.148 €	27
5259	8.888 €	9.719 €	10.803 €	11.640 €	12.597 €	13.465 €	28
5441	9.120 €	9.951 €	10.982 €	11.811 €	12.843 €	13.497 €	29
5624	9.264 €	10.084 €	11.158 €	11.963 €	13.059 €	13.515 €	30
5807	9.435 €	10.196 €	11.355 €	12.126 €	13.288 €	13.807 €	31
5989	9.579 €	10.307 €	11.552 €	12.288 €	13.533 €	13.900 €	32
6172	10.982 €	11.740 €	12.923 €	13.640 €	14.923 €	15.237 €	33
6354	11.108 €	11.861 €	13.049 €	13.947 €	15.114 €	15.548 €	34
6537	11.272 €	12.017 €	13.224 €	14.087 €	15.230 €	16.035 €	35
6720	11.409 €	12.177 €	13.354 €	14.258 €	15.401 €	16.399 €	36
6902	11.547 €	12.318 €	13.489 €	14.399 €	15.569 €	16.925 €	37

OBLIGATORY

Pergola inclination on length toward water exit:

15 mm, or use additional post.

OBLIGATORY Pergola inclination on width toward water exit:

0 mm	0 mm	5 mm	10 mm	15 mm	20 mm
------	------	------	-------	-------	-------

Blade inclined in frame for 9 mm.

INCLUDED IN PRICE: Structure and blades in standard RAL or bicolor, motor, control unit, remote control Teleco, standard mounting, wiring, power supply TRAF0 220 AC / 24 DC. Prices are defined and expressed in EUR. The prices are always before VAT. Any discounts shall be agreed upon in written form. The prices are ex-works Soltec headquarters. Packaging excluded.

Technical details

Soltec Bioclimatic Pergola

SL 170/28

Blades	200/28
Profile	170/120
Poles	120/120
Max dimension 1 module	4 x 7 m
Installation - 4 poles	Self standing
Installation - up to 3 poles	Wall mounting
Foot type	Internal / external
Water exit	Standard / option
N° of water exit	2
Motorisation	1 / 2 motors

PROFILE 17

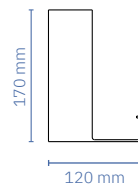

S BLADE

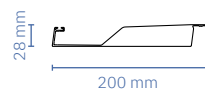

POLES

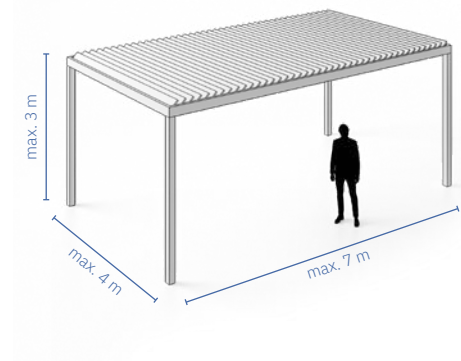
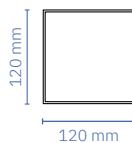

HIGH CORROSION RESISTANCE

Frame and all standard mechanical parts are made exclusively of aluminium and stainless steel.

PERGOLA FUNCTIONALITY LOAD (kg/m²)

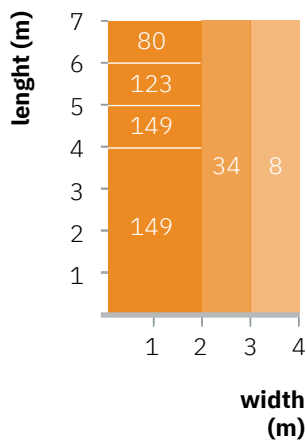

For pergola length over 6 m we suggest additional post or inclination on length for 3 cm.

BLADE PERFORMANCE

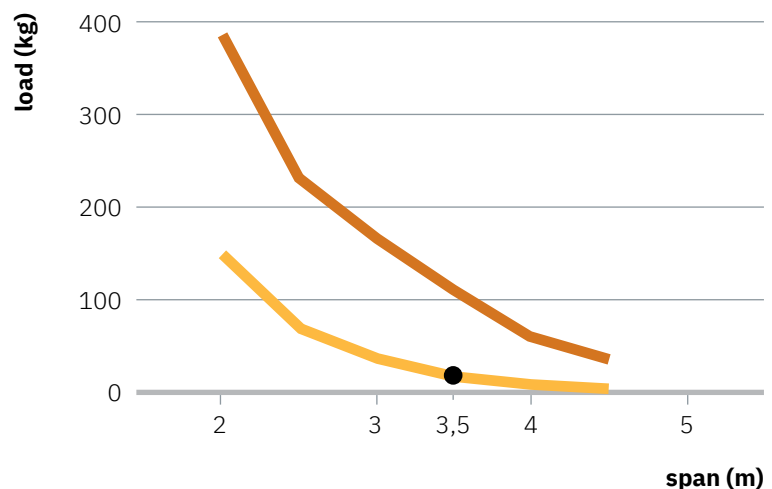

— SL28 blade / capacity

— SL28 blade / functional

● recommended maximal width in most countries

Price list

Soltec Bioclimatic Pergola

SL 170/36

Pergola high up to 3 m

ZIP roller blind [mm]	1260	1760	2260	2760	3260	3760	4260	4500
€/unit	1.501 €	1.654 €	1.754 €	1.906 €	2.006 €	2.158 €	2.284 €	2.357 €

Pergola high up to 3 m

ZIP roller blind [mm]	€/unit
819	1.407 €
1002	1.450 €
1184	1.501 €
1367	1.550 €
1549	1.601 €
1732	1.654 €
1915	1.703 €
2097	1.732 €
2280	1.754 €
2462	1.805 €
2645	1.855 €
2828	1.906 €
3010	1.956 €
3193	2.006 €
3375	2.058 €
3558	2.110 €
3741	2.158 €
3923	2.209 €
4106	2.245 €
4288	2.270 €
4471	2.319 €
4654	2.372 €
4836	2.423 €
5019	2.474 €
5201	2.521 €
5384	2.561 €
5567	2.608 €
5749	2.654 €

Pergola length [mm] Pergola width [mm] Blades

	1500	2000	2500	3000	3500	4000	4500	
1059	6.678 €	6.893 €	7.175 €	7.379 €	7.633 €	8.131 €	8.862 €	5
1242	6.858 €	7.092 €	7.411 €	7.633 €	7.941 €	8.428 €	9.088 €	6
1424	7.039 €	7.291 €	7.645 €	7.888 €	8.257 €	8.768 €	9.458 €	7
1607	7.222 €	7.491 €	7.876 €	8.147 €	8.374 €	8.954 €	9.681 €	8
1789	7.396 €	7.697 €	8.112 €	8.407 €	8.701 €	9.264 €	9.907 €	9
1972	7.554 €	7.894 €	8.349 €	8.671 €	9.031 €	9.583 €	10.321 €	10
2155	7.740 €	8.096 €	8.583 €	8.929 €	9.355 €	9.901 €	10.596 €	11
2337	7.915 €	8.291 €	8.828 €	9.188 €	9.675 €	10.225 €	10.850 €	12
2520	8.106 €	8.488 €	9.068 €	9.453 €	10.005 €	10.575 €	11.157 €	13
2702	8.279 €	8.690 €	9.310 €	9.717 €	10.336 €	10.914 €	11.586 €	14
2885	8.450 €	8.892 €	9.553 €	9.976 €	10.802 €	11.443 €	12.054 €	15
3068	8.603 €	9.088 €	9.789 €	10.269 €	11.139 €	11.805 €	12.425 €	16
3250	8.780 €	9.288 €	10.030 €	10.538 €	11.446 €	12.141 €	12.767 €	17
3433	8.832 €	9.486 €	10.270 €	10.758 €	11.744 €	12.425 €	13.094 €	18
3615	9.006 €	9.685 €	10.512 €	10.930 €	11.825 €	12.509 €	13.494 €	19
3798	9.341 €	10.073 €	10.955 €	11.539 €	12.415 €	13.100 €	13.824 €	20
3981	9.448 €	10.162 €	11.184 €	11.816 €	12.733 €	13.327 €	14.131 €	21
4163	9.534 €	10.243 €	11.376 €	12.004 €	13.009 €	13.896 €	14.707 €	22
4346	9.651 €	10.363 €	11.521 €	12.174 €	13.272 €	14.389 €	15.022 €	23
4528	9.806 €	10.525 €	11.668 €	12.365 €	13.534 €	14.659 €	15.327 €	24
4711	10.010 €	10.724 €	11.932 €	12.640 €	13.847 €	14.902 €	15.678 €	25
4894	10.205 €	10.926 €	12.174 €	12.887 €	14.088 €	15.136 €	15.956 €	26
5076	10.362 €	11.297 €	12.531 €	13.355 €	14.481 €	15.469 €	16.482 €	27
5259	10.457 €	11.434 €	12.709 €	13.693 €	14.819 €	15.840 €	16.630 €	28
5441	10.728 €	11.706 €	12.921 €	13.895 €	15.109 €	15.878 €	16.869 €	29
5624	10.899 €	11.863 €	13.126 €	14.074 €	15.364 €	16.185 €	16.983 €	30
5807	11.099 €	11.995 €	13.358 €	14.265 €	15.634 €	16.300 €	17.188 €	31
5989	11.270 €	12.127 €	13.590 €	14.455 €	15.919 €	16.351 €	17.561 €	32
6172	12.668 €	13.561 €	14.949 €	15.794 €	17.302 €	17.949 €	19.644 €	33
6354	12.816 €	13.701 €	15.099 €	16.155 €	17.528 €	18.277 €	20.068 €	34
6537	13.007 €	13.883 €	15.304 €	16.320 €	17.665 €	18.611 €	20.579 €	35
6720	13.170 €	14.073 €	15.456 €	16.521 €	17.867 €	19.041 €	21.201 €	36
6902	13.332 €	14.238 €	15.616 €	16.688 €	18.062 €	19.660 €	22.034 €	37



OBLIGATORY

Pergola inclination on length toward water exit:

15 mm, or use additional post.



Pergola inclination on width toward water exit:

0 mm	0 mm	5 mm	10 mm	15 mm	20 mm	25 mm
------	------	------	-------	-------	-------	-------

OBLIGATORY Blade inclined in frame for 7 mm.

INCLUDED IN PRICE: Structure and blades in standard RAL or bicolor, motor, control unit, remote control Teleco, standard mounting, wiring, power supply TRAFQ 220 AC / 24 DC. Prices are defined and expressed in EUR. The prices are always before VAT. Any discounts shall be agreed upon in written form. The prices are ex-works Soltec headquarters. Packaging excluded.

Technical details

Soltec Bioclimatic Pergola

SL 170/36

Blades	200/36
Profile	170/120
Poles	120/120
Max dimension 1 module	4.5 x 7 m
Installation - 4 poles	Self standing
Installation - up to 3 poles	Wall mounting
Foot type	Internal / external
Water exit	Standard / option
N° of water exit	2
Motorisation	1 / 2 motors

PROFILE 17

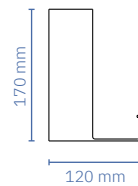

L BLADE

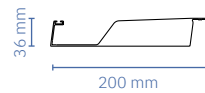

POLES

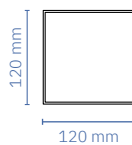

4.5x7m

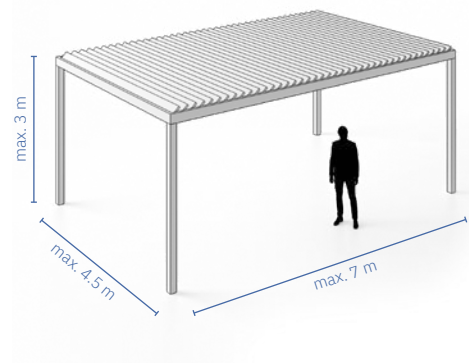

HIGH CORROSION RESISTANCE

Frame and all standard mechanical parts are made exclusively of aluminium and stainless steel.

PERGOLA FUNCTIONALITY LOAD (kg/m²)

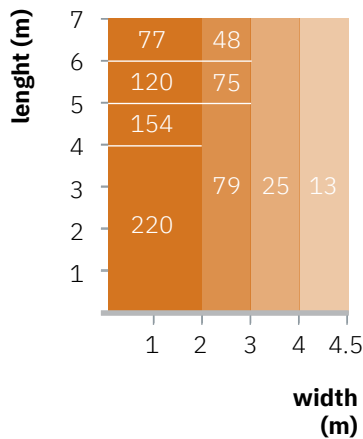

BLADE PERFORMANCE

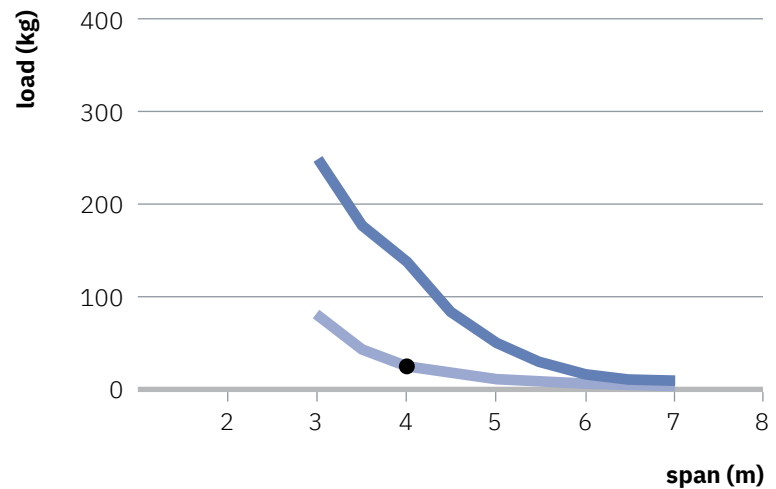

— SL36 blade / capacity

— SL36 blade / functional

● recommended maximal width in most countries

For pergola length over 6 m we suggest additional post or inclination on length for 3 cm.

Price list

Soltec **Bioclimatic Pergola**

SL 240/36

Pergola high up to 3 m

ZIP roller blind [mm]	1200	1700	2200	2700	3200	3700	4200	4700
€/unit	1.501 €	1.654 €	1.754 €	1.906 €	2.006 €	2.158 €	2.284 €	2.373 €

Pergola high up to 3 m

ZIP roller blind [mm]	€/unit
822	1.407 €
1005	1.450 €
1187	1.501 €
1370	1.550 €
1552	1.601 €
1735	1.654 €
1917	1.703 €
2100	1.732 €
2282	1.754 €
2465	1.805 €
2647	1.855 €
2830	1.906 €
3012	1.956 €
3195	2.006 €
3377	2.058 €
3560	2.110 €
3742	2.158 €
3925	2.209 €
4107	2.245 €
4290	2.270 €
4472	2.319 €
4655	2.372 €
4837	2.423 €
5020	2.474 €
5202	2.521 €
5385	2.561 €
5567	2.608 €
5750	2.654 €
5932	2.699 €
6115	2.747 €
6297	2.792 €
6480	2.839 €
6662	2.884 €

Pergola length [mm]

	Pergola width [mm]								Blades
	1500	2000	2500	3000	3500	4000	4500		
1122	9.344 €	9.711 €	10.079 €	10.446 €	10.815 €	11.182 €	11.550 €	5	
1305	9.529 €	9.931 €	10.332 €	10.734 €	11.135 €	11.536 €	11.938 €	6	
1487	9.715 €	10.150 €	10.586 €	11.020 €	11.455 €	11.890 €	12.325 €	7	
1670	9.901 €	10.370 €	10.838 €	11.307 €	11.776 €	12.244 €	12.713 €	8	
1852	10.087 €	10.589 €	11.091 €	11.594 €	12.096 €	12.599 €	13.101 €	9	
2035	10.273 €	10.809 €	11.345 €	11.880 €	12.417 €	12.953 €	13.489 €	10	
2217	10.459 €	11.028 €	11.598 €	12.168 €	12.737 €	13.306 €	13.876 €	11	
2400	10.645 €	11.249 €	11.851 €	12.455 €	13.058 €	13.660 €	14.264 €	12	
2582	10.831 €	11.468 €	12.104 €	12.741 €	13.377 €	14.015 €	14.652 €	13	
2765	11.018 €	11.687 €	12.358 €	13.029 €	13.698 €	14.369 €	15.040 €	14	
2947	11.203 €	11.906 €	12.611 €	13.315 €	14.019 €	14.723 €	15.427 €	15	
3130	11.389 €	12.127 €	12.864 €	13.602 €	14.340 €	15.077 €	15.815 €	16	
3312	11.575 €	12.346 €	13.117 €	13.888 €	14.659 €	15.430 €	16.203 €	17	
3495	11.761 €	12.566 €	13.371 €	14.176 €	14.980 €	15.785 €	16.590 €	18	
3677	11.946 €	12.786 €	13.624 €	14.462 €	15.301 €	16.139 €	16.977 €	19	
3860	12.133 €	13.005 €	13.877 €	14.749 €	15.622 €	16.493 €	17.366 €	20	
4042	12.338 €	13.246 €	14.154 €	15.061 €	15.970 €	16.879 €	17.786 €	21	
4225	12.524 €	13.466 €	14.407 €	15.348 €	16.291 €	17.233 €	18.174 €	22	
4407	12.710 €	13.685 €	14.660 €	15.636 €	16.612 €	17.586 €	18.561 €	23	
4590	12.915 €	13.926 €	14.937 €	15.948 €	16.961 €	17.972 €	18.983 €	24	
4772	13.101 €	14.145 €	15.190 €	16.235 €	17.282 €	18.326 €	19.370 €	25	
4955	13.288 €	14.366 €	15.443 €	16.521 €	17.602 €	18.680 €	19.758 €	26	
5137	13.473 €	14.585 €	15.696 €	16.809 €	17.922 €	19.034 €	20.146 €	27	
5320	13.659 €	14.805 €	15.950 €	17.096 €	18.243 €	19.389 €	20.533 €	28	
5502	13.864 €	15.046 €	16.226 €	17.408 €	18.593 €	19.773 €	20.955 €	29	
5685	14.050 €	15.265 €	16.480 €	17.695 €	18.913 €	20.127 €	21.342 €	30	
5867	14.236 €	15.484 €	16.733 €	17.981 €	19.233 €	20.482 €	21.730 €	31	
6050	15.651 €	16.933 €	18.215 €	19.497 €	20.782 €	22.064 €	23.346 €	32	
6232	15.837 €	17.152 €	18.467 €	19.783 €	21.103 €	22.418 €	23.733 €	33	
6415	16.022 €	17.372 €	18.721 €	20.070 €	21.423 €	22.772 €	24.121 €	34	
6597	16.228 €	17.613 €	18.998 €	20.382 €	21.772 €	23.158 €	24.542 €	35	
6780	16.414 €	17.832 €	19.251 €	20.670 €	22.093 €	23.512 €	24.930 €	36	
6962	16.600 €	18.052 €	19.504 €	20.957 €	22.414 €	23.865 €	25.318 €	37	
7145	16.786 €	18.272 €	19.758 €	21.243 €	22.733 €	24.219 €	25.706 €	38	
7327	16.972 €	18.491 €	20.011 €	21.530 €	23.054 €	24.574 €	26.093 €	39	
7510	17.157 €	18.711 €	20.265 €	21.818 €	23.375 €	24.928 €	26.481 €	40	
7692	17.344 €	18.931 €	20.517 €	22.104 €	23.695 €	25.282 €	26.869 €	41	
7875	17.530 €	19.150 €	20.770 €	22.391 €	24.015 €	25.636 €	27.256 €	42	
8057	17.716 €	19.369 €	21.024 €	22.677 €	24.336 €	25.990 €	27.644 €	43	



Pergola inclination on width toward water exit:

0 mm

0 mm

5 mm

10 mm

15 mm

20 mm

25 mm

OBLIGATORY Blade inclined in frame for 9 mm.

INCLUDED IN PRICE: Structure and blades in standard RAL or bicolor, motor, control unit, remote control Teleco, standard mounting, wiring, power supply TRAFQ 220 AC / 24 DC. Prices are defined and expressed in EUR. The prices are always before VAT. Any discounts shall be agreed upon in written form. The prices are ex-works Soltec headquarters. Packaging excluded.

Technical details

Soltec Bioclimatic Pergola

SL 240/36

Blades	200/36
Profile	240/150
Poles	150/150
Max dimension 1 module	4.5 x 8 m
Installation - 4 poles	Self standing
Installation - up to 3 poles	Wall mounting
Foot type	External*
Water exit	Standard / option
N° of water exit	2 / 3
Motorisation	1 motor / 2 motors

* subject to additional payment

PROFILE 24

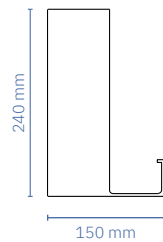

L BLADE

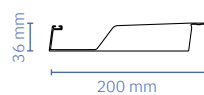

POLES

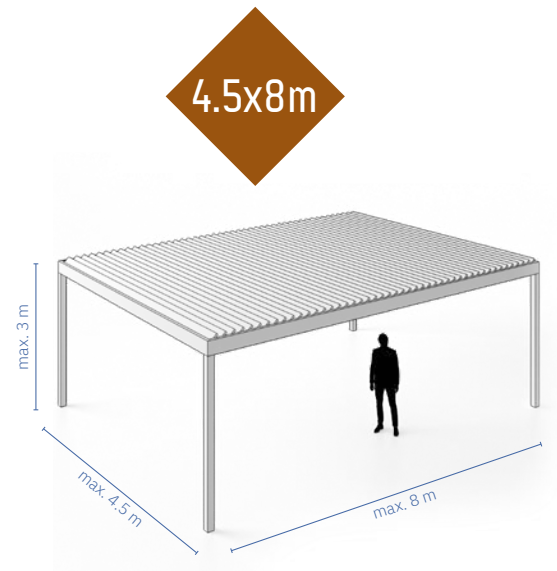
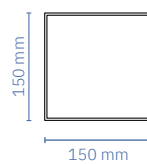

160/28 170/28 170/36 240/36 240/60 Cabrio 240/60

HIGH CORROSION RESISTANCE

Frame and all standard mechanical parts are made exclusively of aluminium and stainless steel.

PERGOLA FUNCTIONALITY LOAD (kg/m²)

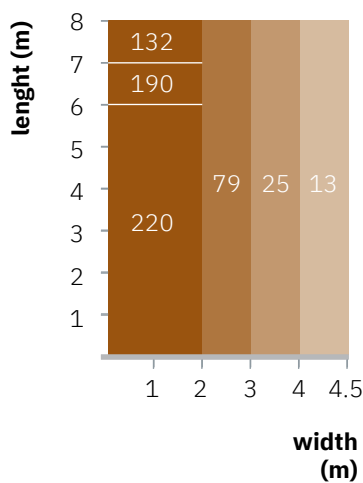

BLADE PERFORMANCE

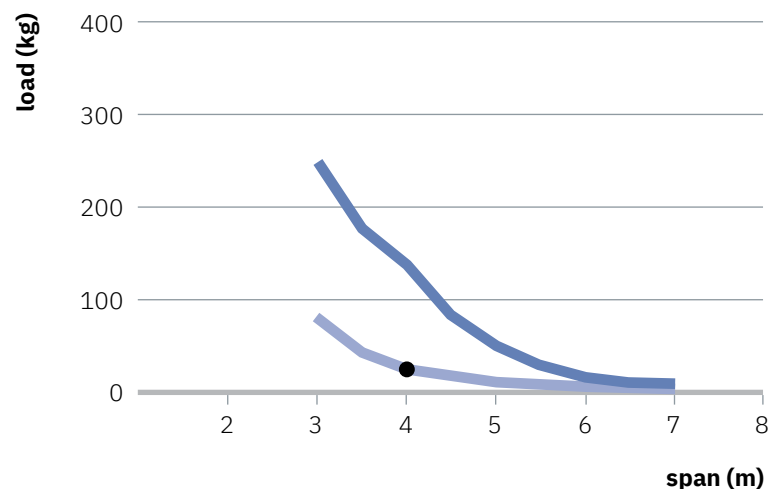

— SL36 blade / capacity

— SL36 blade / functional

● recommended maximal width in most countries

Price list

Soltec Bioclimatic Pergola

SL 240/60

Pergola high up to 3 m											
ZIP roller blind [mm]	1200	1700	2200	2700	3200	3700	4200	4700	5200	5700	6000
€/unit	1.502 €	1.626 €	1.721 €	1.837 €	2.010 €	2.159 €	2.271 €	2.373 €	2.523 €	2.651 €	2.729 €

Pergola high up to 3 m		Pergola length [mm]	Pergola width [mm]										Blades
ZIP roller blind [mm]	€/unit		1500	2000	2500	3000	3500	4000	4500	5000	5500	6000	
1176	1.502 €	1476	10.334 €	10.920 €	11.507 €	12.094 €	12.681 €	13.267 €	13.854 €	14.441 €	15.028 €	15.614 €	5
1429	1.601 €	1729	10.717 €	11.382 €	12.046 €	12.710 €	13.374 €	14.038 €	14.703 €	15.367 €	16.031 €	16.695 €	6
1682	1.575 €	1982	11.102 €	11.843 €	12.585 €	13.327 €	14.068 €	14.809 €	15.551 €	16.292 €	17.034 €	17.775 €	7
1935	1.647 €	2235	11.485 €	12.305 €	13.124 €	13.942 €	14.762 €	15.581 €	16.399 €	17.218 €	18.038 €	18.856 €	8
2188	1.721 €	2488	11.870 €	12.766 €	13.662 €	14.559 €	15.455 €	16.352 €	17.248 €	18.144 €	19.041 €	19.936 €	9
2441	1.738 €	2741	12.254 €	13.227 €	14.201 €	15.175 €	16.149 €	17.123 €	18.096 €	19.070 €	20.043 €	21.017 €	10
2694	1.837 €	2994	12.638 €	13.688 €	14.740 €	15.791 €	16.842 €	17.893 €	18.945 €	19.996 €	21.046 €	22.098 €	11
2947	1.895 €	3247	13.022 €	14.151 €	15.279 €	16.407 €	17.535 €	18.664 €	19.793 €	20.921 €	22.050 €	23.178 €	12
3200	2.010 €	3500	13.405 €	14.612 €	15.817 €	17.023 €	18.230 €	19.435 €	20.641 €	21.848 €	23.053 €	24.259 €	13
3453	2.061 €	3753	13.790 €	15.073 €	16.356 €	17.640 €	18.923 €	20.206 €	21.489 €	22.773 €	24.056 €	25.339 €	14
3706	2.159 €	4006	14.182 €	15.545 €	16.907 €	18.270 €	19.634 €	20.997 €	22.360 €	23.723 €	25.086 €	26.449 €	15
3959	2.211 €	4259	14.565 €	16.006 €	17.446 €	18.886 €	20.328 €	21.768 €	23.209 €	24.649 €	26.089 €	27.530 €	16
4212	2.271 €	4512	14.957 €	16.477 €	17.998 €	19.517 €	21.039 €	22.560 €	24.079 €	25.599 €	27.118 €	28.639 €	17
4465	2.304 €	4765	15.342 €	16.938 €	18.535 €	20.133 €	21.733 €	23.330 €	24.927 €	26.524 €	28.122 €	29.719 €	18
4718	2.373 €	5018	15.725 €	17.400 €	19.074 €	20.749 €	22.427 €	24.101 €	25.776 €	27.451 €	29.125 €	30.800 €	19
4971	2.423 €	5271	16.110 €	17.862 €	19.613 €	21.366 €	23.120 €	24.872 €	26.625 €	28.376 €	30.128 €	31.880 €	20
5224	2.523 €	5524	16.501 €	18.332 €	20.164 €	21.996 €	23.832 €	25.663 €	27.494 €	29.326 €	31.157 €	32.989 €	21
5477	2.562 €	5777	16.885 €	18.795 €	20.703 €	22.612 €	24.525 €	26.433 €	28.343 €	30.252 €	32.161 €	34.070 €	22
5730	2.651 €	6030	18.498 €	20.484 €	22.471 €	24.457 €	26.446 €	28.434 €	30.420 €	32.406 €	34.393 €	36.379 €	23
		6283	18.881 €	20.945 €	23.009 €	25.073 €	27.141 €	29.205 €	31.269 €	33.331 €	35.395 €	37.459 €	24
		6536	19.273 €	21.417 €	23.561 €	25.703 €	27.852 €	29.995 €	32.138 €	34.282 €	36.426 €	38.568 €	25
		6789	19.658 €	21.878 €	24.099 €	26.320 €	28.545 €	30.766 €	32.987 €	35.207 €	37.429 €	39.649 €	26
		7042	20.041 €	22.339 €	24.637 €	26.936 €	29.239 €	31.538 €	33.836 €	36.134 €	38.431 €	40.729 €	27
		7295	20.425 €	22.801 €	25.176 €	27.552 €	29.933 €	32.308 €	34.684 €	37.060 €	39.435 €	41.811 €	28
		7548	20.810 €	23.263 €	25.715 €	28.168 €	30.626 €	33.079 €	35.532 €	37.985 €	40.438 €	42.892 €	29
		7801	21.193 €	23.724 €	26.254 €	28.785 €	31.319 €	33.850 €	36.380 €	38.911 €	41.441 €	43.972 €	30
		8054	21.578 €	24.185 €	26.793 €	29.401 €	32.014 €	34.621 €	37.229 €	39.836 €	42.444 €	45.053 €	31



Pergola inclination on width toward water exit:

0 mm	0 mm	0 mm	0 mm	0 mm	0 mm	0 mm	5 mm	5 mm	10 mm	20 mm
------	------	------	------	------	------	------	------	------	-------	-------

OBLIGATORY Blade inclined in frame for 9 mm.

INCLUDED IN PRICE: Structure and blades in standard RAL or bicolor, motor, control unit, remote control Teleco, standard mounting, wiring, power supply TRAF0 220 AC / 24 DC. Prices are defined and expressed in EUR. The prices are always before VAT. Any discounts shall be agreed upon in written form. The prices are ex-works Soltec headquarters. Packaging excluded.

Technical details

Soltec Bioclimatic Pergola

SL 240/60

Blades	270/60
Profile	240/150
Poles	150/150
Max dimension 1 module	6 x 6 m, 5 x 8 m, max. 40 m ²
Installation - 4 poles	Self standing
Installation - up to 3 poles	Wall mounting
Foot type	External*
Water exit	Standard / option
N° of water exit	2 / 3
Motorisation	1 motor / 2 motors

* subject to additional payment

PROFILE 24

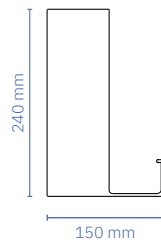

XL BLADE

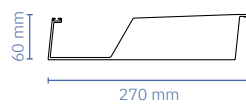

POLES

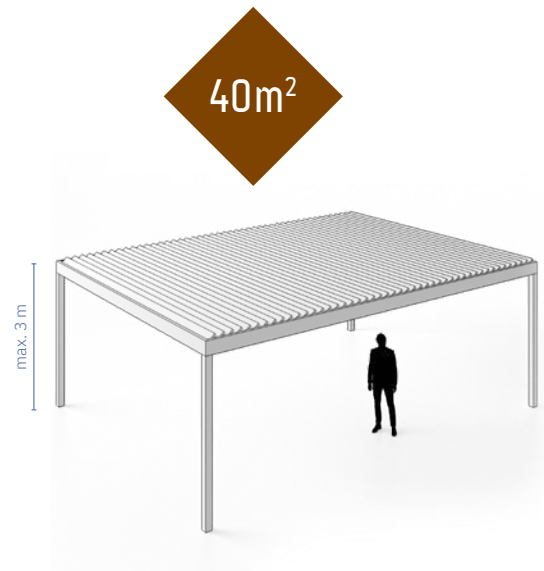
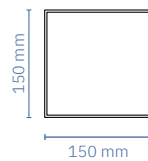

! The maximum dimensions are limited to the dimensions specified in the price list.

HIGH CORROSION RESISTANCE

Frame and all standard mechanical parts are made exclusively of aluminium and stainless steel.

PERGOLA FUNCTIONALITY LOAD (kg/m²)

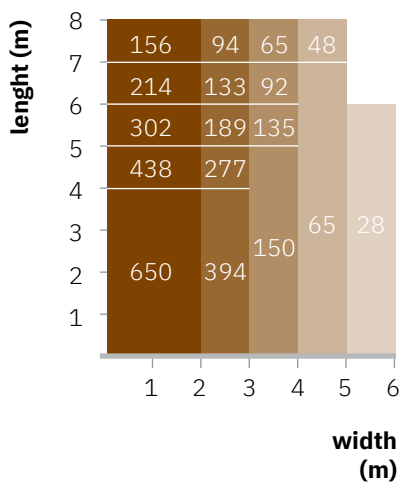

BLADE PERFORMANCE

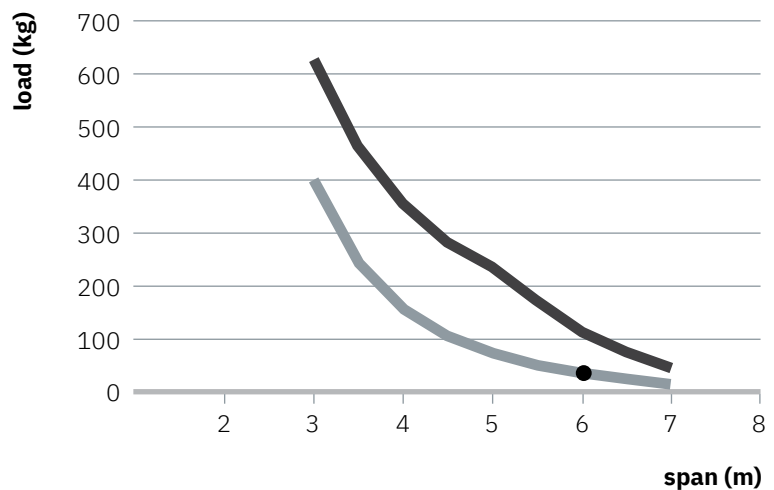

— XL60 blade / capacity

— XL60 blade / functional

● recommended maximal width in most countries

Price list

Soltec **Cabrio Bioclimatic Pergola**
RT 240/36

Pergola high up to 3 m

ZIP roller blind [mm]	1200	1700	2200	2700	3200	3700	4200
€/unit	1.501 €	1.654 €	1.754 €	1.906 €	2.006 €	2.158 €	2.284 €

Pergola high up to 3 m

ZIP roller blind [mm]	€/unit
822	1.407 €
1005	1.450 €
1187	1.501 €
1370	1.550 €
1552	1.601 €
1735	1.654 €
1917	1.703 €
2100	1.732 €
2282	1.754 €
2465	1.805 €
2647	1.855 €
2830	1.906 €
3012	1.956 €
3195	2.006 €
3377	2.058 €
3560	2.110 €
3742	2.158 €
3925	2.209 €
4107	2.245 €
4290	2.270 €
4472	2.319 €
4655	2.372 €
4837	2.423 €
5020	2.474 €
5202	2.521 €
5385	2.561 €
5567	2.608 €
5750	2.654 €
5932	2.699 €
6115	2.747 €
6297	2.792 €
6480	2.839 €
6662	2.884 €

Pergola length [mm]

	Pergola width [mm]						Blades
	1500	2000	2500	3000	3500	4000	
1577	13.232 €	13.722 €	14.212 €	14.702 €	15.192 €	15.682 €	5
1760	13.703 €	14.220 €	14.737 €	15.254 €	15.771 €	16.287 €	6
1942	14.174 €	14.718 €	15.262 €	15.805 €	16.349 €	16.893 €	7
2125	14.645 €	15.216 €	15.787 €	16.357 €	16.928 €	17.498 €	8
2307	15.116 €	15.714 €	16.311 €	16.909 €	17.507 €	18.104 €	9
2490	15.588 €	16.212 €	16.836 €	17.461 €	18.085 €	18.710 €	10
2672	16.059 €	16.710 €	17.361 €	18.013 €	18.664 €	19.315 €	11
2855	16.530 €	17.208 €	17.886 €	18.564 €	19.242 €	19.921 €	12
3037	17.001 €	17.706 €	18.411 €	19.116 €	19.821 €	20.526 €	13
3220	17.472 €	18.204 €	18.936 €	19.668 €	20.400 €	21.132 €	14
3402	17.943 €	18.702 €	19.461 €	20.220 €	20.978 €	21.737 €	15
3585	18.414 €	19.200 €	19.986 €	20.771 €	21.557 €	22.343 €	16
3767	18.886 €	19.698 €	20.511 €	21.323 €	22.136 €	22.948 €	17
3950	19.357 €	20.196 €	21.036 €	21.875 €	22.714 €	23.554 €	18
4132	19.828 €	20.694 €	21.560 €	22.427 €	23.293 €	24.159 €	19
4315	20.299 €	21.192 €	22.085 €	22.979 €	23.872 €	24.765 €	20
4497	20.770 €	21.690 €	22.610 €	23.530 €	24.450 €	25.370 €	21
4680	21.241 €	22.188 €	23.135 €	24.082 €	25.029 €	25.976 €	22
4862	21.712 €	22.686 €	23.660 €	24.634 €	25.608 €	26.582 €	23
5045	22.184 €	23.184 €	24.185 €	25.186 €	26.186 €	27.187 €	24
5227	22.655 €	23.682 €	24.710 €	25.737 €	26.765 €	27.793 €	25
5410	23.126 €	24.180 €	25.235 €	26.289 €	27.344 €	28.398 €	26
5592	23.597 €	24.678 €	25.760 €	26.841 €	27.922 €	29.004 €	27
5775	24.068 €	25.176 €	26.285 €	27.393 €	28.501 €	29.609 €	28
5957	24.539 €	25.674 €	26.809 €	27.945 €	29.080 €	30.215 €	29
6140	25.010 €	26.172 €	27.334 €	28.496 €	29.658 €	30.820 €	30
6322	25.482 €	26.670 €	27.859 €	29.048 €	30.237 €	31.426 €	31
6505	25.953 €	27.168 €	28.384 €	29.600 €	30.816 €	32.031 €	32
6687	26.424 €	27.666 €	28.909 €	30.152 €	31.394 €	32.637 €	33
6870	26.895 €	28.164 €	29.434 €	30.704 €	31.973 €	33.243 €	34
7052	27.366 €	28.663 €	29.959 €	31.255 €	32.552 €	33.848 €	35
7235	27.837 €	29.161 €	30.484 €	31.807 €	33.130 €	34.454 €	36
7417	28.308 €	29.659 €	31.009 €	32.359 €	33.709 €	35.059 €	37
7600	28.780 €	30.157 €	31.534 €	32.911 €	34.288 €	35.665 €	38
7782	29.251 €	30.655 €	32.058 €	33.462 €	34.866 €	36.270 €	39
7965	29.722 €	31.153 €	32.583 €	34.014 €	35.445 €	36.876 €	40
8147	30.193 €	31.651 €	33.108 €	34.566 €	36.024 €	37.481 €	41



Pergola inclination on width toward water exit:

0 mm

0 mm

5 mm

10 mm

15 mm

20 mm

25 mm

OBLIGATORY Blade inclined in frame for 9 mm.

INCLUDED IN PRICE: Structure and blades in standard RAL or bicolor, motor, control unit, remote control Teleco, standard mounting, wiring, power supply TRAF0 220 AC / 24 DC. Prices are defined and expressed in EUR. The prices are always before VAT. Any discounts shall be agreed upon in written form. The prices are ex-works Soltec headquarters. Packaging excluded.

Technical details

Soltec Cabrio Bioclimatic Pergola RT 240/36

Blades	200/36
Profile	240/150
Poles	150/150
Max dimension 1 module	4 x 8 m
Installation - 4 poles	Self standing
Installation - up to 3 poles	Wall mounting
Foot type	External*
Water exit	Standard / option
N° of water exit	2 / 3
Motorisation	3 motors

* subject to additional payment

PROFILE RT24

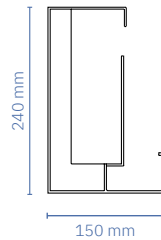

L BLADE

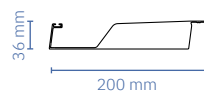

POLES

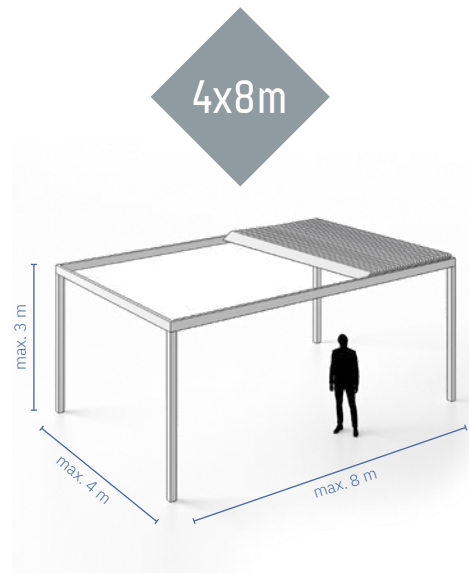
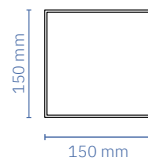

! The maximum dimensions are limited to the dimensions specified in the price list.

HIGH CORROSION RESISTANCE

Frame and all standard mechanical parts are made exclusively of aluminium and stainless steel.

PERGOLA FUNCTIONALITY LOAD (kg/m²)

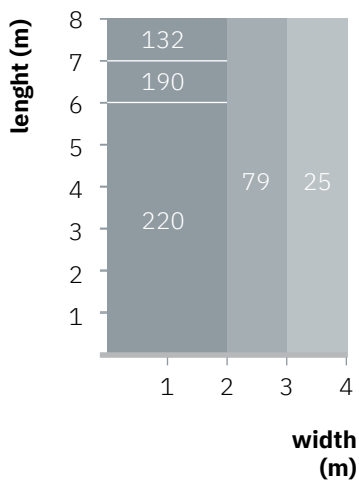

BLADE PERFORMANCE

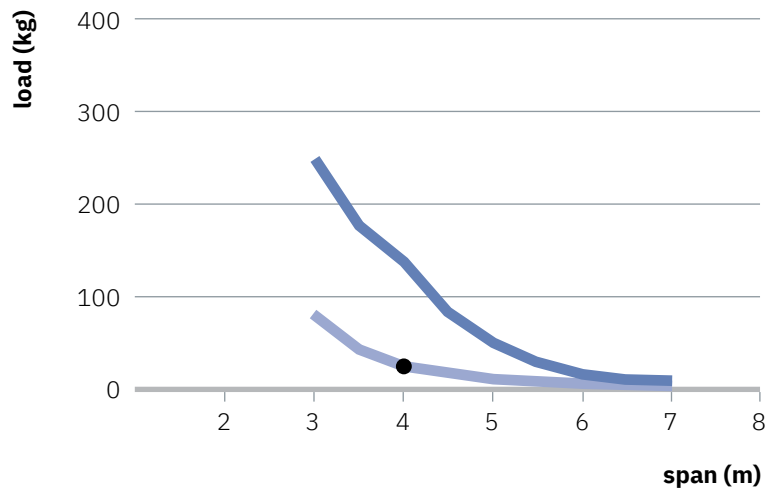

— SL36 blade / capacity

— SL36 blade / functional

● recommended maximal width in most countries

Price calculation simulation

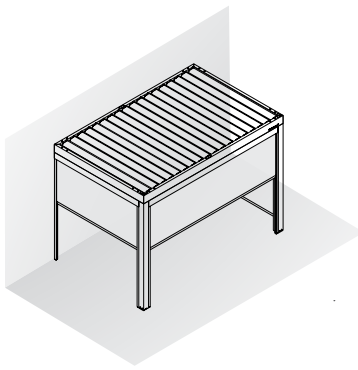

EXAMPLE

Bioclimatic Pergola SL 170/28 (2 poles, mounting on wall) + ZIP ROLLER BLINDS + LED lights

Customer would like to purchase Bioclimatic Pergola SL 170/28 - 2500 mm width and 5076 mm length, on 2 poles, standard mounting on concrete wall, add ZIP roller blinds and LED lights.

Pergola high up to 3 m		Pergola high up to 3 m						
ZIP roller blind [mm]	€ /unit	1260	1760	2260	2760	3260	3260	>3760
		1.501 €	1.654 €	1.754 €	2.006 €	2.158 €	2.328 €	

Pergola high up to 3 m		Pergola length [mm]							Blades
ZIP roller blind [mm]	€ /unit	1500	2000	2500	3000	3500	4000		
1002	1.450 €	5.832 €	6.028 €	6.301 €	6.487 €	6.750 €	7.164 €	6	
1184	1.501 €	5.984 €	6.199 €	6.499 €	6.705 €	7.017 €	7.455 €	7	
1367	1.550 €	6.140 €	6.369 €	6.696 €	6.925 €	7.118 €	7.611 €	8	
1549	1.601 €	6.288 €	6.542 €	6.895 €	7.147 €	7.396 €	7.874 €	9	
1732	1.654 €	6.420 €	6.711 €	7.097 €	7.370 €	7.676 €	8.147 €	10	
1915	1.703 €	6.578 €	6.882 €	7.297 €	7.591 €	7.953 €	8.416 €	11	
2097	1.732 €	6.729 €	7.048 €	7.505 €	7.810 €	8.224 €	8.692 €	12	
2280	1.754 €	6.892 €	7.215 €	7.708 €	8.035 €	8.504 €	8.989 €	13	
2462	1.805 €	7.036 €	7.388 €	7.815 €	8.259 €	8.786 €	9.277 €	14	
2645	1.855 €	7.183 €	7.558 €	8.020 €	8.482 €	9.182 €	9.727 €	15	
2828	1.906 €	7.311 €	7.726 €	8.222 €	8.729 €	9.469 €	10.035 €	16	
3010	1.956 €	7.461 €	7.894 €	8.527 €	8.957 €	9.730 €	10.321 €	17	
3193	2.006 €	7.507 €	8.063 €	8.730 €	9.146 €	9.982 €	10.563 €	18	
3375	2.058 €	7.654 €	8.232 €	8.934 €	9.291 €	10.052 €	10.632 €	19	
3558	2.110 €	7.940 €	8.563 €	9.312 €	9.810 €	10.552 €	11.135 €	20	
3741	2.158 €	8.030 €	8.638 €	9.507 €	10.044 €	10.823 €	11.328 €	21	
3923	2.209 €	8.105 €	8.707 €	9.671 €	10.204 €	11.059 €	11.812 €	22	
4106	2.245 €	8.204 €	8.810 €	9.793 €	10.349 €	11.282 €	12.231 €	23	
4288	2.270 €	8.334 €	8.948 €	9.918 €	10.511 €	11.502 €	12.462 €	24	
4471	2.319 €	8.510 €	9.116 €	10.143 €	10.743 €	11.770 €	12.668 €	25	
4654	2.372 €	8.676 €	9.286 €	10.349 €	10.955 €	11.977 €	12.865 €	26	
483	2.423 €	8.888 €	9.684 €	10.653 €	11.203 €	12.309 €	13.148 €	27	
5019	2.474 €	8.888 €	9.719 €	10.803 €	11.640 €	12.597 €	13.465 €	28	
5201	2.521 €	9.120 €	9.951 €	10.982 €	11.811 €	12.843 €	13.497 €	29	
5384	2.561 €	9.264 €	10.084 €	11.158 €	11.963 €	13.059 €	13.515 €	30	
5567	2.608 €	9.435 €	10.196 €	11.355 €	12.126 €	13.288 €	13.807 €	31	
5749	2.654 €	9.579 €	10.307 €	11.552 €	12.288 €	13.533 €	13.900 €	32	
		10.982 €	11.740 €	12.923 €	13.640 €	14.923 €	15.237 €	33	
		11.108 €	11.861 €	13.049 €	13.947 €	15.114 €	15.548 €	34	
		11.272 €	12.017 €	13.224 €	14.087 €	15.230 €	16.035 €	35	
		11.409 €	12.177 €	13.354 €	14.258 €	15.401 €	16.399 €	36	
		11.547 €	12.318 €	13.489 €	14.399 €	15.569 €	16.925 €	37	

CALCULATION IN 5 STEPS



Bioclimatic pergola, model 170/28

2500mm x 5076mm 10.653 €
- 2 poles (-184 € / pole) -368 €

Total 10.285 €



ZIP Roller on WIDTH SIDES

ZIP Roller P1-P3 1.754 €
ZIP Roller P2-P4 1.754 €

Total 3.508 €



Zip Roller on LENGTH SIDE

ZIP Roller P1-P2 2.423 €

Total 2.423 €



OPTIONS

4x LED Light 100cm 324€/unit

Total 1.296 €



Final price for the customer

17.512 €

INCLUDED IN BIOCLIMATIC PERGOLA SL PRICE

- Structure 4 poles included blades in standard RAL or bicolor
- Motor control unit
- Remote control
- Deduct two poles: (-187€/pole)
- Blades 200/28

BIOCLIMATIC PERGOLA SL OPTIONS

Subject to additional payment.

- Add non-standard color
- 3 LED light 1m integrated in blades
- External foot
- Painted external foot
- Wall mounting ADP
- Concav or convex cover
- Special water exit (SWE1 or SWE2)
- Heater+driver
- Rain sensor
- Wind sensor
- Sliding panels
- Glass panels

INCLUDED IN ZIP ROLLER PRICE

- Screen SERGE - glass fiber
- Standard RAL same as pergola
- Standard guides 34 x 45
- Cassette 120 x 130
- Motor

ZIP ROLLER OPTIONS

Subject to additional payment.

- Soltis 92 screen
- Crystal full screen
- Crystal window
- Somfy motor with receiver

Prices for additional items are calculated according to the current price list.

sensor

LED lights

sliding panels / glass panels

heater

sound system

ZIP roller blinds

Daisy
WiFi pergola controller

Outlet +
USB



Options

ZIP roller blinds

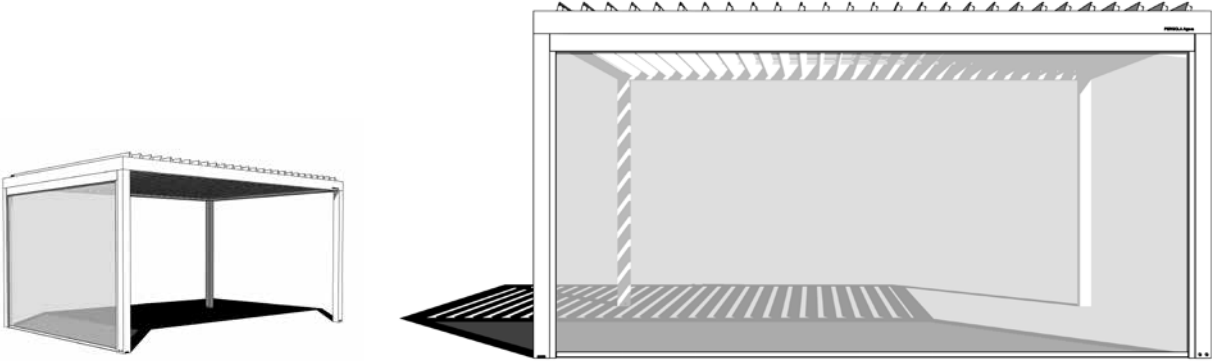

STANDARD

Front view

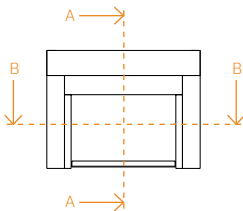

Section view A-A

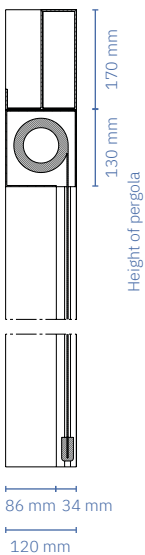

Section view B-B

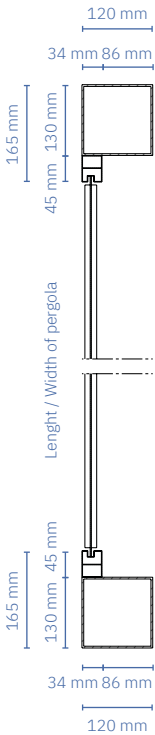

Options

Glass panels

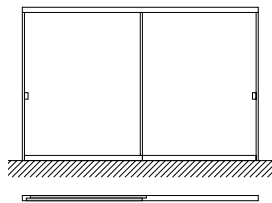
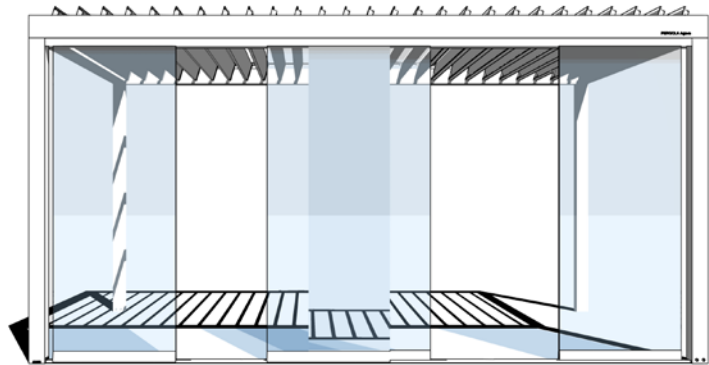
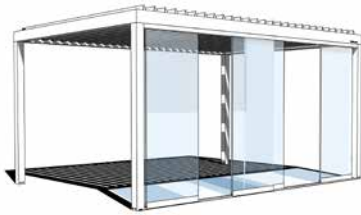

2 guides system

STANDARD

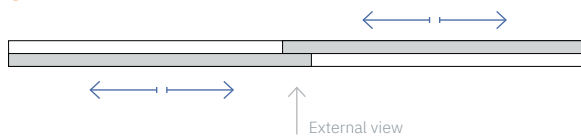

REVERSE

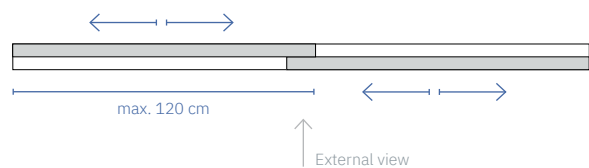

Height (cm)	Total length (cm)									
	160	180	200	220	240	260	280	300	320	
min. number of panels	2					3				
up to 200	2.478 €	2.569 €	2.659 €	2.748 €	2.840 €	2.929 €	3.018 €	3.108 €	3.196 €	
up to 250	2.625 €	2.736 €	2.845 €	2.958 €	3.069 €	3.179 €	3.291 €	3.401 €	3.512 €	
up to 300	2.949 €	3.085 €	3.217 €	3.350 €	3.460 €	3.592 €	3.724 €	3.856 €	3.987 €	

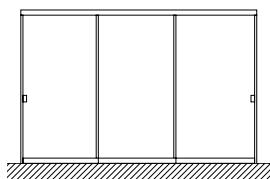

3 guides system

STANDARD

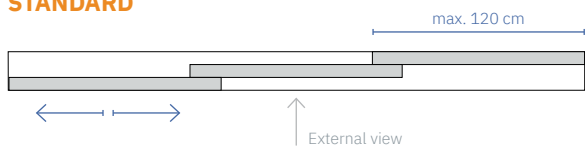

REVERSE



Height (cm)	Total length (cm)						
	220	240	260	280	300	320	340
min. number of panels	2		3			4	
up to 200	3.138 €	3.233 €	3.327 €	3.420 €	3.516 €	3.610 €	3.705 €
up to 250	3.280 €	3.396 €	3.513 €	3.631 €	3.746 €	3.863 €	3.981 €
up to 300	3.717 €	3.856 €	3.968 €	4.111 €	4.244 €	4.389 €	4.507 €
	360	380	400	420	440	460	480
min. number of panels	4						
up to 200	3.799 €	3.894 €	3.990 €	4.083 €	4.177 €	4.272 €	4.366 €
up to 250	4.097 €	4.214 €	4.329 €	4.447 €	4.565 €	4.679 €	4.797 €
up to 300	4.641 €	4.774 €	4.913 €	5.054 €	5.193 €	5.325 €	5.466 €

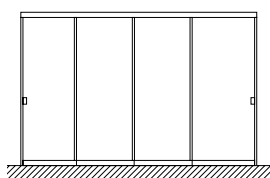

4 guides system

STANDARD

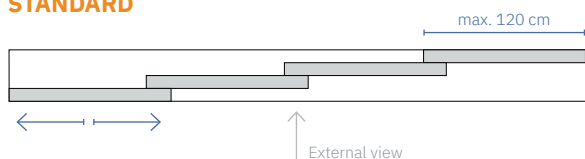

REVERSE

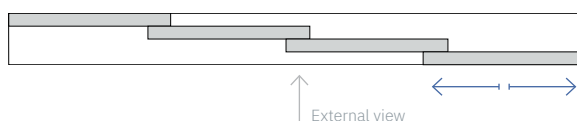

Height (cm)	Total length (cm)								
	280	300	320	340	360	380	400	420	
min. number of panels	3			4					
up to 200	3.898 €	3.994 €	4.095 €	4.193 €	4.290 €	4.390 €	4.487 €	4.585 €	
up to 250	4.082 €	4.201 €	4.320 €	4.441 €	4.565 €	4.684 €	4.804 €	4.923 €	
up to 300	4.621 €	4.759 €	4.909 €	5.027 €	5.169 €	5.308 €	5.452 €	5.596 €	
	440	460	480	500	520	540	560	580	600
min. number of panels	4			5					
up to 200	4.686 €	4.782 €	4.880 €	4.979 €	5.076 €	5.175 €	5.272 €	5.372 €	5.471 €
up to 250	5.043 €	5.164 €	5.286 €	5.405 €	5.525 €	5.645 €	5.764 €	5.885 €	6.006 €
up to 300	5.740 €	5.879 €	6.023 €	6.141 €	6.284 €	6.422 €	6.566 €	6.704 €	6.843 €

Options

Sliding panels

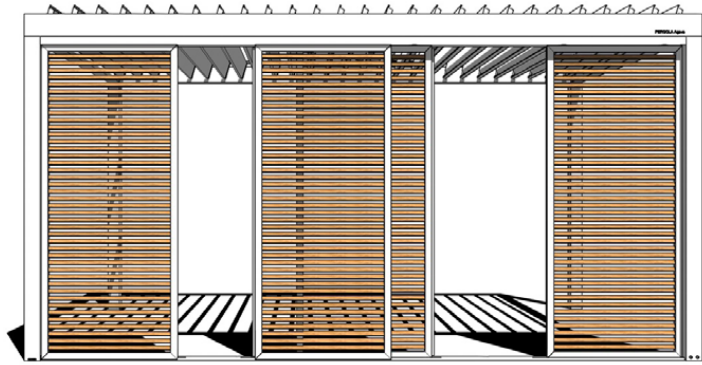

WOOD

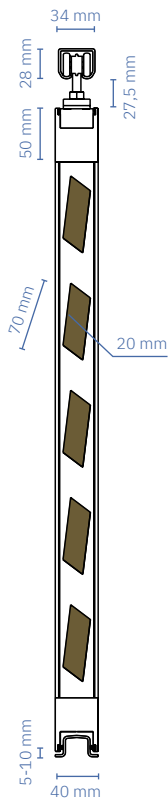

WOOD DOUBLE

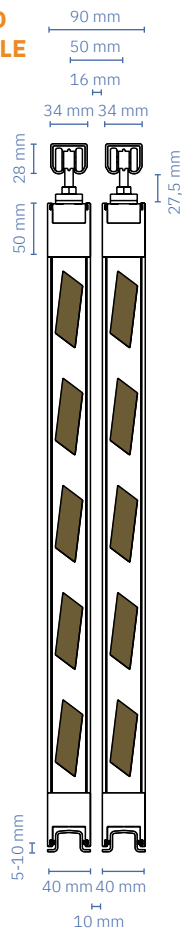

ALU

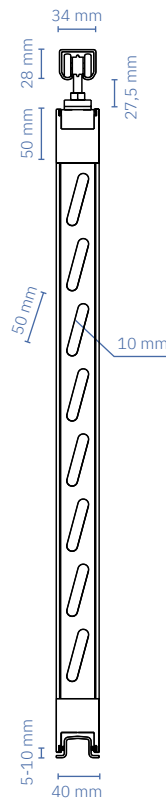

ALU DOUBLE

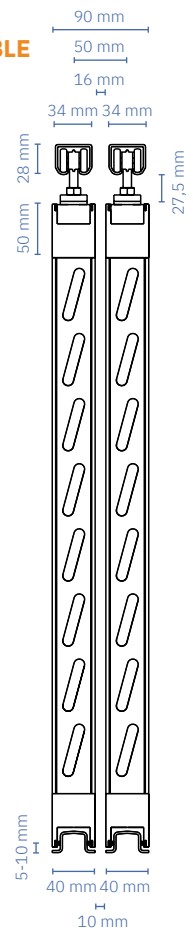

1 guide system



	Height (mm)	Width (mm)								
		400	500	600	700	800	900	1000	1100	1200
Wood slat 17/70 mm	up to 2000	641 €	684 €	727 €	772 €	810 €	855 €	898 €	941 €	983 €
Alu slat 10/50 mm		576 €	616 €	654 €	694 €	729 €	769 €	808 €	847 €	885 €
Wood slat 17/70 mm	up to 2200	680 €	719 €	778 €	816 €	869 €	889 €	948 €	1.000 €	1.041 €
Alu slat 10/50 mm		612 €	647 €	700 €	735 €	783 €	800 €	854 €	900 €	936 €
Wood slat 17/70 mm	up to 2500	706 €	754 €	804 €	853 €	900 €	950 €	998 €	1.047 €	1.097 €
Alu slat 10/50 mm		636 €	679 €	724 €	767 €	810 €	855 €	899 €	942 €	987 €
Wood slat 17/70 mm	up to 2700	746 €	789 €	855 €	897 €	960 €	984 €	1.048 €	1.106 €	1.154 €
Alu slat 10/50 mm		670 €	709 €	771 €	807 €	864 €	885 €	946 €	996 €	1.038 €
Wood slat 17/70 mm	up to 3000	771 €	825 €	881 €	934 €	991 €	1.046 €	1.099 €	1.153 €	1.210 €
Alu slat 10/50 mm		694 €	740 €	795 €	840 €	892 €	940 €	991 €	1.038 €	1.089 €

2 guides system



	Height (mm)	Width (mm)								
		400	500	600	700	800	900	1000	1100	1200
Wood slat 17/70 mm	up to 2000	719 €	781 €	844 €	909 €	967 €	1.031 €	1.093 €	1.156 €	1.218 €
Alu slat 10/50 mm		647 €	704 €	760 €	818 €	871 €	928 €	984 €	1.042 €	1.097 €
Wood slat 17/70 mm	up to 2200	759 €	817 €	896 €	953 €	1.026 €	1.065 €	1.143 €	1.215 €	1.276 €
Alu slat 10/50 mm		682 €	736 €	806 €	857 €	924 €	960 €	1.030 €	1.093 €	1.147 €
Wood slat 17/70 mm	up to 2500	902 €	952 €	1.002 €	1.049 €	1.098 €	1.147 €	1.196 €	1.245 €	1.294 €
Alu slat 10/50 mm		812 €	856 €	900 €	943 €	988 €	1.033 €	1.077 €	1.120 €	1.165 €
Wood slat 17/70 mm	up to 2700	941 €	987 €	1.051 €	1.093 €	1.157 €	1.181 €	1.245 €	1.303 €	1.352 €
Alu slat 10/50 mm		847 €	888 €	948 €	982 €	1.042 €	1.063 €	1.123 €	1.172 €	1.214 €
Wood slat 17/70 mm	up to 3000	1.085 €	1.122 €	1.158 €	1.191 €	1.228 €	1.263 €	1.298 €	1.332 €	1.370 €
Alu slat 10/50 mm		977 €	1.009 €	1.042 €	1.069 €	1.106 €	1.138 €	1.170 €	1.198 €	1.232 €



Options Roof

Special profile for glass

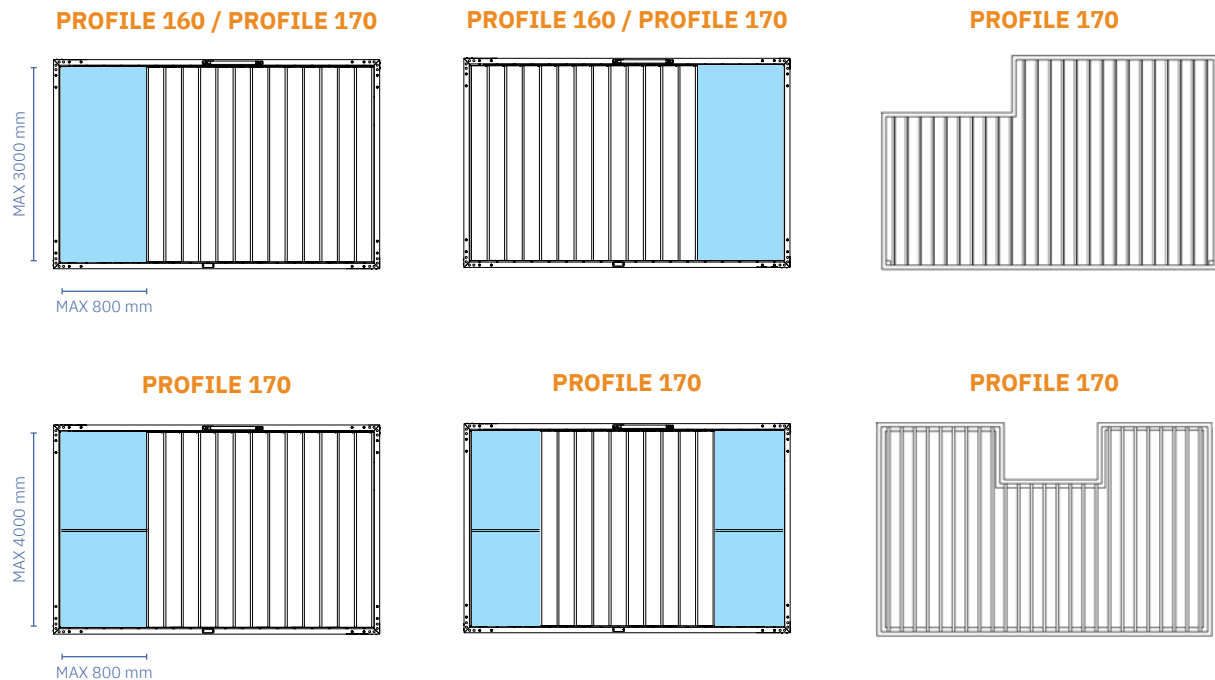

Subject to additional payment.

- Alu profile 50/100 - powder painted, 61 € / m¹
- Alu profile K7 - powder painted. L = 3m, 363 € / m¹
- Alu profile K7 - powder painted. L = 4,5 m, 526 € / m¹
- Glass 88.2, laminated + tempered glass (dimension up to 800 x 3000 mm), 435 € / m²
- Glass 66.2, laminated + tempered glass (dimension up to 500 x 3000 mm), 298 € / m²
- ALU sheets 1,5 mm - powder painted, 92 € / m²
- ALU sheets 2 mm - powder painted, 123 € / m²
- ALU sheets 3 mm - powder painted, 184 € / m²

Options

Roof types

TYPE A

Cover position depends on the blade opening way chosen in order form.

Subject to additional payment 40 € / m².
Covers must be installed by instaler, covers are not pre-drilled.



TYPE B

Gutter position depends on the blade opening way chosen in order form.

Subject to additional payment 40 € / m².
Covers must be installed by instaler, covers are not pre-drilled.

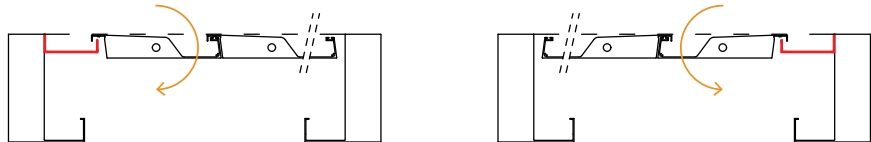

TYPE C

Glass roof integration

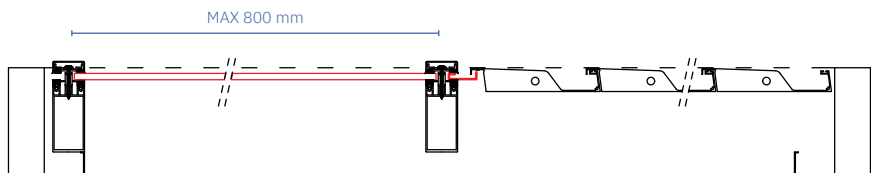

TYPE D

Aluminium sheet roof integration

Aluminium sheets can be delivered in maximal length of 3 m.

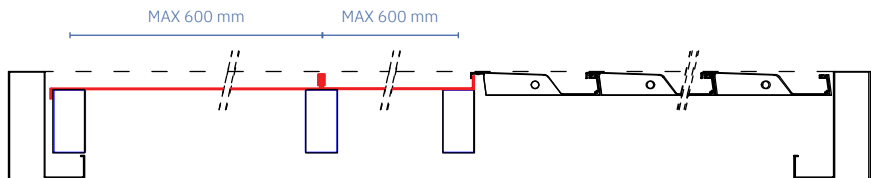

TYPE E

Aluminium sheet roof integration

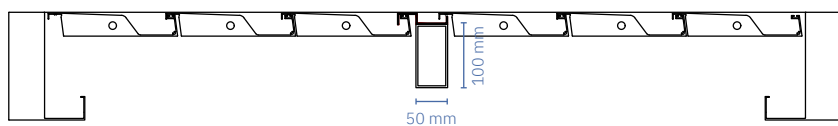

The sheet metal is riveted. Riveting is performed when assembling at the customer's location. Sheet metal is manufactured up to 3 m long. Larger dimensions are composed of several sheets.

Options

Special water evacuation

TYPE V

Vertical evacuation through rain gutter with ALU tube \varnothing 50 mm

Position of water location and type must be marked on drawing.

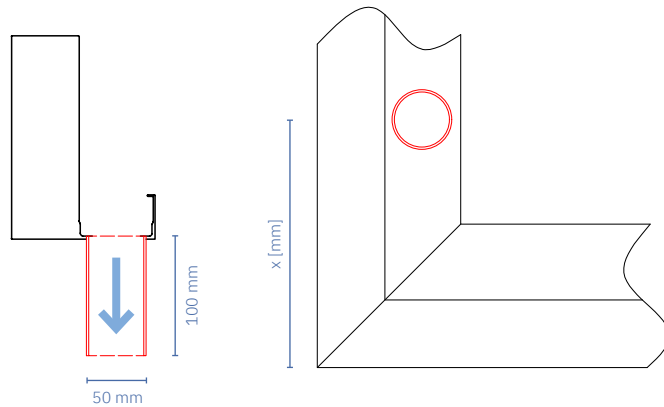

TYPE H

Horizontal evacuation through beam with ALU tube \varnothing 50 mm

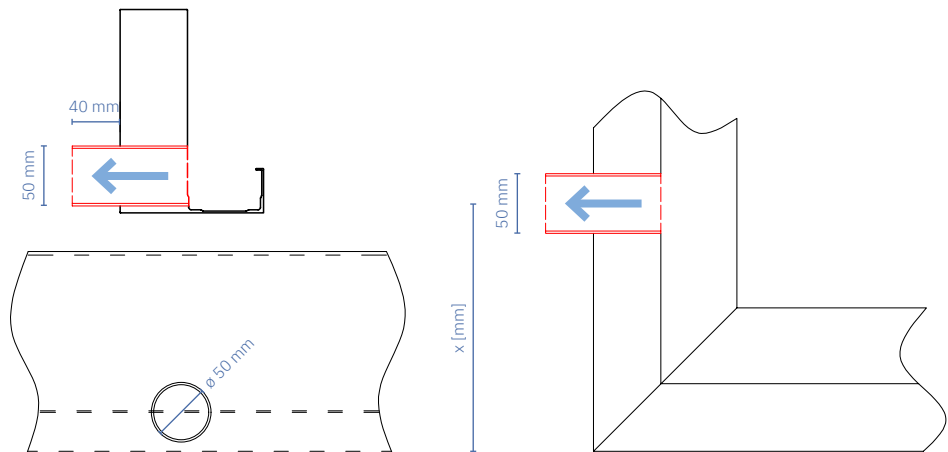

TYPE P

Horizontal evacuation through beam with PVC tube \varnothing 50 mm

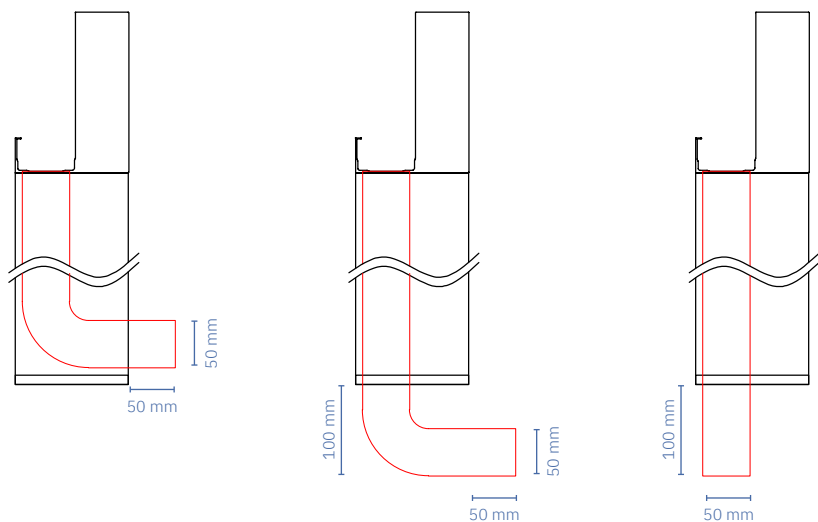

Subject to additional payment 170 € / pcs.
Water exit pipe is welded to the frame profile.

Options

Wall mounting

STANDARD

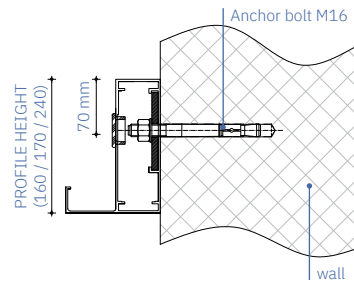

OPTIONAL 1

Subject to additional payment of 60 €/piece

Protection:

- galvanization

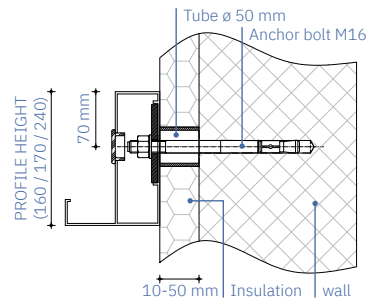

OPTIONAL 2

Subject to additional payment.

Protection:

- galvanization (130 €/piece),
- galvanization + painting (170 €/piece),
- stainless steel (320 €/piece)

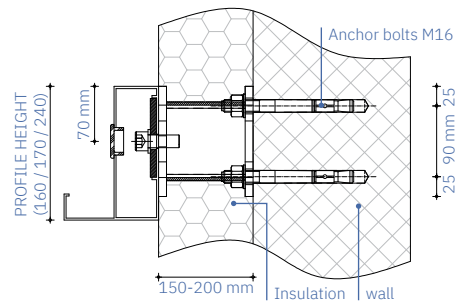

OPTIONAL 3

Subject to additional payment.

Protection:

- galvanization (130 €/piece),
- galvanization + painting (170 €/piece),
- stainless steel (320 €/piece)

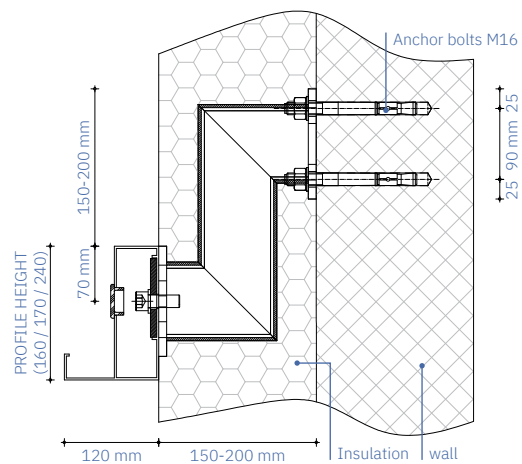

Options

Foot mounting

STANDARD / INTERNAL

Protection: inox.

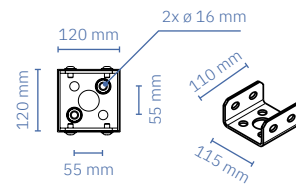
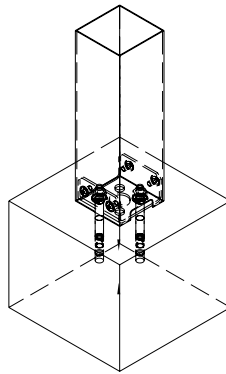

OPTIONAL / EXTERNAL

Protection:

- galvanization (130 €/piece),
- galvanization + painting (170 €/piece),
- stainless steel (320 €/piece)

Recommendation

We recommend using the Foot Mounting - EXTERNAL for all freestanding pergolas in conjunction with the stability function.

EXTERNAL 1

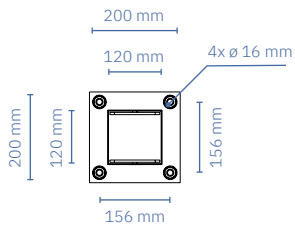
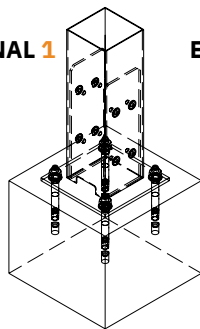

EXTERNAL 2

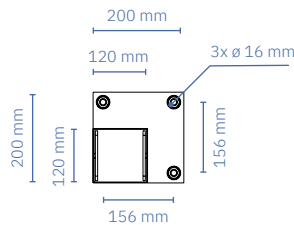
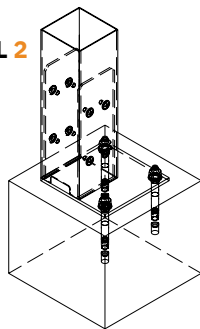

EXTERNAL 3

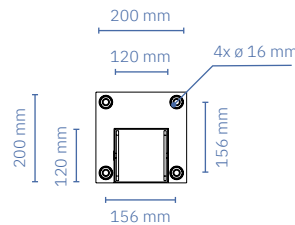
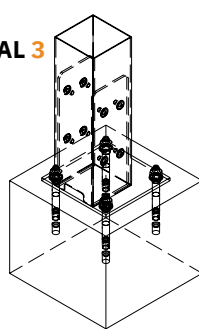

EXTERNAL 4

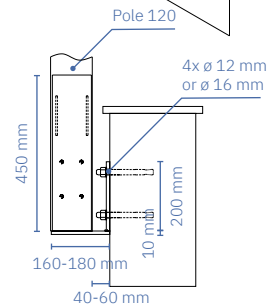
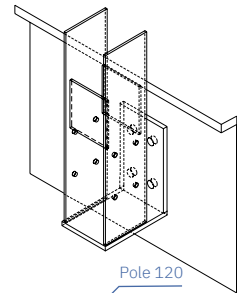

Poles 150/150 come only with external foot.

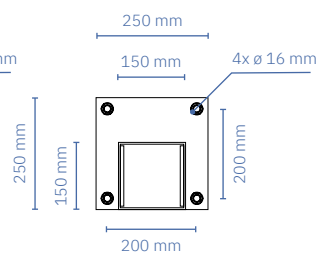
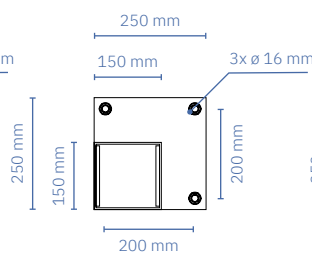
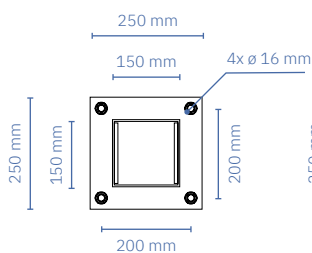

Accessories



Item	Unit	Price
Non-standard blade color	PCS	864 €
Non-standard structure color	PCS	756 €
AUDIO speaker / WHITE or BLACK	PCS	121 €
AUDIO speaker /WHITE or BLACK (for a set of 4)	PCS	296 €
AUDIO system melody Teleco + remote control Teleco	PCS	1.026 €
Daisy/WiFi Pergola Controller	PCS	672 €
External antenna Teleco	PCS	73 €
Concave / convex cover (per meter)	m	65 €
Special water evacuation (Type V, H, P)	PCS	184 €
Wall mounting (pcs)	PCS	65 €
LED lights strip in blade 0,5m / warm or neutral white + driver	PCS	216 €
LED lights strip in blade 0,5m / RGBW + driver	PCS	270 €
LED lights strip in blade 1 m / warm or neutral white + driver	PCS	324 €
LED lights strip in blade 1 m / RGBW + driver	PCS	378 €
LED lights strip in blade 1,5 m / warm or neutral white + driver	PCS	378 €
LED lights strip in blade 1,5m / RGBW + driver	PCS	432 €
Heater Burda IR Relax Glass / BLACK	PCS	1.843 €
Heater Burda IR Relax Glass / control unit + remote control / BLACK	PCS	2.048 €
Heater Burda IR Relax Glass / control unit + remote control / INOX	PCS	1.847 €
Heater Burda IR Relax Glass / INOX	PCS	1.642 €
Heater Burda Relax / control unit + remote control / DARK	PCS	1.437 €
Heater Burda Relax / DARK	PCS	1.232 €
Heater infra IPX5 1,5 kW / Heliosa + controler / WHITE or ANTHRACITE	PCS	594 €
Kit of small spare parts	KIT	98 €
Warm White/Neutral White/RGB Strip IP 65	m	98 €
Presence sensor BLACK	PCS	320 €
Presence sensor WHITE	PCS	194 €
Rain sensor Teleco	PCS	296 €
Recessed transmitter (programming and connection done by customer)	PCS	156 €
Remote control Somfy RTS Situo 5 + Teleco Bridge	PCS	370 €
Remote control Somfy RTS Telis 16 + Teleco Bridge	PCS	475 €
Remote control Somfy RTS Telis 1 + Teleco Bridge	PCS	247 €
Remote control Teleco	PCS	119 €
Snow sensor	PCS	370 €
Socket with protective cap ANTRACHITE	PCS	135 €
Somfy motor for screen ZIP 230/20 Nm - Altus 50 RTS receiver	PCS	492 €
Spot lights BETA / 8 pcs / warm white + driver KIT	PCS	1.404 €
Surface-mounted socket with protective cap GRAY	PCS	10 €
Surface-mounted socket with protective cap WHITE	PCS	10 €
Surface-mounted switch WHITE or GRAY	PCS	130 €
Switch 1-ch	PCS	126 €
Switch 2-ch	PCS	197 €
Teleco / Somfy Bridge 1	PCS	161 €
Teleco / Somfy Bridge 7	PCS	264 €
Temperature sensor	PCS	73 €
Wind sensor Teleco	PCS	321 €
Foot mounting (galvanization)	PCS	141 €
Foot mounting (galvanization + painting)	PCS	184 €
Foot mounting (inox)	PCS	346 €

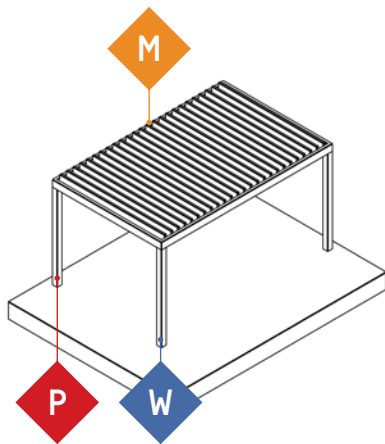

How to understand the markings



LEGEND:

-  location of motor position
-  location of power supply
-  location of water exit

ATTENTION!



Water exit is possible on same pole as electricity, but only if Type P is ordered as special option of water evacuation.

- minimal 1 water exit up to roof dimension 10m²
- minimal 2 water exit up to roof dimension 24m²
- minimal 3 water exit up to roof dimension 34m²

Order form

Soltec Bioclimatic Pergola SL

Step 1 / Client information

Client	Deliver to (when different)	Project
Name	Name	Name
Address	Address	Date
Phone	Phone	Requested date of delivery (week)
E-mail	E-mail	

With signoff of this Order form the Client declares, that the Client has read and accepts the General Terms and Conditions of Soltec d.o.o., which are published on www.soltec.si.

Stamp & signature

Step 2 / Product information

Type of pergola

- SL 160/28
- SL 170/28
- SL 170/36
- SL 240/36
- SL 240/60
- RT 240/36

Type of installation

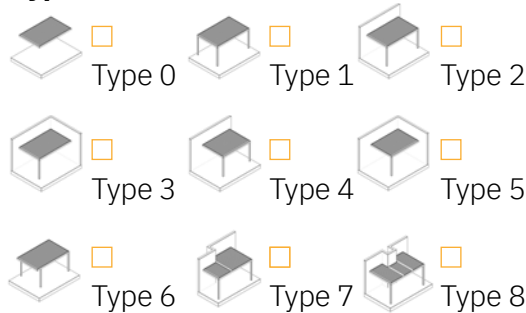

Dimensions (specify in mm)

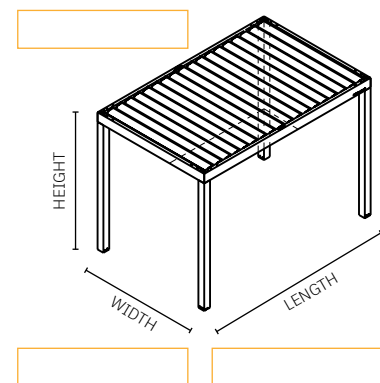

Quantity of Pergola

Number

Number of poles

- 0 poles
- 1 pole
- 2 poles
- 3 poles
- 4 poles
- additional pole:

Height of pergola

P1
P2
P3
P4

Hight of pergola 3-3.5 m is possible only with external foot mounting.
Extra cost of higher poles and external foot mounting is 180 €.

Colour

Standard

STRUCTURE

- Anthracite Grey RAL 7016FS
- Aluminium Grey RAL 9007FS
- Aluminium White RAL 9006FS
- Traffic White RAL 9016FS
- Oyster White RAL 1013FS
- Chocolate Brown RAL 8017FS
- RAL DB703FS

Non-standard

Subject to additional payment.

STRUCTURE

RAL no.
Finish

BLADES

- Anthracite Grey RAL 7016FS
- Aluminium Grey RAL 9007FS
- Aluminium White RAL 9006FS
- Traffic White RAL 9016FS
- Oyster White RAL 1013FS
- Chocolate Brown RAL 8017FS
- RAL DB703FS

BLADES

RAL no.
Finish

Soltec Bioclimatic Pergola SL

Step 3 / Drawing with marked specifications

Mark motor position, water exit and power supply on top view

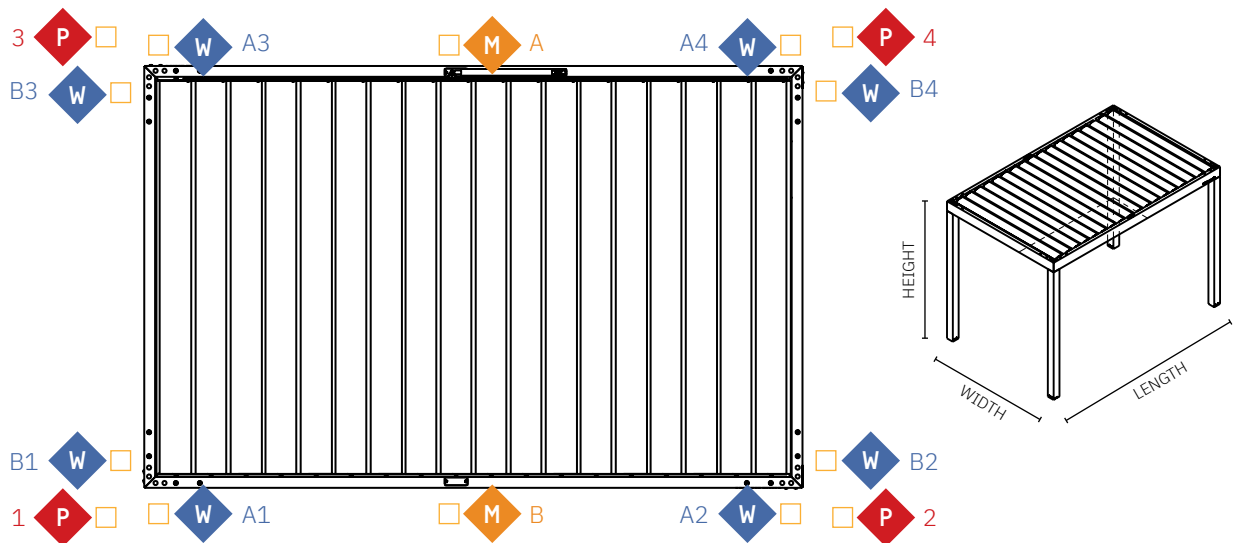

 location of motor position

 location of power supply





 location of water exit

-  · Water exit is possible on same pole as electricity, but only if Type P is ordered as special option of water evacuation.
 · Pergola must have min. 2 water exits!
 · Position of cutting is on pole foot.

Wall mounting

- standard
- optional 1
- optional 2
- optional 3
 - P1-P2
 - P3-P4
 - P1-P3
 - P2-P4

Foot mounting

- standard (inox) / internal
- optional / external
 - 
 - 
 - 
 - 

External foot mounting protection

- galvanization
- galvanization + painting
- inox

Blades opening way

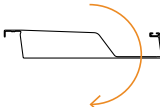
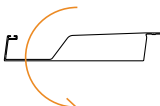
- A 
- B 

Soltec Bioclimatic Pergola SL

LED lights

A) LED lights integrated into the blades

- 0,5 m lenght
- 1 m lenght
- 1,5 m lenght
- RGB
- Neutral white 3200 - 5000°K
- Warm white 2200 - 3200°K
- Cold white >5000°K

B) LED strip lights

- RGB

Position of LED lights (mark on drawing)

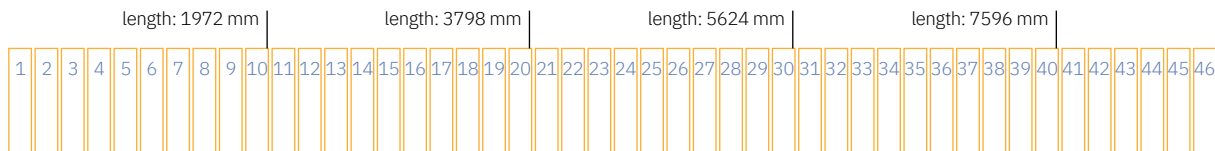

Step 4 / Options

ZIP blinds

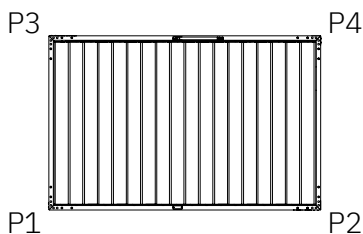

Fabric Serge

- 108101 grey-white
- 108108 grey
- 108118 grey-black
- 116101 linen-white
- 117101 pearl-white
- 117117 pearl

Fabric Soltis

+ 10%

Crystal full screen

+ 10%

Crystal window

Position

- P1 - P2
- P1 - P3
- P3 - P4
- P2 - P4

Colour of guides

- Same as pergola frame
- Different RAL no.

Motor

- standard
- Somfy

Additional comments

Soltec Bioclimatic Pergola SL

Sliding panels

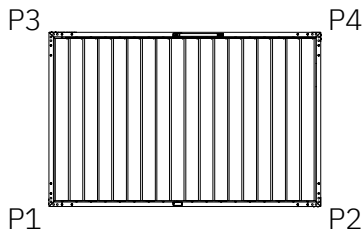

Position

- P1 - P2 P1 - P3
- P3 - P4 P2 - P4

Type

- wood
- alu
- screen

Sliding type

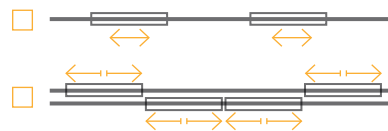

Number of panels

Dimension of panels (width in mm)

Frame colour / Standard

- grey anthracite RAL 7016
- grey aluminium RAL 9006
- white traffic RAL 9016

Frame colour / Non-Standard

Subject to additional payment +10%.

RAL no.

ALU infill colour / Standard

- grey anthracite RAL 7016
- grey aluminium RAL 9006
- white traffic RAL 9016

ALU infill colour / Non-Standard

Subject to additional payment +10%.

RAL no.

Fabric Serge

- 108101 grey-white
- 108108 grey
- 108118 grey-black
- 116101 linen-white
- 117101 pearl-white
- 117117 pearl

Fabric Soltis

+ 10%

Crystal full screen

+ 10%

Crystal window

dim.

Glass panels

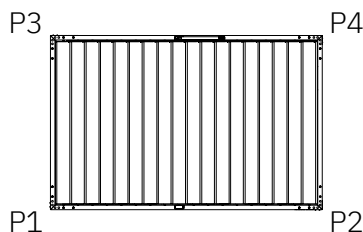

Position

- P1 - P2 P1 - P3
- P3 - P4 P2 - P4

Folding type

- 2 panels / 2 guides
- 4 panels / 2 guides
- 6 panels / 3 guides
- 10 panels / 5 guides
(only for SL 240/36 and SL 240/60)

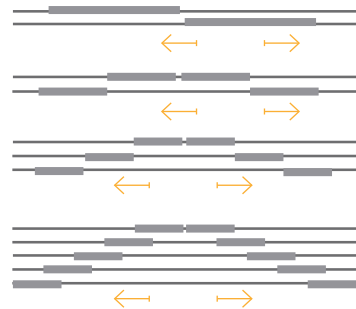

Number of panels

Dimension of panels (width in mm)

Soltec Bioclimatic Pergola SL

Step 5 / Accessories

Sensors

- Rain sensor
- Wind sensor
- Snow sensor (Rain + Temperature sensor)
- Temperature sensor
- Presence sensor

Heater Heliosa

Quantity

- White
- Anthracite

Control

- EVO
- Somfy
- Daisy

Sound system

Number of speakers

- Audio system
- Audio system + Bluetooth

Remote control

Quantity

- EVO / 42-channels
- Somfy / 4-channels
- Somfy / 1-channel

Step 6 / Options roof

Covers for non standard length

Subject to additional payment.

- Type A / Convex type
- Type B / Concave type

Fix roof integration

- Type C / Glass roof
- Type D / Aluminium sheet
- Type E / Aluminium sheet

Special water evacuation

Subject to additional payment.

- Type V
- Type P
- Type H

Step 7 / Hand drawing with marked specifications

Step 8 / Additional comments

To be filled by Soltec / manufacturer

Value
Shipping
In total
Offer number
Project reference number
Date

Technical description of the Bioclimatic Pergola system

The Bioclimatic Pergola SL product is a Bioclimatic Pergola consisting of aluminum components, columns, beams and rotating slats. The pergola is made in accordance with the harmonized standard SIST EN 13561. In accordance with this standard, we are issuing the technical approval and the CE marking. The declared property, according to the standard, is wind resistance up to class 3. The declaration of conformity is part of Instructions for use and maintenance.

A Bioclimatic Pergola as a shade differs from the ordinarily built canopies with a traditional roof, which, according to building laws and regulations, must withstand loads according to the regulations and the location of installation. The Bioclimatic Pergola is a shade where the blades must be opened in the event of heavy loads (wind, snow, etc.), which is stated in the Price list, The instructions for use and maintenance and the Catalog. The load-bearing capacity with closed blades is stated with the help of ready-made charts in the Price list and depends on the dimensions of the pergola. The charts show the functional load-bearing capacity of the blades (displacement of 1/200 of the span), depending on the additional load and the selected blade length. Depending on the desired load-bearing capacity, different pergola types can be selected (160/28, 170/28, 170/36, 240/36, 240/60). The user is obliged to comply with and apply the Instructions for use and maintenance and prevent loads that would not be in accordance with the limited functional load-bearing capacity. Soltec thus provides the Instructions for use and maintenance and, as an aid, offers electronic solutions with a weather sensor that ensures that the slats open automatically in the event of heavy snow loads or wind.

The functional load-bearing capacity of the blades, which represents the condition indicating a suspension of 1/200 of the span, is also in accordance with the displacement limit recommended by Eurocode for load-bearing elements of roofs (SIST EN 1990). When the displacements are not of key functional importance, they may be larger, in accordance with the agreement with the client. The calculated displacement due to own weight, together with the permitted additional load according to the chart, is 1/200 of the length. With this condition and in this respect, the Bioclimatic Pergola is also designed and complies with the provisions of Eurocodes that otherwise apply to built roofs.

Wind resistance

The Bioclimatic Pergola series of Bioclimatic Pergolas are designed as an outdoor living space and are not meant for permanent living. The Pergola frame with blades can hold up to strong forces dependent of the span and declared possible additional vertical loading in the tables with the price lists. The quality of Bioclimatic Pergola is declared accordingly to the European standard for shading systems EN 13561. All pergolas come with Technical approval and CE sign. According to the standard EN 13561 there are four classes for wind resistance.

Class	0	1	2	3
Wind speed resistance	< 28 km/h	max 28 km/h	max 38 km/h	49 km/h
Beaufort scale	< 4	4	5	6
EN 13561 pressure		4 kg/m ²	7 kg/m ²	11 kg/m²

All Bioclimatic Pergola structures with rotating blades are approved to the highest wind class 3. Further we designed the structure with the blades to bear even higher possible loads. The structure can bear wind loads up to 60 km/h. With wind higher then 60 km/h blades must be open as all accessories have to be retracted. In this way the structure can bear loads up to 120 km/h. We provide a wind and weather sensor to open the blades automatically in such cases.

Wind speed and wind load dependence is addressed differently by different standards and depends of lot of circumstances such as Location, Terrain, presence of bigger obstacles in the vicinity, etc. We design the structures according to the Eurocodes.

EUROCODE WIND/LOAD DEPENDENCE:

Terrain 0

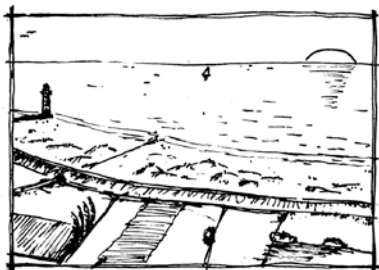

Terrain I

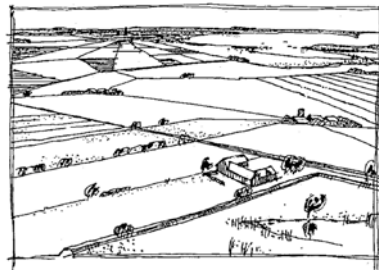

Terrain II

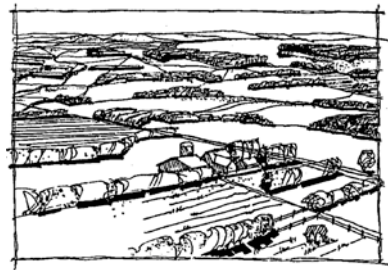

Terrain III

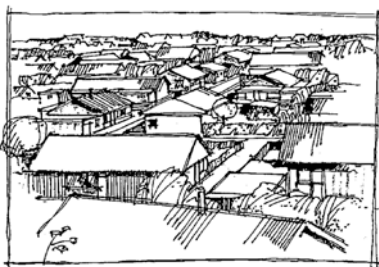

Terrain IV

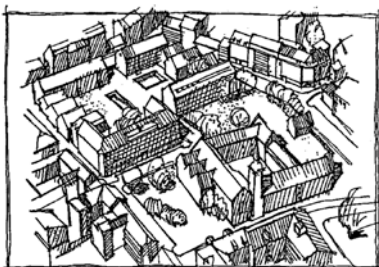

**WIND SPEED/PRESSURE
ROOF PRESSURE**

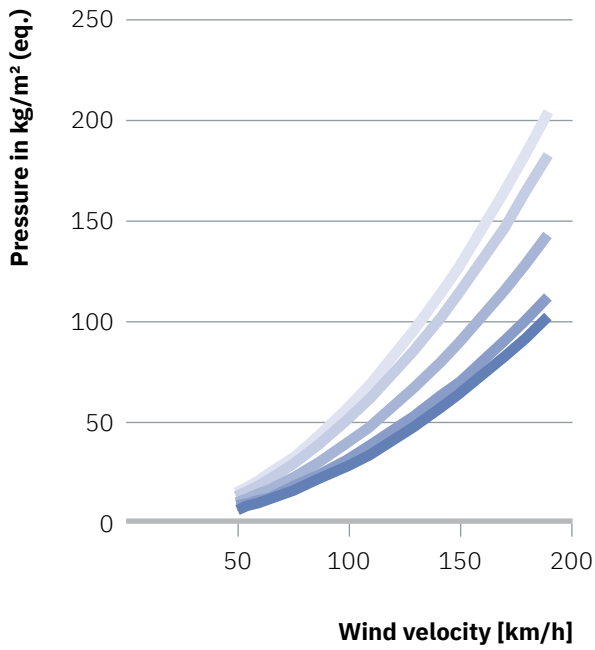

- Terrain 0 / Roof pressure
- Terrain I / Roof pressure
- Terrain II / Roof pressure
- Terrain III / Roof pressure
- Terrain IV / Roof pressure

**WIND SPEED/PRESSURE
BASIC PRESSURE
ACCORDING TO STANDARD EN 1991-1-4**

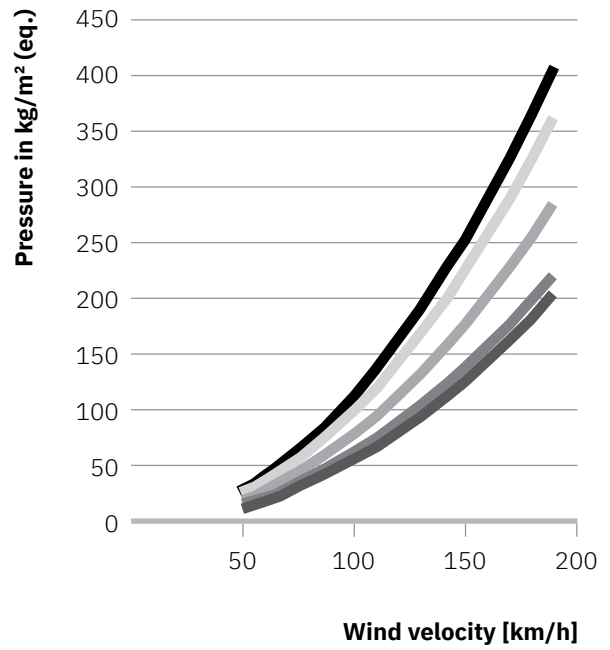

- Terrain 0 / Basic pressure
- Terrain I / Basic pressure
- Terrain II / Basic pressure
- Terrain III / Basic pressure
- Terrain IV / Basic pressure

BEAUFORT SCALE:

Beaufort number	Wind speed [km/h]	Description	Land conditions
0	<1	Calm	Calm. Smoke rises vertically.
1	1-5	Light air	Wind motion visible in smoke.
2	6-11	Light breeze	Wind felt on exposed skin. Leaves rustle.
3	12-19	Gentle breeze	Leaves and smaller twigs in constant motion.
4	20-28	Moderate breeze	Dust and loose paper raised. Small branches begin to move.
5	29-38	Fresh breeze	Branches of a moderate size move. Small trees begin to sway.
6	39-49	Strong breeze	Large branches in motion. Whistling heard in overhead wires. Umbrella use becomes difficult. Empty plastic garbage cans tip over.
7	50-61	High wind, moderate gale, near gale	Whole trees in motion. Effort needed to walk against the wind. Swaying of skyscrapers may be felt, especially by people on upper floors.
8	62-74	Fresh gale	Twigs broken from trees. Cars veer on road.
9	75-88	Strong gale	Larger branches break off trees, and some small trees blow over. Construction/temporary signs and barricades blow over. Damage to circus tents and canopies.
10	89-102	Whole gale, storm	Trees are broken off or uprooted, saplings bent and deformed, poorly attached asphalt shingles and shingles in poor condition peel off roofs.
11	103-117	Violent storm	Widespread vegetation damage. More damage to most roofing surfaces, asphalt tiles that have curled up and/or fractured due to age may break away completely.
12	>117	Hurricane force	Considerable and widespread damage to vegetation, a few windows broken, structural damage to mobile homes and poorly constructed sheds and barns. Debris may be hurled about.

General Sales Conditions and warranty

The following terms, together with such terms as are set forth on the Price List, Order Form, Offer, Confirmation of Order or Invoice, plans, specifications or other additional terms as are approved in writing by Soltec, shall constitute the entire contract between Soltec and the Buyer. The conditions contained herein shall take precedence over any other conditions and no contrary, additional or different provisions or conditions shall be binding on Soltec unless expressly accepted by Soltec in writing. Any quotation provided by Soltec does not constitute a firm offer and may be changed or revoked at any time. Such quotation, including calculations and descriptions made or supplied by Soltec ("Quotation") shall remain Soltec's property and Buyer agrees that such information contained in the Quotation is confidential and shall not be disclosed or otherwise used without Soltec's express prior written consent. This contract replaces any other preceding agreement between the parties relating to the sale of goods or provision of services. By placing the order, the Buyer accepts in full these General Sales Conditions. By accepting such conditions the Buyer acknowledges that he has the skills, capabilities, tools and staff to install properly Soltec products, according to Soltec's instruction manual and aligned with general and local regulations and best practice standards, hence becoming an authorized reseller of Soltec products.

1. Prices

- 1.1. Prices provided on Soltec's Price List, Order Form, Confirmation of Order or Invoices are expressed in Euros. The prices do not include any applicable VAT or other taxes.
- 1.2. Any discounts for distribution and reselling of Soltec products shall be agreed in writing. Except as explicitly mentioned otherwise on Soltec's Price List, Order Form, Confirmation of Order or Invoices or as otherwise agreed upon in writing by Soltec and Buyer, the price stated on the valid Soltec's Price List, Order Form, Confirmation of Order or Invoices is net without any deductions whatsoever.
- 1.3. All additional costs, including (but not limited to) charges for freight, packing, carriage, insurance, customs duties, fees for export, transit, import and any other permits and certificates as may be necessary, shall be borne by the Buyer.
- 1.4. If charges for packing, freight, carriage, insurance, customs duties or other additional costs are separately stated on Soltec's Price List, Order Form, Confirmation of Order or Invoices and included in the price stated thereon, Soltec reserves the right to adjust its price should the costs on which such additional charges are based be modified.
- 1.5. The supply of Soltec products not included in the price list, should take place only after Soltec has provided a quote directly on the customer's request.
- 1.6. Soltec reserves the right to change prices in case of altered quantity, color, size, or any other facts that are the basis for price calculation.
- 1.7. The Buyer may not legally claim the right of retention of payment of the price or of the delivery of the goods, and he cannot make any exceptions or raise any counterclaims, unless Soltec substantially breaches its obligations, despite a written warning of the Buyer, and does not provide adequate guarantee.

2. Taxes and duties

- 2.1. Unless otherwise agreed in writing, Soltec's prices are exclusive of any federal, state or local taxes or other other taxes which may now or hereafter be applicable to the transaction, the products, their sale, their value or their use or to any services performed in connection therewith.
- 2.2. The Buyer agrees to pay or reimburse any such taxes which Soltec or Soltec's subcontractors or suppliers are required to pay. Buyer shall furthermore be responsible for the import of the products into the country of delivery, if delivered outside of Slovenia.

3. Sales promotion

- 3.1. The Buyer, whereas this is a reseller or distributor to Soltec, agrees to use his best efforts to promote the sale of the products within his territory in and shall protect Soltec's interests with the diligence of a responsible businessman.
- 3.2. The Buyer shall provide and maintain an adequate organisation to promote sales and, where appropriate, after-sale service, with all necessary means and personnel, in order to ensure the fulfilment of his obligations throughout the territory.
- 3.3. The Buyer undertakes to strictly conform to the Soltec's marketing policy, especially with regard to the choice of products and their performance and the distribution channels, which must in any case be adequate for the trademark image of Soltec.
- 3.4. The Buyer shall take part, at his own expense, in the main fairs and exhibitions in his territory. Soltec reserves however the option to participate directly to any fair or exhibition in the territory and in such case the parties will bear their respective expenses.
- 3.5. The Buyer shall be responsible for all advertising necessary to adequately promote the Products within the territory. He agrees to regularly advertise and publicise the products as well as Soltec's name and trademarks in the territory. Any advertising and promotion regarding Soltec and/or the products shall be in strict accordance with the indications given by Soltec, in order to warrant that it conforms in all respects to the company's image and marketing policies.
- 3.6. Any advertisement materials regarding the products issued by the Buyer, including their presentation through Internet, shall strictly conform to Soltec's guidelines and must receive the prior approval of Soltec. The costs of all advertising and sale promotion activities shall, unless otherwise agreed, be borne by the Buyer.
- 3.7. The Buyer may advertise the products and/or his activity as reseller or distributor of Soltec's products on Internet, provided he informs Soltec so that the latter can check that such advertising conforms to his trademark image. The costs of such advertising will be borne, unless otherwise agreed, by the Buyer.

4. Soltec's support to the Buyer

- 4.1. Soltec shall provide the Buyer, at cost price, with all documentation relating to the products (brochures, price-lists, catalogues, etc.) needed by the Buyer for carrying out his commitments under the contract.
- 4.2. If such documentation needs to be translated in the language of the Buyer's country or otherwise adapted to the requirements of such country, the Buyer will carry out such translations or adaptations at his costs.
- 4.3. Unless otherwise agreed, any documentation expressly made for the Buyer's country shall be at the Buyer's charge.
- 4.4. At the end of this contract the Buyer shall return to Soltec any advertising material or other documentation provided to the Buyer which is still in the Buyer's possession.

5. Buyer's obligations to report market conditions

- 5.1. The Buyer shall with due diligence keep Soltec informed about his activities, market conditions and the state of competition (e.g. features and prices of competing products, marketing actions of competing firms, etc.) within his territory. He shall furthermore answer any reasonable request for information made by Soltec.
- 5.2. The Buyer shall further keep Soltec informed about the laws and regulations in force in the territory to which the products must conform (e.g. labelling, technical specifications, safety requirements, etc.) and shall require in the name and on behalf of Soltec any authorization which might be necessary for distributing or selling the products in the territory.
- 5.3. The Buyer shall further send an annual report on his activities.

6. Terms of Payment/Reservation of Title

- 6.1. Except as otherwise provided on the face of Soltec's Invoices or Confirmation of Order, payment shall be due all in advance prior to dispatching of products.
- 6.2. If Buyer does not observe the agreed dates of payment, Buyer shall, without any requirement of a formal notice from Soltec, pay interest to Soltec on overdue amounts from the date(s) due, at the rate of eight (8) percent per annum or any interest rate that is due on the basis of applicable local law. Payment of such interest does not release Buyer from its obligation to make payments when due.
- 6.3. Buyer shall not be entitled to any setoff of claims or retention rights ("Counterclaims"), unless such Counterclaims are based on claims or rights against Soltec that are either: (a) undisputed or (b) legally binding with final force and effect and non-appealable.
- 6.4. If, in the judgment of Soltec, the financial condition of Buyer, at any time during the manufacturing period or at the time the products are ready for dispatch, does not justify the continuance of the work to be performed by Soltec hereunder or the terms of payment specified, Soltec may require full payment in advance as well as in the event of Buyer's bankruptcy or insolvency or in the event any proceeding is brought against Buyer, voluntarily or involuntarily, under the bankruptcy or any insolvency laws.
- 6.5. Soltec shall be entitled to cancel any order then outstanding at any time during the period allowed for filing claims against the estate and shall receive reimbursement for its proper cancellation charges and expenses.
- 6.6. Soltec's rights under this paragraph are in addition to all rights available to it at law or in equity. Orders being placed and relevant terms of payment shall remain as specified, if the transportation, delivery, installation, commissioning or taking possession of the products or services is/are delayed or prevented due to reasons beyond Soltec's control, or if parts are missing, but to be supplied within a reasonable period of time.
- 6.7. In the event that any payment or payments are not made by Buyer in accordance with the terms or as may be otherwise agreed upon, Soltec, at its option, may terminate the underlying contract, and be entitled to claim damages.
- 6.8. The products shall be identified in the specific contract and risk of loss shall pass to Buyer when the products are placed in the hands of a carrier. Title to the products shall not pass to Buyer until all the amounts due to Soltec in respect of the delivery, including any interest and costs, have been paid.
- 6.9. Goods can only be returned with the express prior written approval of Soltec. The cost of transporting and processing returned goods (incoming goods, inspection including packaging, storage, etc.) will be borne by the Buyer.

7. Production Time/Delivery Time

- 7.1. Soltec products are intended Ex-Works EXW Incoterms 2010 (International Commercial Terms), company seat: Soltec d.o.o., Obrtna ulica 9, Dobova, Slovenia.
- 7.2. Soltec shall not be liable for any loss or damage to Buyer resulting from any delay in delivery.
- 7.3. Production time for any Soltec products starts when the Buyer has confirmed the offer in writing and technical plans and has provided advanced payment according to these General Sales Conditions.
- 7.4. The due date(s) on Soltec's Price List, Order Form, Confirmation of Order or Invoices are approximate and shall be reasonably extended if:
 - (a) information required by Soltec from Buyer to execute the order is not received in a timely manner;
 - (b) if changes to the Order are agreed upon by Soltec and Buyer;
 - (c) Soltec is not able to make timely production by reason of hindrances which, despite due care, Soltec cannot avoid (inclusive of those occurring in the works of its major suppliers or third parties), such as epidemics, pandemics, act of civil or military authority, mobilization of armed services, war, riots, strikes, boycotts, picketing, lock-outs or other disturbances, machinery breakdowns, accidents, labor conflicts, delayed or deficient deliv-

ery of necessary raw materials or semi-manufactured and manufactured products, the need to scrap important components due to defective casting, official or other measures of whatever kind, transport difficulties, natural catastrophes, and any acts of God;

or (d) if Buyer or a third party is behind schedule with work which it has to carry out, or late in fulfilling its contractual obligations (including, but not limited to failure by Buyer to observe the terms of payment).

- 7.5. Soltec shall not be liable for any loss or damage to Buyer resulting from any delay in production, except as noted below.
- 7.6. Buyer shall be entitled to cancel an order already being placed or refund of advanced payments or damages for delay in production, only if it can prove that said delay has been caused by direct fault of Soltec and that Buyer has suffered a loss as a result of such delay.
- 7.7. Notwithstanding anything to the contrary, damages for delayed production shall in no cases exceed one half (1/2) of one percent (1%) for every full week of delay and shall in no case whatsoever exceed a total of five percent (5%) of the sales price Ex-Works of that portion of the supplies which have been delayed. In no event shall any damages be due to Buyer for the first two (2) weeks of any delay.
- 7.8. It is the Buyer responsibility to take over the goods upon delivery and to inspect them. The Buyer will sign the bill of delivery with acknowledgment of receipt stating its name. The Buyer can authorize someone else to represent them in order to take over the goods.

8. Modification of Orders

- 8.1. Orders being placed may be revoked or modified by the Buyer only with written permission of Soltec. Changes to the original order being placed have to be communicated in writing and are subject to Soltec's acceptance. When the production for carrying out the order has already started prior to the modification or revocation of the order, the Buyer shall be charged with the cost of the material purchased or produced and which can no longer be used in relation to the modified or revoked order. Changes to any given order that is approved by Soltec automatically leads to an extension of the production time of the same order.

9. Soltec's Trademarks - Unfair competition - Confidentiality

- 9.1. The Buyer acting as a reseller or distributor to Soltec shall use Soltec's trademarks, trade names or any other symbols (hereafter «Trademarks»), but only for the limited purpose of advertising the sale of the products and identifying himself as a reseller or distributor of Soltec, such use of the Trademarks being made in Soltec's sole interest.
- 9.2. Any use of the Trademarks on advertising materials or on any other materials addressed to third parties or on Internet (especially on the Buyer's web site, if any) shall require the prior written consent of Soltec.
- 9.3. The Buyer agrees neither to register, nor to allow or favour the registration by third parties of any of the Trademarks (nor of any trademarks, trade names or symbols which are confusingly similar to the Trademarks), in the territory or elsewhere.
- 9.4. He furthermore agrees not to include the Trademarks in his own trade or company name.
- 9.5. The Buyer shall inform the Supplier, as soon as he gets notice of it, about any acts of unfair competition or infringement of Soltec's Trademarks or other intellectual property rights (e.g. patents) by third parties and concerning the Products. He shall also assist Soltec in defence of his rights in the territory.
- 9.6. The Buyer shall not reveal either during the currency of this contract or after its termination or expiration Soltec's trade or commercial secrets or other confidential information (e.g. technical data regarding the products, discount policies, general conditions of sale, warranty conditions, etc.) that has come to his knowledge through his activities as reseller or distributor of Soltec, and agrees not to use such secrets or confidential information for purposes other than those of the present contract.

10. Warranty

- 10.1. Soltec warrants that the products will adhere to Soltec's description and that the specifications will be the kind and quality described in the contract and will be free of defects in workmanship or material. Should any failure to conform to this warranty appear on the date of delivery, Soltec shall, in complete fulfillment of its liabilities under this warranty, if given written notice by Buyer, correct by repair or replacement, at discretion of Soltec.
- 10.2. The Buyer acknowledges that there may be deviations in the color of the delivered goods compared to the sample shown in Price List, Soltec's documentation or presented photos or material, and that slight color deviations may occur when the surface is enameled. Such deviations do not give the Buyer the right to any claim or demand for the annulment of agreement or to refuse delivery and/or payment of the products.
- 10.3. Soltec can arrange the transport of the products upon request, on behalf of the Buyer and at his risk and costs.
- 10.4. Buyer shall be obliged to inspect the Products upon delivery: inspection shall regard amongst others appearance, status, quantity and size of products. Within ten (10) days after delivery and before installation, the Buyer will report to Soltec about any visible defects or damages or non-conformity of parts and products, marking them on the delivery note and report them to Soltec.
- 10.5. Defects or damages or non-conformity, including any possible missing parts, which are reported at a later date will not be accepted by Soltec and, except for any latent defects, any failure to inspect the products within this period shall be deemed as an acceptance of the products.
- 10.6. Date of delivery starts when the products leave Soltec's facility on an Ex-Works basis. Latent defects shall be sent to Soltec by the Buyer via registered mail or the official e-mail address immediately after discovery and no later than one (1) month from delivery. Any complaints made at a later date will not be accepted.
- 10.7. Buyer shall fully cooperate with Soltec and make the products available for inspection if so requested by Soltec, by supplying photographic evidence and/or returning defective components on the address of Soltec. In no event will Soltec be responsible for providing access to the defective part or parts or for the disassembly, removal, or reinstallation of the products or components thereof.
- 10.8. The warranty contained in this section will terminate immediately if Buyer or a third party undertakes inappropriate or improper use, modification or repairs or if Buyer, in case of a defect, does not immediately take all appropriate steps to mitigate damages and notify Soltec in writing of its obligations to remedy such defect.
- 10.9. Correction of nonconformities in the manner and for the period of time provided above shall constitute fulfillment of all liabilities of Soltec to the Buyer, whether based on contract, negligence or otherwise, with respect to such products. The warranty provided for in this Section shall not be applicable if Buyer is in arrears with any payments due.
- 10.10. Returns of goods, for any reason due, must first be authorized by Soltec and, unless otherwise agreed, sent to the headquarters of Soltec at the expenses of the buyer.
- 10.11. Soltec assumes no responsibility or liability for any accidents caused to third parties or direct and indirect damages to property during the installation phase, as well as any direct and indirect damages to goods caused by improper installation.
- 10.12. Soltec shall not be liable in any civil, criminal and/or administrative proceedings for the damage caused by unauthorized use of the products and/or following their use outside the parameters of performance specifically provided for each specific type of product.
- 10.13. Warranty of Soltec's product is applicable as follows:
- 10.14. The Buyer acknowledges and accepts that the value of the components that have to be replaced under warranty because recognized as originally defective, decreases in time, with the exception of motors and automation (control units, transformers and other possible electronic parts), which is calculated according to the following depreciation parameters:
1st and 2nd year 100% of the value;
3rd year 60% of the value;
4th year 40% of the value;
5th year 20% of the value.
- 10.15. The warranty is limited to the repair or replacement at the expense and choice of Soltec of the parts affected by faults and/ or defects and/or non-compliant with the advised quality.
- 10.16. The customer is not entitled to claim any other compensation or damages from Soltec, such as installation costs, travel expenses and salaries. Installation and maintenance of goods must always be performed in accordance with the Installation manual and User manual instructions.
- 10.17. Furthermore, resellers of Soltec products are responsible to perform the installation as well as any further maintenance as needed and instruct the final user according to the Instructions Manual.
- 10.18. Qualified personnel must be appointed to carry out any electrical connections, grounding and any intervention on the electrical systems and any interventions carried out by unauthorized personnel invalidate the warranty relieving Soltec from any liability arising in any way.
- 10.19. Warranty cannot be claimed in case of damage to goods from improper use and / or inadequate maintenance. Incorrect use can be understood as any abuse, dangerous handling, incorrect or compulsive use and improper repair or modification.
- 10.20. Soltec's warranty does not apply in case of damages caused during harmful environmental conditions, riot, civil commotions or war, transport or storage, errors caused by unauthorized repairs by third parties and in case for any malfunctions or damages caused by parts that have not been approved by Soltec's technical department.
- 10.21. The warranty also does not apply in the event of improper use or installation, in case of damages caused by painting, drilling, corrosion, saltiness, temporary or permanent change in environmental factors, installation for purposes others than the ones the product was designed for. Soltec shall not be liable for direct, indirect, incidental or consequential damages such as, but not limited to, loss of profits or revenue, damage or loss of other property or Products or cost of capital.
- 10.22. The remedies of Buyer set forth herein are exclusive and Soltec's liability with respect to any contract or sale or anything done in connection therewith, whether in contract, in tort, under any warranty, or otherwise, shall not, except as expressly provided herein, exceed the cost of the Products or part on which such liability is based.

11. Governing law

- 11.1. This contract shall be governed by and construed in accordance with the laws of the Republic of Slovenia, without any regard to this country's or any other jurisdiction's conflicts of law principles.
- 11.2. Buyer and Soltec stipulate and agree that the court of competent subject matter jurisdiction for the city of Krško, Slovenia shall have jurisdiction and both parties agree that such venue is proper in such courts for all actions or proceedings with respect to these General Sales Conditions.

Bioclimatic Pergola		Other product / projects Blinds, Roller Blinds, Sliding / folding panels, Sunbreakers
Structure	7 Years	2 Years
Motors	2 Years	
Led lights	1 Year	
Electronic parts	2 Years	
Fabrics	2 Years	
Other parts and components	2 Years	

Patent

A specially designed blade, an integral part of the Bioclimatic Pergola, is made from extruded aluminium and patented and patent-protected SI 24401 A. All standard parts are produced in inox.

This watertight roofing blade is the basic structural element. When in a sequential sectional layout, it forms a water tight cover of exterior surfaces, resistant to loads such as wind and snow. The blades rotate and allow opening, thus regulating the balance of shade and sun exposure. This provides us with an excellent exterior living space in all seasons and ensures long-term use.

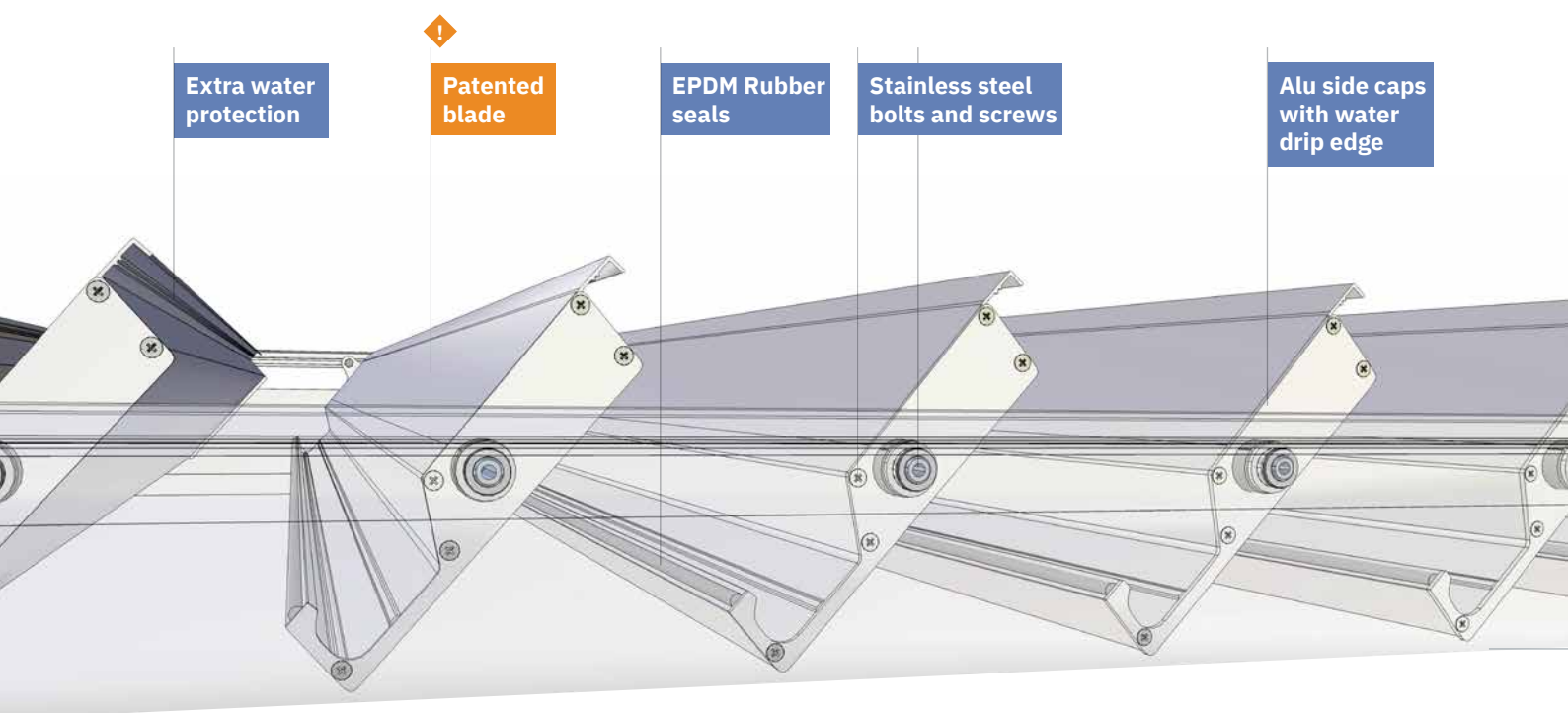

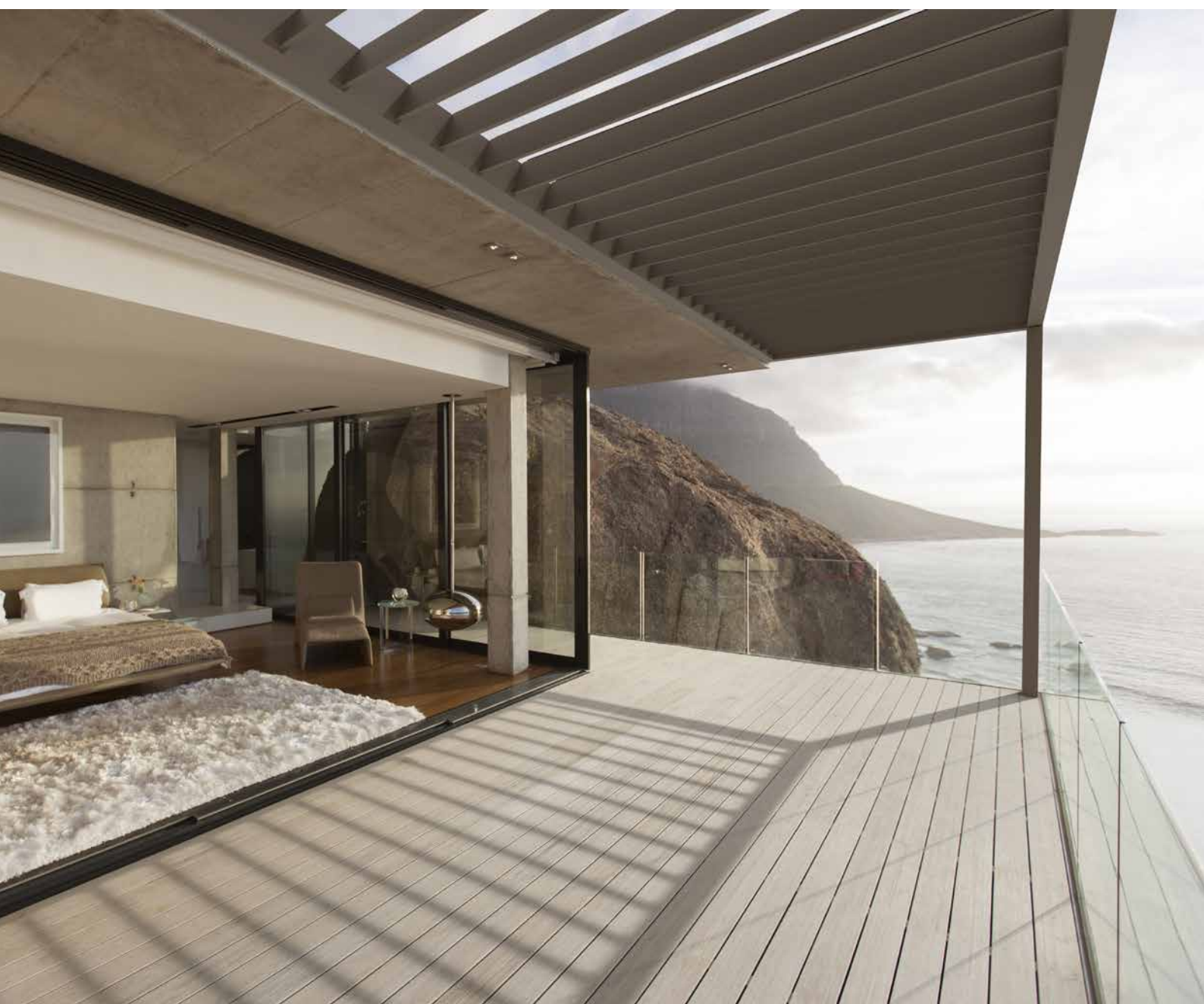

Our outdoor products



Soltec **Bioclimatic Pergola**

We produce innovative bioclimatic pergolas that are characterised by technical perfection, aesthetic appearance, and functionality. We strive to ensure that technological progress and sustainability go hand in hand. We want to leave our mark, so we like to play with different solutions. The latest of these is the cabrio pergola, where the slats fold to the side and give you an unobstructed view of the sky.

Soltec **Carport**

The Soltec carport, with its elegant lines, blends in with the modern architecture of the house, while boasting incredible reliability. It is made of inox and aluminium. But we haven't stopped there. We know there's always a shortage of storage space around the house, so you can add a shed to your new carport for tyres, tools, bikes, and everything you've never been able to stow away before. And for owners of electric vehicles, there's the Solar Pack, which turns your carport into a self-sustaining charging station.



Soltec **Multiport**

The Soltec multiport is a universal canopy that allows you to design it your way. You can use glass, aluminium, or greenery for the roof. Glassport, aluport and greenport are all solutions that allow you to have a unique canopy at the entrance, on the balcony, on the terrace, or wherever you need protection from the weather. The materials and design match to both the carport and the bioclimatic pergola for a uniform and tidy look around the home.

Soltec **Outdoor Kitchen**

Soltec outdoor kitchens are designed to seamlessly blend function and aesthetics. Imagine expansive work tops for prepping culinary masterpieces, high-quality equipment built to last through any weather, and all of it wrapped in a design that complements your outdoor space. Craft your ideal culinary haven with our vast selection of worktops, ALU composite claddings, handles and add state of the art equipment and accessories.



Soltec **Waste enclosure**

The Soltec waste enclosure is a commitment to sustainability, functionality, and style. Each element is thoughtfully designed to aesthetically complement their basic functionality. High-quality, weather-resistant materials ensure a long life and easy maintenance. Our commitment to perfection is reflected in the thoughtful design of our waste enclosures, which not only integrates functionally into your everyday life, but also aesthetically complements your pergola, carport and other Soltec products.



2-year warranty on electronic equipment and components



7-year warranty on the structure of Bioclimatic Pergola

7 year warranty, made in EU, fully certified

INOX
STAINLESS
STEEL



To ensure optimal quality, Bioclimatic Pergola is in accordance with the following EN standards:

- EN 1990: **Basis of Structural Design**
- EN 1991: **Actions on structures**
- EN 1991-1-1: **General actions - Densities, self-weight, imposed loads for buildings**
- EN 1991-1-3: **General actions - Snow loads**
- EN 1991-1-4: **General actions - Wind actions**
- EN 1991-1-5: **General actions - Thermal actions**
- EN 1993: **Design of steel structures**
- EN 1998: **Design of structures for earthquake resistance**
- EN 1999: **Design of aluminium structures**
- EN 1090: **Execution of steel and aluminium structures**
- EN 13561: **External blinds and awnings. Performance requirements including safety**
- EN 60335-1: **Household and similar electrical appliances - Safety - Part 1: General requirements**
- EN 60335-2-97: **Household and similar electrical appliances. Safety. Particular requirements for drives for rolling shutters, awnings, blinds and similar equipment**

soltec
More life.

SOLTEC d.o.o.
Obrtna ulica 9
8257 Dobova
Slovenia, EU

+386 7 45 22 126
+386 51 650 850
info@soltec.si
www.soltec.si