

PRICE LIST

Carport





Index

- 4 Our manifesto
- 6 Timeline
- 8 What are our fundamental values?
- 10 Outdoors, but under the roof
- 12 Models
- 17 Colours

PRICE LIST

- 18 **1 car** / Soltec **Carport** SL 170
- 20 **1 car** / Soltec **Carport + Back Box** SL 170
- 22 **1 car** / Soltec **Carport + Left Box** SL 170
- 24 **1 car** / Soltec **Carport + Right Box** SL 170
- 26 Types of installations **Carport** SL 170

- 28 **2 cars** / Soltec **Carport** SL 240
- 30 **2 cars** / Soltec **Carport + Back Box** SL 240
- 32 **2 cars** / Soltec **Carport + Left Box** SL 240
- 34 **2 cars** / Soltec **Carport + Right Box** SL 240
- 36 Types of installations **Carport** SL 240

OPTIONS

- 38 Possibilities
- 40 Doors & Accessories
- 41 Wall panels
- 42 Roof
- 43 Special water evacuation
- 44 Foot mounting
- 45 Wall mounting

- 46 Order form
- 66 General Sales Conditions and warranty
- 70 Our products
- 72 Contact

Our manifesto



Soltec. *More life.*

SOL TEC

There is no life without sun and that is why the sun is the core of our name. It is not only part of our name, but it also represents actions, values, thinking, purpose, ideas and more. **We love the sun and we love life.** Above all, we strive to make people around us feel the same way.

We are aware that every day cannot be sunny, and even on a sunny day, we still need the help of a shadow.

That is why the other half of the Soltec name represents technology, development and perfection of solutions that transform an unstable external environment into quality spaces of reliable safety, functionality and superior living comfort, which constantly give people a feeling and confirmation that life is beautiful.

And we want more of that life.

WHO ARE WE?

Energy, curiosity and a desire to create new products make us feel alive. **Self-confidence, perseverance and knowledge** give us strength and stability in solving even the most demanding challenges.

Tidiness, care and a sense of aesthetics have become important aspects of our work, as we always strive to make the people around us feel good.

HOW DO WE WORK?

At Soltec, the well-being of people is important, so we try to look at every situation from a positive point of view. We spread knowledge and information on how to achieve **superior living comfort, while at the same time inspiring people to recognize everything beautiful, comfortable and of high quality.**

Timeline



OUR STORY

The beginnings of Soltec date back to the 1999, when engineer Mirko Požar opened a small workshop in Slovenia for the production of blinds. His entrepreneurship, ability to perceive opportunities and development orientation are the reasons why the company has become a real source of developing innovative shading solutions.

With the right vision and hard work, Soltec developed into **the most important developer and manufacturer of innovative and quality shading solutions in the region.**

Today, Soltec's most important products are bioclimatic pergolas, multiports of all kinds (carports, glassports, aluports greenports), outdoor kitchens, waste enclosures, and various architectural shading systems.

Despite its rapid growth, Soltec maintains the values of a family business. We are especially proud of the high level of trust on the international market.

Today, our mission is to help you **improve and increase your living space, raising the level of comfort, safety and functionality with products that are made with you and just for you.**

2017

Sliding panels

2018

Folding panels

2019

Lifting panels
*4 000 m² of
new production
capacities*

2020

Carport

2021

Glassport

2024

*Bioclimatic
pergola
Cabrio*
*Carport with
Solar Pack*
Greenport
*Outdoor
kitchen*
*Waste
enclosure*

*WELCOME TO SOLTEC, TO WORLD
OF HIGH LIVING COMFORT.*

*“ We are committed to the
promise that with Soltec outdoor
products, we will transform
exteriors into high-quality, safe
and comfortable spaces, and
always put customers at the
center of our operations. ”*

Mirko Požar
CEO



What are our fundamental values?

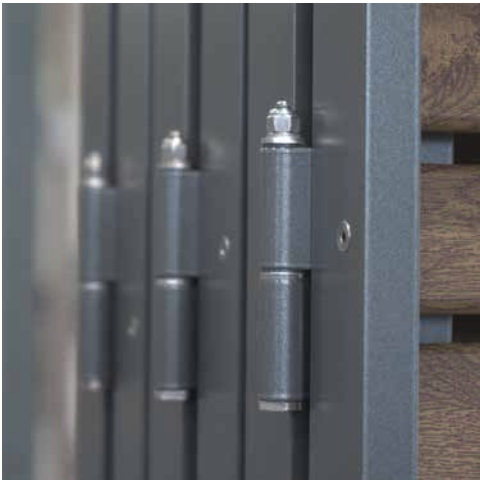

RELIABILITY.

With perseverance and honesty we fulfill all our agreements. If we encounter challenges along the way, we always find solutions to them, so our colleagues and partners can rely on us.

EXCELLENCE.

We are constantly upgrading our knowledge and competencies and thus pushing the boundaries of the known. Each of us does our job in a quality and timely manner, ensuring that our products and services are to the great satisfaction of our customers.



INNOVATION.

We are creators of change and we create novelties with passion. We learn and create with you and for you. With new approaches, we are paving different paths so that our products are always functional and modernly designed, and the solutions are bold and personalized only for you.

PARTNERSHIP.

We build respectful relationships between employees and partners. Each of us takes on personal responsibility for our own success, for the success of the project, department and company. At the same time, we are distinguished by our team spirit, as we know how to help each other to achieve the set goals together.



CONFIDENCE.

We are honest with each other. We do what we think and say. We stand by our clients and work with them to find the best solutions. We believe in ourselves, in our colleagues and partners, so we are confident in our joint success.



Outdoors, but under the roof

A modern solution
for protecting your
car from unwanted
weather conditions

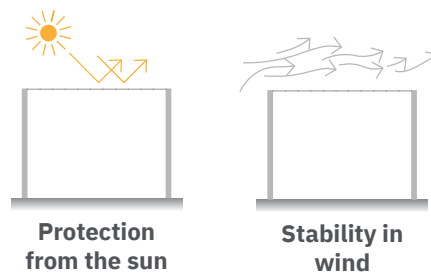
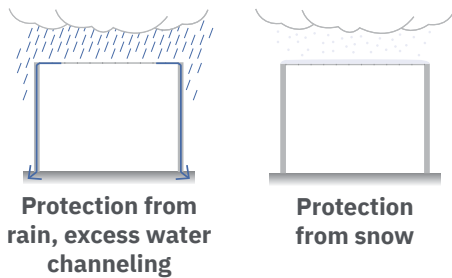

Shields your vehicle
and protects against
external influences

WHY CHOOSE SOLTEC CARPORT?



**Strong frame
reinforcement under
45° angle.**



**Frame fixation
without visible
screws.**



**High performance of
solid profiles.**

INOX

**All standard parts
and screws are in
stainless steel.**



**High quality insulated
roof panels**



**Customer support and
education.**



**Simple and fast
installation.**



**Complete support from
design to production and
installation of bigger
custom made projects.**



Models

1
car

Soltec **Carport** SL 170

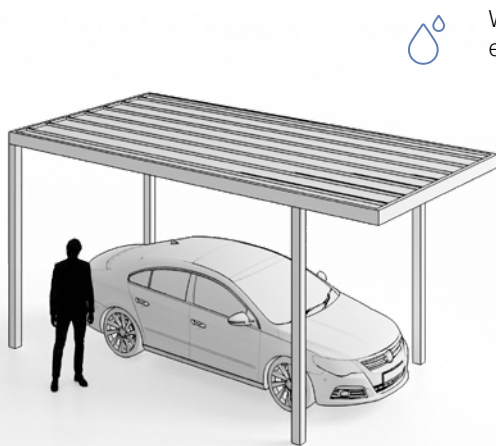

Water evacuation



High quality insulated panels



Possibility of installing LED lights

Width	3140 mm
Max Length on 2 posts*	6000 mm
Max Length on 3 posts*	8000 mm

Soltec **Carport + Back Box** SL 170

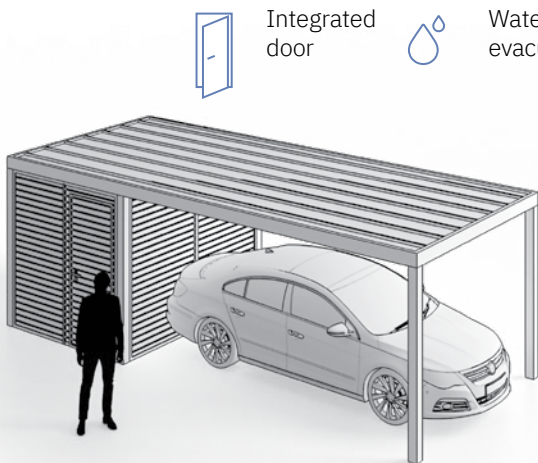

Integrated door



Water evacuation



High quality insulated panels



Possibility of installing LED lights

Width	3140 mm
Max Length on 3 posts*	8000 mm
+ Box dimensions	up to 9.4 m ²



100 kg/m² max snow load
(secondary beam profile on every 1200 mm)



160 kg/m² max snow load
(secondary beam profile on every 600 mm)



240 kg/m² max snow load
(secondary beam profile on every 300 mm)

Roof has 2% drop due to water runoff towards water exits. Resulting in posts of different heights.

* Max. distance between posts 4,7 m (3 m for load 240 kg/m²).

1
car

Soltec **Carport +** Left Box SL 170



Integrated door



Water evacuation



High quality insulated panels



Possibility of installing LED lights

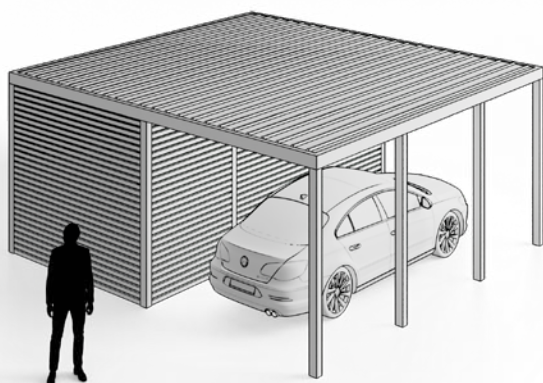

Width	6000 mm
Max Length on 3 posts*	8000 mm
+ Box dimensions	up to 24 m ²

Soltec **Carport +** Right Box SL 170



Integrated door



Water evacuation



High quality insulated panels



Possibility of installing LED lights

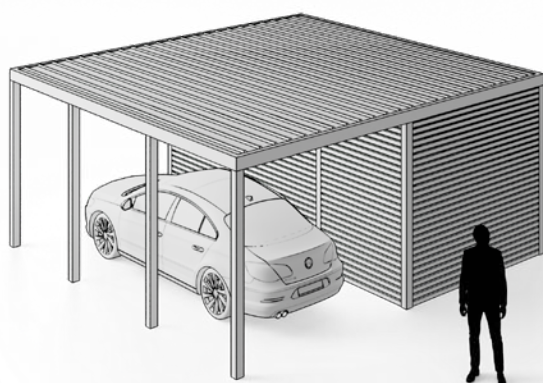

Width	6000 mm
Max Length on 3 posts*	8000 mm
+ Box dimensions	up to 24 m ²



100 kg/m² max snow load
(secondary beam profile on every 1200 mm)



160 kg/m² max snow load
(secondary beam profile on every 600 mm)



240 kg/m² max snow load
(secondary beam profile on every 300 mm)

Roof has 2% drop due to water runoff towards water exits. Resulting in posts of different heights.

* Max. distance between posts 4,7 m (3 m for load 240 kg/m²).

2
cars

Soltec **Carport** SL 240

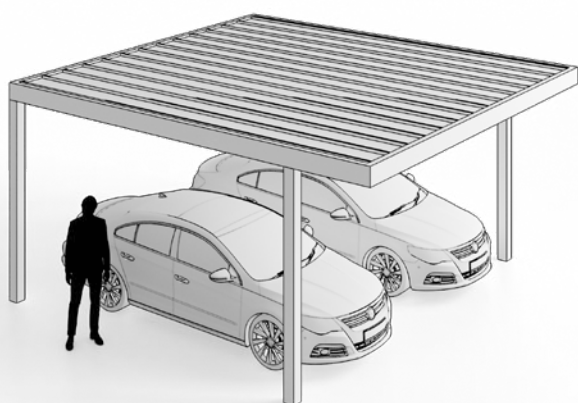
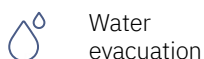

Width	6000 mm
Max Length on 2 posts*	6000 mm
Max Length on 3 posts*	8500 mm

Soltec **Carport + Back Box** SL 240

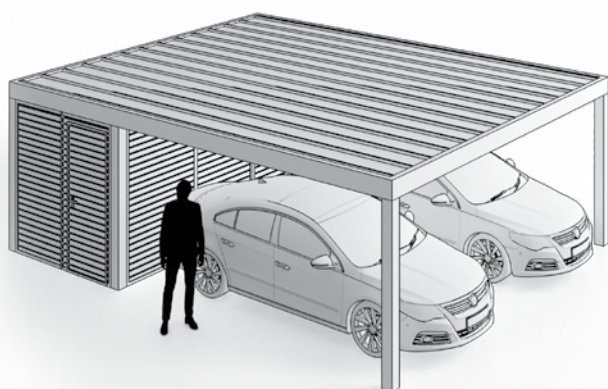
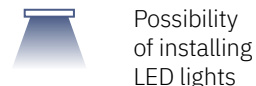
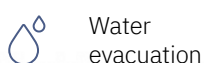

Max width	6000 mm
Max Length on 3 posts*	8500 mm
Box dimensions	up to 18 m ²



100 kg/m² max snow load
(secondary beam profile on every 1200 mm)



160 kg/m² max snow load
(secondary beam profile on every 600 mm)



240 kg/m² max snow load
(secondary beam profile on every 300 mm)

Roof has 2% drop due to water runoff towards water exits. Resulting in posts of different heights.

* Max. distance between posts 4,7 m (3 m for load 240 kg/m²).

2
cars

Soltec **Carport +** Left Box SL 240



Integrated door



Water evacuation



High quality insulated panels



Possibility of installing LED lights

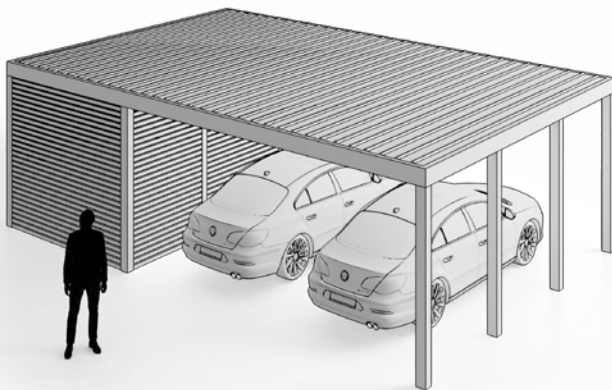

Width	8500 mm
Max Length on 3 posts*	8500 mm
Box dimensions	up to 25.5 m ²

Soltec **Carport +** Right Box SL 240



Integrated door



Water evacuation



High quality insulated panels



Possibility of installing LED lights

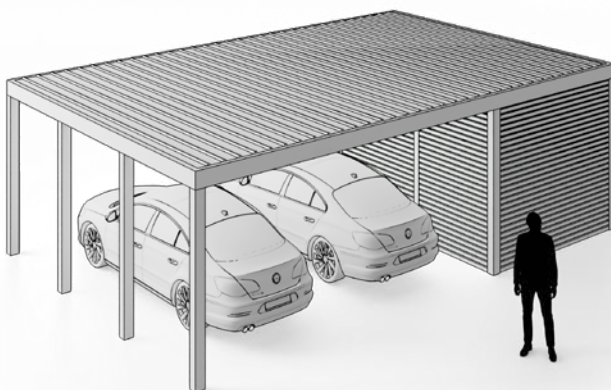

Width	8500 mm
Max Length on 3 posts*	8500 mm
Box dimensions	up to 25.5 m ²



100 kg/m² max snow load
(secondary beam profile on every 1200 mm)



160 kg/m² max snow load
(secondary beam profile on every 600 mm)













240 kg/m² max snow load
(secondary beam profile on every 300 mm)

Roof has 2% drop due to water runoff towards water exits. Resulting in posts of different heights.

* Max. distance between posts 4,7 m (3 m for load 240 kg/m²).



Colours

	Colours	Surface
STRUCTURE* Standard	Anthracite Grey RAL 7016FS 	Fine structure
	Aluminium Grey RAL 9007FS 	Fine structure
	Aluminium White RAL 9006FS 	Fine structure
	Traffic White RAL 9016FS 	Fine structure
	Oyster White RAL 1013FS 	Fine structure
	Chocolate Brown RAL 8017FS 	Fine structure
	RAL DB703FS 	Fine structure
ROOF / BOX & WALL PANELS** Standard for Insulated panel 3 cm (duotone)	Grey White RAL 9002FS  Grey White RAL 9002FS	Matt or Smooth
	Aluminium White RAL 9006FS  Grey White RAL 9002FS	Matt or Smooth
	Anthracite Grey RAL 7016FS  Grey White RAL 9002FS	Matt or Smooth
Optional	<p>Customize your Carport by selecting the colour of your choice from more than 1600 existing RAL colours, different glossy and finishing standard.*</p> <p>RAL 1000 > RAL 9023</p> 	<p>Different gloss levels are available.*</p> <p>Gloss levels: < 30 % matt > 65 % satin > 80 % gloss</p> <p>Different microstructure available.*</p> <p>Microstructure: Fine structural powder coating (deep matt)</p>

*Subject to additional payment. Gloss levels are +- 5 % accurate.

* Colour for STRUCTURE (profile, posts, secondary beam profile) and Box Infill (Aluminium Expanded Metal Sheet, Aluminum square profil 20/20) as marked in Price list, page 61 and 63.

** Colour for Insulated panel 3 cm (ROOF / BOX & WALL PANELS) as marked in Price list, page 61, 63 and 64.

1
car

Price list

Soltec Carport

SL 170

	Snow load [kg/m ²]	Number of cars	Width [mm]	Max Length [mm]	Max Height [mm]	Max Area [m ²]	Price €/pc
Carport SL 170 / 100	100	1	3140	5000	2800	16	6.539 €
Carport SL 170 / 160	160	1	3140	5000	2800	16	7.042 €
Carport SL 170 / 240	240	1	3140	5000	2800	16	9.013 €
Carport SL 170 / 100	100	1	3140	5500	2800	17	7.192 €
Carport SL 170 / 160	160	1	3140	5500	2800	17	7.746 €
Carport SL 170 / 240	240	1	3140	5500	2800	17	9.914 €
Carport SL 170 / 100	100	1	3140	6000	2800	19	7.473 €
Carport SL 170 / 160	160	1	3140	6000	2800	19	8.048 €
Carport SL 170 / 240	240	1	3140	6000	2800	19	10.301 €
Carport SL 170 / 100	100	1	3140	6500	2800	20	8.070 €
Carport SL 170 / 160	160	1	3140	6500	2800	20	8.661 €
Carport SL 170 / 240	240	1	3140	6500	2800	20	11.086 €
Carport SL 170 / 100	100	1	3140	7000	2800	22	8.479 €
Carport SL 170 / 160	160	1	3140	7000	2800	22	9.103 €
Carport SL 170 / 240	240	1	3140	7000	2800	22	11.652 €
Carport SL 170 / 100	100	1	3140	7500	2800	24	8.766 €
Carport SL 170 / 160	160	1	3140	7500	2800	24	9.413 €
Carport SL 170 / 240	240	1	3140	7500	2800	24	12.048 €
Carport SL 170 / 100	100	1	3140	8000	2800	25	9.119 €
Carport SL 170 / 160	160	1	3140	8000	2800	25	9.793 €
Carport SL 170 / 240	240	1	3140	8000	2800	25	12.535 €

Number of posts depend on the selected type of Carport. Four posts with robust external foot mounting are included in price. Every additional post is charged according to the price list on page 38.

Carport structure is designed using the Eurocode standards. It is assembled according to EN 1090 standard. The prescribed maximal loads are calculated for three different scenarios, for maximal combined load of 100, 160 and 240 kg/m². These loads are already multiplied by safety factors and include wind and snow loads.

Limit loads and special requirements:

The bearing structure is designed for the utilization of the profiles material up to 80% under the prescribed maximal loads. The displacements of the structure (under self load) are limited to 1/500 x W, where W is the width of the Carport (Length of the secondary beam profile). Under full combination of snow and wind load the displacements are limited to 1/100 x W. The absolute displacements at the maximal loads and maximal span can reach 7 cm at span 6 m at the maximal loads. In the fully loaded condition with wind and snow it is advisable to remove the snow when the snow reaches a characteristic load of 75 kg / 125 kg / 180 kg according to the Eurocodes ((first/second/third scenario). Even though the bearing capacity is higher, in this way the structure remains in a aesthetically pleasant shape. Special attention is necessary with choosing the right variant of the Carport. For different countries and different locations, different maximal prescribed loads are defined by the Eurocodes. It is necessary to choose the Carport variant, which is sufficient for the location and layout for which it is meant for. In different European countries there are different laws and regulations regarding Carport structures. It is possible, that the user has to acquire a building permit for the Carport structure. The building permit documentation and foundation of the Carport is the responsibility of the user. It is suggested to use a 25 cm thick concrete foundation plate for the cars and foundation of the carport.

Prices are defined and expressed in EUR. The prices are always before VAT. Any discounts shall be agreed upon in written form. The prices are ex-works Soltec headquarters. Packaging excluded.

1
car

Technical details

Soltec Carport

SL 170

Roof cover	Insulated panels 3 cm
Frame	170/120
Secondary beam profile	80/50
Post	120/120
Width	3140 mm
Max Length on 2 posts (max distance between posts 4,7 m)	6000 mm (overhang 1,3 m)
Max Length on 3 posts (max distance between posts 4,7 m)	8000 mm
Foot type (optional: painting or stainless steel)	External 120 - galvanized
N° of water exits	2
Max snow load - secondary beam on every 1200 mm	100* kg / m ²
Max snow load - secondary beam on every 600 mm	160* kg / m ²
Max snow load - secondary beam on every 300 mm	240* kg / m ²

PROFILE 17

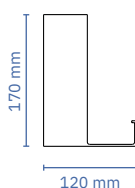

POSTS

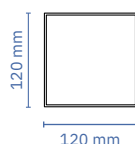

SECONDARY BEAM PROFILE

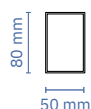

ROOF

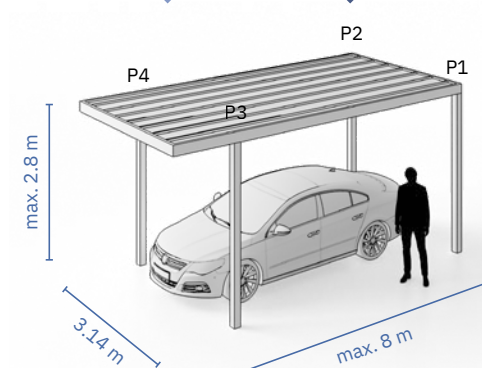
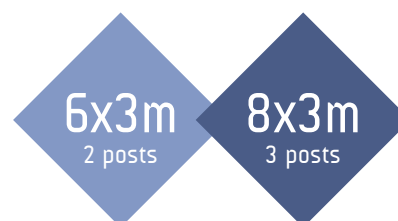
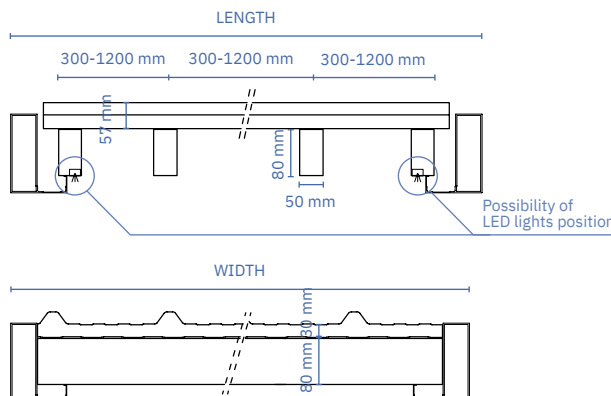

The image is symbolic and applies to all types. For max. dimensions for each type see Order form.

ROOF INCLINATION

Roof has 2% drop due to water runoff towards the water exits. Resulting in poles of different heights.

WATER EXITS

Water exits are on P1 and P2.

HIGH CORROSION RESISTANCE

Frame parts are made exclusively of aluminium and stainless steel.

* Carport structure is designed using the Eurocode standards. It is assembled according to EN 1090 standard. The prescribed maximal loads are calculated for three different scenarios, for maximal combined load of 100, 160 and 240 kg/m². These loads are already multiplied by safety factors and include wind and snow loads.



1
car

Price list

Soltec **Carport + Back Box** SL 170

	Snow load [kg/m ²]	Number of cars	Width [mm]	Max Length [mm]	Max Height [mm]	Max Area [m ²]	Price €/pc
Carport SL 170 / 100	100	1	3140	5000	2800	16	6.539 €
Carport SL 170 / 160	160	1	3140	5000	2800	16	7.042 €
Carport SL 170 / 240	240	1	3140	5000	2800	16	8.802 €
Carport SL 170 / 100	100	1	3140	5500	2800	17	7.192 €
Carport SL 170 / 160	160	1	3140	5500	2800	17	7.746 €
Carport SL 170 / 240	240	1	3140	5500	2800	17	9.682 €
Carport SL 170 / 100	100	1	3140	6000	2800	19	7.473 €
Carport SL 170 / 160	160	1	3140	6000	2800	19	8.048 €
Carport SL 170 / 240	240	1	3140	6000	2800	19	10.060 €
Carport SL 170 / 100	100	1	3140	6500	2800	20	8.070 €
Carport SL 170 / 160	160	1	3140	6500	2800	20	8.661 €
Carport SL 170 / 240	240	1	3140	6500	2800	20	10.826 €
Carport SL 170 / 100	100	1	3140	7000	2800	22	8.479 €
Carport SL 170 / 160	160	1	3140	7000	2800	22	9.103 €
Carport SL 170 / 240	240	1	3140	7000	2800	22	11.378 €
Carport SL 170 / 100	100	1	3140	7500	2800	24	8.766 €
Carport SL 170 / 160	160	1	3140	7500	2800	24	9.413 €
Carport SL 170 / 240	240	1	3140	7500	2800	24	11.766 €
Carport SL 170 / 100	100	1	3140	8000	2800	25	9.119 €
Carport SL 170 / 160	160	1	3140	8000	2800	25	9.793 €
Carport SL 170 / 240	240	1	3140	8000	2800	25	12.242 €

Number of posts depend on the selected type of Carport. Four posts with robuseter external foot mounting are included in price. Every additional post is charged according to the price list on page 38.

	Infill	Width [mm]	Length [mm]	Max Height [mm]	Area [m ²]	Price €/pc
BOX / ISO 3	Insulated panel 3 cm**	3150	1200	2800	3,8	3.725 €
BOX / ISO 3		3150	1800	2800	5,7	4.156 €
BOX / ISO 3		3150	2400	2800	7,6	4.587 €
BOX / ISO 3		3150	3000	2800	9,5	5.018 €
BOX / WOOD	Siberian larch wood slats 24/70	3150	1200	2800	3,8	4.419 €
BOX / WOOD		3150	1800	2800	5,7	4.946 €
BOX / WOOD		3150	2400	2800	7,6	5.473 €
BOX / WOOD		3150	3000	2800	9,5	6.000 €
BOX / L44 - ES	Aluminium Expanded Metal Sheet*	3150	1200	2800	3,8	8.934 €
BOX / L44 - ES		3150	1800	2800	5,7	10.083 €
BOX / L44 - ES		3150	2400	2800	7,6	11.233 €
BOX / L44 - ES		3150	3000	2800	9,5	12.383 €
BOX / L44 - ALU 20 / 20	Aluminium square profile 20/20*	3150	1200	2800	3,8	10.323 €
BOX / L44 - ALU 20 / 20		3150	1800	2800	5,7	11.664 €
BOX / L44 - ALU 20 / 20		3150	2400	2800	7,6	13.005 €
BOX / L44 - ALU 20 / 20		3150	3000	2800	9,5	14.347 €

One door with a lock is included in price of the Box.

* Colour for STRUCTURE (profile, posts, secondary beam profile) and Box Infill (Aluminium Expanded Metal Sheet, Aluminum square profil 20/20).

** Colour for Insulated panel 3 cm (ROOF / BOX & WALL PANELS).

Carport structure is designed using the Eurocode standards. It is assembled according to EN 1090 standard. The prescribed maximal loads are calculated for three different scenarios, for maximal combined load of 100, 160 and 240 kg/m². These loads are already multiplied by safety factors and include wind and snow loads.

Limit loads and special requirements:

The bearing structure is designed for the utilization of the profiles material up to 80% under the prescribed maximal loads. The displacements of the structure (under self load) are limited to 1/500 x W, where W is the width of the Carport (Length of the secondary beam profile). Under full combination of snow and wind load the displacements are limited to 1/80 x W. The absolute displacements at the maximal loads and maximal span can reach 7 cm at span 6 m at the maximal loads. In the fully loaded condition with wind and snow it is advisable to remove the snow when the snow reaches a characteristic load of 75 kg / 125 kg / 180 kg according to the Eurocodes ((first/second/third scenario). Even though the bearing capacity is higher, in this way the structure remains in a aesthetically pleasant shape. Special attention is necessary with choosing the right variant of the Carport. For different countries and different locations, different maximal prescribed loads are defined by the Eurocodes. It is necessary to choose the Carport variant, which is sufficient for the location and layout for which it is meant for. In different European countries there are different laws and regulations regarding Carport structures. It is possible, that the user has to acquire a building permit for the Carport structure. The building permit documentation and foundation of the Carport is the responsibility of the user. It is suggested to use a 25 cm thick concrete foundation plate for the cars and foundation of the carport.

Prices are defined and expressed in EUR. The prices are always before VAT. Any discounts shall be agreed upon in written form. The prices are ex-works Soltec headquarters. Packaging excluded.

1
car

Technical details

Soltec **Carport +** Back Box SL 170

Right Box 240/2 Left Box 170/1 Back Box 240/2 Back Box 170/1

Roof cover	Insulated panels 3 cm
Frame	170/120
Secondary beam profile	80/50
Post	120/120
Width	3140 mm
Box dimensions	3.14 m x 1.2 m to 3.14 m x 3 m (3.8 m ² - 9.4 m ²)
Max Length on 3 posts (max distance between posts 4,7 m)	8000 mm
Foot type (optional: painting or stainless steel)	External 120 - galvanized
N° of water exits	2
Max snow load - secondary beam on every 1200 mm	100* kg / m ²
Max snow load - secondary beam on every 600 mm	160* kg / m ²
Max snow load - secondary beam on every 300 mm	240* kg / m ²

PROFILE 17

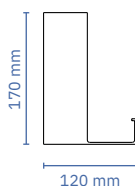

POSTS

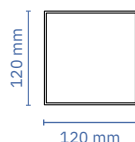

SECONDARY BEAM PROFILE

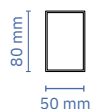

ROOF

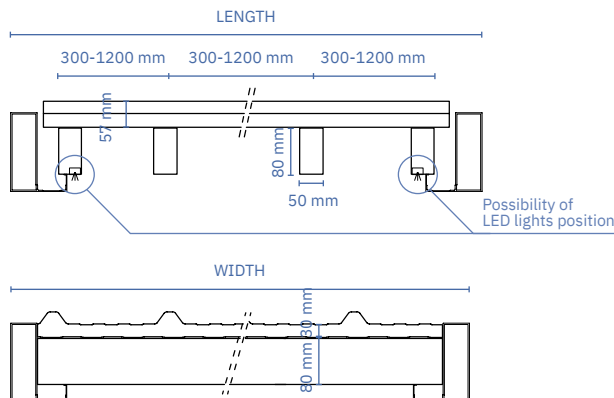

8x3m

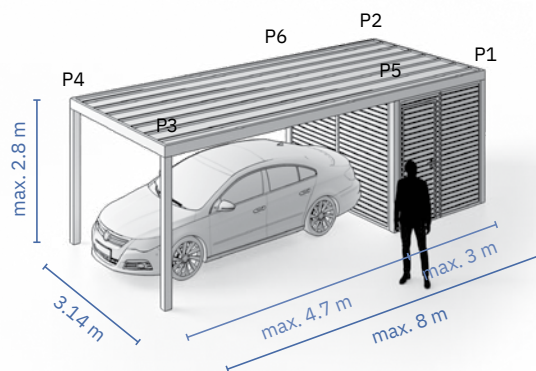

The image is symbolic and applies to all types. For max. dimensions for each type see Order form.

ROOF INCLINATION

Roof has 2% drop due to water runoff towards the water exits. Resulting in poles of different heights.

WATER EXITS

Water exits are on P1 and P2.

HIGH CORROSION RESISTANCE

Frame parts are made exclusively of aluminium and stainless steel.

* Carport structure is designed using the Eurocode standards. It is assembled according to EN 1090 standard. The prescribed maximal loads are calculated for three different scenarios, for maximal combined load of 100, 160 and 240 kg/m². These loads are already multiplied by safety factors and include wind and snow loads.

INOX
STAINLESS
STEEL



1
car

Price list

Soltec Carport + Left Box SL 170

	Snow load [kg/m ²]	Number of cars	Max Width [mm]	Max Length [mm]	Max Height [mm]	Max Area [m ²]	Price €/pc
Carport SL 170 / 100	100	1	6000	5000	2800	30	9.220 €
Carport SL 170 / 160	160	1	6000	5000	2800	30	10.210 €
Carport SL 170 / 240	240	1	6000	5000	2800	30	13.115 €
Carport SL 170 / 100	100	1	6000	5500	2800	33	10.141 €
Carport SL 170 / 160	160	1	6000	5500	2800	33	11.231 €
Carport SL 170 / 240	240	1	6000	5500	2800	33	14.426 €
Carport SL 170 / 100	100	1	6000	6000	2800	36	10.537 €
Carport SL 170 / 160	160	1	6000	6000	2800	36	11.669 €
Carport SL 170 / 240	240	1	6000	6000	2800	36	14.988 €
Carport SL 170 / 100	100	1	6000	6500	2800	39	11.379 €
Carport SL 170 / 160	160	1	6000	6500	2800	39	12.558 €
Carport SL 170 / 240	240	1	6000	6500	2800	39	16.131 €
Carport SL 170 / 100	100	1	6000	7000	2800	42	11.955 €
Carport SL 170 / 160	160	1	6000	7000	2800	42	13.199 €
Carport SL 170 / 240	240	1	6000	7000	2800	42	16.954 €
Carport SL 170 / 100	100	1	6000	7500	2800	45	12.360 €
Carport SL 170 / 160	160	1	6000	7500	2800	45	13.648 €
Carport SL 170 / 240	240	1	6000	7500	2800	45	17.531 €
Carport SL 170 / 100	100	1	6000	8000	2800	48	12.857 €
Carport SL 170 / 160	160	1	6000	8000	2800	48	14.200 €
Carport SL 170 / 240	240	1	6000	8000	2800	48	18.240 €

Number of posts depend on the selected type of Carport. Four posts with robuseter external foot mounting are included in price. Every additional post is charged according to the price list on page 38.

	Infill	Width [mm]	Max Length [mm]	Max Height [mm]	Max Area [m ²]	Price €/pc
BOX / ISO 3	Insulated panel 3 cm**	1200	8000	2800	9,6	7.877 €
BOX / ISO 3		1800	8000	2800	14,4	8.227 €
BOX / ISO 3		2400	8000	2800	19,2	8.595 €
BOX / ISO 3		3000	8000	2800	24,0	8.975 €
BOX / WOOD	Siberian larch wood slats 24/70	1200	8000	2800	9,6	9.346 €
BOX / WOOD		1800	8000	2800	14,4	9.792 €
BOX / WOOD		2400	8000	2800	19,2	10.255 €
BOX / WOOD		3000	8000	2800	24,0	10.731 €
BOX / L44 - ES	Aluminium Expanded Metal Sheet*	1200	8000	2800	9,6	18.894 €
BOX / L44 - ES		1800	8000	2800	14,4	19.963 €
BOX / L44 - ES		2400	8000	2800	19,2	21.049 €
BOX / L44 - ES		3000	8000	2800	24,0	22.148 €
BOX / L44 - ALU 20 / 20	Aluminium square profile 20/20*	1200	8000	2800	9,6	21.832 €
BOX / L44 - ALU 20 / 20		1800	8000	2800	14,4	23.092 €
BOX / L44 - ALU 20 / 20		2400	8000	2800	19,2	24.370 €
BOX / L44 - ALU 20 / 20		3000	8000	2800	24,0	25.660 €

One door with a lock is included in price of the Box.

* Colour for STRUCTURE (profile, posts, secondary beam profile) and Box Infill (Aluminium Expanded Metal Sheet, Aluminum square profil 20/20).

** Colour for Insulated panel 3 cm (ROOF / BOX & WALL PANELS).

Carport structure is designed using the Eurocode standards. It is assembled according to EN 1090 standard. The prescribed maximal loads are calculated for three different scenarios, for maximal combined load of 100, 160 and 240 kg/m². These loads are already multiplied by safety factors and include wind and snow loads.

Limit loads and special requirements:

The bearing structure is designed for the utilization of the profiles material up to 80% under the prescribed maximal loads. The displacements of the structure (under self load) are limited to 1/500 x W, where W is the width of the Carport (Length of the secondary beam profile). Under full combination of snow and wind load the displacements are limited to 1/80 x W. The absolute displacements at the maximal loads and maximal span can reach 7 cm at span 6 m at the maximal loads. In the fully loaded condition with wind and snow it is advisable to remove the snow when the snow reaches a characteristic load of 75 kg / 125 kg / 180 kg according to the Eurocodes (first/second/third scenario). Even though the bearing capacity is higher, in this way the structure remains in a aesthetically pleasant shape. Special attention is necessary with choosing the right variant of the Carport. For different countries and different locations, different maximal prescribed loads are defined by the Eurocodes. It is necessary to choose the Carport variant, which is sufficient for the location and layout for which it is meant for. In different European countries there are different laws and regulations regarding Carport structures. It is possible, that the user has to acquire a building permit for the Carport structure. The building permit documentation and foundation of the Carport is the responsibility of the user. It is suggested to use a 25 cm thick concrete foundation plate for the cars and foundation of the carport.

Prices are defined and expressed in EUR. The prices are always before VAT. Any discounts shall be agreed upon in written form. The prices are ex-works Soltec headquarters. Packaging excluded.

1
car

Technical details

Soltec Carport + Left Box SL 170

Right Box 240/2 Left Box 240/2 Back Box 240/2 240/2 Right Box 170/1 Left Box 170/1 Back Box 170/1 170/1

Roof cover	Insulated panels 3 cm
Frame	170/120
Secondary beam profile	80/50 120/120
Post	120/120
Width	6000 mm
Box dimensions	L x 1.2 m to L x 3 m (up to 24 m ²)
Max Length on 3 posts (max distance between posts 4,7 m)	8000 mm
Foot type (optional: painting or stainless steel)	External 120 - galvanized
N° of water exits	3
Max snow load - secondary beam on every 1200 mm	100* kg / m ²
Max snow load - secondary beam on every 600 mm	160* kg / m ²
Max snow load - secondary beam on every 300 mm	240* kg / m ²

PROFILE 17

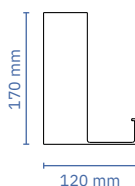

POSTS

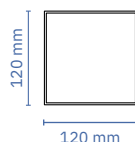

SECONDARY BEAM PROFILE

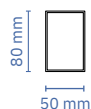

ROOF

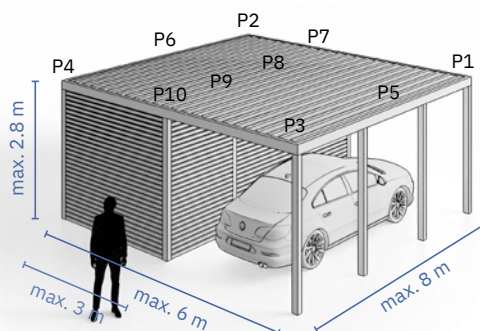
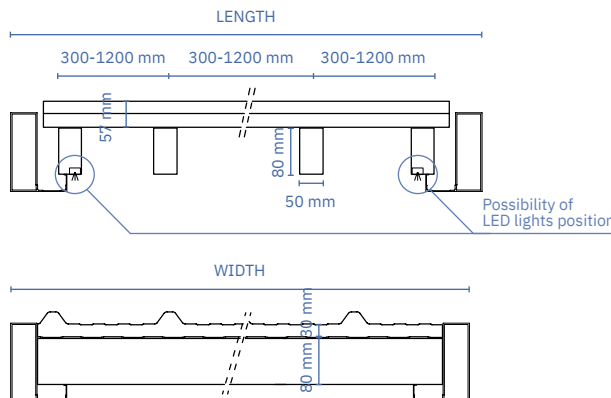

The image is symbolic and applies to all types. For max. dimensions for each type see Order form.

ROOF INCLINATION

Roof has 2% drop due to water runoff towards the water exits. Resulting in poles of different heights.

WATER EXITS

Water exits are on P1, P2 and P7.

HIGH CORROSION RESISTANCE

Frame parts are made exclusively of aluminium and stainless steel.

* Carport structure is designed using the Eurocode standards. It is assembled according to EN 1090 standard. The prescribed maximal loads are calculated for three different scenarios, for maximal combined load of 100, 160 and 240 kg/m². These loads are already multiplied by safety factors and include wind and snow loads.



1
car

Price list

Soltec Carport + Right Box SL 170

	Snow load [kg/m ²]	Number of cars	Max Width [mm]	Max Length [mm]	Max Height [mm]	Max Area [m ²]	Price €/pc
Carport SL 170 / 100	100	1	6000	5000	2800	30	9.220 €
Carport SL 170 / 160	160	1	6000	5000	2800	30	10.210 €
Carport SL 170 / 240	240	1	6000	5000	2800	30	13.115 €
Carport SL 170 / 100	100	1	6000	5500	2800	33	10.141 €
Carport SL 170 / 160	160	1	6000	5500	2800	33	11.231 €
Carport SL 170 / 240	240	1	6000	5500	2800	33	14.426 €
Carport SL 170 / 100	100	1	6000	6000	2800	36	10.537 €
Carport SL 170 / 160	160	1	6000	6000	2800	36	11.669 €
Carport SL 170 / 240	240	1	6000	6000	2800	36	14.988 €
Carport SL 170 / 100	100	1	6000	6500	2800	39	11.379 €
Carport SL 170 / 160	160	1	6000	6500	2800	39	12.558 €
Carport SL 170 / 240	240	1	6000	6500	2800	39	16.131 €
Carport SL 170 / 100	100	1	6000	7000	2800	42	11.955 €
Carport SL 170 / 160	160	1	6000	7000	2800	42	13.199 €
Carport SL 170 / 240	240	1	6000	7000	2800	42	16.954 €
Carport SL 170 / 100	100	1	6000	7500	2800	45	12.360 €
Carport SL 170 / 160	160	1	6000	7500	2800	45	13.648 €
Carport SL 170 / 240	240	1	6000	7500	2800	45	17.531 €
Carport SL 170 / 100	100	1	6000	8000	2800	48	12.857 €
Carport SL 170 / 160	160	1	6000	8000	2800	48	14.200 €
Carport SL 170 / 240	240	1	6000	8000	2800	48	18.240 €

Number of posts depend on the selected type of Carport. Four posts with robuseter external foot mounting are included in price. Every additional post is charged according to the price list on page 38.

	Infill	Width [mm]	Max Length [mm]	Max Height [mm]	Max Area [m ²]	Price €/pc
BOX / ISO 3	Insulated panel 3 cm**	1200	8000	2800	9,6	7.877 €
BOX / ISO 3		1800	8000	2800	14,4	8.227 €
BOX / ISO 3		2400	8000	2800	19,2	8.595 €
BOX / ISO 3		3000	8000	2800	24,0	8.975 €
BOX / WOOD	Siberian larch wood slats 24/70	1200	8000	2800	9,6	9.346 €
BOX / WOOD		1800	8000	2800	14,4	9.792 €
BOX / WOOD		2400	8000	2800	19,2	10.255 €
BOX / WOOD		3000	8000	2800	24,0	10.731 €
BOX / L44 - ES	Aluminium Expanded Metal Sheet*	1200	8000	2800	9,6	18.894 €
BOX / L44 - ES		1800	8000	2800	14,4	19.963 €
BOX / L44 - ES		2400	8000	2800	19,2	21.049 €
BOX / L44 - ES		3000	8000	2800	24,0	22.148 €
BOX / L44 - ALU 20 / 20	Aluminium square profile 20/20*	1200	8000	2800	9,6	21.832 €
BOX / L44 - ALU 20 / 20		1800	8000	2800	14,4	23.092 €
BOX / L44 - ALU 20 / 20		2400	8000	2800	19,2	24.370 €
BOX / L44 - ALU 20 / 20		3000	8000	2800	24,0	25.660 €

One door with a lock is included in price of the Box.

* Colour for STRUCTURE (profile, posts, secondary beam profile) and Box Infill (Aluminium Expanded Metal Sheet, Aluminum square profil 20/20).

** Colour for Insulated panel 3 cm (ROOF / BOX & WALL PANELS).

Carport structure is designed using the Eurocode standards. It is assembled according to EN 1090 standard. The prescribed maximal loads are calculated for three different scenarios, for maximal combined load of 100, 160 and 240 kg/m². These loads are already multiplied by safety factors and include wind and snow loads.

Limit loads and special requirements:

The bearing structure is designed for the utilization of the profiles material up to 80% under the prescribed maximal loads. The displacements of the structure (under self load) are limited to 1/500 x W, where W is the width of the Carport (Length of the secondary beam profile). Under full combination of snow and wind load the displacements are limited to 1/80 x W. The absolute displacements at the maximal loads and maximal span can reach 7 cm at span 6 m at the maximal loads. In the fully loaded condition with wind and snow it is advisable to remove the snow when the snow reaches a characteristic load of 75 kg / 125 kg / 180 kg according to the Eurocodes (first/second/third scenario). Even though the bearing capacity is higher, in this way the structure remains in a aesthetically pleasant shape. Special attention is necessary with choosing the right variant of the Carport. For different countries and different locations, different maximal prescribed loads are defined by the Eurocodes. It is necessary to choose the Carport variant, which is sufficient for the location and layout for which it is meant for. In different European countries there are different laws and regulations regarding Carport structures. It is possible, that the user has to acquire a building permit for the Carport structure. The building permit documentation and foundation of the Carport is the responsibility of the user. It is suggested to use a 25 cm thick concrete foundation plate for the cars and foundation of the carport.

Prices are defined and expressed in EUR. The prices are always before VAT. Any discounts shall be agreed upon in written form. The prices are ex-works Soltec headquarters. Packaging excluded.

1
car

Technical details

Soltec Carport + Right Box SL 170

Right Box 240/2 Left Box 240/2 Back Box 240/2 Right Box 170/1 Left Box 170/1 Back Box 170/1 170/1

Roof cover	Insulated panels 3 cm
Frame	170/120
Secondary beam profile	80/50 120/120
Post	120/120
Width	6000 mm
Box dimensions	L x 1,2 m - L x 3 m (up to 24 m ²)
Max Length on 3 posts (max distance between posts 4,7 m)	8000 mm
Foot type (optional: painting or stainless steel)	External 120 - galvanized
N° of water exits	3
Max snow load - secondary beam on every 1200 mm	100* kg / m ²
Max snow load - secondary beam on every 600 mm	160* kg / m ²
Max snow load - secondary beam on every 300 mm	240* kg / m ²

PROFILE 17

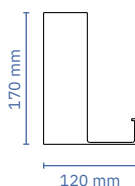

POSTS

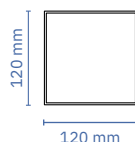

SECONDARY BEAM PROFILE

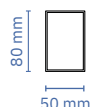

ROOF

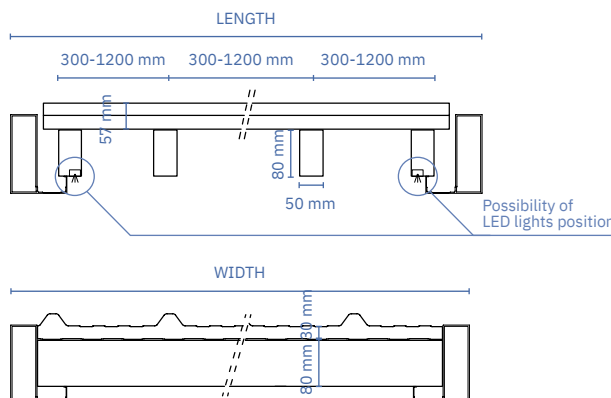

8x6m

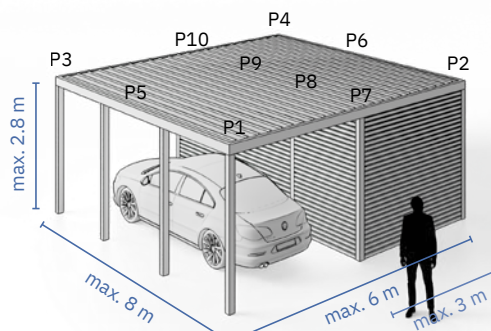

The image is symbolic and applies to all types.
For max. dimensions for each type see Order form.

ROOF INCLINATION

Roof has 2% drop due to water runoff towards the water exits.
Resulting in poles of different heights.

WATER EXITS

Water exits are on P1, P2 and P7.

HIGH CORROSION RESISTANCE

Frame parts are made exclusively of aluminium and stainless steel.

* Carport structure is designed using the Eurocode standards. It is assembled according to EN 1090 standard. The prescribed maximal loads are calculated for three different scenarios, for maximal combined load of 100, 160 and 240 kg/m². These loads are already multiplied by safety factors and include wind and snow loads.

INOX
STAINLESS
STEEL



1 car

Types of installations Soltec **Carport** SL 170

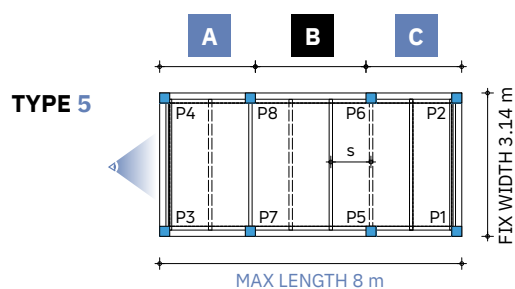
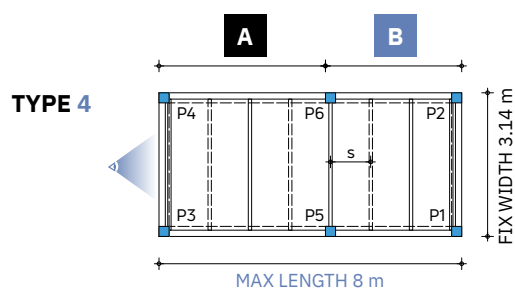
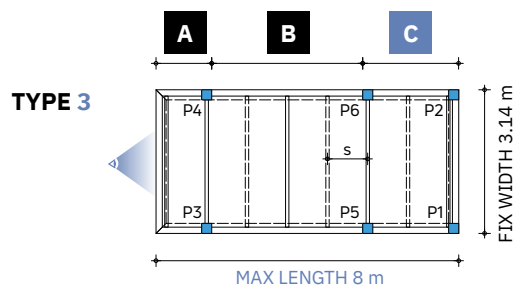
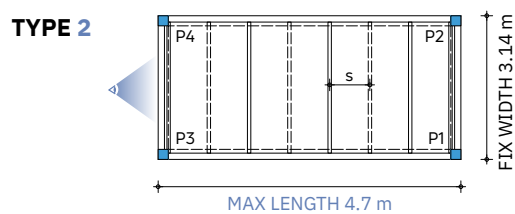
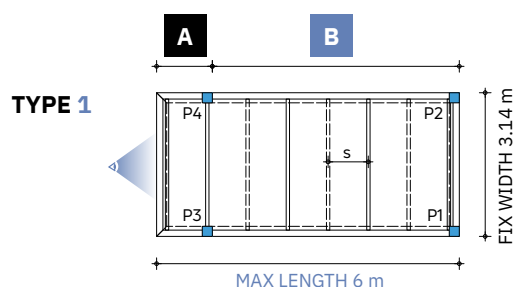

- Secondary beams, for load capacity:
 - 100 kg/m²: $s_{\max} = 1,2$ m,
 - 160 kg/m²: $s_{\max} = 0,6$ m,
 - 240 kg/m²: $s_{\max} = 0,3$ m, post distance max. 3 m
- Additional secondary beams for a higher load capacity
- Post position
- Walls

Load capacity [kg/m ²]	100	160	240
s max distance between secondary beams [mm]	1200	600	300

The maximum dimensions depend on the load capacity and selected type. For details look at the order form.

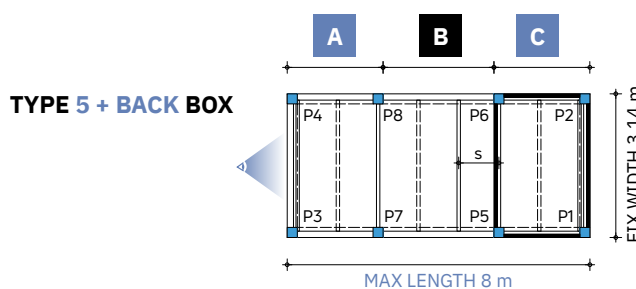
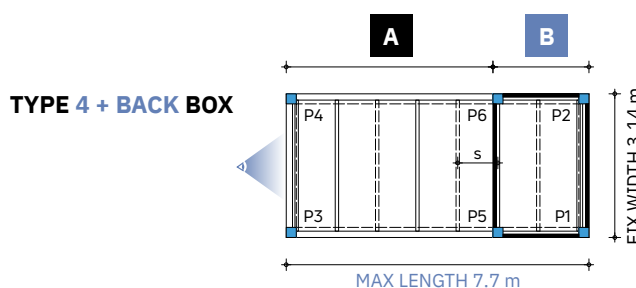
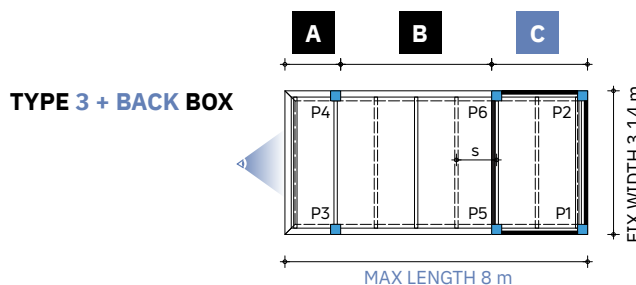

1
car

Types of installations

Soltec Carport

SL 170

- Secondary beams, for load capacity:
 - 100 kg/m²: $s_{max} = 1,2$ m, post distance max. 3 m
 - 160 kg/m²: $s_{max} = 0,6$ m, post distance max. 3 m
 - 240 kg/m²: $s_{max} = 0,3$ m, post distance max. 3 m
- Additional secondary beams for a higher load capacity
- Post position
- Walls

Load capacity [kg/m ²]	100	160	240
s max distance between secondary beams [mm]	1200	600	300

The maximum dimensions depend on the load capacity and selected type. For details look at the order form.

TYPE 5 + LEFT BOX

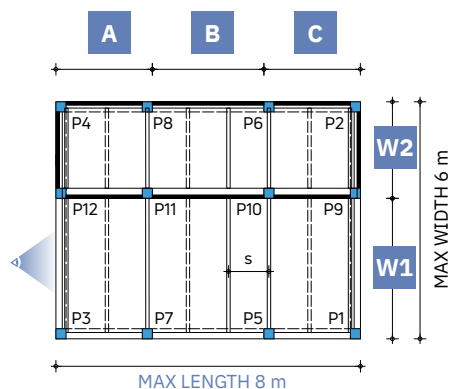

TYPE 5 + RIGHT BOX

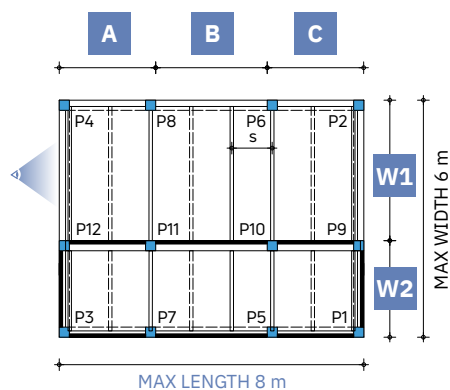

2
cars

Price list

Soltec Carport

SL 240

	Snow load [kg/m ²]	Number of cars	Max Width [mm]	Max Length [mm]	Max Height [mm]	Max Area [m ²]	Price €/pc
Carport SL 240 / 100	100	2	6000	5000	2800	30	13.931 €
Carport SL 240 / 160	160	2	6000	5000	2800	30	16.679 €
Carport SL 240 / 240	240	2	6000	5000	2800	30	19.348 €
Carport SL 240 / 100	100	2	6000	5500	2800	33	15.325 €
Carport SL 240 / 160	160	2	6000	5500	2800	33	18.346 €
Carport SL 240 / 240	240	2	6000	5500	2800	33	21.282 €
Carport SL 240 / 100	100	2	6000	6000	2800	36	15.922 €
Carport SL 240 / 160	160	2	6000	6000	2800	36	19.061 €
Carport SL 240 / 240	240	2	6000	6000	2800	36	22.110 €
Carport SL 240 / 100	100	2	6000	6500	2800	39	16.764 €
Carport SL 240 / 160	160	2	6000	6500	2800	39	19.996 €
Carport SL 240 / 240	240	2	6000	6500	2800	39	23.195 €
Carport SL 240 / 100	100	2	6000	7000	2800	42	17.646 €
Carport SL 240 / 160	160	2	6000	7000	2800	42	21.053 €
Carport SL 240 / 240	240	2	6000	7000	2800	42	24.421 €
Carport SL 240 / 100	100	2	6000	7500	2800	45	18.270 €
Carport SL 240 / 160	160	2	6000	7500	2800	45	21.803 €
Carport SL 240 / 240	240	2	6000	7500	2800	45	25.291 €
Carport SL 240 / 100	100	2	6000	8000	2800	48	19.033 €
Carport SL 240 / 160	160	2	6000	8000	2800	48	22.716 €
Carport SL 240 / 240	240	2	6000	8000	2800	48	26.521 €
Carport SL 240 / 100	100	2	6000	8500	2800	51	19.958 €
Carport SL 240 / 160	160	2	6000	8500	2800	51	23.759 €
Carport SL 240 / 240	240	2	6000	8500	2800	51	27.838 €

Number of posts depend on the selected type of Carport. Four posts with robust external foot mounting are included in price. Every additional post is charged according to the price list on page 38.

Carport structure is designed using the Eurocode standards. It is assembled according to EN 1090 standard. The prescribed maximal loads are calculated for three different scenarios, for maximal combined load of 100, 160 and 240 kg/m². These loads are already multiplied by safety factors and include wind and snow loads.

Limit loads and special requirements:

The bearing structure is designed for the utilization of the profiles material up to 80% under the prescribed maximal loads. The displacements of the structure (under self load) are limited to $1/500 \times W$, where W is the width of the Carport (Length of the secondary beam profile). Under full combination of snow and wind load the displacements are limited to $1/80 \times W$. The absolute displacements at the maximal loads and maximal span can reach 7 cm at span 6 m at the maximal loads. In the fully loaded condition with wind and snow it is advisable to remove the snow when the snow reaches a characteristic load of 75 kg / 125 kg / 180 kg according to the Eurocodes (first/second/third scenario). Even though the bearing capacity is higher, in this way the structure remains in a aesthetically pleasant shape. Special attention is necessary with choosing the right variant of the Carport. For different countries and different locations, different maximal prescribed loads are defined by the Eurocodes. It is necessary to choose the Carport variant, which is sufficient for the location and layout for which it is meant for. In different European countries there are different laws and regulations regarding Carport structures. It is possible, that the user has to acquire a building permit for the Carport structure. The building permit documentation and foundation of the Carport is the responsibility of the user. It is suggested to use a 25 cm thick concrete foundation plate for the cars and foundation of the carport.

Prices are defined and expressed in EUR. The prices are always before VAT. Any discounts shall be agreed upon in written form. The prices are ex-works Soltec headquarters. Packaging excluded.

2
cars

Technical details

Soltec Carport

SL 240

Roof cover	Insulated panels 3 cm
Frame	240/150
Secondary beam profile	150/50
Post	150/150
Max width	6000 mm
Max Length on 2 posts (max distance between posts 4,7 m)	6000 mm (overhang 1,3 m)
Max Length on 3 posts (max distance between posts 4,7 m)	8500 mm
Foot type (optional: painting or stainless steel)	External 150 - galvanized
N° of water exits	2
Max snow load - secondary beam on every 1200 mm	100* kg / m ²
Max snow load - secondary beam on every 600 mm	160* kg / m ²
Max snow load - secondary beam on every 300 mm	240* kg / m ²

PROFILE 24

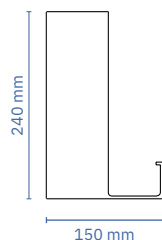

POSTS

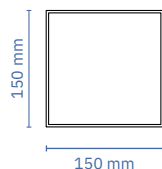

SECONDARY BEAM PROFILE

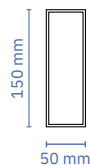

ROOF

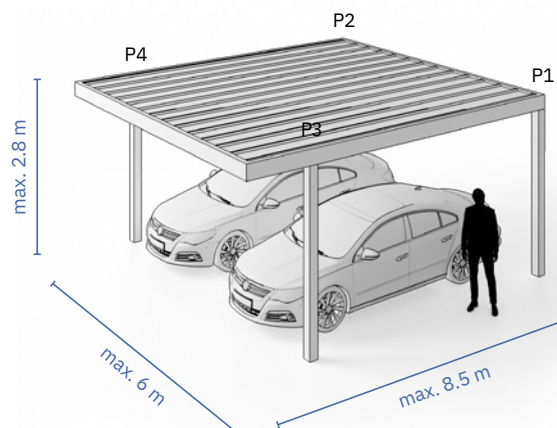
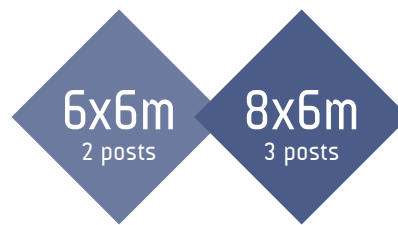
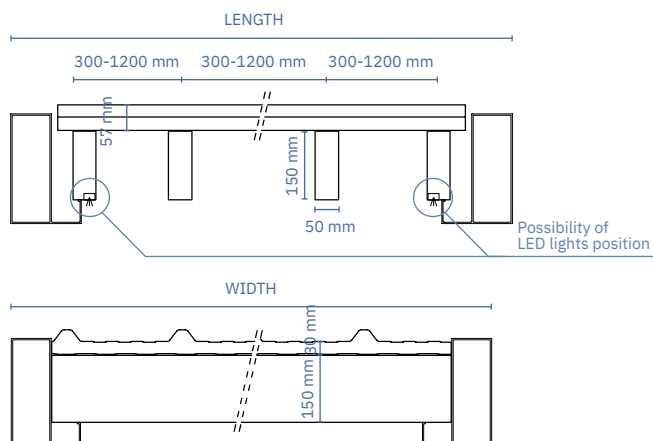

The image is symbolic and applies to all types. For max. dimensions for each type see Order form.

ROOF INCLINATION

Roof has 2% drop due to water runoff towards the water exits. Resulting in poles of different heights.

WATER EXITS

Water exits are on P1 and P2.

HIGH CORROSION RESISTANCE

Frame parts are made exclusively of aluminium and stainless steel.

* Carport structure is designed using the Eurocode standards. It is assembled according to EN 1090 standard. The prescribed maximal loads are calculated for three different scenarios, for maximal combined load of 100, 160 and 240 kg/m². These loads are already multiplied by safety factors and include wind and snow loads.





Price list

Soltec Carport + Back Box SL 240

	Snow load [kg/m ²]	Number of cars	Max Width [mm]	Max Length [mm]	Max Height [mm]	Max Area [m ²]	Price €/pc
Carport SL 240 / 100	100	2	6000	5000	2800	30	13.931 €
Carport SL 240 / 160	160	2	6000	5000	2800	30	16.679 €
Carport SL 240 / 240	240	2	6000	5000	2800	30	19.348 €
Carport SL 240 / 100	100	2	6000	5500	2800	33	15.325 €
Carport SL 240 / 160	160	2	6000	5500	2800	33	18.346 €
Carport SL 240 / 240	240	2	6000	5500	2800	33	21.282 €
Carport SL 240 / 100	100	2	6000	6000	2800	36	15.922 €
Carport SL 240 / 160	160	2	6000	6000	2800	36	19.061 €
Carport SL 240 / 240	240	2	6000	6000	2800	36	22.110 €
Carport SL 240 / 100	100	2	6000	6500	2800	39	16.764 €
Carport SL 240 / 160	160	2	6000	6500	2800	39	19.996 €
Carport SL 240 / 240	240	2	6000	6500	2800	39	23.195 €
Carport SL 240 / 100	100	2	6000	7000	2800	42	17.646 €
Carport SL 240 / 160	160	2	6000	7000	2800	42	21.053 €
Carport SL 240 / 240	240	2	6000	7000	2800	42	24.421 €
Carport SL 240 / 100	100	2	6000	7500	2800	45	18.270 €
Carport SL 240 / 160	160	2	6000	7500	2800	45	21.803 €
Carport SL 240 / 240	240	2	6000	7500	2800	45	25.291 €
Carport SL 240 / 100	100	2	6000	8000	2800	48	19.033 €
Carport SL 240 / 160	160	2	6000	8000	2800	48	22.716 €
Carport SL 240 / 240	240	2	6000	8000	2800	48	26.521 €
Carport SL 240 / 100	100	2	6000	8500	2800	51	19.958 €
Carport SL 240 / 160	160	2	6000	8500	2800	51	23.759 €
Carport SL 240 / 240	240	2	6000	8500	2800	51	27.838 €

Number of posts depend on the selected type of Carport. Four posts with robust external foot mounting are included in price. Every additional post is charged according to the price list on page 38.

	Infill	Max Width [mm]	Length [mm]	Max Height [mm]	Max Area [m ²]	Price €/pc
BOX / ISO 3	Insulated panel 3 cm**	6000	1200	2800	7,2	5.772 €
BOX / ISO 3		6000	1800	2800	10,8	6.204 €
BOX / ISO 3		6000	2400	2800	14,4	6.635 €
BOX / ISO 3		6000	3000	2800	18,0	7.066 €
BOX / WOOD	Siberian larch wood slats 24/70	6000	1200	2800	7,2	6.922 €
BOX / WOOD		6000	1800	2800	10,8	7.449 €
BOX / WOOD		6000	2400	2800	14,4	7.976 €
BOX / WOOD		6000	3000	2800	18,0	8.503 €
BOX / L44 - ES	Aluminium Expanded Metal Sheet*	6000	1200	2800	7,2	14.394 €
BOX / L44 - ES		6000	1800	2800	10,8	15.544 €
BOX / L44 - ES		6000	2400	2800	14,4	16.694 €
BOX / L44 - ES		6000	3000	2800	18,0	17.843 €
BOX / L44 - ALU 20 / 20	Aluminium square profile 20/20*	6000	1200	2800	7,2	16.694 €
BOX / L44 - ALU 20 / 20		6000	1800	2800	10,8	18.035 €
BOX / L44 - ALU 20 / 20		6000	2400	2800	14,4	19.376 €
BOX / L44 - ALU 20 / 20		6000	3000	2800	18,0	20.717 €

One door with a lock is included in price of the Box.

* Colour for STRUCTURE (profile, posts, secondary beam profile) and Box Infill (Aluminium Expanded Metal Sheet, Aluminum square profil 20/20).

** Colour for Insulated panel 3 cm (ROOF / BOX & WALL PANELS).

Carport structure is designed using the Eurocode standards. It is assembled according to EN 1090 standard. The prescribed maximal loads are calculated for three different scenarios, for maximal combined load of 100, 160 and 240 kg/m². These loads are already multiplied by safety factors and include wind and snow loads.

Limit loads and special requirements:

The bearing structure is designed for the utilization of the profiles material up to 80% under the prescribed maximal loads. The displacements of the structure (under self load) are limited to 1/500 x W, where W is the width of the Carport (Length of the secondary beam profile). Under full combination of snow and wind load the displacements are limited to 1/80 x W. The absolute displacements at the maximal loads and maximal span can reach 7 cm at span 6 m at the maximal loads. In the fully loaded condition with wind and snow it is advisable to remove the snow when the snow reaches a characteristic load of 75 kg / 125 kg / 180 kg according to the Eurocodes (first/second/third scenario). Even though the bearing capacity is higher, in this way the structure remains in a aesthetically pleasant shape. Special attention is necessary with choosing the right variant of the Carport. For different countries and different locations, different maximal prescribed loads are defined by the Eurocodes. It is necessary to choose the Carport variant, which is sufficient for the location and layout for which it is meant for. In different European countries there are different laws and regulations regarding Carport structures. It is possible, that the user has to acquire a building permit for the Carport structure. The building permit documentation and foundation of the Carport is the responsibility of the user. It is suggested to use a 25 cm thick concrete foundation plate for the cars and foundation of the carport.

Prices are defined and expressed in EUR. The prices are always before VAT. Any discounts shall be agreed upon in written form. The prices are ex-works Soltec headquarters. Packaging excluded.

2
cars

Technical details

Soltec Carport + Back Box SL 240

Right Box 240/2 Left Box 240/2 Back Box 240/2 240/2 Right Box 170/1 Left Box 170/1 Back Box 170/1 170/1

Roof cover	Insulated panels 3 cm
Frame	240/150
Secondary beam profile	150/50
Post	150/150
Max width	6000 mm
Box dimensions	W x 1.2 m - W x 3 m (up to 18 m ²)
Max Length on 3 posts (max distance between posts 4,7 m)	8500 mm
Foot type (optional: painting or stainless steel)	External 150 - galvanized
N° of water exits	2
Max snow load - secondary beam on every 1200 mm	100* kg / m ²
Max snow load - secondary beam on every 600 mm	160* kg / m ²
Max snow load - secondary beam on every 300 mm	240* kg / m ²

PROFILE 24

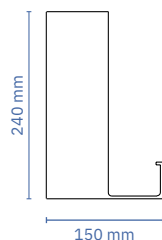

POSTS

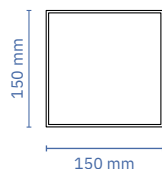

SECONDARY BEAM PROFILE

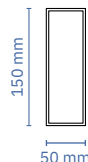

ROOF

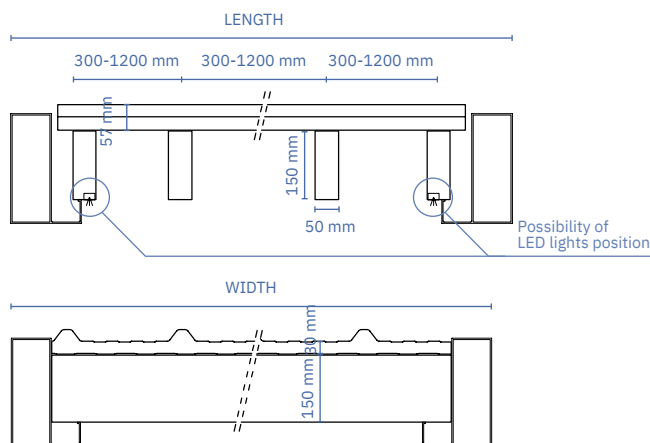

ROOF INCLINATION

Roof has 2% drop due to water runoff towards the water exits. Resulting in poles of different heights.

WATER EXITS

Water exits are on P1 and P2.

HIGH CORROSION RESISTANCE

Frame parts are made exclusively of aluminium and stainless steel.

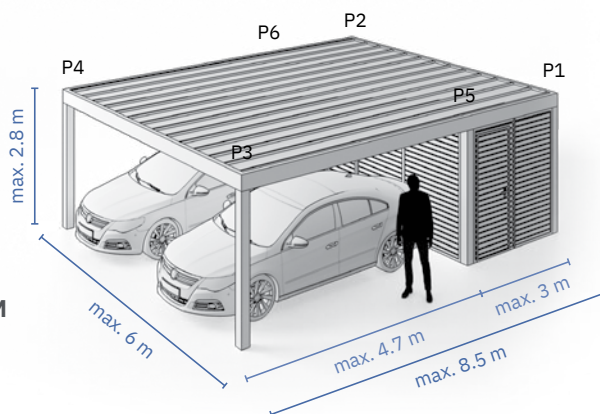

The image is symbolic and applies to all types. For max. dimensions for each type see Order form.

* Carport structure is designed using the Eurocode standards. It is assembled according to EN 1090 standard. The prescribed maximal loads are calculated for three different scenarios, for maximal combined load of 100, 160 and 240 kg/m². These loads are already multiplied by safety factors and include wind and snow loads.



Price list

Soltec Carport + Left Box SL 240

	Snow load [kg/m ²]	Number of cars	Max Width [mm]	Max Length [mm]	Max Height [mm]	Max Area [m ²]	Price €/pc
Carport SL 240 / 100	100	2	8500	5000	2800	43	13.931 €
Carport SL 240 / 160	160	2	8500	5000	2800	43	16.679 €
Carport SL 240 / 240	240	2	8500	5000	2800	43	19.681 €
Carport SL 240 / 100	100	2	8500	5500	2800	47	15.325 €
Carport SL 240 / 160	160	2	8500	5500	2800	47	18.346 €
Carport SL 240 / 240	240	2	8500	5500	2800	47	21.648 €
Carport SL 240 / 100	100	2	8500	6000	2800	51	15.922 €
Carport SL 240 / 160	160	2	8500	6000	2800	51	19.061 €
Carport SL 240 / 240	240	2	8500	6000	2800	51	22.492 €
Carport SL 240 / 100	100	2	8500	6500	2800	55	16.764 €
Carport SL 240 / 160	160	2	8500	6500	2800	55	19.996 €
Carport SL 240 / 240	240	2	8500	6500	2800	55	23.595 €
Carport SL 240 / 100	100	2	8500	7000	2800	60	17.646 €
Carport SL 240 / 160	160	2	8500	7000	2800	60	21.053 €
Carport SL 240 / 240	240	2	8500	7000	2800	60	24.842 €
Carport SL 240 / 100	100	2	8500	7500	2800	64	18.270 €
Carport SL 240 / 160	160	2	8500	7500	2800	64	21.803 €
Carport SL 240 / 240	240	2	8500	7500	2800	64	25.728 €
Carport SL 240 / 100	100	2	8500	8000	2800	68	19.033 €
Carport SL 240 / 160	160	2	8500	8000	2800	68	22.716 €
Carport SL 240 / 240	240	2	8500	8000	2800	68	26.805 €
Carport SL 240 / 100	100	2	8500	8500	2800	72	19.827 €
Carport SL 240 / 160	160	2	8500	8500	2800	72	23.667 €
Carport SL 240 / 240	240	2	8500	8500	2800	72	27.927 €

Number of posts depend on the selected type of Carport. Four posts with robust external foot mounting are included in price. Every additional post is charged according to the price list on page 38.

	Infill	Width [mm]	Max Length [mm]	Max Height [mm]	Max Area [m ²]	Price €/pc
BOX / ISO 3	Insulated panel 3 cm**	1200	8500	2800	10,2	5.772 €
BOX / ISO 3		1800	8500	2800	15,3	6.204 €
BOX / ISO 3		2400	8500	2800	20,4	6.635 €
BOX / ISO 3		3000	8500	2800	25,5	7.066 €
BOX / WOOD	Siberian larch wood slats 24/70	1200	8500	2800	10,2	6.922 €
BOX / WOOD		1800	8500	2800	15,3	7.449 €
BOX / WOOD		2400	8500	2800	20,4	7.976 €
BOX / WOOD		3000	8500	2800	25,5	8.503 €
BOX / L44 - ES	Aluminium Expanded Metal Sheet*	1200	8500	2800	10,2	14.394 €
BOX / L44 - ES		1800	8500	2800	15,3	15.544 €
BOX / L44 - ES		2400	8500	2800	20,4	16.694 €
BOX / L44 - ES		3000	8500	2800	25,5	17.843 €
BOX / L44 - ALU 20 / 20	Aluminium square profile 20/20*	1200	8500	2800	10,2	16.694 €
BOX / L44 - ALU 20 / 20		1800	8500	2800	15,3	18.035 €
BOX / L44 - ALU 20 / 20		2400	8500	2800	20,4	19.376 €
BOX / L44 - ALU 20 / 20		3000	8500	2800	25,5	20.717 €

One door with a lock is included in price of the Box.

* Colour for STRUCTURE (profile, posts, secondary beam profile) and Box Infill (Aluminium Expanded Metal Sheet, Aluminum square profil 20/20).

** Colour for Insulated panel 3 cm (ROOF / BOX & WALL PANELS).

Carport structure is designed using the Eurocode standards. It is assembled according to EN 1090 standard. The prescribed maximal loads are calculated for three different scenarios, for maximal combined load of 100, 160 and 240 kg/m². These loads are already multiplied by safety factors and include wind and snow loads.

Limit loads and special requirements:

The bearing structure is designed for the utilization of the profiles material up to 80% under the prescribed maximal loads. The displacements of the structure (under self load) are limited to 1/500 x W, where W is the width of the Carport (Length of the secondary beam profile). Under full combination of snow and wind load the displacements are limited to 1/80 x W. The absolute displacements at the maximal loads and maximal span can reach 7 cm at span 6 m at the maximal loads. In the fully loaded condition with wind and snow it is advisable to remove the snow when the snow reaches a characteristic load of 75 kg / 125 kg / 180 kg according to the Eurocodes (first/second/third scenario). Even though the bearing capacity is higher, in this way the structure remains in a aesthetically pleasant shape. Special attention is necessary with choosing the right variant of the Carport. For different countries and different locations, different maximal prescribed loads are defined by the Eurocodes. It is necessary to choose the Carport variant, which is sufficient for the location and layout for which it is meant for. In different European countries there are different laws and regulations regarding Carport structures. It is possible, that the user has to acquire a building permit for the Carport structure. The building permit documentation and foundation of the Carport is the responsibility of the user. It is suggested to use a 25 cm thick concrete foundation plate for the cars and foundation of the carport.

Prices are defined and expressed in EUR. The prices are always before VAT. Any discounts shall be agreed upon in written form. The prices are ex-works Soltec headquarters. Packaging excluded.

2
cars

Technical details

Soltec Carport + Left Box SL 240

Right Box 240/2 Left Box 240/2 Back Box 240/2 Right Box 170/1 Left Box 170/1 Back Box 170/1 170/1

Roof cover	Insulated panels 3 cm
Frame	240/150
Secondary beam profile	150/50
Post	150/150
Max width	8500 mm
Box dimensions	L x 1.2 m - L x 3 m (up to 25.5 m ²)
Max Length on 3 posts (max distance between posts 4,7 m)	8500 mm
Foot type (optional: painting or stainless steel)	External 150 - galvanized
N° of water exits	3
Max snow load - secondary beam on every 1200 mm	100* kg / m ²
Max snow load - secondary beam on every 600 mm	160* kg / m ²
Max snow load - secondary beam on every 300 mm	240* kg / m ²

PROFILE 24

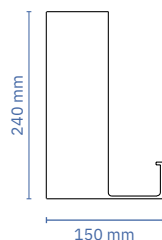

POSTS

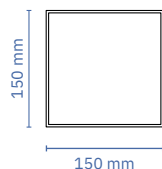

SECONDARY BEAM PROFILE

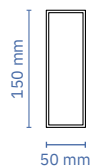

ROOF

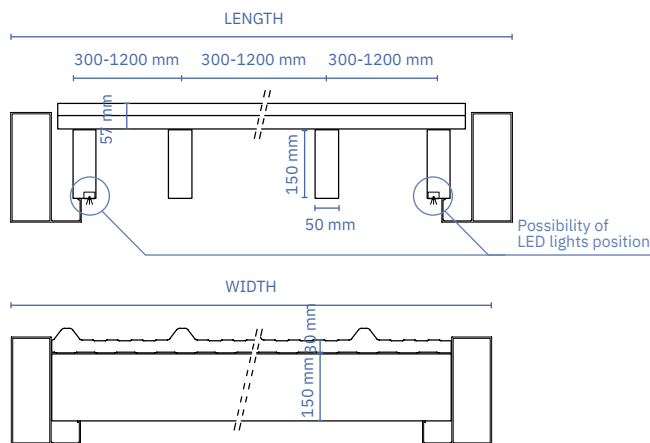

ROOF INCLINATION

Roof has 2% drop due to water runoff towards the water exits. Resulting in poles of different heights.

WATER EXITS

Water exits are on P1, P2 and P9.

HIGH CORROSION RESISTANCE

Frame parts are made exclusively of aluminium and stainless steel.

8.5x8.5m

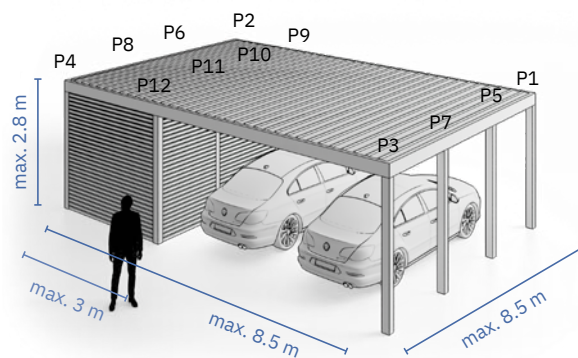

The image is symbolic and applies to all types. For max. dimensions for each type see Order form.

* Carport structure is designed using the Eurocode standards. It is assembled according to EN 1090 standard. The prescribed maximal loads are calculated for three different scenarios, for maximal combined load of 100, 160 and 240 kg/m². These loads are already multiplied by safety factors and include wind and snow loads.



2
cars

Price list

Soltec Carport + Right Box SL 240

	Snow load [kg/m ²]	Number of cars	Max Width [mm]	Max Length [mm]	Max Height [mm]	Max Area [m ²]	Price €/pc
Carport SL 240 / 100	100	2	8500	5000	2800	43	13.931 €
Carport SL 240 / 160	160	2	8500	5000	2800	43	16.679 €
Carport SL 240 / 240	240	2	8500	5000	2800	43	19.681 €
Carport SL 240 / 100	100	2	8500	5500	2800	47	15.325 €
Carport SL 240 / 160	160	2	8500	5500	2800	47	18.346 €
Carport SL 240 / 240	240	2	8500	5500	2800	47	21.648 €
Carport SL 240 / 100	100	2	8500	6000	2800	51	15.922 €
Carport SL 240 / 160	160	2	8500	6000	2800	51	19.061 €
Carport SL 240 / 240	240	2	8500	6000	2800	51	22.492 €
Carport SL 240 / 100	100	2	8500	6500	2800	55	16.764 €
Carport SL 240 / 160	160	2	8500	6500	2800	55	19.996 €
Carport SL 240 / 240	240	2	8500	6500	2800	55	23.595 €
Carport SL 240 / 100	100	2	8500	7000	2800	60	17.646 €
Carport SL 240 / 160	160	2	8500	7000	2800	60	21.053 €
Carport SL 240 / 240	240	2	8500	7000	2800	60	24.842 €
Carport SL 240 / 100	100	2	8500	7500	2800	64	18.270 €
Carport SL 240 / 160	160	2	8500	7500	2800	64	21.803 €
Carport SL 240 / 240	240	2	8500	7500	2800	64	25.728 €
Carport SL 240 / 100	100	2	8500	8000	2800	68	19.033 €
Carport SL 240 / 160	160	2	8500	8000	2800	68	22.716 €
Carport SL 240 / 240	240	2	8500	8000	2800	68	26.805 €
Carport SL 240 / 100	100	2	8500	8500	2800	72	19.827 €
Carport SL 240 / 160	160	2	8500	8500	2800	72	23.667 €
Carport SL 240 / 240	240	2	8500	8500	2800	72	27.927 €

Number of posts depend on the selected type of Carport. Four posts with robust external foot mounting are included in price. Every additional post is charged according to the price list on page 38.

	Infill	Width [mm]	Max Length [mm]	Max Height [mm]	Max Area [m ²]	Price €/pc
BOX / ISO 3	Insulated panel 3 cm**	1200	8500	2800	10,2	5.772 €
BOX / ISO 3		1800	8500	2800	15,3	6.204 €
BOX / ISO 3		2400	8500	2800	20,4	6.635 €
BOX / ISO 3		3000	8500	2800	25,5	7.066 €
BOX / WOOD	Siberian larch wood slats 24/70	1200	8500	2800	10,2	6.922 €
BOX / WOOD		1800	8500	2800	15,3	7.449 €
BOX / WOOD		2400	8500	2800	20,4	7.976 €
BOX / WOOD		3000	8500	2800	25,5	8.503 €
BOX / L44 - ES	Aluminium Expanded Metal Sheet*	1200	8500	2800	10,2	14.394 €
BOX / L44 - ES		1800	8500	2800	15,3	15.544 €
BOX / L44 - ES		2400	8500	2800	20,4	16.694 €
BOX / L44 - ES		3000	8500	2800	25,5	17.843 €
BOX / L44 - ALU 20 / 20	Aluminium square profile 20/20*	1200	8500	2800	10,2	16.694 €
BOX / L44 - ALU 20 / 20		1800	8500	2800	15,3	18.035 €
BOX / L44 - ALU 20 / 20		2400	8500	2800	20,4	19.376 €
BOX / L44 - ALU 20 / 20		3000	8500	2800	25,5	20.717 €

One door with a lock is included in price of the Box.

* Colour for STRUCTURE (profile, posts, secondary beam profile) and Box Infill (Aluminium Expanded Metal Sheet, Aluminium square profil 20/20).

** Colour for Insulated panel 3 cm (ROOF / BOX & WALL PANELS).

Carport structure is designed using the Eurocode standards. It is assembled according to EN 1090 standard. The prescribed maximal loads are calculated for three different scenarios, for maximal combined load of 100, 160 and 240 kg/m². These loads are already multiplied by safety factors and include wind and snow loads.

Limit loads and special requirements:

The bearing structure is designed for the utilization of the profiles material up to 80% under the prescribed maximal loads. The displacements of the structure (under self load) are limited to 1/500 x W, where W is the width of the Carport (Length of the secondary beam profile). Under full combination of snow and wind load the displacements are limited to 1/80 x W. The absolute displacements at the maximal loads and maximal span can reach 7 cm at span 6 m at the maximal loads. In the fully loaded condition with wind and snow it is advisable to remove the snow when the snow reaches a characteristic load of 75 kg / 125 kg / 180 kg according to the Eurocodes (first/second/third scenario). Even though the bearing capacity is higher, in this way the structure remains in a aesthetically pleasant shape. Special attention is necessary with choosing the right variant of the Carport. For different countries and different locations, different maximal prescribed loads are defined by the Eurocodes. It is necessary to choose the Carport variant, which is sufficient for the location and layout for which it is meant for. In different European countries there are different laws and regulations regarding Carport structures. It is possible, that the user has to acquire a building permit for the Carport structure. The building permit documentation and foundation of the Carport is the responsibility of the user. It is suggested to use a 25 cm thick concrete foundation plate for the cars and foundation of the carport.

Prices are defined and expressed in EUR. The prices are always before VAT. Any discounts shall be agreed upon in written form. The prices are ex-works Soltec headquarters. Packaging excluded.

2
cars

Technical details

Soltec Carport + Right Box SL 240

Right Box 240/2 Left Box 240/2 Back Box 240/2 240/2 Right Box 170/1 Left Box 170/1 Back Box 170/1 170/1

Roof cover	Insulated panels 3 cm
Frame	240/150
Secondary beam profile	150/50
Post	150/150
Max width	8500 mm
Box dimensions	L x 1.2 m - L x 3 m (up to 25.5 m ²)
Max Length on 3 posts (max distance between posts 4,7 m)	8500 mm
Foot type (optional: painting or stainless steel)	External 150 - galvanized
N° of water exits	3
Max snow load - secondary beam on every 1200 mm	100* kg / m ²
Max snow load - secondary beam on every 600 mm	160* kg / m ²
Max snow load - secondary beam on every 300 mm	240* kg / m ²

PROFILE 24

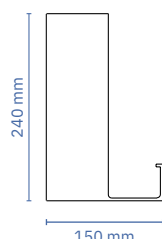

POSTS

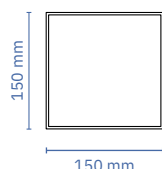

SECONDARY BEAM PROFILE

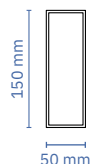

ROOF

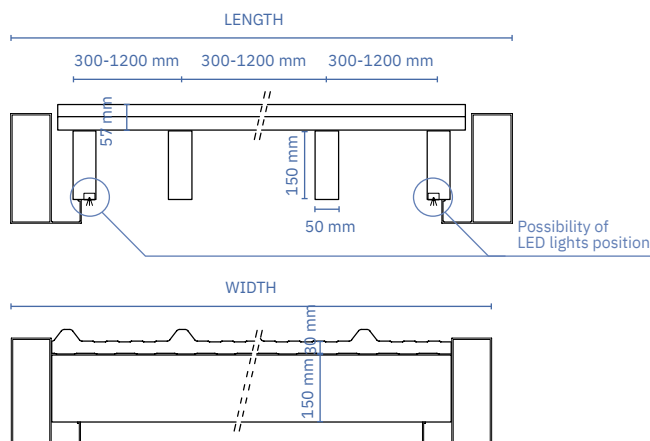

ROOF INCLINATION

Roof has 2% drop due to water runoff towards the water exits. Resulting in poles of different heights.

WATER EXITS

Water exits are on P1, P2 and P9.

HIGH CORROSION RESISTANCE

Frame parts are made exclusively of aluminium and stainless steel.

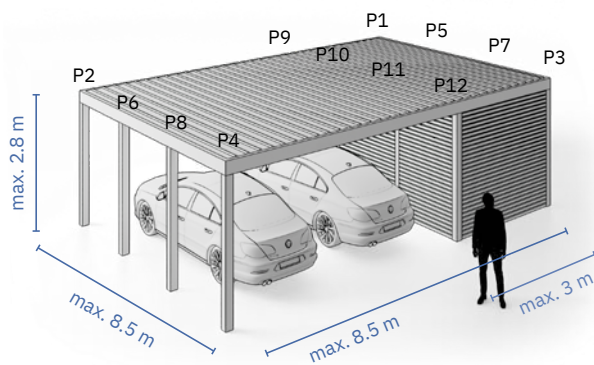

The image is symbolic and applies to all types. For max. dimensions for each type see Order form.

* Carport structure is designed using the Eurocode standards. It is assembled according to EN 1090 standard. The prescribed maximal loads are calculated for three different scenarios, for maximal combined load of 100, 160 and 240 kg/m². These loads are already multiplied by safety factors and include wind and snow loads.



Types of installations Soltec Carport SL 240

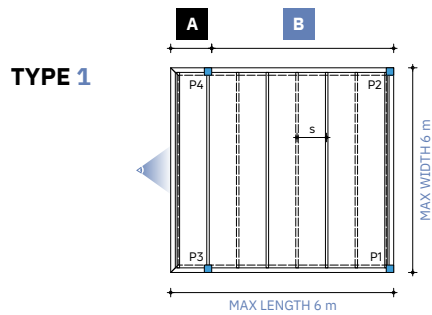

- Secondary beams, for load capacity:
 - 100 kg/m²: $s_{max} = 1,2$ m,
 - 160 kg/m²: $s_{max} = 0,6$ m,
 - 240 kg/m²: $s_{max} = 0,3$ m, post distance max. 3 m
- Additional secondary beams for a higher load capacity
- Post position
- Walls

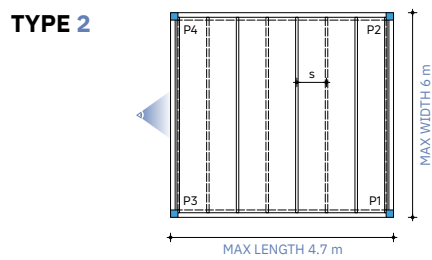

Load capacity [kg/m ²]		100	160	240
s	max distance between secondary beams [mm]	1200	600	300



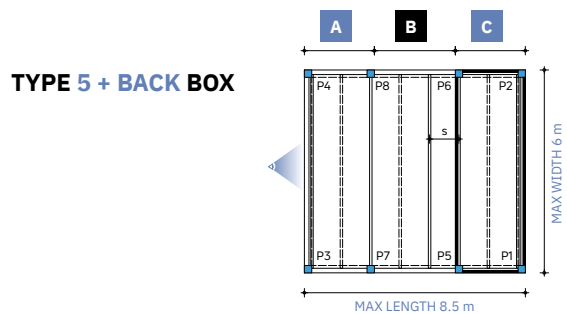
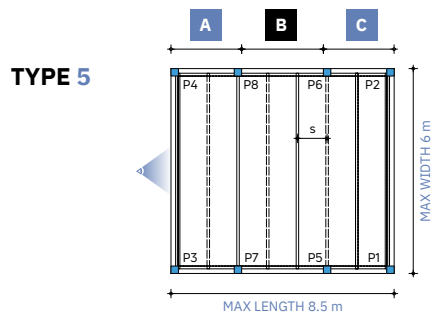
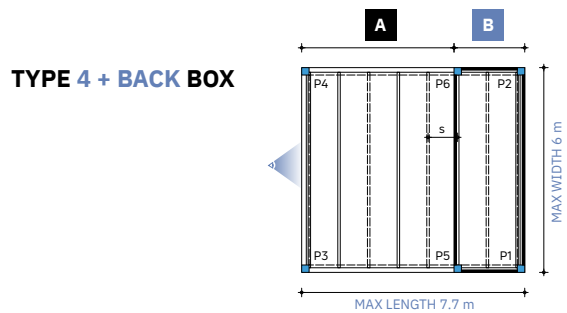
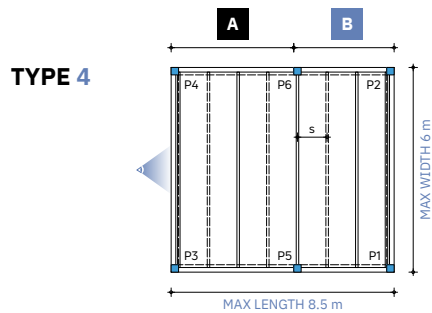
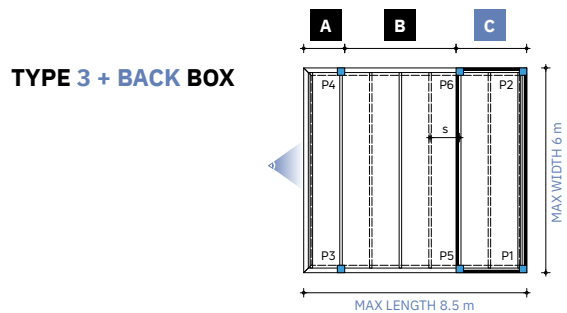
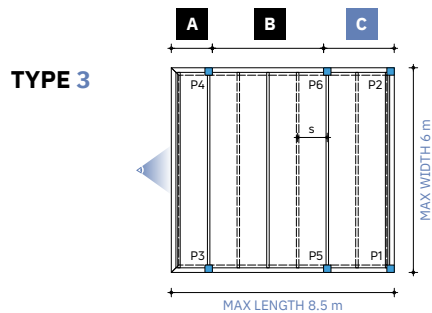

The maximum dimensions depend on the load capacity and selected type. For details look at the order form.



Types of installations

Soltec Carport

SL 240

-  Secondary beams, for load capacity:
 - 100 kg/m²: $s_{max} = 1,2$ m, post distance max. 3 m,
 - 160 kg/m²: $s_{max} = 0,6$ m, post distance max. 3 m,
 - 240 kg/m²: $s_{max} = 0,3$ m, post distance max. 3 m
-  Additional secondary beams for a higher load capacity
-  Post position
-  Walls

Load capacity [kg/m ²]		100	160	240
s	max distance between secondary beams [mm]	1200	600	300

The maximum dimensions depend on the load capacity and selected type. For details look at the order form.

TYPE 5 + LEFT BOX

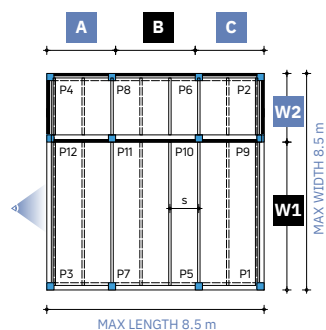

TYPE 5 + RIGHT BOX

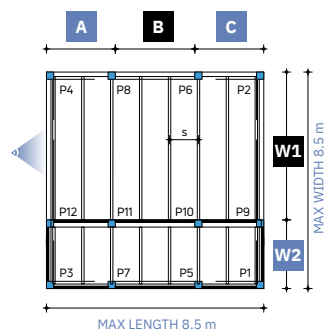

Possibilities

1
car

Box SL 170

Box dimensions

3.14 m x 1.2 m - 3.14 m x 3 m
(3.8 m² - 9.4 m²)

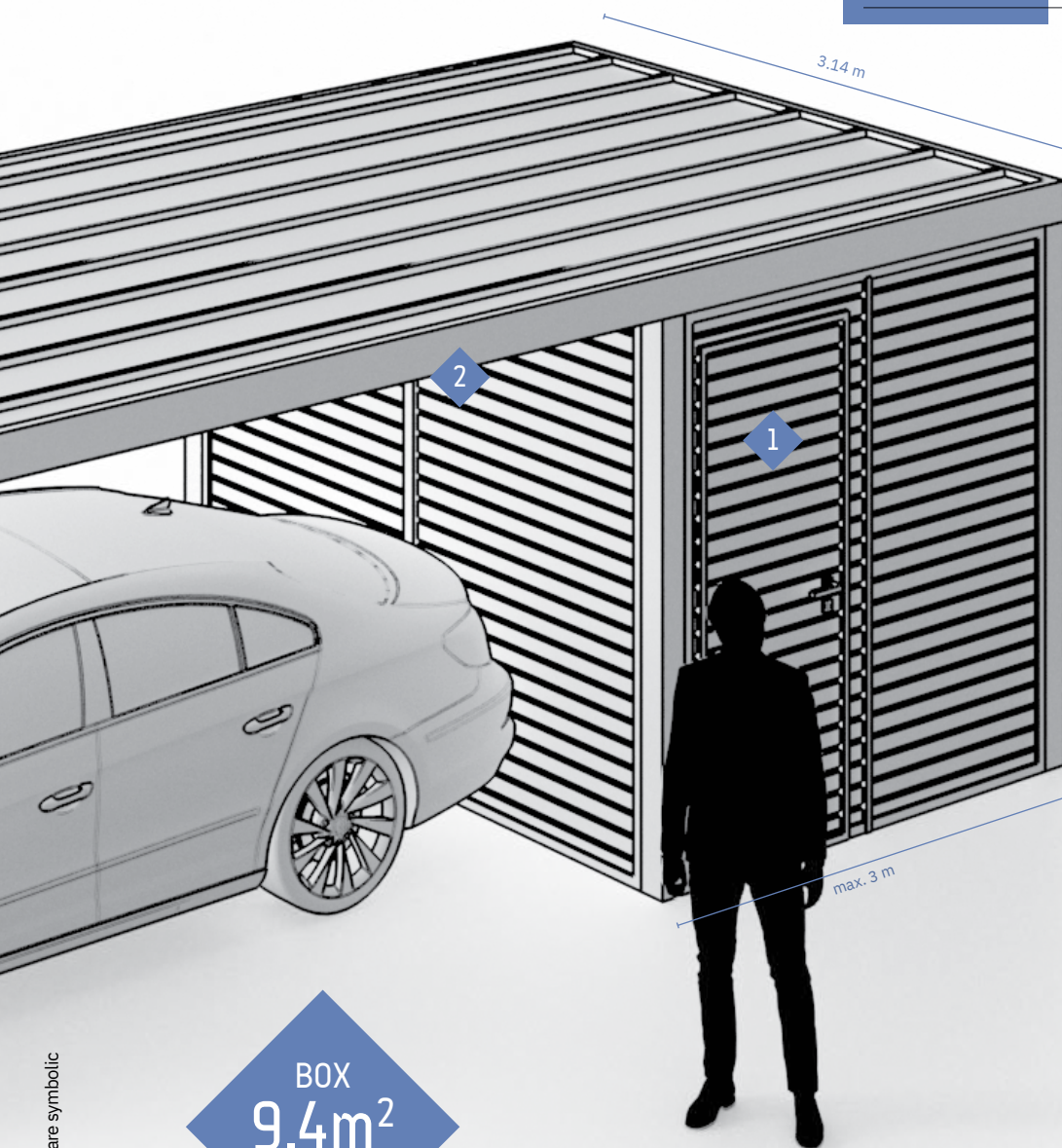

EXCELLENT FOR



Workshop



Gardening storage



Bike storage



Exercise equipment storage



Home brewery

FEATURES



Integrated door



Possibility of installing
LED lights

BOX
9.4m²

Images are symbolic

2
cars

Box SL 240

Box dimensions 6 m x 1.2 m - 6 m x 3 m
(7 m² - 18 m²)

EXCELLENT FOR



Workshop



Gardening storage



Bike storage



Exercise equipment storage



Home brewery

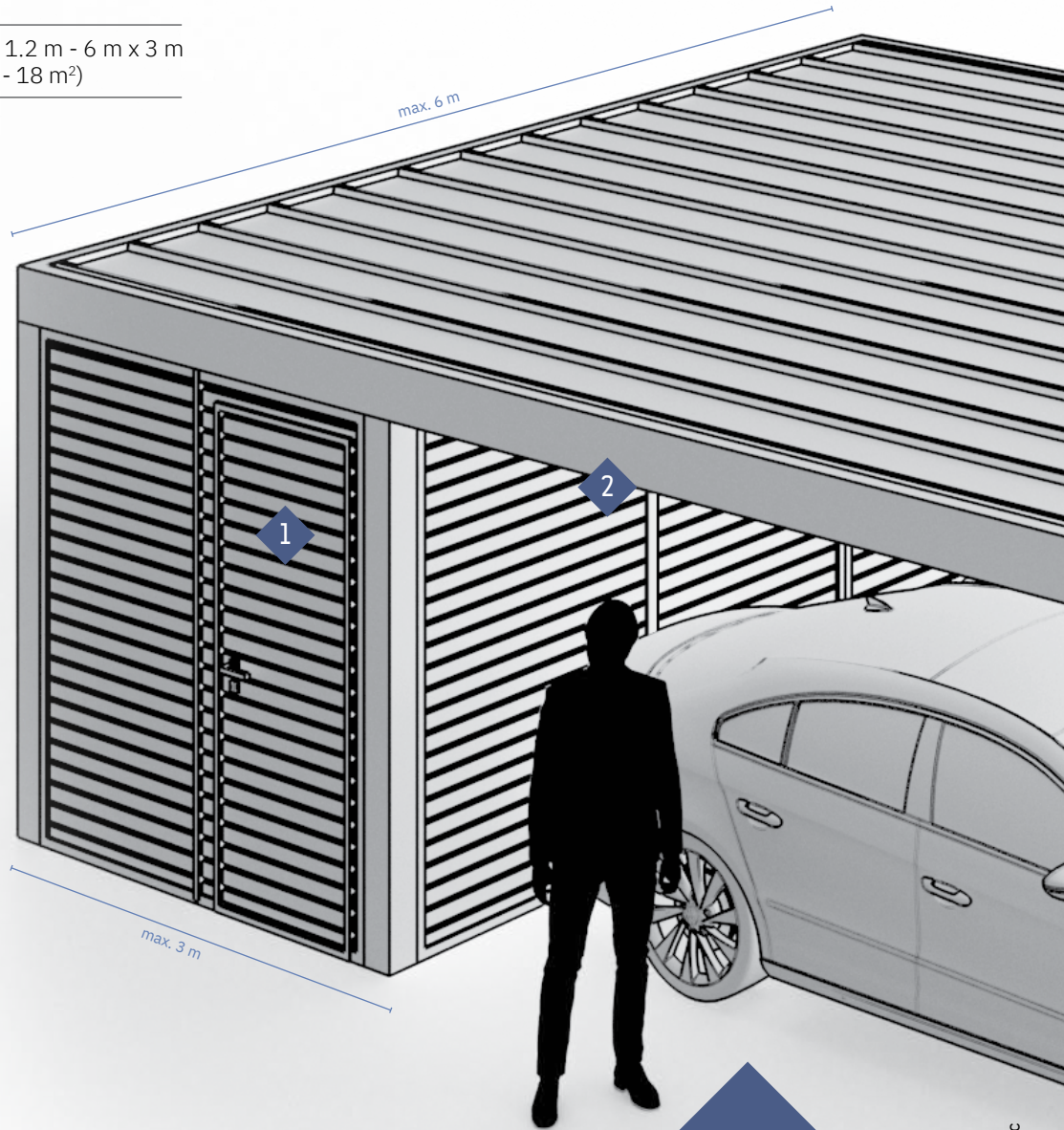

FEATURES

1



Integrated door

2



Possibility of installing LED lights

BOX
18m²

Images are symbolic

Options

Doors

LEFT HAND DOOR OPENING

Opening outwards relative to the Box.
Hinges are on the left side of the door.
Door can be on any post of the Box.

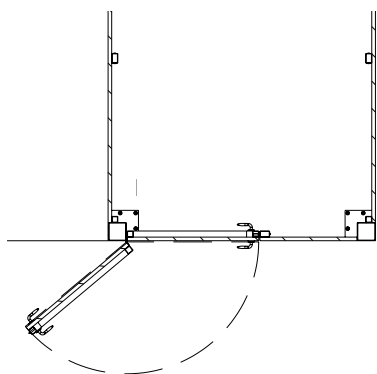

RIGHT HAND DOOR OPENING

Opening outwards relative to the Box.
Hinges are on the right side of the door.
Door can be on any post of the Box.

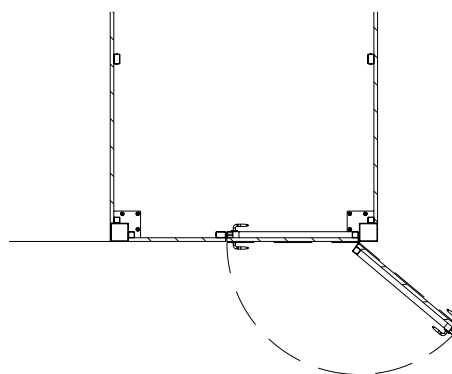

Accessories

ADDITIONAL

	Pcs	€
Additional door with handle and locker	1	551 €
Post 120/120 , max distance 4,7 m	1	184 €
Post 150/150 , max distance 4,7 m	1	432 €
LED lights 1 m*	1	324 €
2 remote controllers including electronic for LED lights**	1 set	227 €
Dusk / down including electronic for LED lights	1 set	303 €
Movement sensor including electronic for LED lights	1 set	303 €
Switch for LED lights	1 set	411 €

* LED lights can be positioned on the first and last secondary beam profile.
** One remote if RGB.

WALL PANELS PRICE € per linear meter

	Height	€/ m
Wall / ISO 3 (insulated panel 3 cm)	1,5	196 €
Wall / ISO 3 (insulated panel 3 cm)	2	229 €
Wall / ISO 3 (insulated panel 3 cm)	2,5	327 €
Wall / WOOD (siberian larch wooden slats)	1,5	240 €
Wall / WOOD (siberian larch wooden slats)	2	280 €
Wall / WOOD (siberian larch wooden slats)	2,5	400 €
Wall / L44 - ES (expanded sheet panels)	1,5	523 €
Wall / L44 - ES (expanded sheet panels)	2	610 €
Wall / L44 - ES (expanded sheet panels)	2,5	871 €
Wall / L44 - ALU 20 / 20 (aluminium slats panels)	1,5	610 €
Wall / L44 - ALU 20 / 20 (aluminium slats panels)	2	712 €
Wall / L44 - ALU 20 / 20 (aluminium slats panels)	2,5	1.017 €

Options

Wall panels

WALL / ISO 3

Insulated panel 3 cm

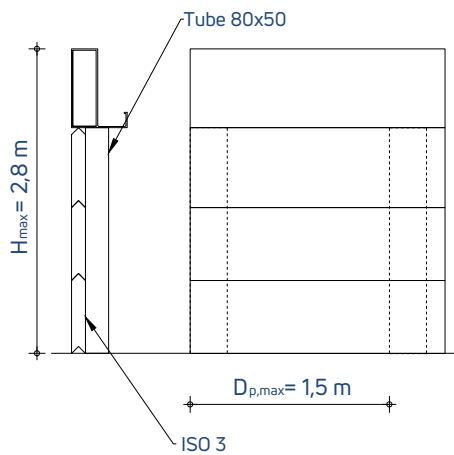

$D_{p,max}$ - maximum distance between two box posts

WALL / WOOD

Siberian larch wooden slats

Grade A quality wood

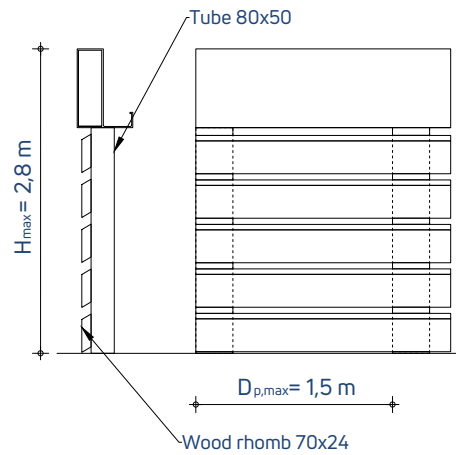

WALL / L44 - ES

Expanded sheet panels

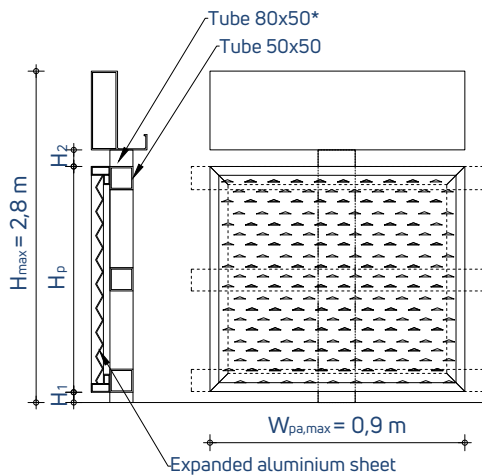

* max distance between two box posts is 3 m

WALL / L44 - ALU 20/20

Aluminium slats panels

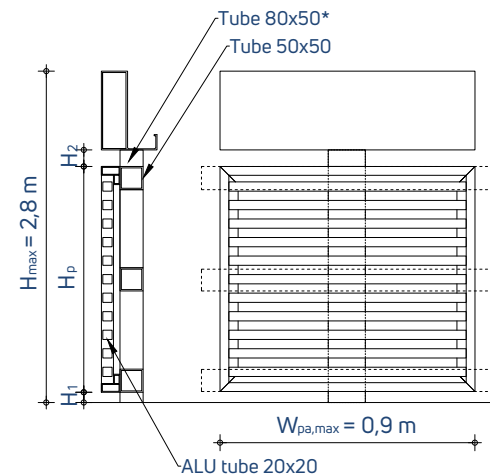

$W_{pa,max}$ - maximum panel width

* max distance between two box posts is 3 m

Options

Solar Pack

	Solar Pack 1	Solar Pack 2	Solar Pack 3	Solar Pack 4
Number of cars	1 car	1 car	2 cars	2 cars
Number of solar panels	4 pcs	6 pcs	10 pcs	15 pcs
Power of solar panels [kW]	2,25	3,3	5,6	8,4
Inverter capacity [kW]	12	12	12	12
Charging station capacity [kW]	12/22	12/22	12/22	12/22

Battery pack available as an option. Capacity for 1 battery modul is 5kWh.

Functional overview

Off grid system

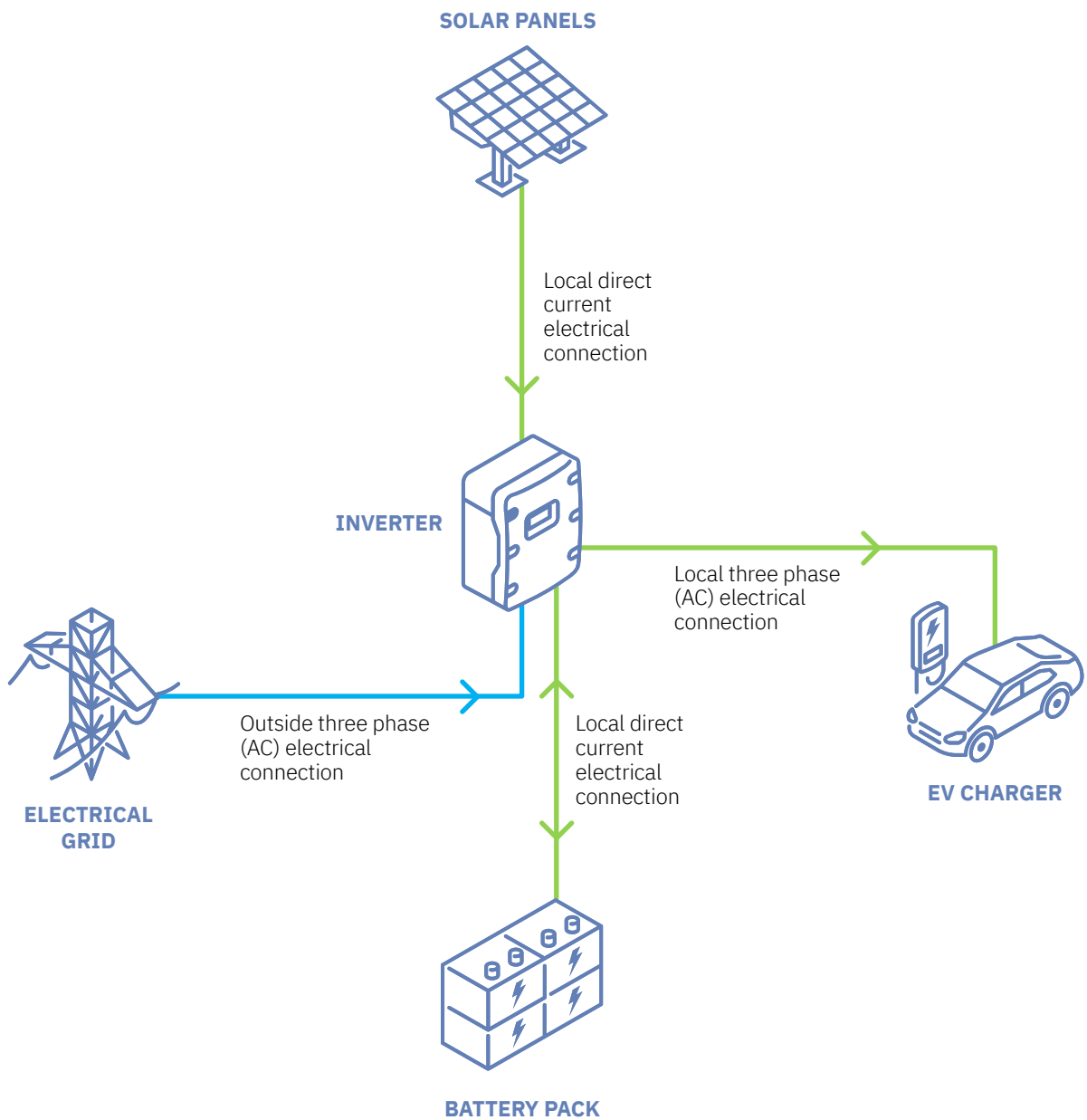

Options Roof

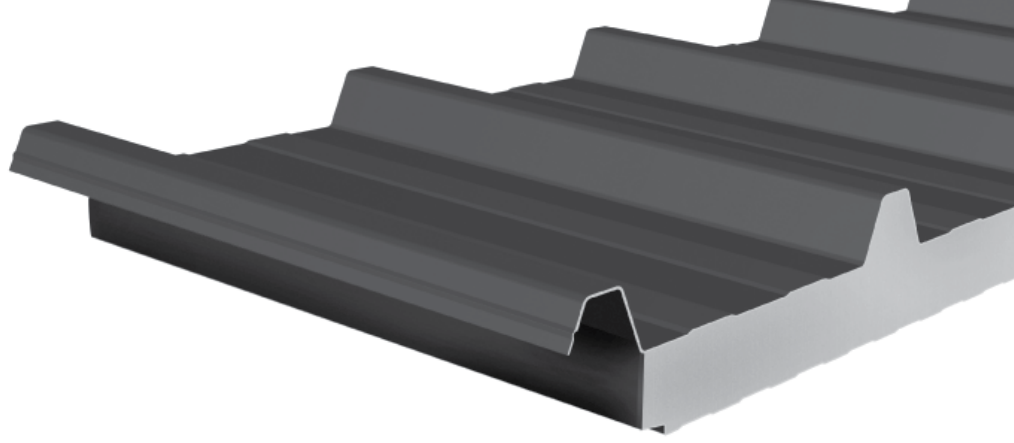

SL 170 ISO panel

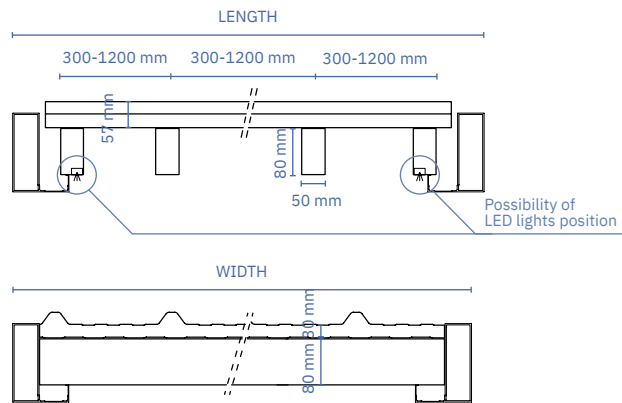

SL 170 Glass (optional ALU sheet)

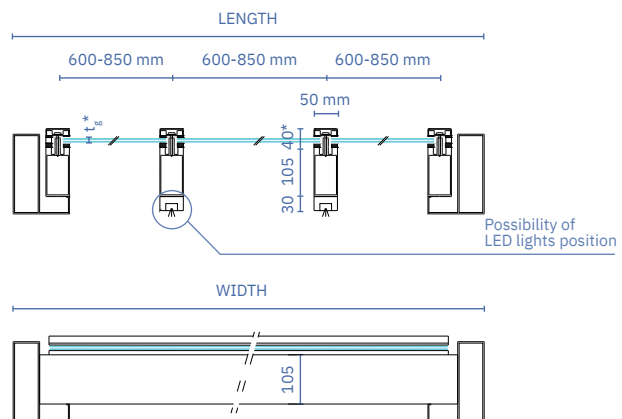

SL 240 ISO panel

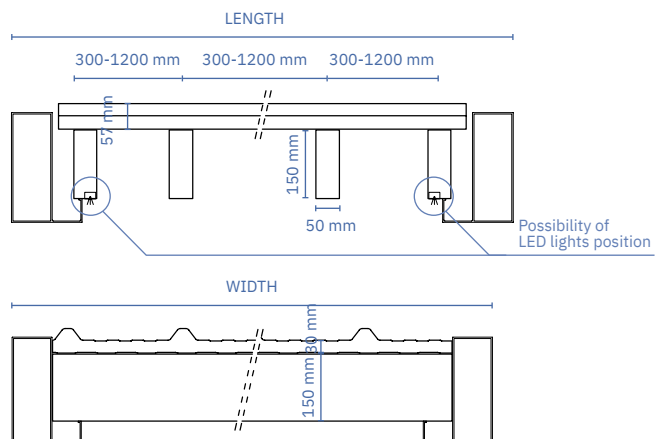

Options

Special water evacuation

TYPE V

Vertical evacuation through rain gutter with ALU tube \varnothing 50 mm

Position of water location and type must be marked on drawing.

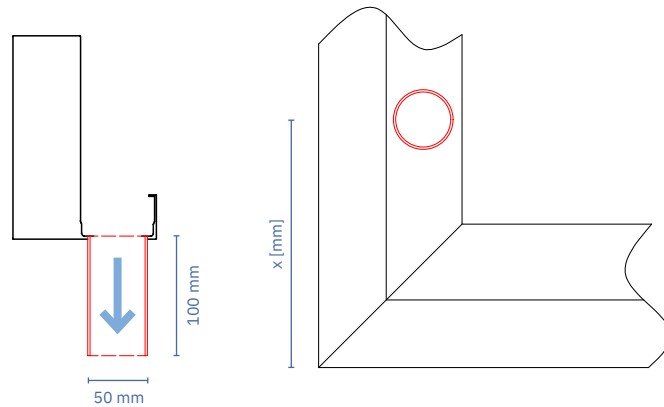

TYPE H

Horizontal evacuation through beam with ALU tube \varnothing 50 mm

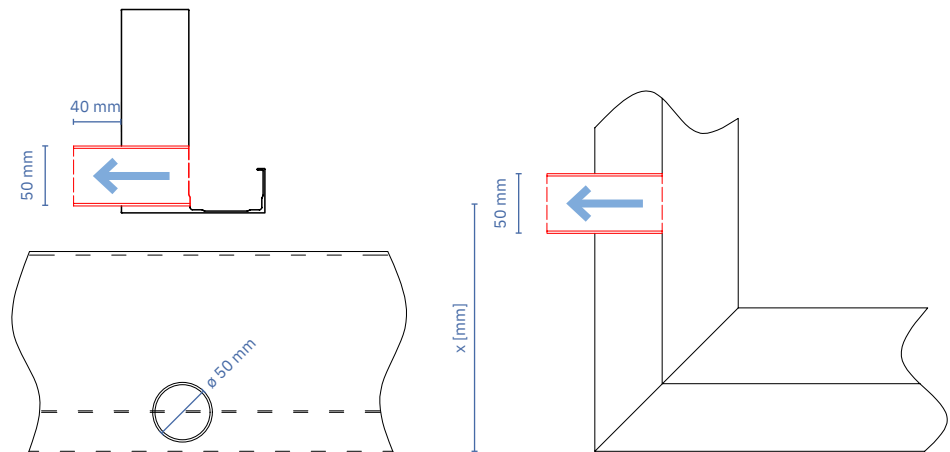

TYPE P

Horizontal evacuation through beam with PVC tube \varnothing 50 mm

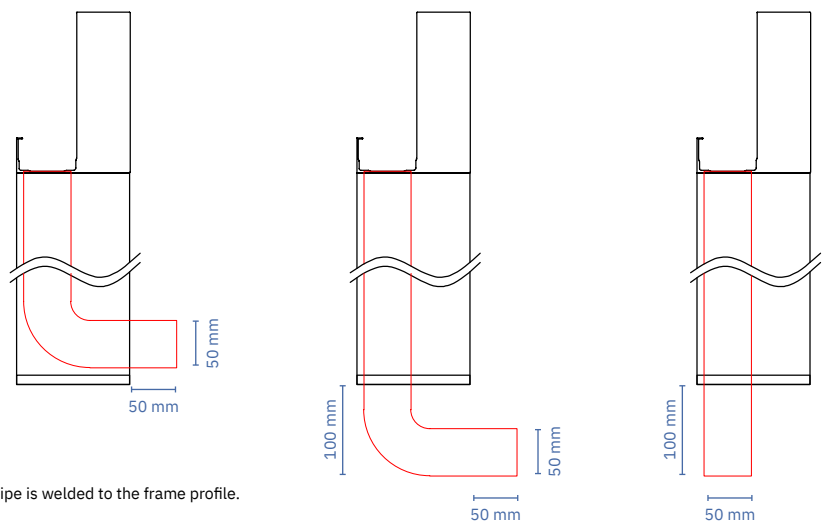

Subject to additional payment 170 € / pcs. Water exit pipe is welded to the frame profile.

Options

Foot mounting

OPTIONAL / EXTERNAL

Protection:

- galvanization (130 €/piece),
- galvanization + painting (170 €/piece),
- stainless steel (320 €/piece)

EXTERNAL 1

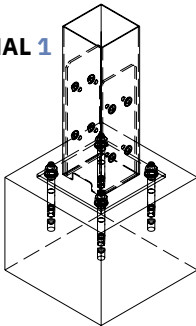

EXTERNAL 2

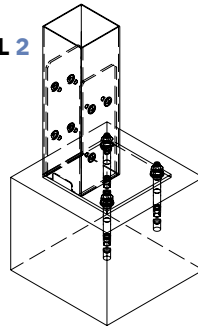

EXTERNAL 3

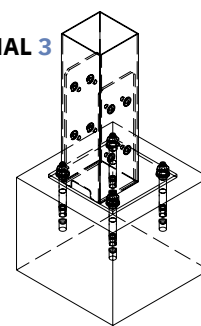

Posts 120/120

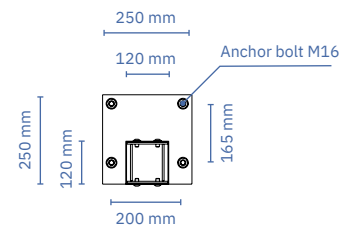
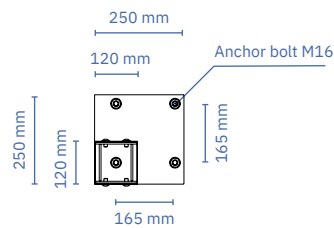
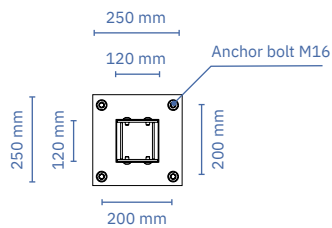

Posts 150/150

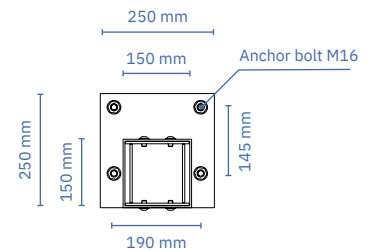
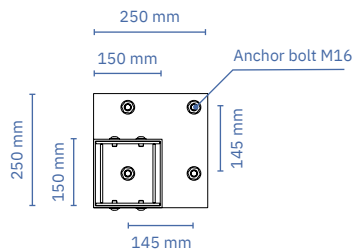
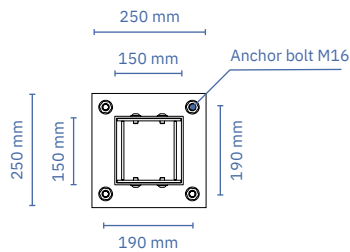

Anchor bolts are included in the price.

Options

Wall mounting

STANDARD

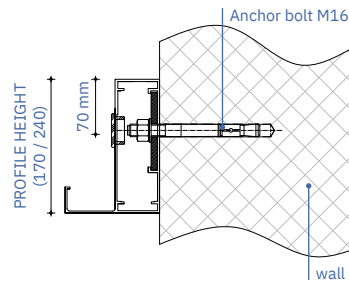

OPTIONAL 1

Subject to additional payment of 60 €/piece

Protection:

- galvanization

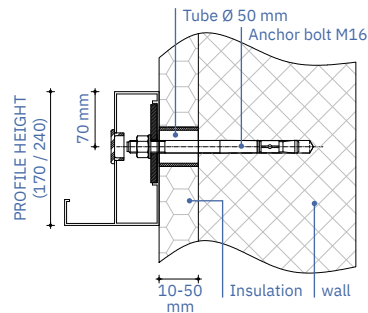

OPTIONAL 2

Subject to additional payment.

Protection:

- galvanization (130 €/piece),
- galvanization + painting (170 €/piece),
- stainless steel (320 €/piece)

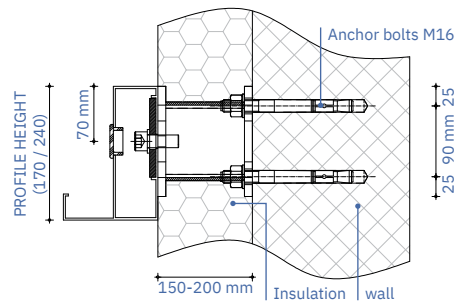

OPTIONAL 3

Subject to additional payment.

Protection:

- galvanization (130 €/piece),
- galvanization + painting (170 €/piece),
- stainless steel (320 €/piece)

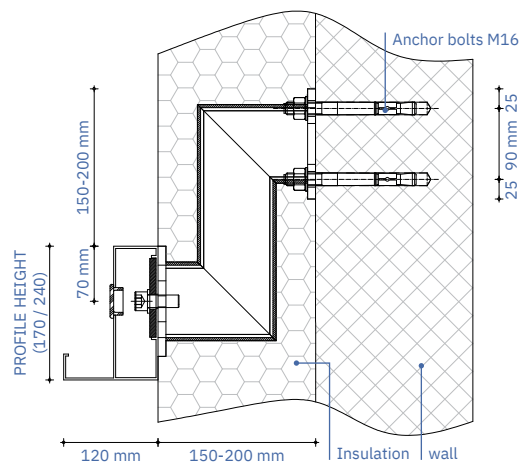

Anchor bolts are included in the price.

Order form

Soltec **Carport**
SL

Step 1 / Client information

Client

Name
Address
Phone
E-mail

Project

Name
Date
Requested date of delivery (week)

Deliver to (when different)

Name
Address
Phone
E-mail

Stamp & signature

The customer declares that he/she understands and accepts the general sales conditions stipulated in the General Sales Conditions and Warranty published on soltec.si.

Step 2 / Product information

2.1 Type of Carport / 1 car

Select the load capacity for the type of Carport you are ordering:



Carport SL
170 max load
capacity

- 100 kg/m²
- 160 kg/m²
- 240 kg/m²



Carport + Back Box
SL 170 max
load capacity

- 100 kg/m²
- 160 kg/m²
- 240 kg/m²

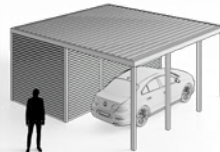

Carport + Left Box
SL 170 max load
capacity

- 100 kg/m²
- 160 kg/m²
- 240 kg/m²



Carport + Right Box
SL 170 max
load capacity

- 100 kg/m²
- 160 kg/m²
- 240 kg/m²

2.2 Type of Carport / 2 cars



Carport SL
240 max load
capacity

- 100 kg/m²
- 160 kg/m²
- 240 kg/m²

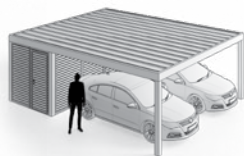

Carport + Back Box
SL 240 max
load capacity

- 100 kg/m²
- 160 kg/m²
- 240 kg/m²



Carport + Left Box
SL 240 max load
capacity

- 100 kg/m²
- 160 kg/m²
- 240 kg/m²



Carport + Right Box
SL 240 max load
capacity

- 100 kg/m²
- 160 kg/m²
- 240 kg/m²



Be careful not to exceed the **MAX** dimensions according to the selected load capacity

Soltec Carport SL

2.3 Type of installation / 1 car

- Type 1 / **Carport 170**
* Fill in with your data

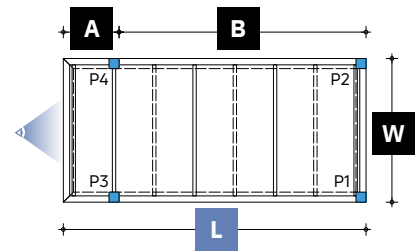
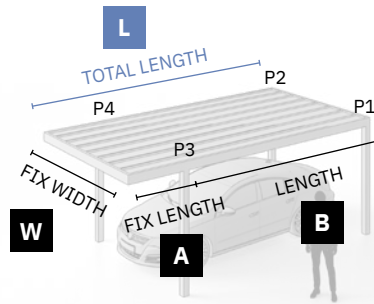

	Load capacity [kg/m ²]	100	160	240	* Your data [mm]
W	FIX WIDTH [mm]	3140	3140	3140	3140
A	FIX LENGTH [mm]	1300	1300	1300	1300
B	LENGTH [mm]	max 4700	max 4700	max 3000	B = L - A
L (A + B)	TOTAL LENGTH [mm]	max 6000	max 6000	max 4300	*

Minimum length of a straight segment is 1000 mm.

- Type 2 / **Carport 170**
* Fill in with your data

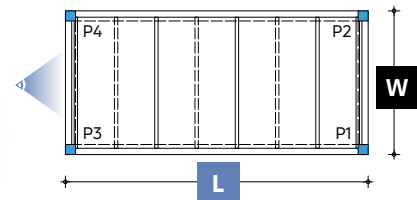
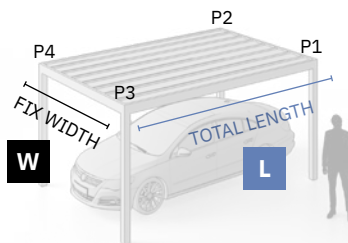

	Load capacity [kg/m ²]	100	160	240	* Your data [mm]
W	FIX WIDTH [mm]	3140	3140	3140	3140
L	TOTAL LENGTH [mm]	max 4700	max 4700	max 3000	*

Minimum length of a straight segment is 1000 mm.



Be careful not to exceed the **MAX** dimensions according to the selected load capacity

Soltec Carport SL

Type 3 / **Carport 170**
* Fill in with your data

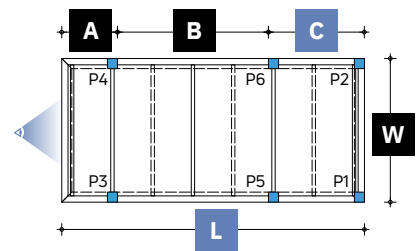
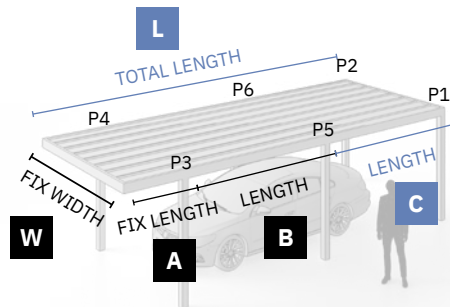

	Load capacity [kg/m ²]	100	160	240	* Your data [mm]
W	FIX WIDTH [mm]	3140	3140	3140	3140
A	FIX LENGTH [mm]	1300	1300	1300	1300
B	LENGTH [mm]	max 4700	max 4700	max 3000	B = L - A - C
C	LENGTH [mm]	max 4700	max 4700	max 3000	*
L (A + B + C)	TOTAL LENGTH [mm]	max 8000	max 8000	max 7300	*

Minimum length of a straight segment is 1000 mm.

Type 4 / **Carport 170**
* Fill in with your data

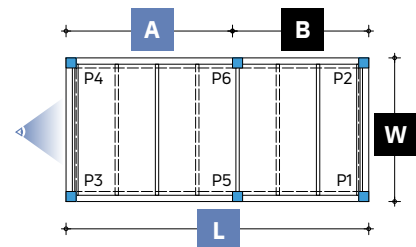
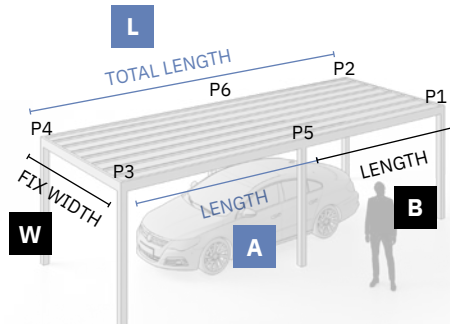

	Load capacity [kg/m ²]	100	160	240	* Your data [mm]
W	FIX WIDTH [mm]	3140	3140	3140	3140
A	FIX LENGTH [mm]	max 4700	max 4700	max 3000	*
B	LENGTH [mm]	max 4700	max 4700	max 3000	B = L - A
L (A + B)	TOTAL LENGTH [mm]	max 8000	max 8000	max 6000	*

Minimum length of a straight segment is 1000 mm.



Be careful not to exceed the **MAX** dimensions according to the selected load capacity

Soltec Carport SL

- Type 5 / **Carport 170**
* Fill in with your data

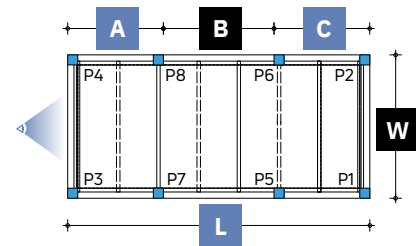
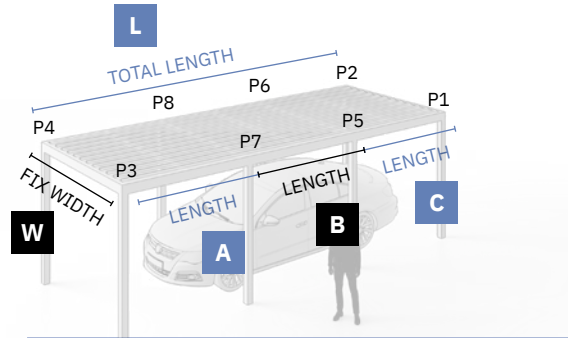

	Load capacity [kg/m ²]	100	160	240	* Your data [mm]
W	FIX WIDTH [mm]	3140	3140	3140	3140
A	LENGTH [mm]	max 4700	max 4700	max 3000	*
B	LENGTH [mm]	max 4700	max 4700	max 3000	B = L - A - C
C	LENGTH [mm]	max 4700	max 4700	max 3000	*
L (A + B + C)	TOTAL LENGTH [mm]	max 8000	max 8000	max 8000	*

Minimum length of a straight segment is 1000 mm.

- Type 3 / **Carport 170 + Back Box**
* Fill in with your data

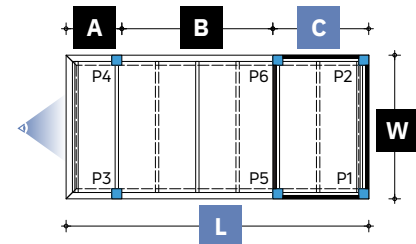
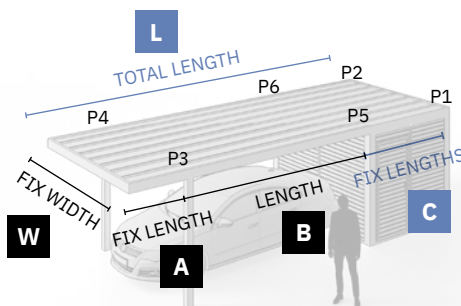

	Load capacity [kg/m ²]	100	160	240	* Your data [mm]
W	FIX WIDTH [mm]	3140	3140	3140	3140
A	FIX LENGTH [mm]	1300	1300	1300	1300
B	LENGTH [mm]	max 4700	max 4700	max 3000	B = L - A - C
C	FIX LENGTH [mm]	1200 or 1800 or 2400 or 3000	1200 or 1800 or 2400 or 3000	1200 or 1800 or 2400 or 3000	*
L (A + B + C)	TOTAL LENGTH [mm]	max 8000	max 8000	max 7300	*

Minimum length of a straight segment is 1000 mm.



Be careful not to exceed the MAX dimensions according to the selected load capacity

Soltec Carport SL

Type 4 / **Carport 170 + Back Box**
* Fill in with your data

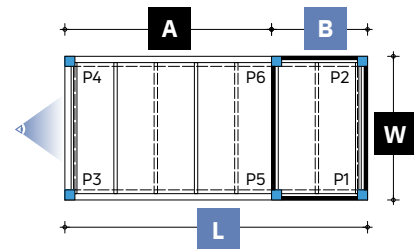
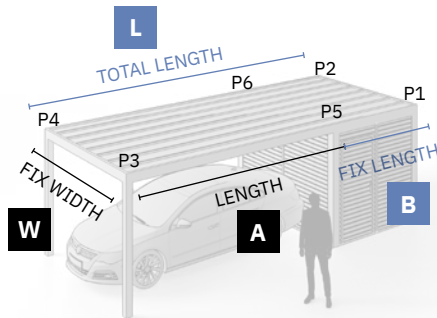

	Load capacity [kg/m ²]	100	160	240	* Your data [mm]
W	FIX WIDTH [mm]	3140	3140	3140	3140
A	LENGTH [mm]	max 4700	max 4700	max 3000	A = L - B
B	FIX LENGTH [mm]	1200 or 1800 or 2400 or 3000	1200 or 1800 or 2400 or 3000	1200 or 1800 or 2400 or 3000	*
L (A + B)	TOTAL LENGTH [mm]	max 7700	max 7700	max 6000	*

Minimum length of a straight segment is 1000 mm.

Type 5 / **Carport 170 + Back Box**
* Fill in with your data

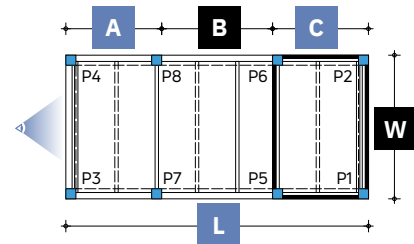
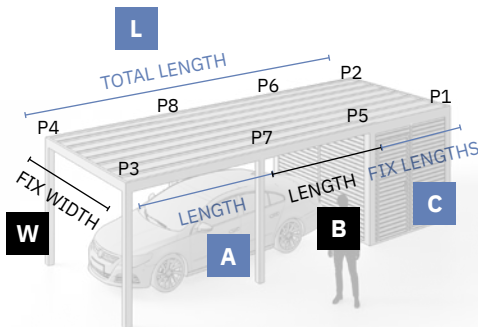

	Load capacity [kg/m ²]	100	160	240	* Your data [mm]
W	FIX WIDTH [mm]	3140	3140	3140	3140
A	LENGTH [mm]	max 4700	max 4700	max 3000	*
B	LENGTH [mm]	max 4700	max 4700	max 3000	B = L - A - C
C	FIX LENGTH [mm]	1200 or 1800 or 2400 or 3000	1200 or 1800 or 2400 or 3000	1200 or 1800 or 2400 or 3000	*
L (A + B + C)	TOTAL LENGTH [mm]	max 8000	max 8000	max 8000	*

Minimum length of a straight segment is 1000 mm.



Be careful not to exceed the **MAX** dimensions according to the selected load capacity

Soltec Carport SL

- Type 4 / **Carport 170 + Left Box**
* Fill in with your data

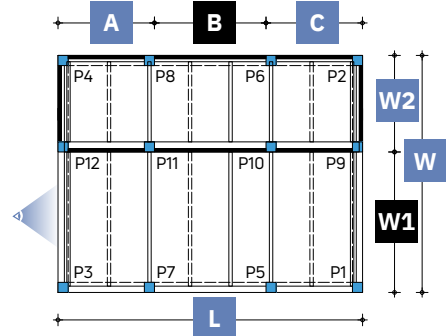
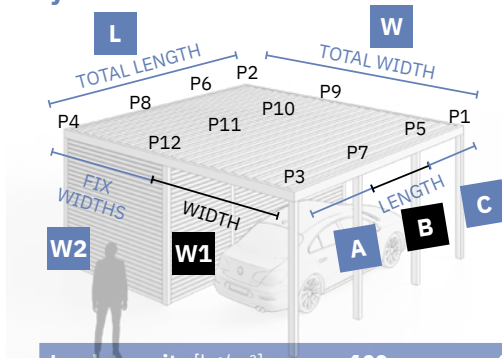

	Load capacity [kg/m ²]	100	160	240	* Your data [mm]
W (W1 + W2)	TOTAL WIDTH [mm]	max 6000	max 6000	max 6000	*
W1	WIDTH [mm]	max 3000	max 3000	max 3000	W1 = W - W2
W2	FIX WIDTH [mm]	1200 or 1800 or 2400 or 3000	1200 or 1800 or 2400 or 3000	1200 or 1800 or 2400 or 3000	*
A	LENGTH [mm]	max 3000	max 3000	max 3000	*
B	LENGTH [mm]	max 3000	max 3000	max 3000	B = L - A - C
C	LENGTH [mm]	max 3000	max 3000	max 3000	*
L (A + B + C)	TOTAL LENGTH [mm]	max 8000	max 8000	max 8000	*

Minimum length of a straight segment is 1000 mm.



Be careful not to exceed the **MAX** dimensions according to the selected load capacity

Soltec Carport SL

- Type 5 / **Carport 170 + Right Box**
* Fill in with your data

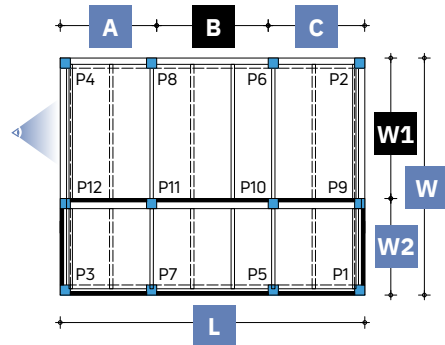
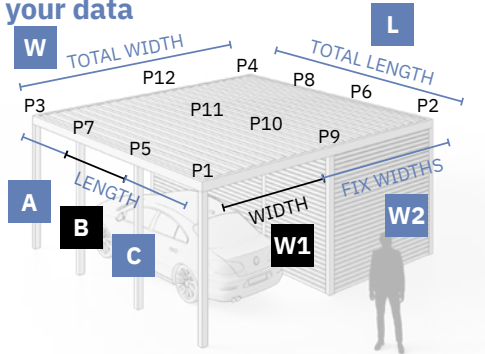

	Load capacity [kg/m ²]	100	160	240	* Your data [mm]
W (W1 + W2)	TOTAL WIDTH [mm]	max 6000	max 6000	max 6000	*
W1	WIDTH [mm]	max 3000	max 3000	max 3000	W1 = W - W2
W2	FIX WIDTH [mm]	1200 or 1800 or 2400 or 3000	1200 or 1800 or 2400 or 3000	1200 or 1800 or 2400 or 3000	*
A	LENGTH [mm]	max 3000	max 3000	max 3000	*
B	LENGTH [mm]	max 3000	max 3000	max 3000	B = L - A - C
C	LENGTH [mm]	max 3000	max 3000	max 3000	*
L (A + B + C)	TOTAL LENGTH [mm]	max 8000	max 8000	max 8000	*

Minimum length of a straight segment is 1000 mm.



Be careful not to exceed the **MAX** dimensions according to the selected load capacity

Soltec **Carport** SL

2.4 Type of installation / 2 cars

Type 1 / **Carport 240**

* Fill in with your data

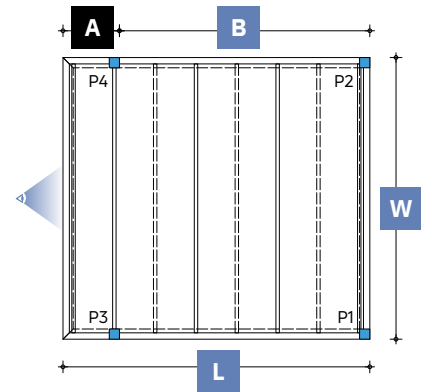
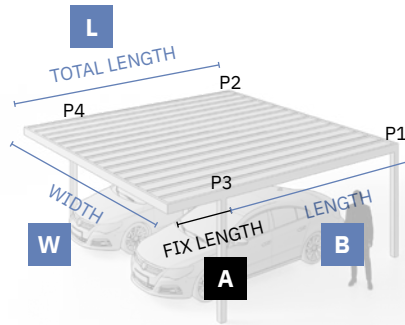

	Load capacity [kg/m ²]	100	160	240	* Your data [mm]
W	WIDTH [mm]	max 6000	max 6000	max 6000	*
A	FIX LENGTH [mm]	1300	1300	1300	1300
B	LENGTH [mm]	max 4700	max 4700	max 3000	*
L (A + B)	TOTAL LENGTH [mm]	max 6000	max 6000	max 4300	*

Minimum length of a straight segment is 1000 mm.

Type 2 / **Carport 240**

* Fill in with your data

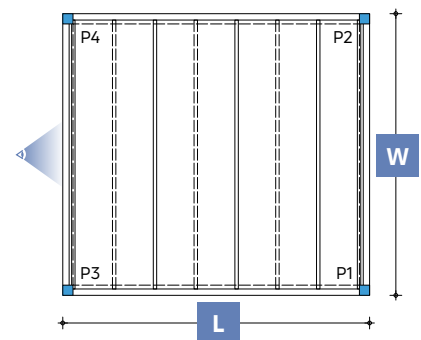
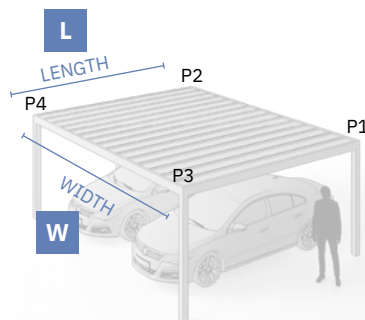

	Load capacity [kg/m ²]	100	160	240	* Your data [mm]
W	WIDTH [mm]	max 6000	max 6000	max 6000	*
L	LENGTH [mm]	max 4700	max 4700	max 3000	*

Minimum length of a straight segment is 1000 mm.



Be careful not to exceed the **MAX** dimensions according to the selected load capacity

Soltec **Carport** SL

Type 3 / **Carport 240**
* Fill in with your data

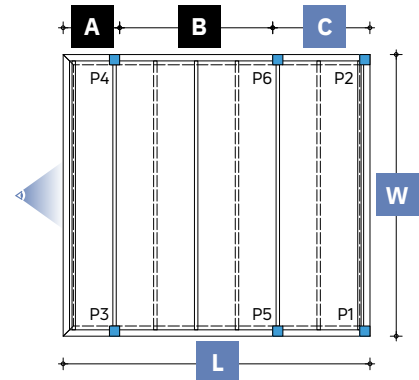
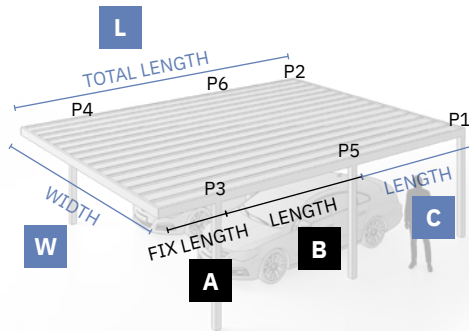

	Load capacity [kg/m ²]	100	160	240	* Your data [mm]
W	WIDTH [mm]	max 6000	max 6000	max 6000	*
A	FIX LENGTH [mm]	1300	1300	1300	1300
B	LENGTH [mm]	max 4700	max 4700	max 3000	B = L - A - C
C	LENGTH [mm]	max 4700	max 4700	max 3000	*
L (A + B + C)	TOTAL LENGTH [mm]	max 8500	max 8500	max 7300	*

Minimum length of a straight segment is 1000 mm.

Type 4 / **Carport 240**
* Fill in with your data

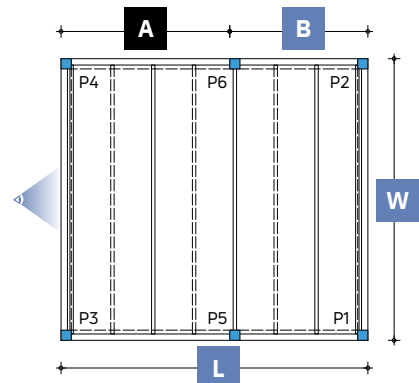
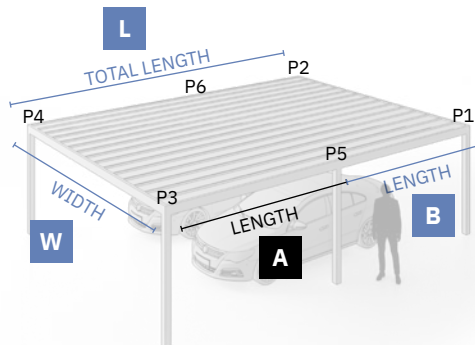

	Load capacity [kg/m ²]	100	160	240	* Your data [mm]
W	WIDTH [mm]	max 6000	max 6000	max 6000	*
A	LENGTH [mm]	max 4700	max 4700	max 3000	A = L - B
B	LENGTH [mm]	max 4700	max 4700	max 3000	*
L (A + B)	TOTAL LENGTH [mm]	max 8500	max 8500	max 6000	*

Minimum length of a straight segment is 1000 mm.



Be careful not to exceed the **MAX** dimensions according to the selected load capacity

Soltec Carport SL

- Type 5 / **Carport 240**
* Fill in with your data

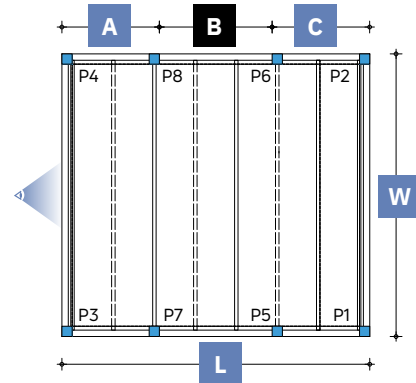
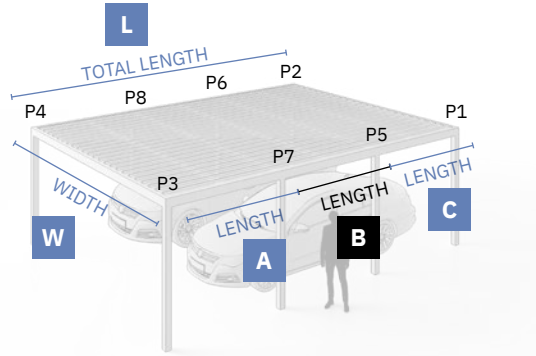

	Load capacity [kg/m ²]	100	160	240	* Your data [mm]
W	WIDTH [mm]	max 6000	max 6000	max 6000	*
A	LENGTH [mm]	max 4700	max 4700	max 3000	*
B	LENGTH [mm]	max 4700	max 4700	max 3000	B = L - A - C
C	LENGTH [mm]	max 4700	max 4700	max 3000	*
L (A + B + C)	TOTAL LENGTH [mm]	max 8500	max 8500	max 6000	*

Minimum length of a straight segment is 1000 mm.

- Type 3 / **Carport 240 + Back Box**
* Fill in with your data

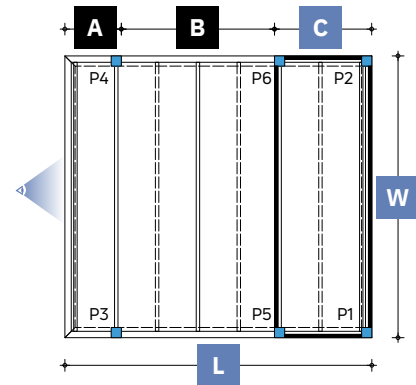
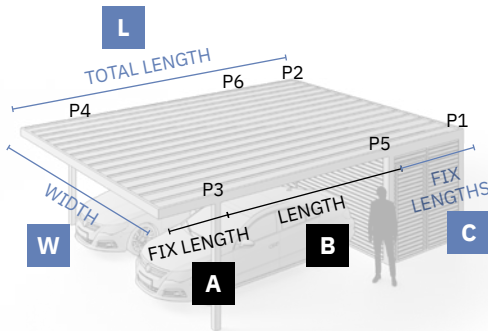

	Load capacity [kg/m ²]	100	160	240	* Your data [mm]
W	WIDTH [mm]	max 6000	max 6000	max 6000	*
A	FIX LENGTH [mm]	1300	1300	1300	1300
B	LENGTH [mm]	max 4700	max 4700	max 3000	B = L - A - C
C	FIX LENGTH [mm]	1200 or 1800 or 2400 or 3000	1200 or 1800 or 2400 or 3000	1200 or 1800 or 2400 or 3000	*
L (A + B + C)	TOTAL LENGTH [mm]	max 8500	max 8500	max 7300	*

Minimum length of a straight segment is 1000 mm.



Be careful not to exceed the **MAX** dimensions according to the selected load capacity

Soltec Carport SL

- Type 4 / **Carport 240 + Back Box**
* Fill in with your data

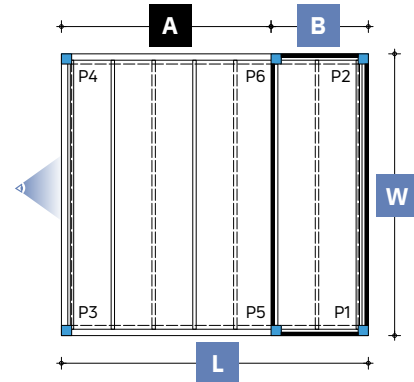
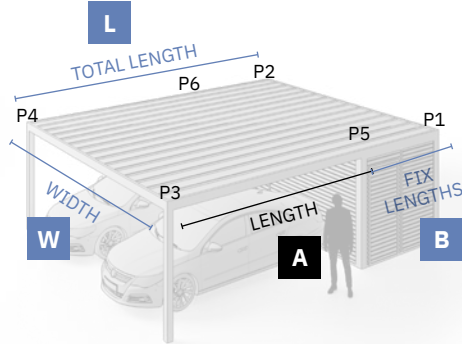

	Load capacity [kg/m ²]	100	160	240	* Your data [mm]
W	WIDTH [mm]	max 6000	max 6000	max 6000	*
A	LENGTH [mm]	max 4700	max 4700	max 3000	A = L - B
B	FIX LENGTH [mm]	1200 or 1800 or 2400 or 3000	1200 or 1800 or 2400 or 3000	1200 or 1800 or 2400 or 3000	*
L (A + B)	TOTAL LENGTH [mm]	max 7700	max 7700	max 6000	*

Minimum length of a straight segment is 1000 mm.

- Type 5 / **Carport 240 + Back Box**
* Fill in with your data

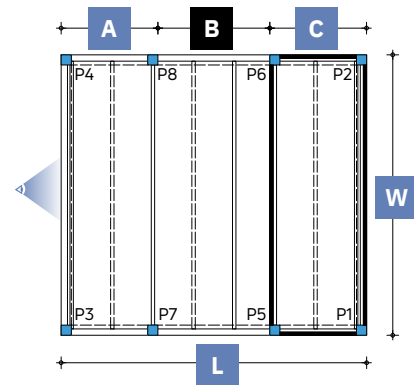
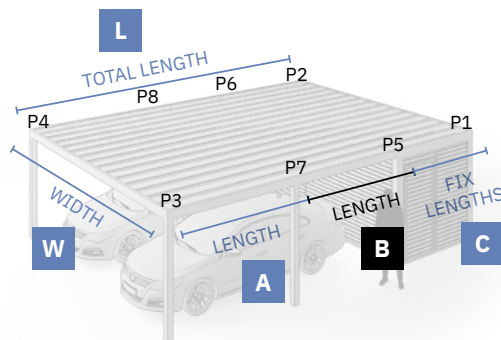

	Load capacity [kg/m ²]	100	160	240	* Your data [mm]
W	WIDTH [mm]	max 6000	max 6000	max 6000	*
A	LENGTH [mm]	max 4700	max 4700	max 3000	*
B	LENGTH [mm]	max 4700	max 4700	max 3000	B = L - A - C
C	FIX LENGTH [mm]	1200 or 1800 or 2400 or 3000	1200 or 1800 or 2400 or 3000	1200 or 1800 or 2400 or 3000	*
L (A + B + C)	TOTAL LENGTH [mm]	max 8500	max 8500	max 8500	*

Minimum length of a straight segment is 1000 mm.



Be careful not to exceed the **MAX** dimensions according to the selected load capacity

Soltec Carport SL

- Type 5 / **Carport 240 + Left Box**
* Fill in with your data

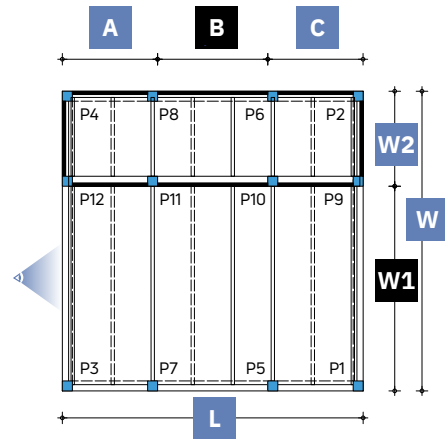
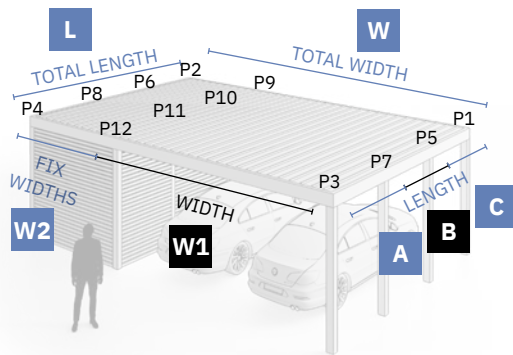

	Load capacity [kg/m ²]	100	160	240	* Your data [mm]
W (W1 + W2)	TOTAL WIDTH [mm]	max 8500	max 8500	max 8500	*
W1	WIDTH [mm]	max 6000	max 6000	max 6000	W1 = W - W2
W2	FIX WIDTHS [mm]	1200 or 1800 or 2400 or 3000	1200 or 1800 or 2400 or 3000	1200 or 1800 or 2400 or 3000	*
A	LENGTH [mm]	max 4700	max 4700	max 3000	*
B	LENGTH [mm]	max 4700	max 4700	max 3000	B = L - A - C
C	LENGTH [mm]	max 4700	max 4700	max 3000	*
L (A + B + C)	TOTAL LENGTH [mm]	max 8500	max 8500	max 8500	*

Minimum length of a straight segment is 1000 mm.

! Be careful not to exceed the **MAX** dimensions according to the selected load capacity

Soltec Carport SL

Type 5 / **Carport 240 + Right Box**
* Fill in with your data

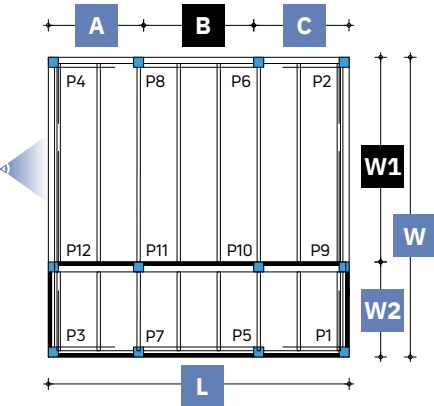
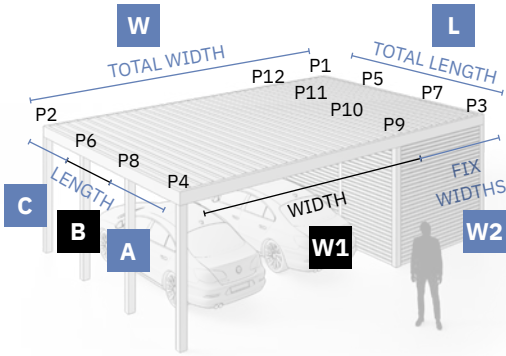

	Load capacity [kg/m ²]	100	160	240	* Your data [mm]
W (W1 + W2)	TOTAL WIDTH [mm]	max 8500	max 8500	max 8500	*
W1	WIDTH [mm]	max 6000	max 6000	max 6000	W1 = W - W2
W2	FIX WIDTHS [mm]	1200 or 1800 or 2400 or 3000	1200 or 1800 or 2400 or 3000	1200 or 1800 or 2400 or 3000	*
A	LENGTH [mm]	max 4700	max 4700	max 3000	*
B	LENGTH [mm]	max 4700	max 4700	max 3000	B = L - A - C
C	LENGTH [mm]	max 4700	max 4700	max 3000	*
L (A + B + C)	TOTAL LENGTH [mm]	max 8500	max 8500	max 8500	*

Minimum length of a straight segment is 1000 mm.

2.5 Quantity of Carport



2.6 Number and height of posts (height of post + frame)

<input type="checkbox"/> 0 posts	<input type="checkbox"/> P5	<input type="checkbox"/> P10
<input type="checkbox"/> P1	<input type="checkbox"/> P6	<input type="checkbox"/> P11
<input type="checkbox"/> P2	<input type="checkbox"/> P7	<input type="checkbox"/> P12
<input type="checkbox"/> P3	<input type="checkbox"/> P8	<input type="checkbox"/> additional post:
<input type="checkbox"/> P4	<input type="checkbox"/> P9	<input type="text"/>

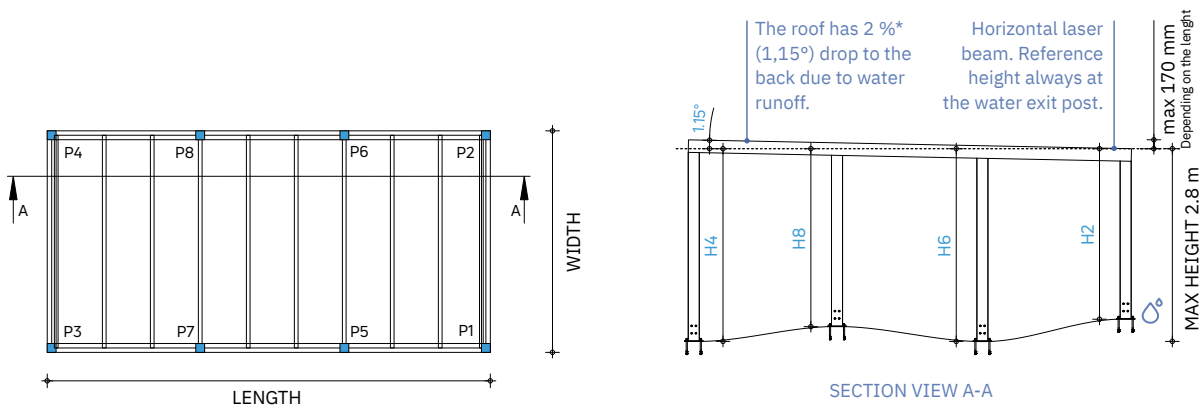

This sample image is an instructions for measurements. The actual layout of the poles for selected Carport type is shown in sections 2.2, 2.3 and 2.4. Please keep in mind that Carport has roof drop towards posts P1-P2.

2.7 Colour

Standard

STRUCTURE (profile, posts, secondary beam profile)



Non-standard Subject to additional payment.

STRUCTURE

RAL no.	Finish
---------	--------

ROOF (Insulated panel 3 cm)



Step 3 / Drawing with marked specifications

3.1 Mark water exits and power supply on top view

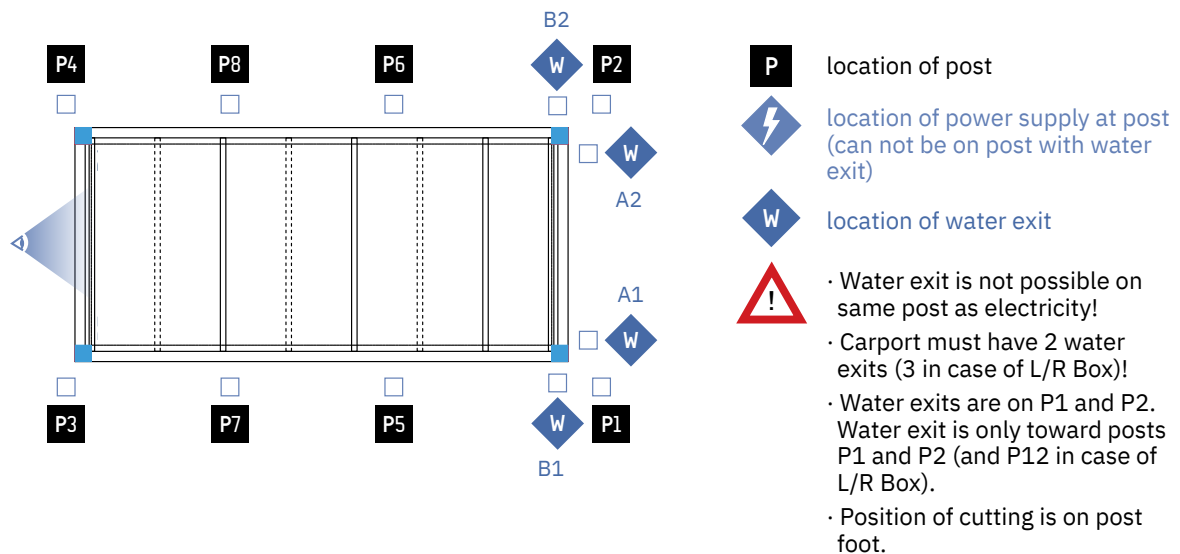

3.3 If choose Wall mounting, mark position on profiles

- P1-P2 P3-P4
 P1-P3 P2-P4

3.4 Foot mounting

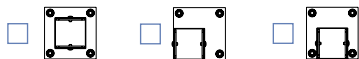

3.5 External foot mounting protection

- galvanization 130 €/pcs or
 galvanization+painting 170 €/pcs or
 inox 320 €/pcs

Step 4 / Options

4.1 Box (only for Carport)

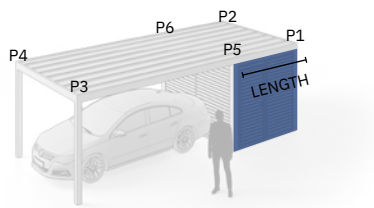

A) Length of box

- 1.2 m
- 1.8 m
- 2.4 m
- 3.0 m

B) Box Infill

- Insulated panel 3 cm
- Siberian larch wood slats 24/70
- Aluminum Expanded Metal Sheet
- Aluminium square profile 20/20

C) Colours

- If choose Insulated panel 3 cm, mark colour



- If choose Aluminium Expanded Metal Sheet, Aluminium square profile 20/20, mark colour



If choose Larche wood slats 24/70, the colour of tube 80x50 is the same as the colour of structure.

D) Quantity of doors

One door is included in price.
Additional doors are subject to
additional payment 510€ / pcs.

E) Location of the door (post nr.)

P

P

F) Right or left handed opening

R

R

L

L

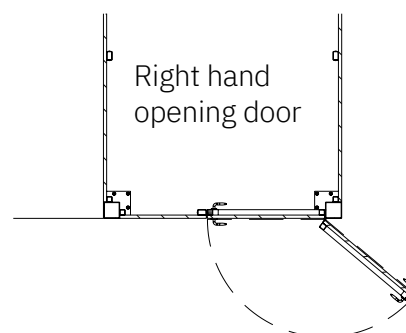
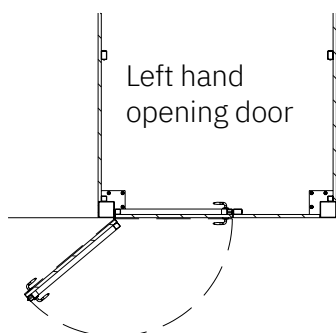

4.2 Walls*

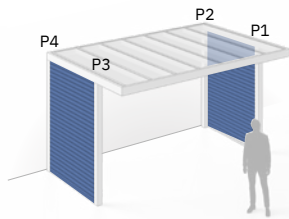
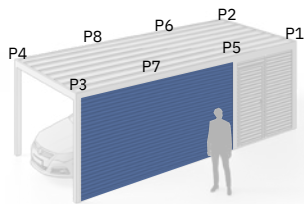

A) Position

Choose the position between posts according to your type of Carport or Glassport*

- P1-P2
- P1-P3
- P2-P4
- P3-P4
- P1-P5
- P2-P6
- P5-P3
- P6-P4
- P5-P7
- P6-P8
- P7-P3
- P8-P4

* On Glassport is possible to have walls only between posts P1-P2 and P3-P4 at the type 1, 2 and 3. Walls are not possible on type 4.

B) Wall Panels Type

- Insulated panel 3 cm
- Siberian larch wood slats 24/70
- Aluminum Expanded Metal Sheet
- Aluminium square profile 20/20

C) Colours

- If choose WALL/ISO 3, mark colour



- If choose WALL/L44 – ALU 20/20, WALL/L44 – ES, mark colour



If choose WALL / WOOD, the colour of tube 80x50 is the same as the colour of structure.

Step 5 / Accessories

LED lights integrated into the secondary beam profile

Subject to additional payment 300€/ pcs

A) Position

- first secondary beam profile (profile P1-P2)
- last secondary beam profile (profile P3-P4)

With Left or Right Box you get LED outside of the box. If you want LED in the Box, then write for LED quantity 2 instead 1. If you want 2 LED lights one secondary profile on Carport 240 or Carport 240 + BackBox, then also write for LED quantity 2 instead of 1.

B) LED length

- 0.5 m
- 1 m
- 1.5 m

C) Light colour

- RGB
- Neutral white 3200 - 5000°K
- Warm white 2200 - 3200°K

D) Controls

- 2 remote controlers including electronic (one remote control, if RGB)
- Dusk / down including electronic
- Movement sensor including electronic
- Switch

Step 6 / Water evacuation options

Submit drawing from catalogue page 25, add data of measures.

Subject to additional payment.

- Type V Type H Type P

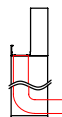

General Sales Conditions and warranty

The following terms, together with such terms as are set forth on the Price List, Order Form, Offer, Confirmation of Order or Invoice, plans, specifications or other additional terms as are approved in writing by Soltec, shall constitute the entire contract between Soltec and the Buyer. The conditions contained herein shall take precedence over any other conditions and no contrary, additional or different provisions or conditions shall be binding on Soltec unless expressly accepted by Soltec in writing. Any quotation provided by Soltec does not constitute a firm offer and may be changed or revoked at any time. Such quotation, including calculations and descriptions made or supplied by Soltec ("Quotation") shall remain Soltec's property and Buyer agrees that such information contained in the Quotation is confidential and shall not be disclosed or otherwise used without Soltec's express prior written consent. This contract replaces any other preceding agreement between the parties relating to the sale of goods or provision of services. By placing the order, the Buyer accepts in full these General Sales Conditions. By accepting such conditions the Buyer acknowledges that he has the skills, capabilities, tools and staff to install properly Soltec products, according to Soltec's instruction manual and aligned with general and local regulations and best practice standards, hence becoming an authorized reseller of Soltec products.

1. Prices

- 1.1. Prices provided on Soltec's Price List, Order Form, Confirmation of Order or Invoices are expressed in Euros. The prices do not include any applicable VAT or other taxes.
- 1.2. Any discounts for distribution and reselling of Soltec products shall be agreed in writing. Except as explicitly mentioned otherwise on Soltec's Price List, Order Form, Confirmation of Order or Invoices or as otherwise agreed upon in writing by Soltec and Buyer, the price stated on the valid Soltec's Price List, Order Form, Confirmation of Order or Invoices is net without any deductions whatsoever.
- 1.3. All additional costs, including (but not limited to) charges for freight, packing, carriage, insurance, customs duties, fees for export, transit, import and any other permits and certificates as may be necessary, shall be borne by the Buyer.
- 1.4. If charges for packing, freight, carriage, insurance, customs duties or other additional costs are separately stated on Soltec's Price List, Order Form, Confirmation of Order or Invoices and included in the price stated thereon, Soltec reserves the right to adjust its price should the costs on which such additional charges are based be modified.
- 1.5. The supply of Soltec products not included in the price list, should take place only after Soltec has provided a quote directly on the customer's request.
- 1.6. Soltec reserves the right to change prices in case of altered quantity, colour, size, or any other facts that are the basis for price calculation.
- 1.7. The Buyer may not legally claim the right of retention of payment of the price or of the delivery of the goods, and he cannot make any exceptions or raise any counterclaims, unless Soltec substantially breaches its obligations, despite a written warning of the Buyer, and does not provide adequate guarantee.

2. Taxes and duties

- 2.1. Unless otherwise agreed in writing, Soltec's prices are exclusive of any federal, state or local taxes or other taxes which may now or hereafter be applicable to the transaction, the products, their sale, their value or their use or to any services performed in connection therewith.
- 2.2. The Buyer agrees to pay or reimburse any such taxes which Soltec or Soltec's subcontractors or suppliers are required to pay. Buyer shall furthermore be responsible for the import of the products into the country of delivery, if delivered outside of Slovenia.

3. Sales promotion

- 3.1. The Buyer, whereas this is a reseller or distributor to Soltec, agrees to use his best efforts to promote the sale of the products within his territory in and shall protect Soltec's interests with the diligence of a responsible businessman.
- 3.2. The Buyer shall provide and maintain an adequate organisation to promote sales and, where appropriate, after-sale service, with all necessary means and personnel, in order to ensure the fulfilment of his obligations throughout the territory.
- 3.3. The Buyer undertakes to strictly conform to the Soltec's marketing policy, especially with regard to the choice of products and their performance and the distribution channels, which must in any case be adequate for the trademark image of Soltec.
- 3.4. The Buyer shall take part, at his own expense, in the main fairs and exhibitions in his territory. Soltec reserves however the option to participate directly to any fair or exhibition in the territory and in such case the parties will bear their respective expenses.
- 3.5. The Buyer shall be responsible for all advertising necessary to adequately promote the Products within the territory. He agrees to regularly advertise and publicise the products as well as Soltec's name and trademarks in the territory. Any advertising and promotion regarding Soltec and/or the products shall be in strict accordance with the indications given by Soltec, in order to warrant that it conforms in all respects to the company's image and marketing policies.
- 3.6. Any advertisement materials regarding the products issued by the Buyer, including their presentation through Internet, shall strictly conform to Soltec's guidelines and must receive the prior approval of Soltec. The costs of all advertising and sale promotion activities shall, unless otherwise agreed, be borne by the Buyer.
- 3.7. The Buyer may advertise the products and/or his activity as reseller or distributor of Soltec's products on Internet, provided he informs Soltec so that the latter can check that such advertising conforms to his trademark image. The costs of such advertising will be borne, unless otherwise agreed, by the Buyer.

4. Soltec's support to the Buyer

- 4.1. Soltec shall provide the Buyer, at cost price, with all documentation relating to the products (brochures, price-lists, catalogues, etc.) needed by the Buyer for carrying out his commitments under the contract.
- 4.2. If such documentation needs to be translated in the language of the Buyer's country or otherwise adapted to the requirements of such country, the Buyer will carry out such translations or adaptations at his costs.
- 4.3. Unless otherwise agreed, any documentation expressly made for the Buyer's country shall be at the Buyer's charge.
- 4.4. At the end of this contract the Buyer shall return to Soltec any advertising material or other documentation provided to the Buyer which is still in the Buyer's possession.

5. Buyer's obligations to report market conditions

- 5.1. The Buyer shall with due diligence keep Soltec informed about his activities, market conditions and the state of competition (e.g. features and prices of competing products, marketing actions of competing firms, etc.) within his territory. He shall furthermore answer any reasonable request for information made by Soltec.
- 5.2. The Buyer shall further keep Soltec informed about the laws and regulations in force in the territory to which the products must conform (e.g. labelling, technical specifications, safety requirements, etc.) and shall require in the name and on behalf of Soltec any authorization which might be necessary for distributing or selling the products in the territory.
- 5.3. The Buyer shall further send an annual report on his activities.

6. Terms of Payment/Reservation of Title

- 6.1. Except as otherwise provided on the face of Soltec's Invoices or Confirmation of Order, payment shall be due all in advance prior to dispatching of products.
- 6.2. If Buyer does not observe the agreed dates of payment, Buyer shall, without any requirement of a formal notice from Soltec, pay interest to Soltec on overdue amounts from the date(s) due, at the rate of eight (8) percent per annum or any interest rate that is due on the basis of applicable local law. Payment of such interest does not release Buyer from its obligation to make payments when due.
- 6.3. Buyer shall not be entitled to any setoff of claims or retention rights ("Counterclaims"), unless such Counterclaims are based on claims or rights against Soltec that are either: (a) undisputed or (b) legally binding with final force and effect and non-appealable.
- 6.4. If, in the judgment of Soltec, the financial condition of Buyer, at any time during the manufacturing period or at the time the products are ready for dispatch, does not justify the continuance of the work to be performed by Soltec hereunder or the terms of payment specified, Soltec may require full payment in advance as well as in the event of Buyer's bankruptcy or insolvency or in the event any proceeding is brought against Buyer, voluntarily or involuntarily, under the bankruptcy or any insolvency laws.
- 6.5. Soltec shall be entitled to cancel any order then outstanding at any time during the period allowed for filing claims against the estate and shall receive reimbursement for its proper cancellation charges and expenses.
- 6.6. Soltec's rights under this paragraph are in addition to all rights available to it at law or in equity. Orders being placed and relevant terms of payment shall remain as specified, if the transportation, delivery, installation, commissioning or taking possession of the products or services is/are delayed or prevented due to reasons beyond Soltec's control, or if parts are missing, but to be supplied within a reasonable period of time.
- 6.7. In the event that any payment or payments are not made by Buyer in accordance with the terms or as may be otherwise agreed upon, Soltec, at its option, may terminate the underlying contract, and be entitled to claim damages.
- 6.8. The products shall be identified in the specific contract and risk of loss shall pass to Buyer when the products are placed in the hands of a carrier. Title to the products shall not pass to Buyer until all the amounts due to Soltec in respect of the delivery, including any interest and costs, have been paid.
- 6.9. Goods can only be returned with the express prior written approval of Soltec. The cost of transporting and processing returned goods (incoming goods, inspection including packaging, storage, etc.) will be borne by the Buyer.

7. Production Time/Delivery Time

- 7.1. Soltec products are intended Ex-Works EXW Incoterms 2010 (International Commercial Terms), company seat: Soltec d.o.o., Obrtna ulica 9, Dobova, Slovenia.
- 7.2. Soltec shall not be liable for any loss or damage to Buyer resulting from any delay in delivery.
- 7.3. Production time for any Soltec products starts when the Buyer has confirmed the offer in writing and technical plans and has provided advanced payment according to these General Sales Conditions.
- 7.4. The due date(s) on Soltec's Price List, Order Form, Confirmation of Order or Invoices are approximate and shall be reasonably extended if:
 - (a) information required by Soltec from Buyer to execute the order is not received in a timely manner;
 - (b) if changes to the Order are agreed upon by Soltec and Buyer;
 - (c) Soltec is not able to make timely production by reason of hindrances which, despite due care, Soltec cannot avoid (inclusive of those occurring in the works of its major suppliers or third parties), such as epidemics, pandemics, act of civil or military authority, mobilization of armed services, war, riots, strikes, boycotts, picketing, lock-outs or other disturbances, machinery breakdowns, accidents, labor conflicts, delayed or deficient

delivery of necessary raw materials or semi-manufactured and manufactured products, the need to scrap important components due to defective casting, official or other measures of whatever kind, transport difficulties, natural catastrophes, and any acts of God;

or (d) if Buyer or a third party is behind schedule with work which it has to carry out, or late in fulfilling its contractual obligations (including, but not limited to failure by Buyer to observe the terms of payment).

- 7.5. Soltec shall not be liable for any loss or damage to Buyer resulting from any delay in production, except as noted below.
- 7.6. Buyer shall be entitled to cancel an order already being placed or refund of advanced payments or damages for delay in production, only if it can prove that said delay has been caused by direct fault of Soltec and that Buyer has suffered a loss as a result of such delay.
- 7.7. Notwithstanding anything to the contrary, damages for delayed production shall in no cases exceed one half (1/2) of one percent (1%) for every full week of delay and shall in no case whatsoever exceed a total of five percent (5%) of the sales price Ex-Works of that portion of the supplies which have been delayed. In no event shall any damages be due to Buyer for the first two (2) weeks of any delay.
- 7.8. It is the Buyer responsibility to take over the goods upon delivery and to inspect them. The Buyer will sign the bill of delivery with acknowledgment of receipt stating its name. The Buyer can authorize someone else to represent them in order to take over the goods.

8. Modification of Orders

- 8.1. Orders being placed may be revoked or modified by the Buyer only with written permission of Soltec. Changes to the original order being placed have to be communicated in writing and are subject to Soltec's acceptance. When the production for carrying out the order has already started prior to the modification or revocation of the order, the Buyer shall be charged with the cost of the material purchased or produced and which can no longer be used in relation to the modified or revoked order. Changes to any given order that is approved by Soltec automatically leads to an extension of the production time of the same order.

9. Soltec's Trademarks - Unfair competition - Confidentiality

- 9.1. The Buyer acting as a reseller or distributor to Soltec shall use Soltec's trademarks, trade names or any other symbols (hereafter «Trademarks»), but only for the limited purpose of advertising the sale of the products and identifying himself as a reseller or distributor of Soltec, such use of the Trademarks being made in Soltec's sole interest.
- 9.2. Any use of the Trademarks on advertising materials or on any other materials addressed to third parties or on Internet (especially on the Buyer's web site, if any) shall require the prior written consent of Soltec.
- 9.3. The Buyer agrees neither to register, nor to allow or favour the registration by third parties of any of the Trademarks (nor of any trademarks, trade names or symbols which are confusingly similar to the Trademarks), in the territory or elsewhere.
- 9.4. He furthermore agrees not to include the Trademarks in his own trade or company name.
- 9.5. The Buyer shall inform the Supplier, as soon as he gets notice of it, about any acts of unfair competition or infringement of Soltec's Trademarks or other intellectual property rights (e.g. patents) by third parties and concerning the Products. He shall also assist Soltec in defence of his rights in the territory.
- 9.6. The Buyer shall not reveal either during the currency of this contract or after its termination or expiration Soltec's trade or commercial secrets or other confidential information (e.g. technical data regarding the products, discount policies, general conditions of sale, warranty conditions, etc.) that has come to his knowledge through his activities as reseller or distributor of Soltec, and agrees not to use such secrets or confidential information for purposes other than those of the present contract.

10. Warranty

- 10.1. Soltec warrants that the products will adhere to Soltec's description and that the specifications will be the kind and quality described in the contract and will be free of defects in workmanship or material. Should any failure to conform to this warranty appear on the date of delivery, Soltec shall, in complete fulfillment of its liabilities under this warranty, if given written notice by Buyer, correct by repair or replacement, at discretion of Soltec.
- 10.2. The Buyer acknowledges that there may be deviations in the colour of the delivered goods compared to the sample shown in Price List, Soltec's documentation or presented photos or material, and that slight colour deviations may occur when the surface is enameled. Such deviations do not give the Buyer the right to any claim or demand for the annulment of agreement or to refuse delivery and/ or payment of the products.
- 10.3. Soltec can arrange the transport of the products upon request, on behalf of the Buyer and at his risk and costs.
- 10.4. Buyer shall be obliged to inspect the Products upon delivery: inspection shall regard amongst others appearance, status, quantity and size of products. Within ten (10) days after delivery and before installation, the Buyer will report to Soltec about any visible defects or damages or non-conformity of parts and products, marking them on the delivery note and report them to Soltec.
- 10.5. Defects or damages or non-conformity, including any possible missing parts, which are reported at a later date will not be accepted by Soltec and, except for any latent defects, any failure to inspect the products within this period shall be deemed as an acceptance of the products.
- 10.6. Date of delivery starts when the products leave Soltec's facility on an Ex-Works basis. Latent defects shall be sent to Soltec by the Buyer via registered mail or the official e-mail address immediately after discovery and no later than one (1) month from delivery. Any complaints made at a later date will not be accepted.
- 10.7. Buyer shall fully cooperate with Soltec and make the products available for inspection if so requested by Soltec, by supplying photographic evidence and/or returning defective components on the address of Soltec. In no event will Soltec be responsible for providing access to the defective part or parts or for the disassembly, removal, or reinstallation of the products or components thereof.
- 10.8. The warranty contained in this section will terminate immediately if Buyer or a third party undertakes inappropriate or improper use, modification or repairs or if Buyer, in case of a defect, does not immediately take all appropriate steps to mitigate damages and notify Soltec in writing of its obligations to remedy such defect.
- 10.9. Correction of nonconformities in the manner and for the period of time provided above shall constitute fulfillment of all liabilities of Soltec to the Buyer, whether based on contract, negligence or otherwise, with respect to such products. The warranty provided for in this Section shall not be applicable if Buyer is in arrears with any payments due.
- 10.10. Returns of goods, for any reason due, must first be authorized by Soltec and, unless otherwise agreed, sent to the headquarters of Soltec at the expenses of the buyer.
- 10.11. Soltec assumes no responsibility or liability for any accidents caused to third parties or direct and indirect damages to property during the installation phase, as well as any direct and indirect damages to goods caused by improper installation.
- 10.12. Soltec shall not be liable in any civil, criminal and/or administrative proceedings for the damage caused by unauthorized use of the products and/or following their use outside the parameters of performance specifically provided for each specific type of product.
- 10.13. Warranty of Soltec's product is applicable as follows:
- 10.14. The Buyer acknowledges and accepts that the value of the components that have to be replaced under warranty because recognized as originally defective, decreases in time, with the exception of motors and automation (control units, transformers and other possible electronic parts), which is calculated according to the following depreciation parameters:
1st and 2nd year 100% of the value;
3rd year 60% of the value;
4th year 40% of the value;
5th year 20% of the value.
- 10.15. The warranty is limited to the repair or replacement at the expense and choice of Soltec of the parts affected by faults and/ or defects and/or non-compliant with the advised quality.
- 10.16. The customer is not entitled to claim any other compensation or damages from Soltec, such as installation costs, travel expenses and salaries. Installation and maintenance of goods must always be performed in accordance with the Installation manual and User manual instructions.
- 10.17. Furthermore, resellers of Soltec products are responsible to perform the installation as well as any further maintenance as needed and instruct the final user according to the Instructions Manual.
- 10.18. Qualified personnel must be appointed to carry out any electrical connections, grounding and any intervention on the electrical systems and any interventions carried out by unauthorized personnel invalidate the warranty relieving Soltec from any liability arising in any way.
- 10.19. Warranty cannot be claimed in case of damage to goods from improper use and / or inadequate maintenance. Incorrect use can be understood as any abuse, dangerous handling, incorrect or compulsive use and improper repair or modification.
- 10.20. Soltec's warranty does not apply in case of damages caused during harmful environmental conditions, riot, civil commotions or war, transport or storage, errors caused by unauthorized repairs by third parties and in case for any malfunctions or damages caused by parts that have not been approved by Soltec's technical department.
- 10.21. The warranty also does not apply in the event of improper use or installation, in case of damages caused by painting, drilling, corrosion, saltiness, temporary or permanent change in environmental factors, installation for purposes others than the ones the product was designed for. Soltec shall not be liable for direct, indirect, incidental or consequential damages such as, but not limited to, loss of profits or revenue, damage or loss of other property or Products or cost of capital.
- 10.22. The remedies of Buyer set forth herein are exclusive and Soltec's liability with respect to any contract or sale or anything done in connection therewith, whether in contract, in tort, under any warranty, or otherwise, shall not, except as expressly provided herein, exceed the cost of the Products or part on which such liability is based.

11. Governing law

- 11.1. This contract shall be governed by and construed in accordance with the laws of the Republic of Slovenia, without any regard to this country's or any other jurisdiction's conflicts of law principles.
- 11.2. Buyer and Soltec stipulate and agree that the court of competent subject matter jurisdiction for the city of Krško, Slovenia shall have jurisdiction and both parties agree that such venue is proper in such courts for all actions or proceedings with respect to these General Sales Conditions.

Carport		Other product / projects Blinds, Roller Blinds, Sliding / folding panels, Sunbreakers
Structure	7 Years	2 Years
Led lights	1 Year	
Electronic parts	2 Years	
Fabrics	2 Years	
Other parts and components	2 Years	



Our outdoor products



Soltec **Bioclimatic Pergola**

We produce innovative bioclimatic pergolas that are characterised by technical perfection, aesthetic appearance, and functionality. We strive to ensure that technological progress and sustainability go hand in hand. We want to leave our mark, so we like to play with different solutions. The latest of these is the cabrio pergola, where the slats fold to the side and give you an unobstructed view of the sky.

Soltec **Carport**

The Soltec carport, with its elegant lines, blends in with the modern architecture of the house, while boasting incredible reliability. It is made of inox and aluminium. But we haven't stopped there. We know there's always a shortage of storage space around the house, so you can add a shed to your new carport for tyres, tools, bikes, and everything you've never been able to stow away before. And for owners of electric vehicles, there's the Solar Pack, which turns your carport into a self-sustaining charging station.



Soltec **Multiport**

The Soltec multiport is a universal canopy that allows you to design it your way. You can use glass, aluminium, or greenery for the roof. Glassport, aluport and greenport are all solutions that allow you to have a unique canopy at the entrance, on the balcony, on the terrace, or wherever you need protection from the weather. The materials and design match to both the carport and the bioclimatic pergola for a uniform and tidy look around the home.

Soltec **Outdoor Kitchen**

Soltec outdoor kitchens are designed to seamlessly blend function and aesthetics. Imagine expansive work tops for prepping culinary masterpieces, high-quality equipment built to last through any weather, and all of it wrapped in a design that complements your outdoor space. Craft your ideal culinary haven with our vast selection of worktops, ALU composite claddings, handles and add state of the art equipment and accessories.



Soltec **Waste enclosure**

The Soltec waste enclosure is a commitment to sustainability, functionality, and style. Each element is thoughtfully designed to aesthetically complement their basic functionality. High-quality, weather-resistant materials ensure a long life and easy maintenance. Our commitment to perfection is reflected in the thoughtful design of our waste enclosures, which not only integrates functionally into your everyday life, but also aesthetically complements your pergola, carport and other Soltec products.





7-year warranty
on the structure of
Carport

7 year warranty, made in EU, fully certified

INOX
STAINLESS
STEEL



To ensure optimal quality, Carport is in accordance with the following EN standards:

EN 1990:	Basis of Structural Design
EN 1991:	Actions on structures
EN 1991-1-1:	General actions - Densities, self-weight, imposed loads for buildings
EN 1991-1-3:	General actions - Snow loads
EN 1991-1-4:	General actions - Wind actions
EN 1991-1-5:	General actions - Thermal actions
EN 1993:	Design of steel structures
EN 1998:	Design of structures for earthquake resistance
EN 1999:	Design of aluminium structures
EN 1090:	Execution of steel and aluminium structures
EN 13659:	Shutters and external venetian blinds - Performance requirements including safety
EN 13561:	External blinds and awnings. Performance requirements including safety
EN 60335-1:	Household and similar electrical appliances - Safety - Part 1: General requirements
EN 60335-2-97:	Household and similar electrical appliances. Safety. Particular requirements for drives for rolling shutters, awnings, blinds and similar equipment

soltec
More life.

SOLTEC d.o.o.
Obrtna ulica 9
8257 Dobova
Slovenia, EU

+386 7 45 22 126
+386 51 650 850
info@soltec.si
www.soltec.si