

ARCHWAY — RODOLFO DORDONI 2023

1—
5



The Archway sideboard is a sleek and modern design by Rodolfo Dordoni, one of the stars of exploration into the world of design by Molteni&C, and the latest addition to the company's extensive offering of living systems. Archway owes its striking form to its stylish and modern silhouette. The sideboard's door is embellished with a slightly cantilevered metal profile with respect to the top, which traces the handle with a rigorous line. In the centre, an open compartment with a drawer provides a central volume, creating a sense of movement. The clean lines of the sideboard and the play of thicknesses between the structure and the doors give it a minimal and contemporary look and feel. Archway is available in two lengths, 242 and 276 cm, while the plinth is 18 cm in height and hides an integrated drawer, allowing for added versatility within the design. Beautifully finished on both sides, it can be placed against a wall or in the centre of a room as a dividing element. The sideboard can be customised in all the glossy lacquered shades available in the Molteni&C catalogue, including the new pine green and almond white colours, allowing for infinite possibilities to easily be combined with any interior palette. The top, in contrast with the structure, is available in wood or marble. Among the essences are the gold-toned limba and the coffee oak, recognisable for its intense contrasting streaks. The marble proposal ranges from calacatta, sahara noir to black marquina in matte or glossy polyester versions, offering a wide range of options to customise the aesthetic. The integrated handles are the epitome of attention to detail: cut at a 45-degree angle, they give a unique and precious look. Specially designed hinges are inserted into the shoulder of the sideboard itself. The interior shelves can be in wood or smoked glass. The versatile Archway is perfect for the dining or living area. A unique and stunning piece of furniture that achieves aesthetic originality through technological innovation, with no detail left to chance. The sideboard's design is a perfect blend of style, functionality, and personalisation, making it an excellent addition to any living space.

DATASHEET

REGISTERED
DESIGN

IX.2023

NOTES

- ▶ No reductions of any kind or changes to the types are possible.
- ▶ The base is always made with two fully extractable drawers with mechanical pressure opening.
- ▶ The upper top and the top above the open compartment drawer are always made with the same finish.
For marble top, specify the type of finish: matt or glossy polyester.
- ▶ The cupboards can be accessorised with:
 - LED lighting system.
 - drawer bottom kit in Eco Skin.

Molteni & C

2—
5

finishes	glossy lacquer colours	coffee oak / limba	Sahara noir / calacatta / black marquina	smoked glass
components				
doors / side panels / back panel				
upper top and open compartment drawer top			*	
base with drawers				
open compartment drawer front				
internal shelves				

Handle profile: glossy black nickel.

Drawer interior: grey saffiano.

Under top: black melamine.

Bottoms: Grey Eco Skin.

* marbles available in matt or glossy polyester finish

DATASHEET

REGISTERED
DESIGN

IX.2023

MODULARITY

Molteni & C

3—
5

W 242 - 95 1/4"

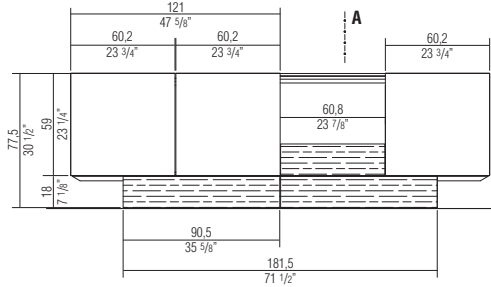

W 270 - 106 1/4"

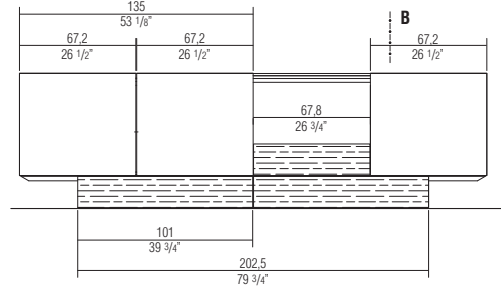

Inside

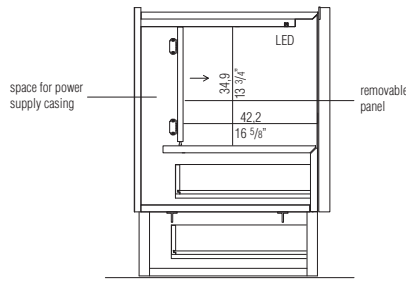
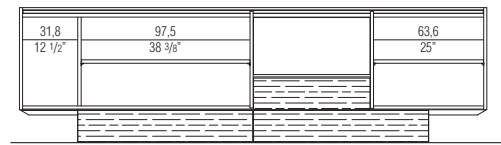
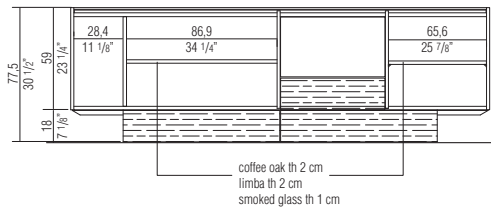

section A

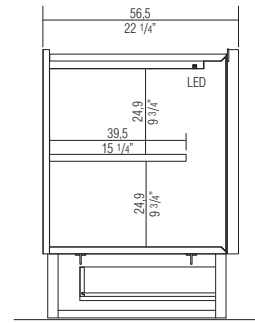

section B

Optional lighting system

The system must be always connected to a controlled outlet.
Remote control and DALI kit are not available.

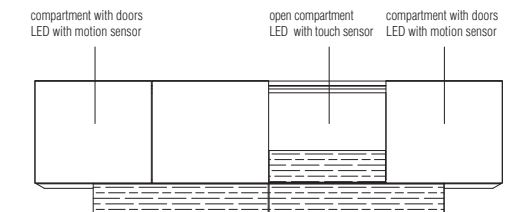

DATASHEET

REGISTERED
DESIGN

IX.2023

TECHNICAL INFORMATION

DOORS, BACK, SIDE PANELS, BASE

Chipboard panel with melamine facing painted in the Molteni&C colour range.
Door handle profile in painted extruded aluminium.

UPPER TOP, BASE, INTERNAL SHELVES, DRAWER AND OPEN COMPARTMENT TOP

Chipboard panel coated with an coffee Oak or Limba wood veneer.
Structural reinforcement on a base in painted metal.

MARBLE TOP

Marble with matt finish or glossy polyester.

GLASS SHELVES

Smoked crystal th 8 mm, tempered.

UNDER TOP, BASE BOTTOM AND DRAWER INTERIOR

Chipboard panel with melamine facing.

Molteni&C

4—

5

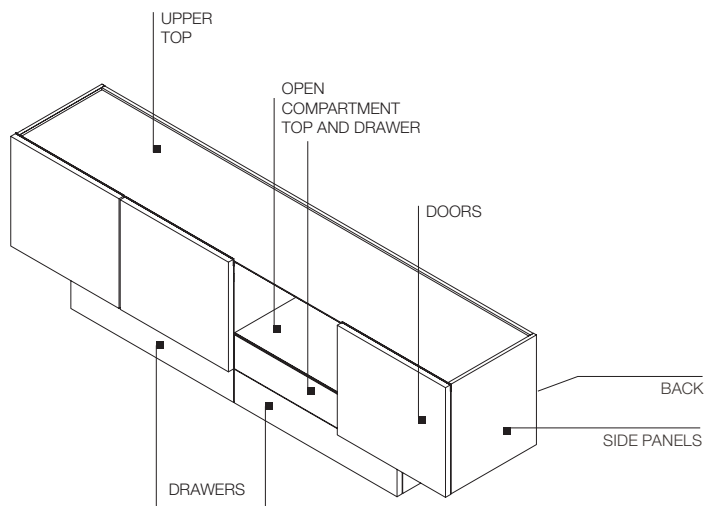

DATASHEET

REGISTERED
DESIGN

IX.2023

DIMENSIONS

cupboards

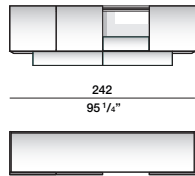

MA07/24



56,5
22 1/4"

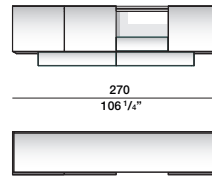

MA07/27

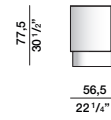

56,5
22 1/4"

Molteni & C

5—
5

internal shelves

for cupboard
W 242



RI07/24



RI24

for cupboard
W 270



RI07/27



RI27

lighting system

for cupboard W 242
EIL07/24

for cupboard W 270
EIL07/27

kit Eco Skin bottom

n. 1 W 56,3 D 37,6
 n. 2 W 81,7 D 37,6

n. 1 W 63,3 D 37,6
 n. 2 W 92,2 D 37,6

for cupboard W 242
CEK24

for cupboard W 270
CEK27

DATASHEET

REGISTERED
 DESIGN

IX.2023