

newline

**Lyra (Q series)
User Manual**

V1.0

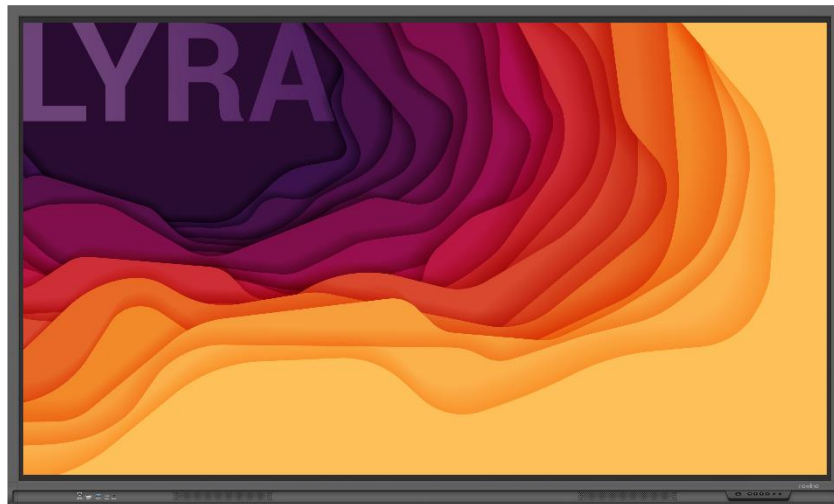

Contents

- About This Document 4**
- Safety Instruction..... 5**
- 1 Overview..... 8**
 - 1.1 Introduction..... 8
 - 1.2 Parts..... 8
 - 1.3 Ports..... 11
 - 1.4 Front Buttons 13
 - 1.5 Remote Control 14
- 2 Installation Guide..... 17**
 - 2.1 Safety Precautions 17
 - 2.2 Installation Precautions..... 18
 - 2.3 Installation 20
 - 2.4 Installing the OPS (Optional)..... 21
 - 2.5 Installing Newline Assistant..... 22
 - 2.5.1 Introduction..... 22
 - 2.5.2 Installation..... 22
- 3 Getting Started 23**
 - 3.1 Power On 23
 - 3.2 Power Off..... 24
 - 3.3 Calibration 25
- 4 Operating the Touch Screen..... 28**
 - 4.1 Profile Logon 28
 - 4.2 Home 30
 - 4.3 Sources 35
 - 4.4 Preview window..... 35
 - 4.5 OPS 36
 - 4.6 Screen Sharing 36
 - 4.7 Whiteboard..... 37
 - 4.7.1 Whiteboard Functions..... 39
 - 4.7.2 Page Operations..... 48

4.7.3 Whiteboard Setting.....	49
4.8 Annotation.....	52
4.9 File Management.....	55
4.9.1 File Viewer Page.....	55
4.9.2 File Preview.....	56
4.9.3 File Search.....	56
4.9.4 File Filtering.....	56
4.9.5 New Folder.....	57
4.9.6 File Operation.....	57
4.9.7 File Name.....	58
4.10 Browser.....	58
4.11 Apps folder.....	59
4.12 Add Shortcut.....	60
4.12.1 Add Shortcuts to Home Page.....	60
4.12.2 Add Quick Start Windows Programs in Smart System.....	63
4.13 Automatically Power Off.....	65
4.14 System Settings.....	65
4.14.1 Network Settings.....	65
4.14.2 Language and Input.....	66
4.14.3 Date and Time Settings.....	67
4.14.4 Storage.....	69
4.14.5 Applications.....	70
4.14.6 Display & Theme.....	70
4.14.7 Tool Bar.....	71
4.14.8 Input and Output Setting.....	72
4.14.9 Power Setting.....	72
4.14.10 Screen Eye Filters.....	75
4.14.11 System.....	76
5 Quick Setting Menu.....	81
6 Serial Port Control.....	83
7 FAQs & Troubleshooting.....	90
8 Specifications.....	93
9 More Information.....	96

Welcome to the world of Newline

Thank you for choosing the Q series Interactive Flat panel display. Please use this document to get the most out of your screen.

This device complies with part 15 of the FCC Rules. Operation is subject to the following two conditions: (1) This device may not cause harmful interference, and (2) this device must accept any interference received, including interference that may cause undesired operation.

NOTE 1: This equipment has been tested and found to comply with the limits for a Class B digital device, pursuant to part 15 of the FCC Rules. These limits are designed to provide reasonable protection against harmful interference in a residential installation. This equipment generates, uses, and can radiate radio frequency energy and, if not installed and used in accordance with the instructions, may cause harmful interference to radio communications. However, there is no guarantee that interference will not occur in a particular installation. If this equipment does cause harmful interference to radio or television reception, which can be determined by turning the equipment off and on, the user is encouraged to try to correct the interference by one or more of the following measures:

- Reorient or relocate the receiving antenna.
- Increase the separation between the equipment and receiver.
- Connect the equipment into an outlet on a circuit different from that to which the receiver is connected.
- Consult the dealer or an experienced radio/TV technician for help.

NOTE 2: Any changes or modifications to this unit not expressly approved by the party responsible for compliance could void the user's authority to operate the equipment.





The symbol of the crossed out wheeled bin indicates this product should not be placed in municipal waste. Instead, dispose of waste equipment by taking it to a designated collection point for electrical and electronic equipment recycling.



About This Document





This document describes multiple functions, instructions, and notes about the product.





Symbols are used in this document to indicate operations that need particular attention. The symbols are defined as follows:





 NOTE	Provides additional information to supplement operation in the main text.
 TIP	Provides tips for operation.
 CAUTION	Indicates a potentially hazardous situation that, if not avoided, could result in equipment damage, data loss, performance deterioration, or unanticipated results.
 WARNING	Indicates a hazard with risk that, if not avoided, could result in death or injury.

Safety Instruction

For your safety, please read the following instruction before you use the product. Serious injury or property damage may be caused by improper operations. Do not try to repair the product on your own.

 WARNING	
	<p>Disconnect the product from the power supply immediately if major failures occur.</p> <p>Major failures include the following:</p> <ul style="list-style-type: none"> • If smoke, a peculiar smell or an abnormal sound is discharged from the product. • No image or sound is displayed, or the image error occurs. <p>In the preceding scenarios, do not continue to use the product. Disconnect power supply immediately and contact professional staff for troubleshooting.</p>
	<p>Do not drop any liquids, metal, or anything combustible onto the product.</p> <ul style="list-style-type: none"> • If any liquids or metal are dropped onto or into the product, power off the product and disconnect the power supply. Then contact professional staff for solutions. • Pay attention to children when they are close to the product. <p>Put the product on a stable surface.</p> <p>An unstable surface includes, and is not limited to, an inclined plane, a shaky stand, desk or platform, that might cause the product to turnover and be damaged.</p>
	<p>Do not open the panel or change the product on your own.</p> <p>High voltage components are installed in the product. When you open the panel, high voltage, electric shock, or other dangerous situations may occur.</p> <p>If inspection, adjustment, or maintenance is required, contact the local distributor for help.</p>
	<p>Use the provided power supply.</p> <ul style="list-style-type: none"> • To prevent the product from being damaged, do not use any types of power cables other than the one provided with the product. • Use a three-wire socket and ensure that it is properly grounded. • Pull out the power plug from the socket if the product is not used for a long period. <p>Clean the power plug regularly.</p> <ul style="list-style-type: none"> • Fire or electric shock may be caused if the product is powered on while you are cleaning. • Pull out the power plug before cleaning it with a dried cloth. <p>Power output port is 5V/2A.</p> <p>The voltage/current of the rear power output port is 5V/2A (maximum). Purchase the power code/AC adapter according to customer needs. The port can be used for the Newline X10D Android box. Please do not connect any products with different power requirement. Otherwise, it may cause damage to products or fire.</p>

 WARNING	
	<p>Do not put items on the top of the product.</p> <ul style="list-style-type: none"> • Do not put items, such as a container for liquid (a vase, flowerpot, cosmetics, or liquid medicine) on the top of the product. • If any water or liquid is spilled on the product, the product may short circuit and cause fire or electric shock. • Do not walk on or hang any items on the product.
	<p>Do not install the product in an improper place.</p> <ul style="list-style-type: none"> • Do not install the product in humid places, such as the bathroom, the shower room, near windows, or outdoor environments that experience rain, snow, or other harsh weather. Avoid installation near hot spring vapor. The preceding environments may cause faults in the product or electric shock under extreme conditions. • Do not put an exposed fire source, such as a lit candle, on the product.
	<p>Pull out the power supply during thunderstorms.</p> <ul style="list-style-type: none"> • Do not touch the product during a lighting storm, you may experience an electric shock. • Install or place components that supply high enough voltage to cause personal injury out of the reach of children.
	<p>Do not touch the power cable with wet hands.</p>

 CAUTION	
	<p>Do not install the product in high temperature environments.</p> <ul style="list-style-type: none"> • Do not install the product near a heat source, such as a radiator, a heat reservoir, a stove, or other heating products. • Do not expose the product to direct sunlight, which may cause high temperatures and subsequent faults in the product.
	<p>When transporting the product:</p> <ul style="list-style-type: none"> • Pack the product for transport or maintenance by using the cartons and cushioning material provided with the product. • Move the product vertically during transport. The screen or other components are easily broken if the product is moved in an improper way. • Before you move the product, disconnect all external connections and separate all topple preventing products. Move the product carefully to prevent it from being hit or squeezed, especially the screen, which may cause injury if broken.
	<p>Do not cover or block up any vents on the product.</p> <ul style="list-style-type: none"> • Any overheated components may cause fire, damage the product, and shorten the service life. • Do not lay the product down in a way where the venting surface will be covered.



CAUTION

	<ul style="list-style-type: none"> • Do not install the product on carpet or cloth. • Do not use a cloth, such as table cloth, to cover the product.
	<p>Keep the product away from the radio.</p> <p>The product complies with the international EMI standard to prevent radio interference. However, interference may still exist and cause noise in the radio. If noise occurs in the radio, try the following solutions.</p> <ul style="list-style-type: none"> • Adjust the direction of the radio antenna to avoid the interference from the product. • Keep the radio away from the product.
	<p>If the screen glass is broken or falls off:</p> <ul style="list-style-type: none"> • Keep all personnel 10 feet away from the screen to ensure safety. • Do not perform any installation or disassembly while the screen glass is broken or has fallen off.
	<p>Use the battery correctly.</p> <ul style="list-style-type: none"> • Galvanic corrosion, electric leakage, and even fire may be caused by improper battery usage. • It is recommended to use the designated type of battery and install the battery by the correct electrodes (positive and negative). • Do not install and use a new battery with a used one. • Take out the battery if the remote control is not used for a long period. • Do not expose the battery to overheated environments, such as sunlight or heat sources. • Dispose of the used battery based on your local regulations.
	<p>Do not damage the power cable.</p> <ul style="list-style-type: none"> • Do not damage, change, twist, bend, or forcibly drag the power cable. • Do not put weights (such as the product itself) on the power cable. • Do not forcibly drag the cable when you pull out the power plug. If the power cable is damaged, please contact the local distributor to repair or replace it. • The power cable in the accessory box is for this product only. Do not use it on other products.
	<p>Additional advice:</p> <ul style="list-style-type: none"> • Use the product in an environment with comfortable lighting. It is harmful to your eyes to watch in a too bright or too dark environment. • Relax your eyes watching for a period of time. • Keep sufficient distance from the product to protect your eyes and prevent eyestrain. • Adjust the volume to an appropriate level, especially at night. • Use amplifier equipment as the audio input source with caution. If you must use amplifier equipment, the input power should not exceed the maximum of speaker power. Otherwise, the speaker can become overpowered and damaged.
<p>About USB port.</p> <p>Front USB ports and rear USB 3.0/USB 2.0 ports switch connections based on signal sources. If the current signal source is reading the data from an external product connecting to the port, please switch the signal source after the data reading is complete. Otherwise, the data or product may be damaged.</p>	

1 Overview

1.1 Introduction

Take collaboration to the next level with the Q series interactive display.

Increase productivity and collaboration across the board with a display that uses advanced touch technology.

Each product can be customized to fit your needs. The non-proprietary nature lets you use the software you prefer, take notes on local files, wirelessly cast to the screen from smaller devices, run your favorite apps, and view multimedia files, all while making your experience better than before.

The newline's 4K Ultra High-Definition LED screen also provides a fluid writing experience. Annotate over anything on the screen, whether in the embedded whiteboard or while using any other device. IntelliTouch automatically identifies pen thickness and color, saving you time.

1.2 Parts

- Front View

65" / 75" / 86" / 98"

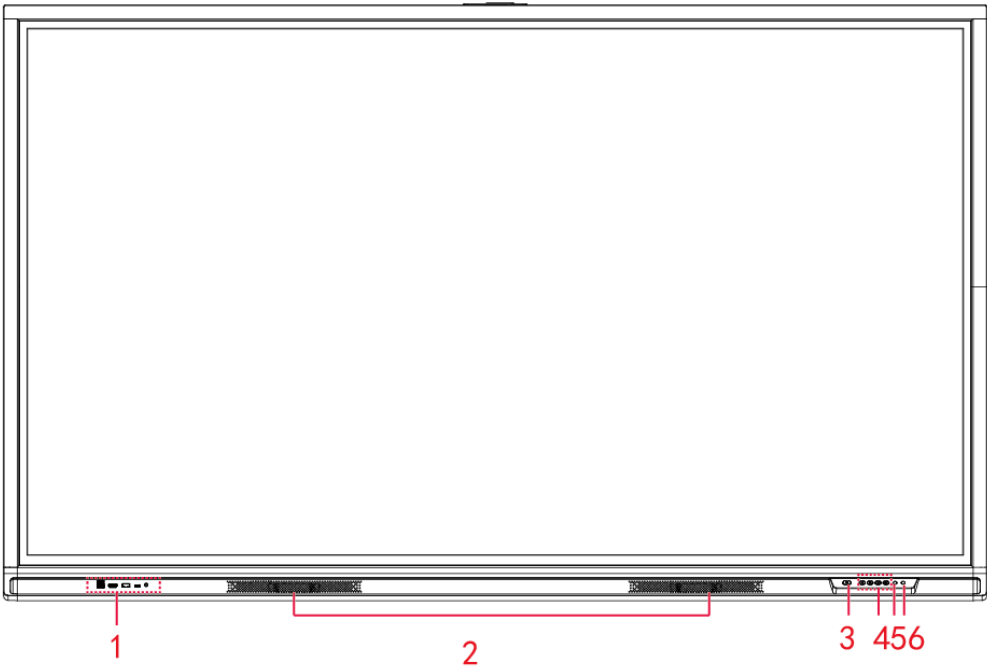

- Rear View

65"

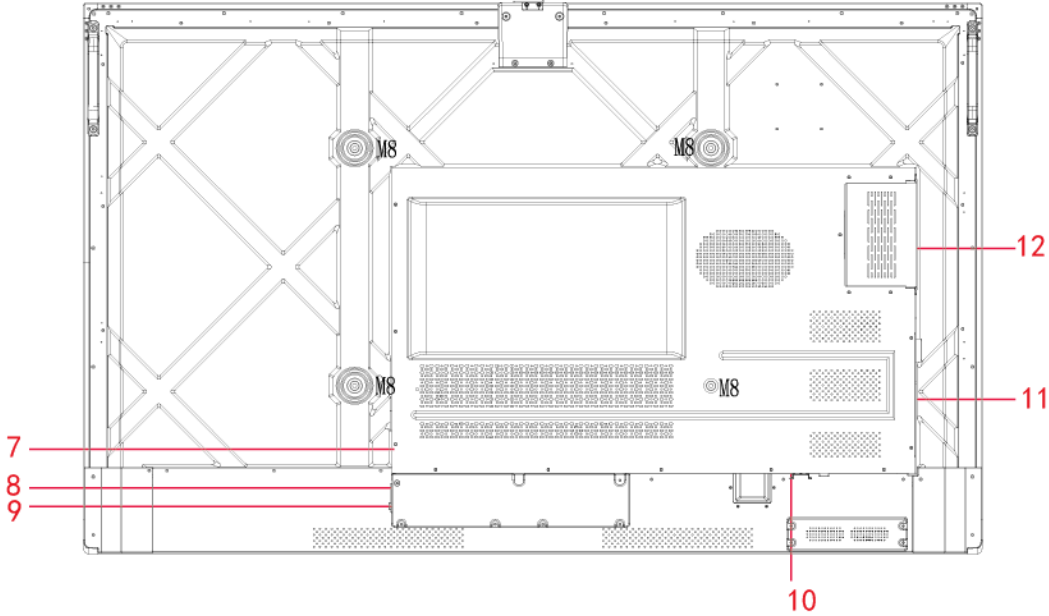

75"

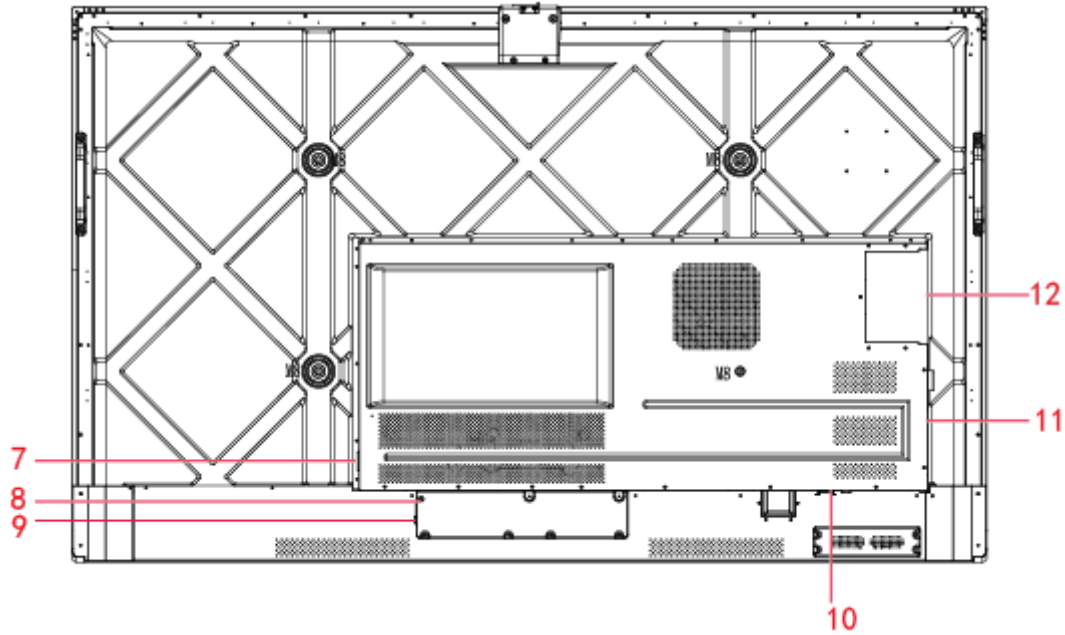

86" /98"

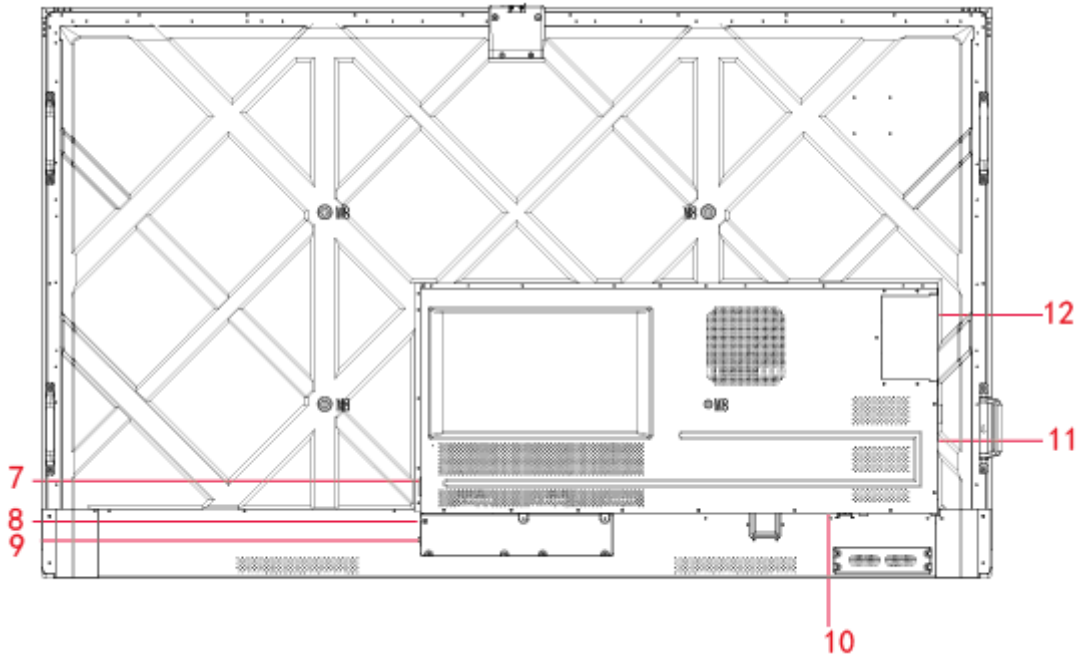

1	Front Ports	7	Power Output Plug
2	Speakers	8	Power Supply Plug
3	Power On/Off	9	Power Switch
4	Front Buttons	10	Rear Ports 1
5	Remote Control Receiver	11	Rear Ports 2
6	Light Sensor	12	OPS Port

1.3 Ports



CAUTION

- *Front USB ports and rear USB 3.0/USB 2.0 ports switch connections based on signal sources. If the current signal source is reading the data from an external product connecting to the port, please switch the signal source after the data reading is complete. Otherwise, the data or product may be damaged.*
- *For USB use, USB 2.0 provides up to 500Ma whereas USB 3.0 provides up to 900Ma of power. Please make sure the USB flash drive is formatted to FAT32 before inserting into the panel.*

- Front Ports

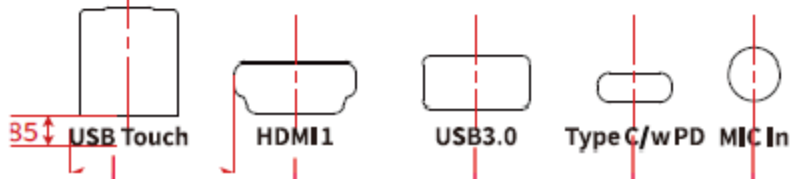
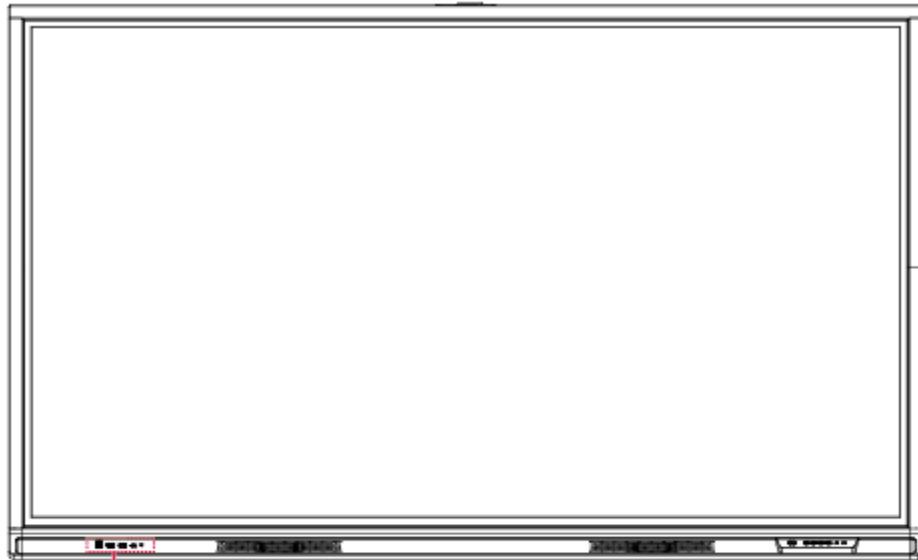

- Rear Ports



WARNING

The rear power output port is supplies 5 V/2 A (maximum) power. Please contact Newline to purchase the power AC adapter for powering external devices. Please do not connect any products which require power than listed. Doing so may cause injury or damage to the panel.

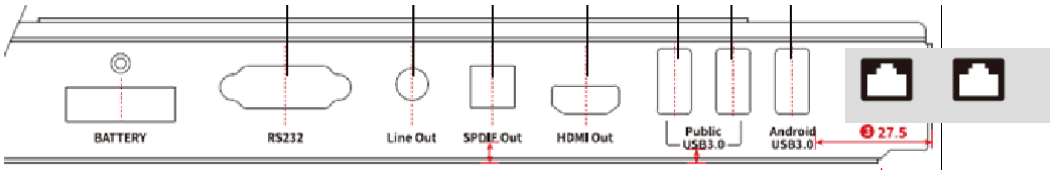



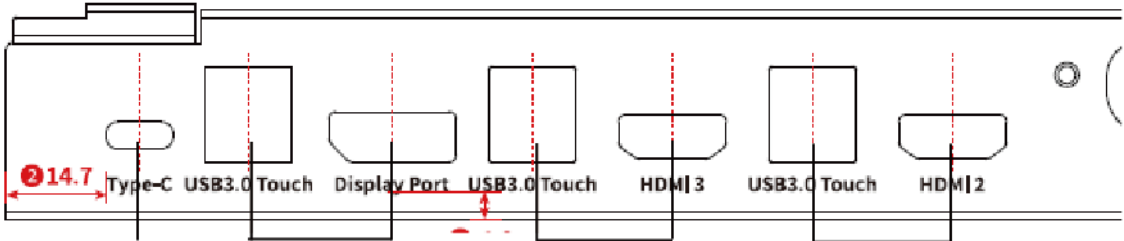
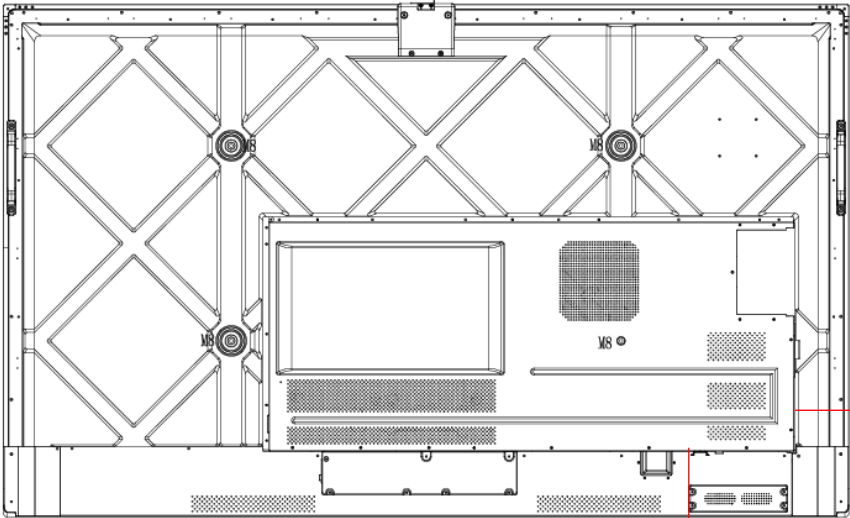

65" / 75" / 86"

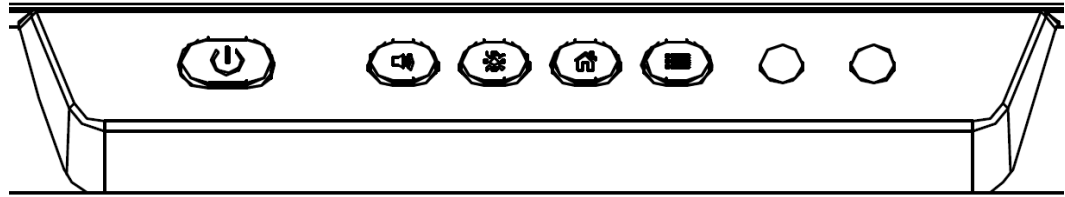

1.4 Front Buttons



















Buttons	Operations	Functions
	Short press	Power on • Solid white color : Display is on and working Sleep mode • The red and white lights flicker alternately: Display enter Sleep mode.
	Long press for more than 2 seconds	Power off • Solid red color : Display is in shut down mode
	Short press	Adjust the Volume
	Short press	Adjust the Brightness
	Short press	Go to the home page
	Short press	Open the Quick Setting menu
	Long press for 5 seconds	Activate/Exit the power button Lock Function

1.5 Remote Control







Carefully read the following instructions before using the remote control to avoid possible faults:

- Do not drop or damage the remote control.
 - Do not spill water or other liquids on the remote control.
 - Do not place the remote control on a wet object.
 - Do not place the remote control directly under sunlight or near a heat source.
-

Buttons	Operations
	Power On/Off
	Mute/Unmute Audio
0-9	Number Keypad
	Go to the Home Page
	Return to Previous/Exit
	Directional Pad
	Confirm/OK
	Start Whiteboard Mode
	Take a Screenshot
	Enable Sound Only Mode
	Press once to freeze the current screen. Press again to exit freeze function
	Adjust the Volume
	Adjust the Brightness
	Enter the Source Selection Page
	App switcher
	Open the File Viewer
	View all Pre-installed Applications
PC	Switch Source to OPS
DP	Switch Source to Display Port
HDMI FRONT	Switch Source to HDMI Front
HDMI 1	Switch Source to HDMI 1
HDMI 2	Switch Source to HDMI 2
VGA	Reserved button
	Reserved button



Buttons	Operations
	Open the Browser Application
	Toggle Display Backlight Mode
	Enter the Screen Lock interface
	<ul style="list-style-type: none">• Open the Quick Setting menu on the embedded os system.• Open the menu in Windows system.
	Open the System Settings

2 Installation Guide

2.1 Safety Precautions

Installation Environment



Installation Direction

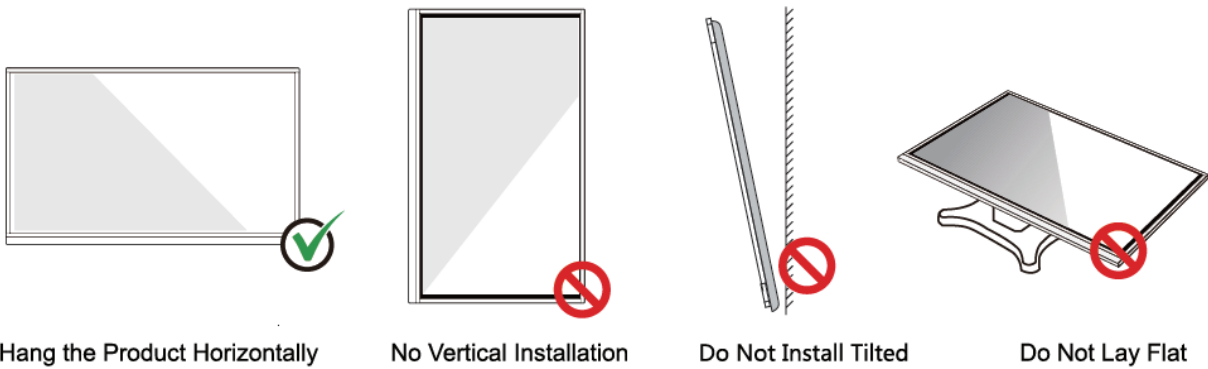

2.2 Installation Precautions

Weight Loading

Weight of the product: 143lb/ 65kg (86INCH), 115lb/52 kg (75INCH), 86lb/ 39kg (65INCH)

- When using a mobile stand, ensure that the weight of the product is less than the loading capacity of the mobile stand.
- When using the wall-mount bracket, ensure that the wall can support the weight of the product. We recommend that the wall surface be reinforced and have a loading capacity 4 times of the weight of the product. Consult a professional installer for wall-mount installation.

NOTE

The company does not undertake relevant legal responsibility for any problems caused by improper operation if the third party mobile stand, or wall-mount bracket is beyond the scope of the product.

- Do not install the product where it might be hit by an opening or closing door.

Vertical installation

When installing the panel, try to keep the panel vertical. An excessive tilt angle may cause damage to the glass or other internal components.

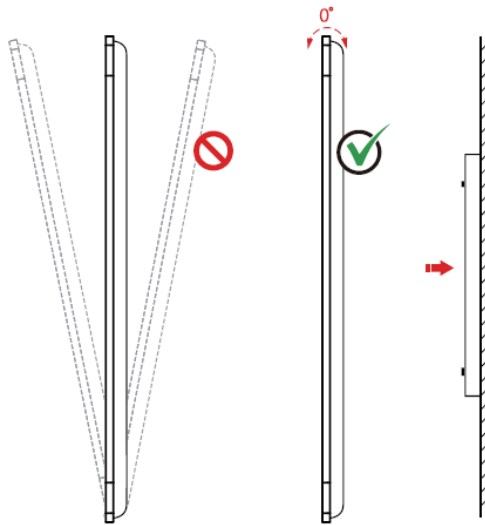

NOTE

For any problem, please contact our support desk. Our company is not responsible for any damage or losses incurred by users if the users fails to follow the instructions.

Ventilation

Ensure adequate ventilation and/or an air conditioned environment. We recommend keeping certain distances from the side of the product to the wall or panels. Ventilation requirements are shown in following figure:

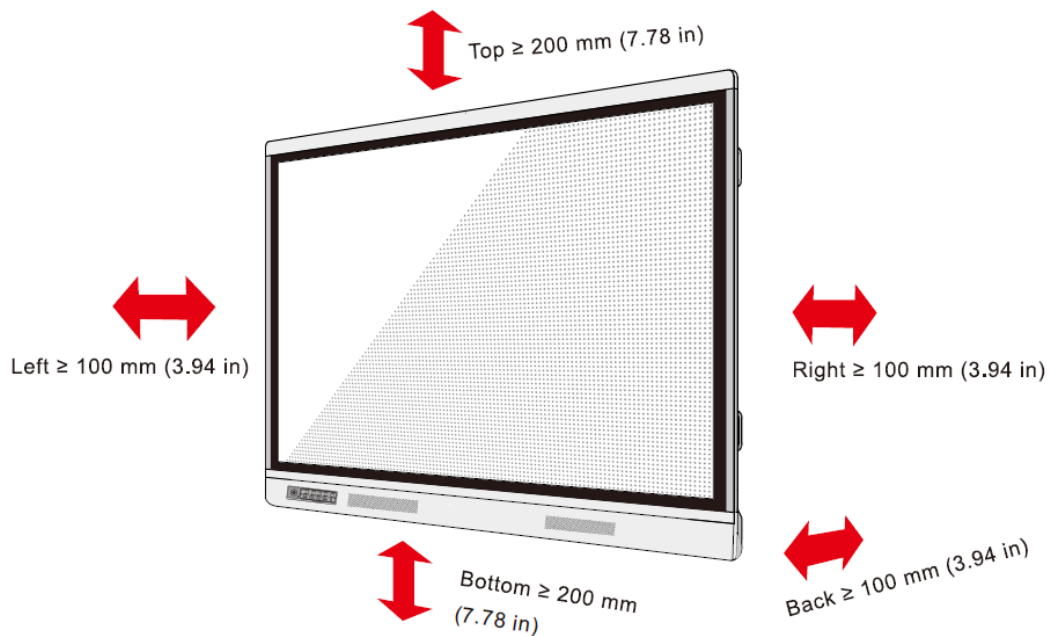

(Tips: Updated to Q Series front panel figure)

2.3 Installation

The dimensions of the four bracket mounting holes on the back panel are VESA MIS-F compliant (86 inch or 75 inch: 800 x 400 mm/31.50 x 15.75 in; 65 inch: 600 x 400 mm/23.62 x 15.75 in). Use metric M8 screws with a length of 10 mm to 15 mm (0.40 to 0.59 in) to secure the touchscreen to the mounting system. Dimensions of the mounting holes on the back panel are shown on the following figure:

 **NOTE**

Consult a professional installer to install the display product.

75"/86"/98":

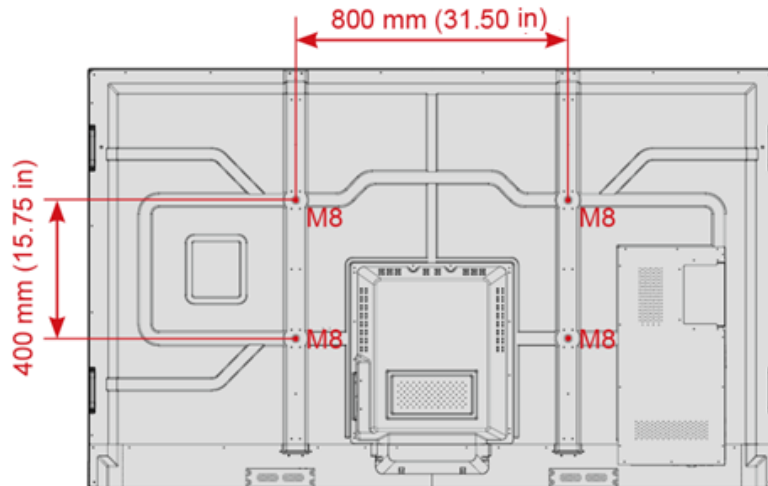

(Tips: Updated to Q Series Back panel figure)

65 inch:

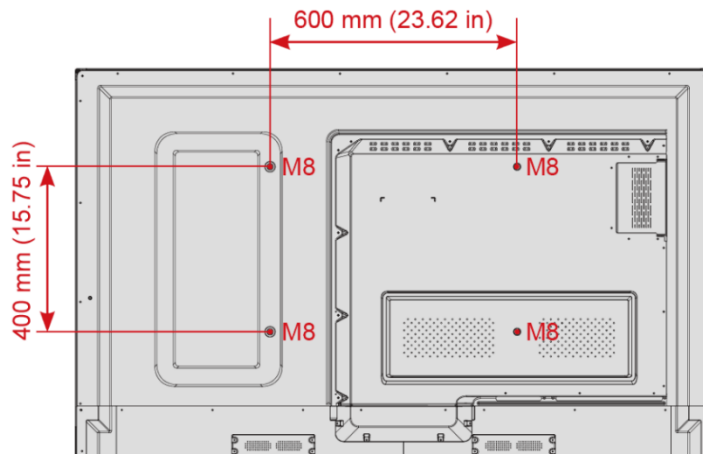

(Tips: Updated to Q Series Back panel figure)

2.4 Installing the OPS (Optional)



The OPS does not support hot plugging. Therefore, you must insert or remove the OPS when the display is powered off. Otherwise, the display or OPS may be damaged.

You will need to purchase the OPS separately. Perform the following steps to install the OPS:

Step 1 Unscrew the M3 screws by hand to remove the OPS protective cover.

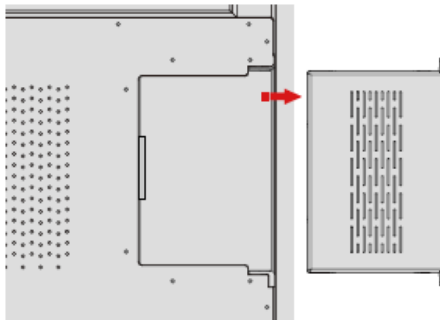

Step 2 Slide the OPS into the OPS port on the rear of the panel until firmly seated.

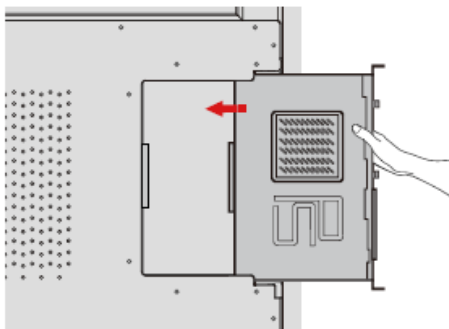

Step 3 Secure the OPS to the display by using the M3 screws.

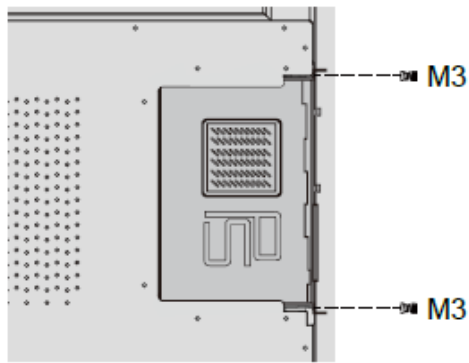

Step 4 Ensure the installation is correct before powering on the panel.

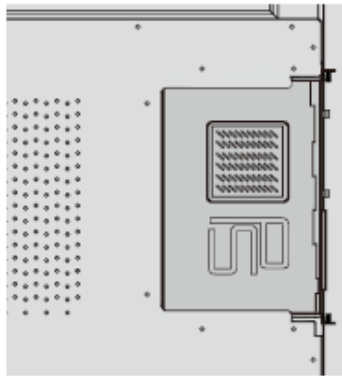

2.5 Installing Newline Assistant

2.5.1 Introduction

The Newline Assistant agent is a tool used as a bridge between the embedded operating system and the OPS. It helps add Windows software shortcut to the Home Page, as well as to protect USB data when switching between sources.

Therefore we strongly recommend users install the Newline Assistant after installing the OPS.

2.5.2 Installation

- Step 1** Install select the OPS correctly (See "**¡Error! No se encuentra el origen de la referencia.**").
- Step 2** On the **Home Page**, tap **OPS** and the source will switch to the Windows operating system.
- Step 3** Visit our website at www.newline-interactive.com and choose **Products > Q series > download** to download the Newline Assistant installation package.
- Step 4** Install the [Newline Assistant](#) as instructed.

3 Getting Started

3.1 Power On

Step 1 Ensure the power cable is fully seated into the panel and wall outlet before powering on the panel. Please confirm your wall outlet supports a power range of 100V to 240V with frequency at 50 Hz/60 Hz \pm 5% and is fully grounded.



NOTE

The power outlet should be installed near the equipment and should be easily accessible.

Step 2 Flip the power switch located on the side of the product to “I”.

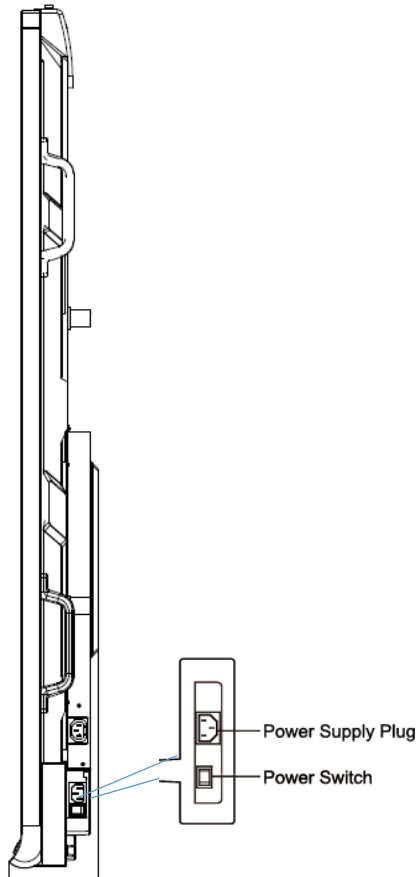

65" / 75" / 86" / 98":





(tips: Image to be updated)

Step 3 Press the power button  on the front control panel or  on the remote control.

3.2 Power Off

Step 1 Press the power button  on the front panel or the power button  on the remote control to enter sleep mode.

Step 2 Long press the power button  on the front panel or the power button  on the remote control, The **Warning** dialog box will be displayed as shown in the following figure.

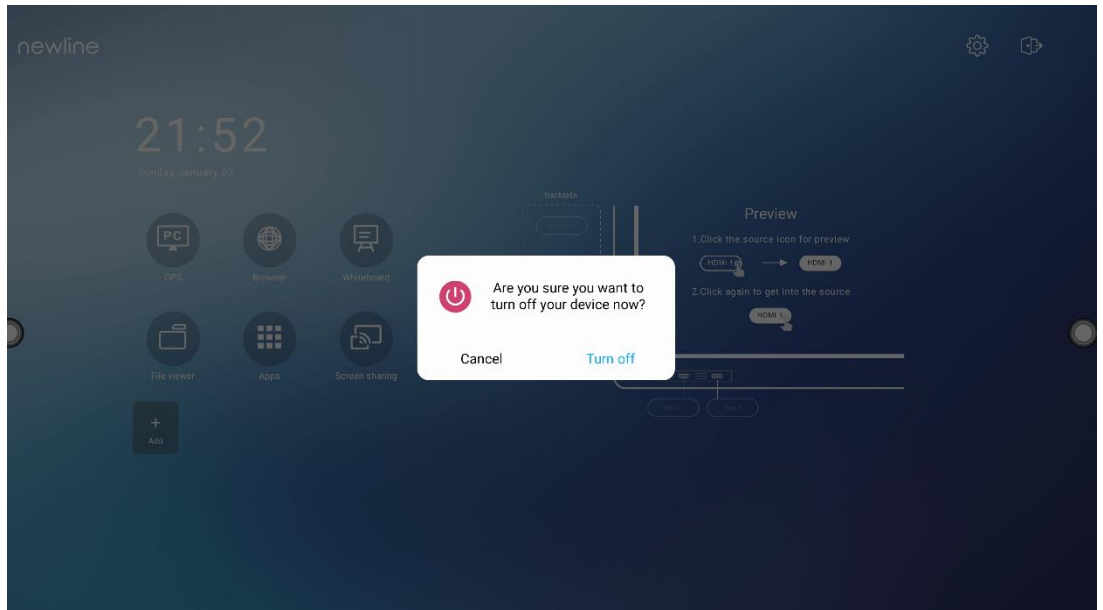

Step 3 In the **Warning** dialog box, tap **Cancel** to return to working mode. Tap **Turn off** to turn off the panel, and the power indicator will turn to red.

Step 4 If you want to completely turn off the product, turn off the rocker switch behind the panel (next to the power socket) and unplug the power cord.

 **NOTE**

- If an OPS is installed, the OPS and the screen will simultaneously powered off when the power is shutoff.
- Please properly shut down the panel before disconnecting the power source or it may cause damage. Accidental power failure may cause damage to the panel.
- Do not repeatedly turn the power on & off in a short period of time as it may cause malfunction.

3.3 Calibration

If the cursor position has a big deviation from the actual touch point, calibration is used to eliminate the deviation. Calibration is required in the following scenarios:

- The OPS is used.
- A computer is connected through the HDMI or Display Port interface.

 **NOTE**

Interface operation on the embedded operating system does not need positioning. External products with Microsoft Windows 7 or later versions will require positioning.

If the positioning is not correct, perform the following operations to calibrate again. The following takes Windows 10 as an example:

Step 1 Ensure that the HDMI or DP interface and external products are connected properly.

Step 2 Select the corresponding Windows signal from the signal source menu. The Windows page will be displayed.

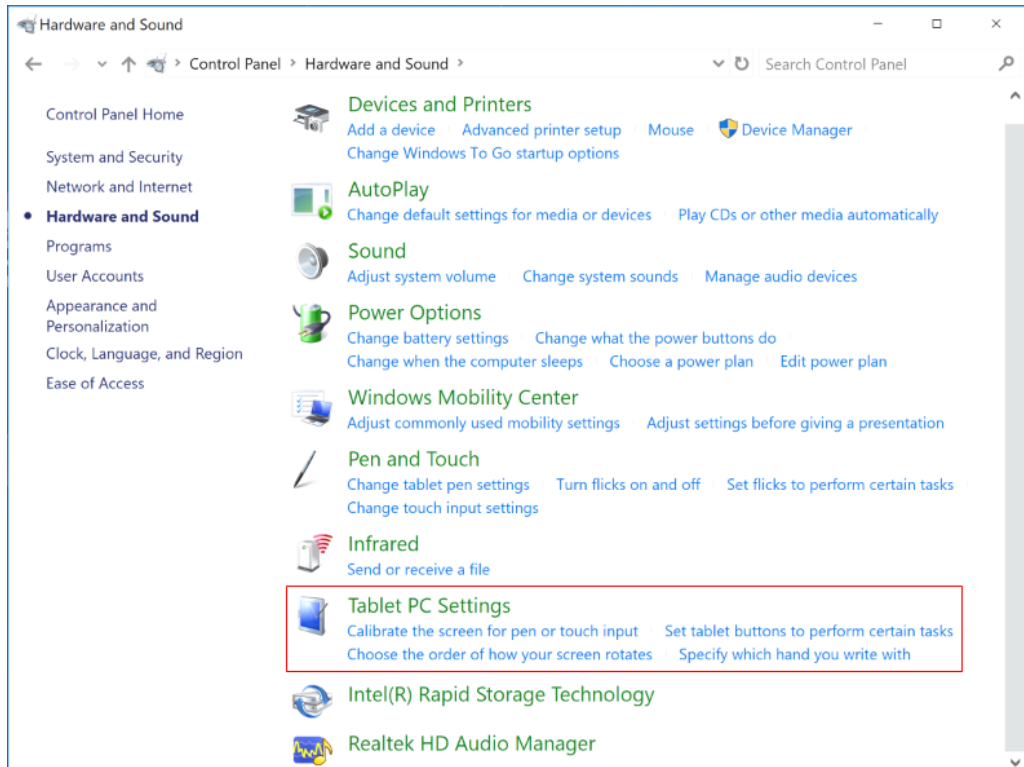

Step 3 Select **Tablet PC Settings** on the **Control Panel** page.

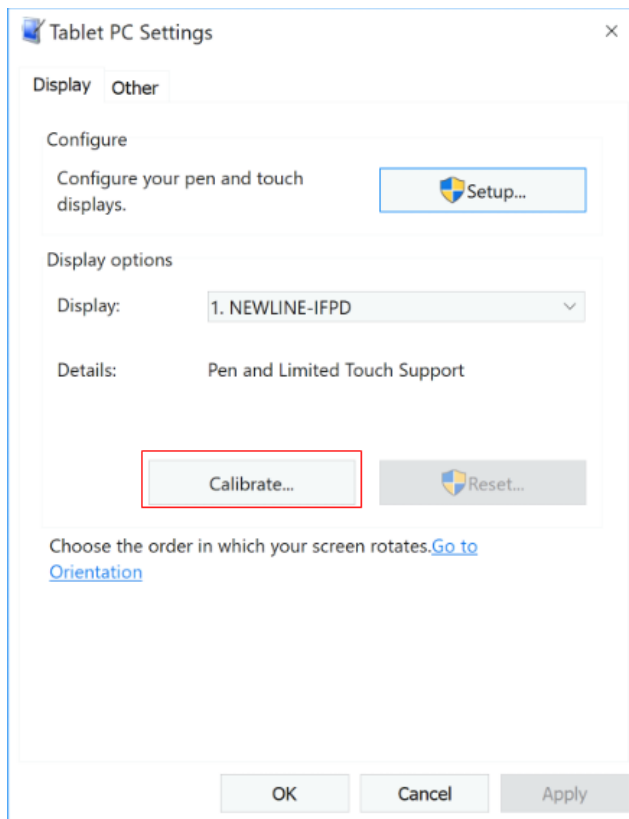

Step 4 Select  in the Tablet PC Settings window.



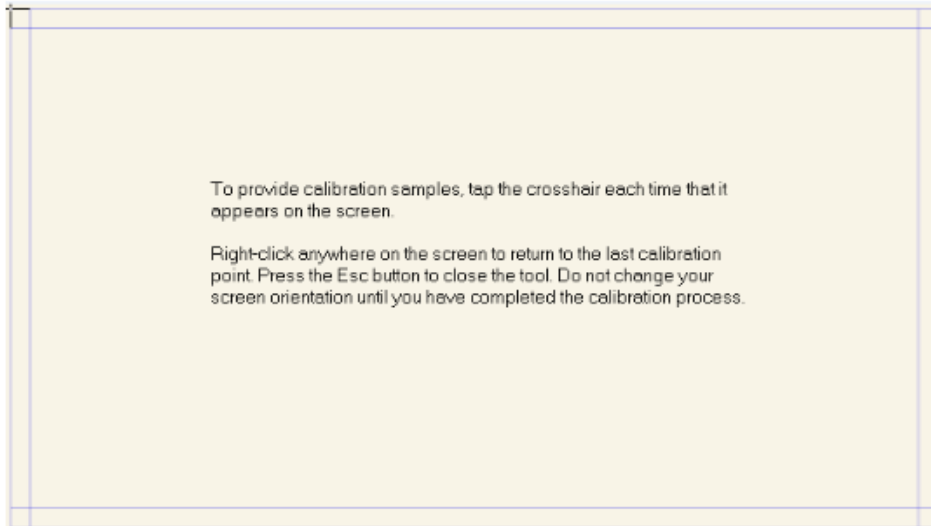

Step 5 Select **Touch input** from the option and start calibration.

Step 6 Use your finger or a pencil to click and hold the center of the flickering crosshair . Do not release until  moves to the next positioning point. Complete the calibration process as instructed.

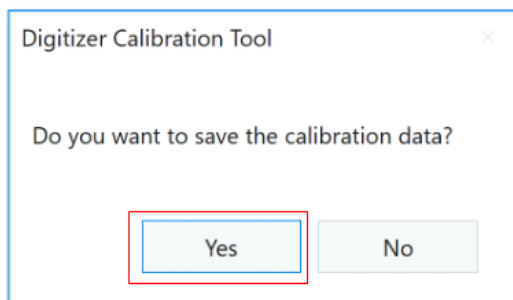

Step 7 After the calibration is complete, the **Digitizer Calibration Tool** dialog box will be displayed. Click **Yes** to save calibration data.



 **TIP**

- To ensure writing accuracy, use the pencil or stylus included with the product for proper positioning.
- Positioning errors may cause failure of touch functions of the display. In that case, please perform calibration again.

Step 8 The **Tablet PC Settings** dialog box will be displayed again. Tap **OK**. The calibration will be complete.

4 Operating the Touch Screen

4.1 Profile Logon

When the panel is powered on, the panel will show all the registered accounts as shown in the following figure:

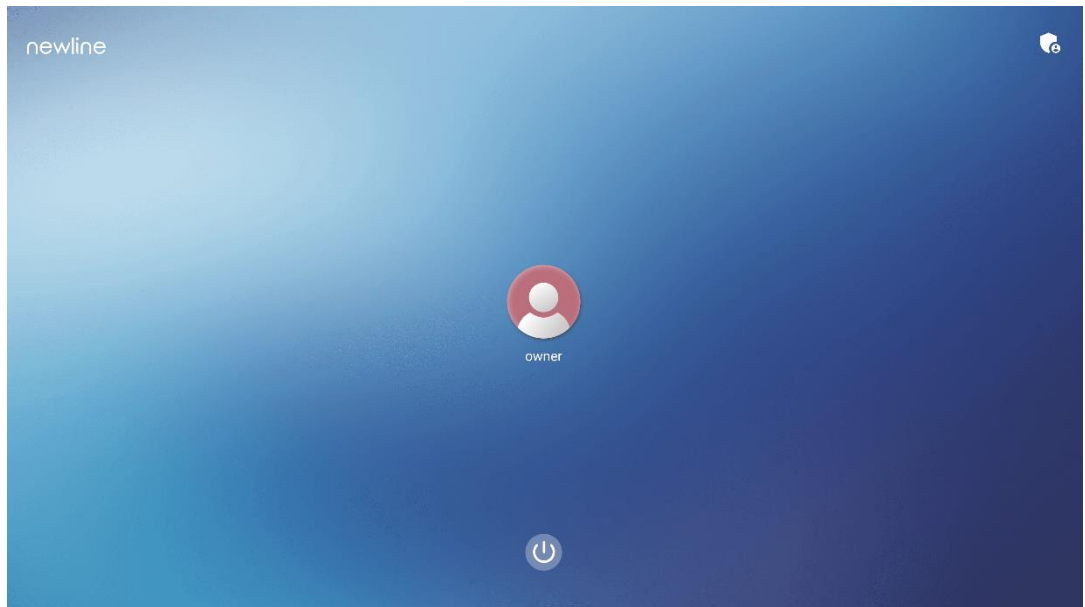

Tap the  icon to enter the 6 digits passkey and log into the system homepage. Default passkey is 2364606633.

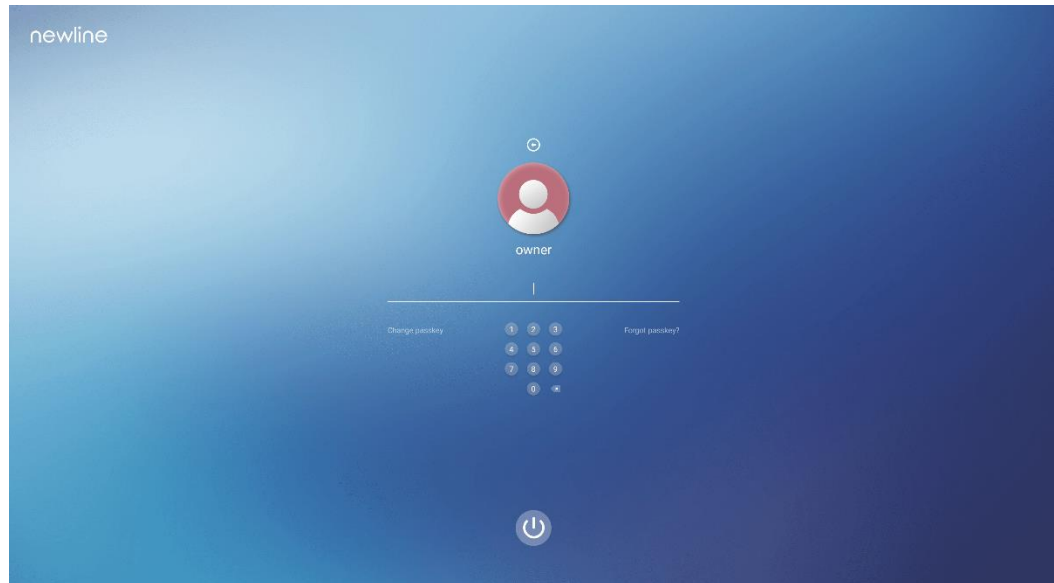

Notes:

The passkey is only limited to 6 digits, English letters are not allowed. After passkey enabled, every time you boot up the screen, system will request the passkey.

If you forgot your passkey, please contact your administrator to reset your passkey.

4.2 Home

Once logged into the system, the user will be taken to the **Home** page as shown in the following figure:

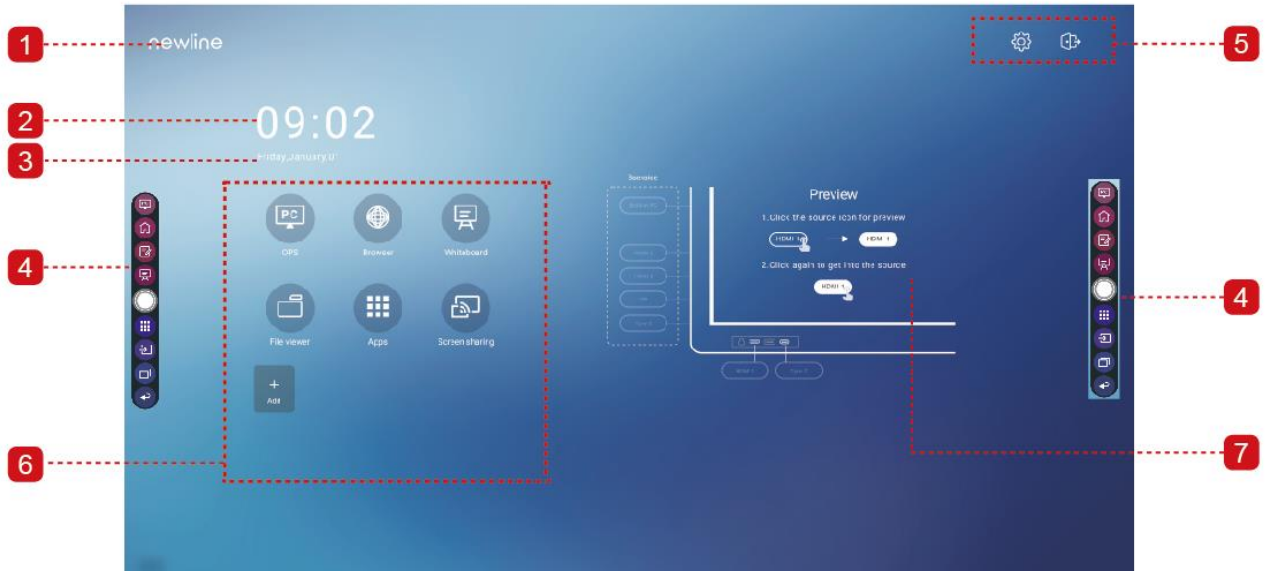

- 1: Logo (Shortcut to Settings) 2: Clock (Shortcut to Clock)
3: Date and Week(Shortcut to Calendar) 4: Side Toolbar 5: Status Bar and Settings
6: Main Icon 7: Preview Window for Signal Source

Shortcut for Logo & Wallpaper Settings

Tap the **newline** icon on the **Home** Page to enter the **Display & Theme** page, you can tap **Set logo** to set the logo image, as shown in the following figure:

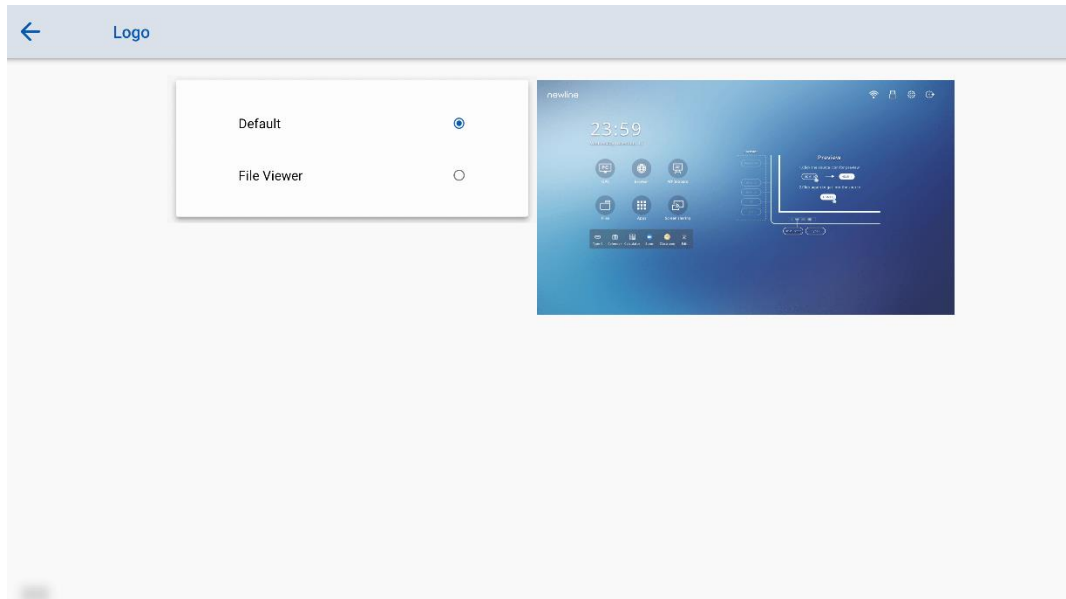





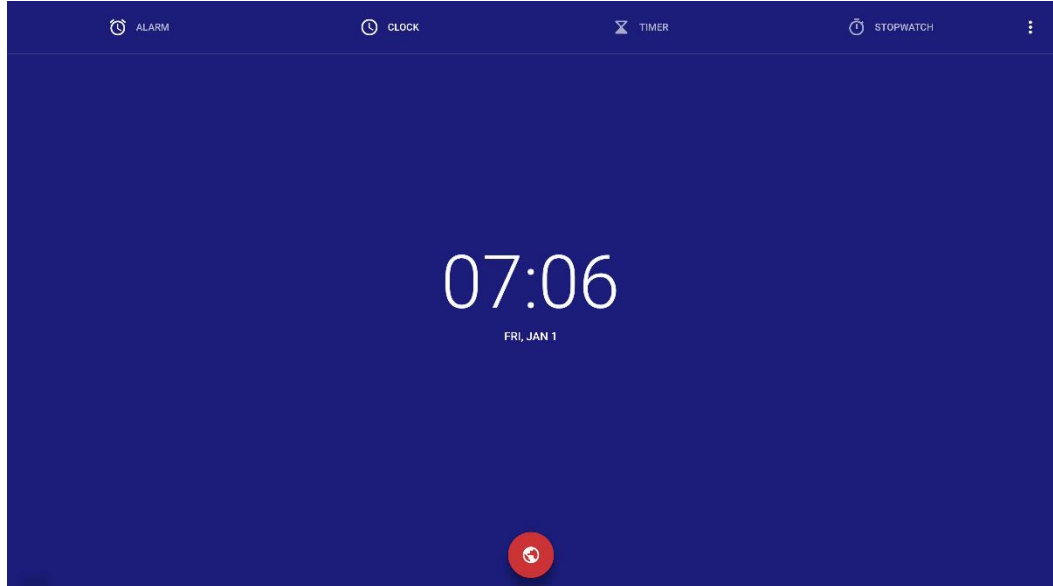

Shortcut for Clock

Tap the time icon on the **Home** page to start the clock application. Using the icons on the top, you may switch from clock mode to alarm mode, or to timer and stopwatch mode. In the clock mode, you may tap  to add other time zones as shown in the following figure:



Main Icon

Icon	Functions
	Tap to switch to the OPS source.
	Tap to open the browser.
	Tap to open the whiteboard function.
	Tap to open the File viewer application to explore internal and external files on the panel.
	Tap to enter the app interface. Apps displays all pre-installed applications, including Calculator, Calendar, Clock, Settings, Newline Cast, File Viewer, Office Suite , and...etc. Tap the icon of an application to run the application.
	Tap " Screen Sharing " icon to enable the wireless screen sharing function. Note: By default, the " Screen sharing " icon is displayed after startup.
	Tap Add icon to customize the main icon. You can add up to 5 shortcuts to your Apps. (See more detail in "Add Shortcuts to Home Page")

- **Side Toolbar**

By default, the toolbars display the OPS source, Home, Annotation Mode, Whiteboard, Apps, Sources, App Switcher and Return icons on both sides of the screen. You can hide one or both toolbars in the Settings, slide them up and down, minimize or maximize them by simply

tapping the "" icon.

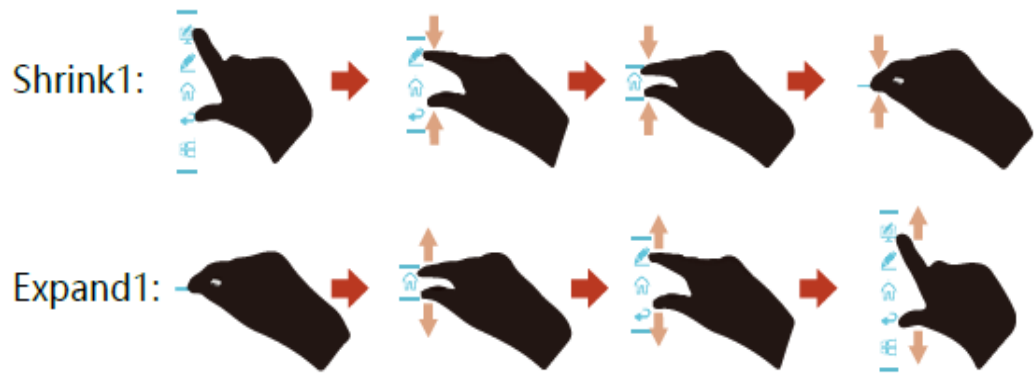











(Tips: Image to be updated)



(Tips: Image to be updated)





The functions of the side toolbar are as follows:

Icon	Functions
	Switch to the OPS source.
	Go to Home page.
	Tap once to start annotation mode, tap again to stop annotation and take a screenshot.

Icon	Functions
	Switch to whiteboard mode.
	Minimize or maximize the toolbar.
	Go to Apps folder.
	Tap to view the external internal sources, including HDMI 1, HDMI 2, HDMI 3, Front Type C, Type C and Display Port.
	App switcher allows the user to manage currently running applications. Swipe up or down to view currently running applications, swipe left or right to close the application or tap “  ” icon to close all the applications.
	Return to the previous menu or exit an app.

Status Bar and Settings

The upper right corner of the home page displays three working status icons (including USB drive(s), Ethernet, and Wi-Fi), system setting shortcut and log out icon.



Icon	Functions
	If a USB drive is connected to the USB port, this icon will appear highlighted.
	If the product is connected to Ethernet, the icon will appear.
	If the product is connected to a wireless network, the icon will appear.
	Tap to enter the system setting page.
	Account log out and return to the lock screen.

4.3 Sources

On the **side toolbar** page, tap  to enter the signal source selection, including Front Type C, Type C, HDMI 1, HDMI 2, HDMI 3 and Display port.

The icon without signal source connected is gray, and the icon with signal source connected is white. After you choose white icon, the content of the signal source can be displayed in the preview window for real-time preview.

You can enter sources interface by the following methods:

- Tap the  icon on the side toolbar;
- Tap the  icon on the quick settings;
- Tap the  icon on the remote control.

4.4 Preview window

On the **Home** page, signal source preview window including build-in PC, Front Type C, Type C, HDMI 1, HDMI 2, HDMI 3 and Display port.

An icon without an active signal source connected will be gray, an icon with an active signal source connected will be white, and the icon of the signal source currently being previewed will be blue. After you choose a white icon, the content of the signal source can be displayed in the window for a real-time preview, the icon color will change from white to blue, and the name of the preview window for the signal source will change to match with the signal source being previewed.



4.5 OPS

On the Home Page, tap **OPS** to enter the OPS source, as shown in the following figure. If the display is not equipped with an OPS, "No Signal" is displayed.



4.6 Screen Sharing

Multiple devices can be cast wirelessly to the display through several casting modes (Airplay, Google Cast...). To cast: tap Screen Sharing on the Home Page to enter Newline Cast. On screen directions will appear for you to follow in order to wirelessly cast to the display, as shown in the following figure:

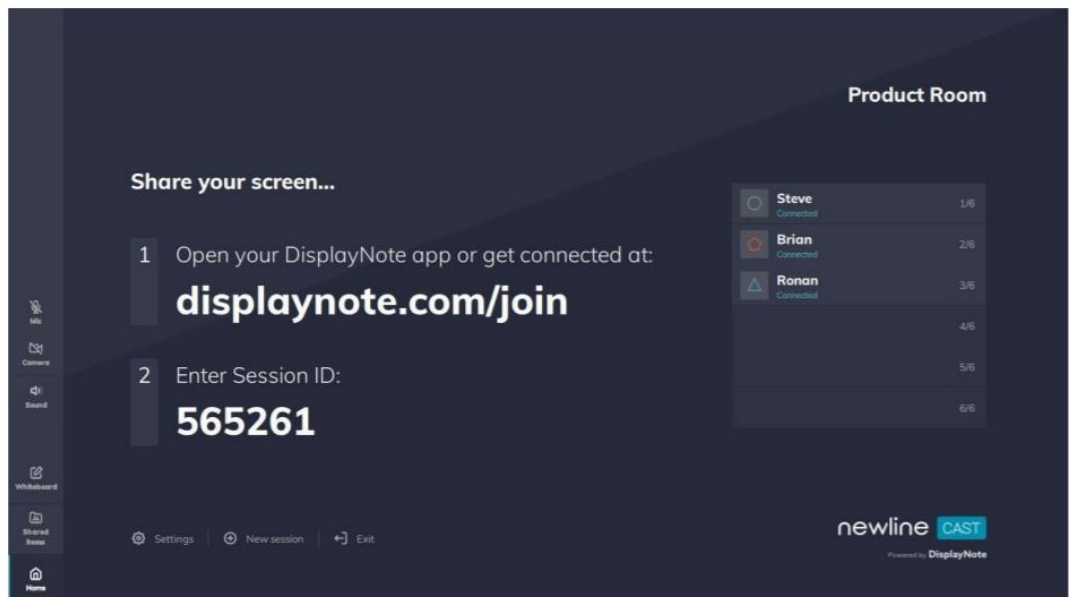

4.7 Whiteboard

The whiteboard function is designed to present conference writing to attendees in a quick and easy manner. The whiteboard has the following functions:

- **Discussion and screen annotation**
On the whiteboard page, you can select pen type, width, and color to write or annotate on the screen. You can also erase selected content or clear all content on the screen.
- **Page navigation**
Preview or delete pages.
- **Palm rejection**
When Palm rejection is turned on, fingers and pen can write and draw, but palm and fist would not be recognized.
- **Palm eraser**
When Palm eraser is turned on, fingers and pens can also be recognized, and palm and fist will be recognized as large eraser.



Note:

The Palm reject and Palm eraser function are available for whiteboard and annotation application, both of which are mutually exclusive and cannot be turned off simultaneously. You can turn on/off Palm reject and Palm eraser function on the quick setting menu.

Whiteboard Mode

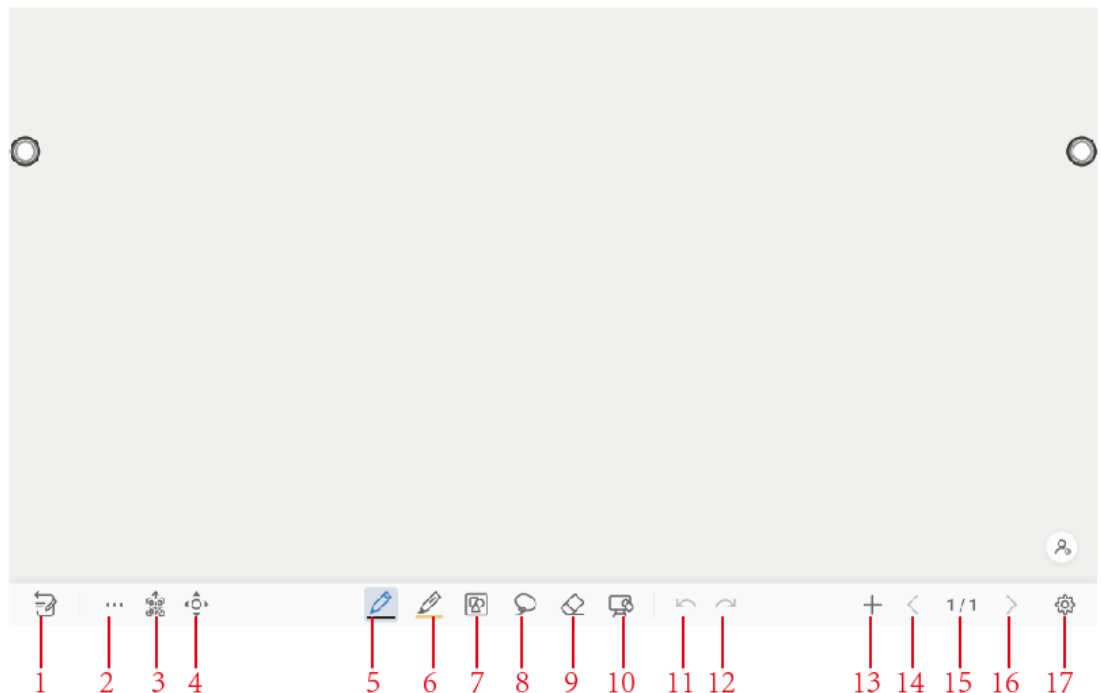
- Tap **whiteboard** icon on the Home page or tap  on either side toolbar to enter the embedded whiteboard mode, as shown in the following figure:



- Tap  on the side toolbar or tap  in discussion mode to enter annotation mode. In annotation mode, a transparent layer lays over the screen, letting you write over whatever is on the screen until you exit annotation mode.

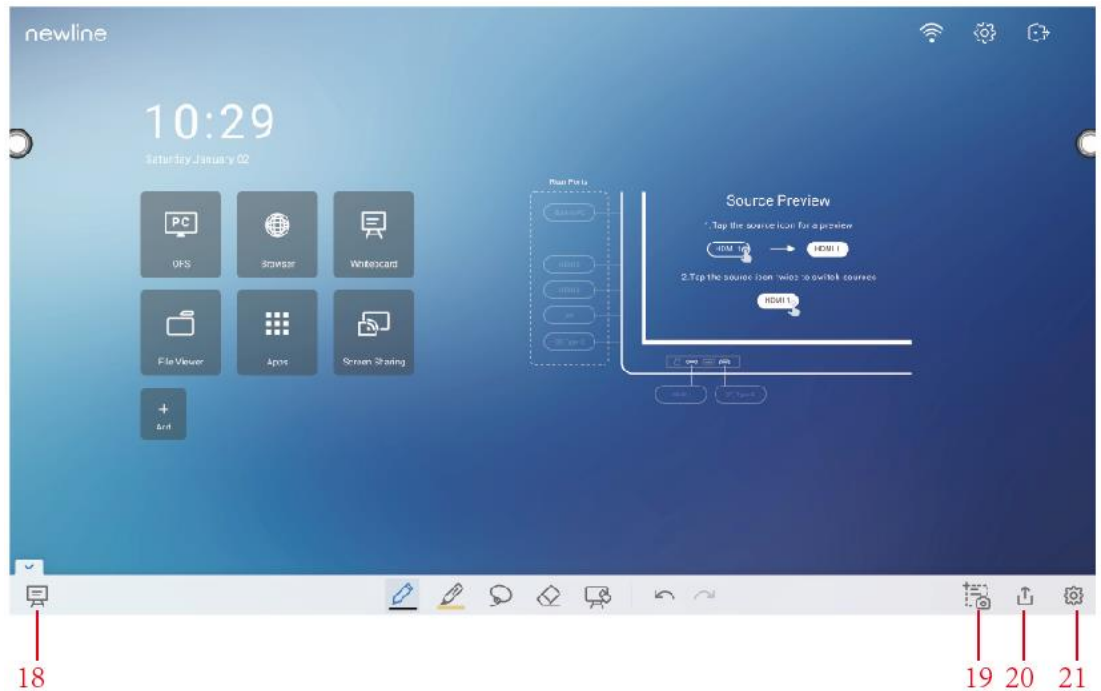



SN	Icon Name	Icon Function
1	Mode Switch	Tap to switch to annotation mode.
2	More	Tap to enter options interface. Users can insert image, Text, Sticky note, Search Image or Search Web etc.
3	QR Code	Tap to export the whiteboard data into QR Code.
4	Move Canvas	Tap to enter move canvas function, press and move your finger in the page to move canvas and content on it
5	Pen	Tap to use the pen function, and the icon turns into blue. Tap and hold the icon for two seconds to set the size and color.
6	Highlighter	Tap to use the highlighter function, and the icon will turn blue. Tap and hold the icon for two seconds to set the highlighter size or color.
7	Insert Auto shape	Tap to enter the auto shape selection interface. Users can insert the shapes and set the shapes color.
8	Select	Tap to select and edit the whiteboard content. When the object is selected, users can move, zoom in/out, copy, cut, rotate, lock, change layer or delete object.
9	Eraser	Tap to select the eraser function and the icon will turn blue. Tap and

- Page settings

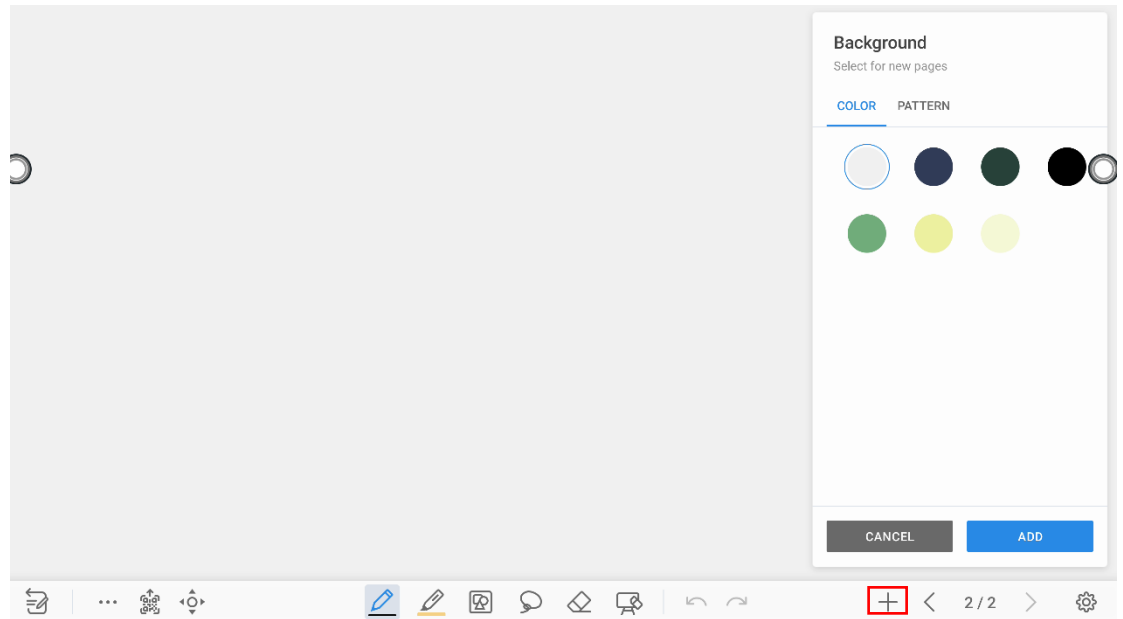
Tap and hold **+** for two seconds to set the color and the pattern of the new page, as shown in the figure below.



Mode Switch

Tap  and  in the lower left corner of the discussion mode to switch between whiteboard modes.

- Annotation mode

The background is transparent and the real-time image of the current signal source will be displayed. You can comment on presentation content such as Office documents and pictures as shown in the following figure:

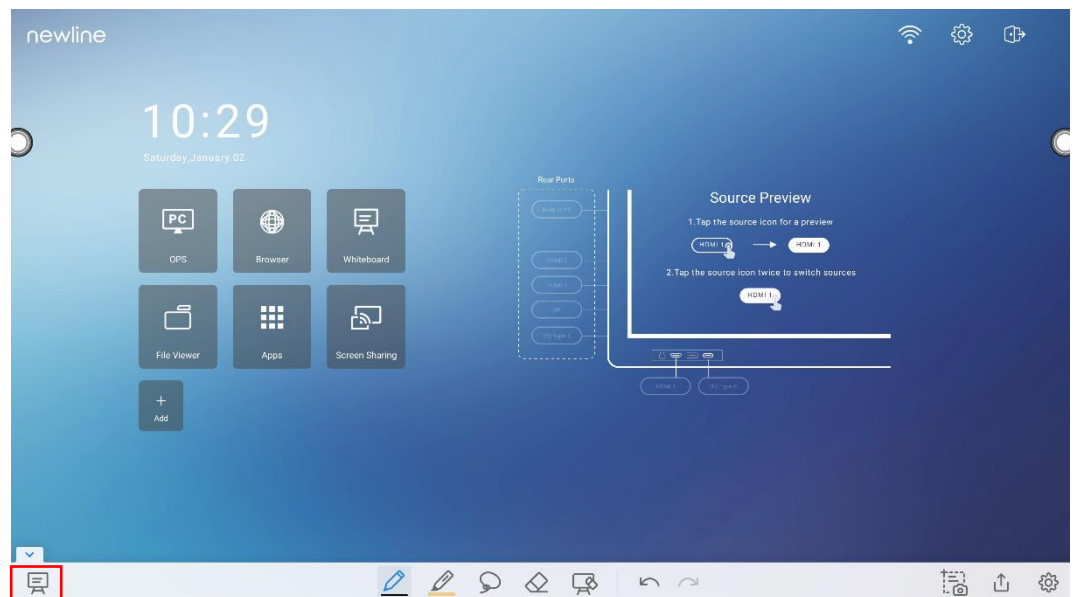

- Discussion mode

The background is a single color, as shown in the following figure. You can write content on the page as you wanted.

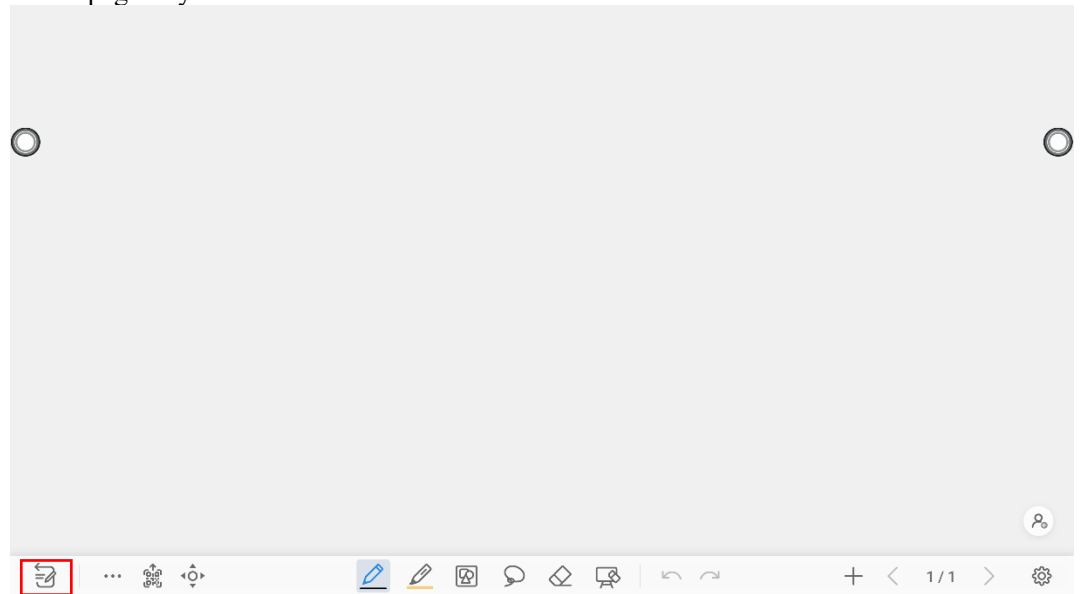

Options

Tap the  icon to enter options interface. Users can manage files, add Text, Sticky note, Search Image or Search Web etc.

On the **FILE** items, you can import data from file management, save whiteboard files and export whiteboard page.

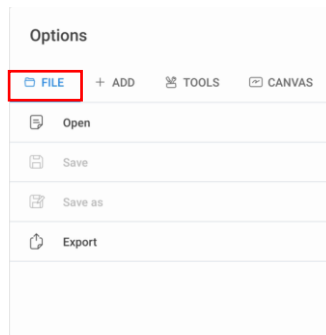

On the **ADD** items, you can import the pictures, Text, Sticky note, PDF document from system files, USB, network. You also can import the Search Image or Search Web in the internet.

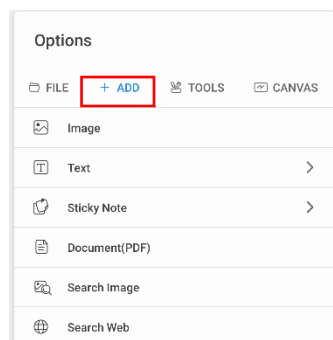

On the **TOOLS** items, you can use rulers to draw line or shape on the page, import the visualizer image etc.

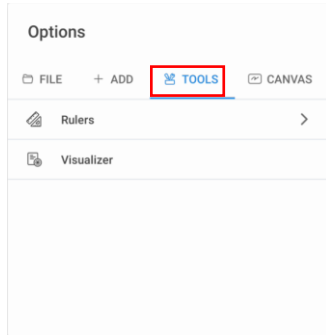

On the **CANVAS** items, you can choose split mode to set the split application.

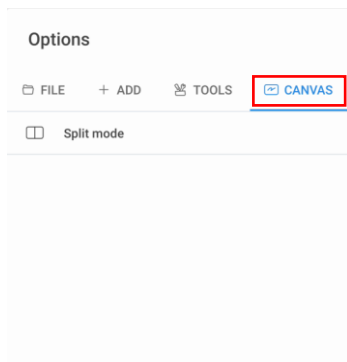

QR code export

On the Whiteboard, tap  to pop up QR code exporting windows. You can export the whiteboard page into QR Code, before that, you can customize the number of export page, change the export format at first.

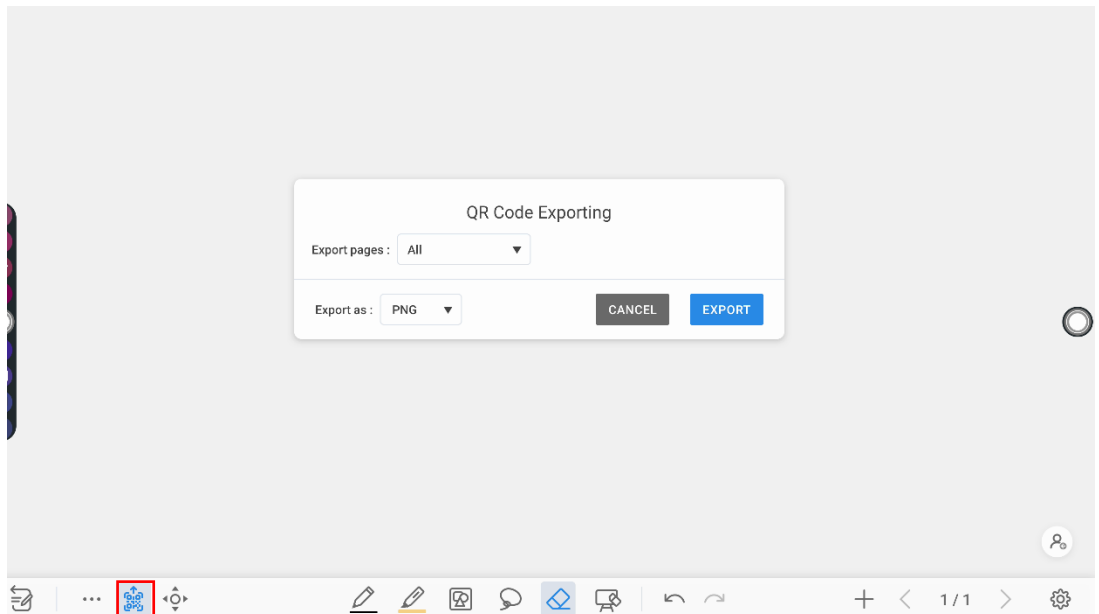

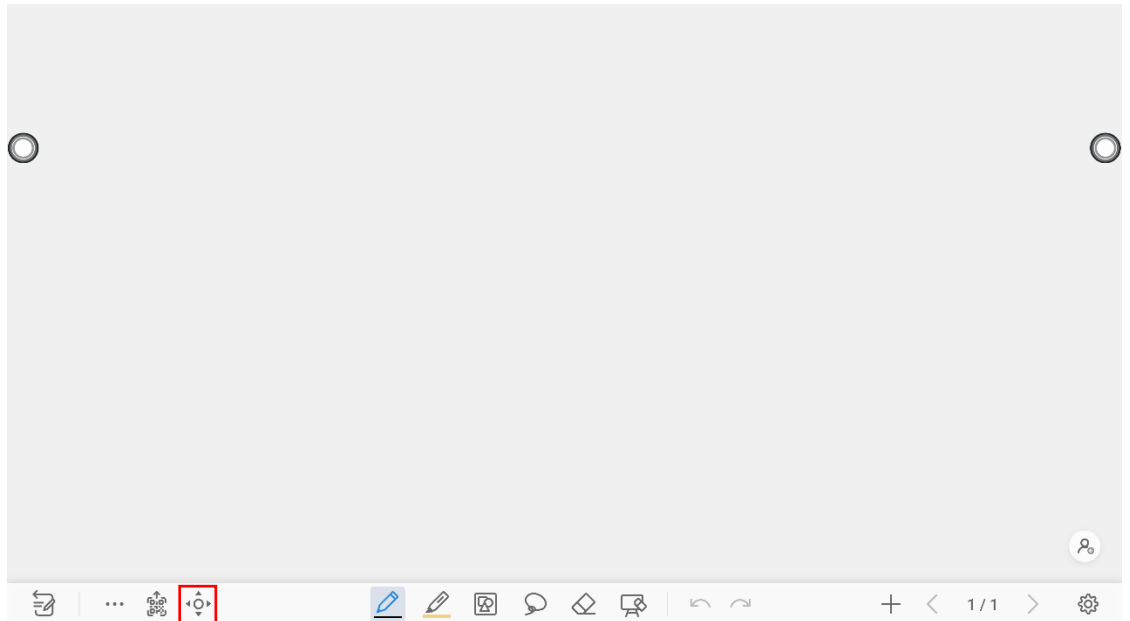

Move canvas

On the whiteboard, tap the icon to enter move canvas function, press and move your finger in the page to move canvas and content on it.





Pen Type

On the Whiteboard, two types of pens are supported: Pen and highlighter.

- Pen  : used to write.
- Highlighter  : used to highlight. Characters covered by comments are still visible.

Line Size and Color

On the Whiteboard, tap and hold  or  for two seconds to set the size and color. You can select the line size and color for writing, as shown in the following figure:

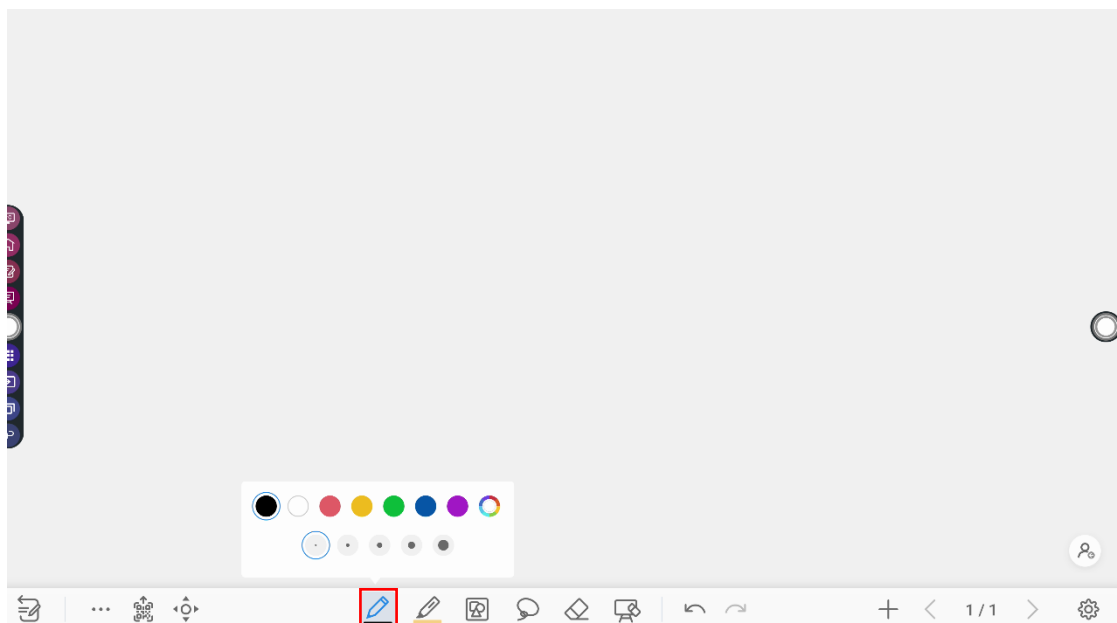

Insert auto shape

On the Whiteboard, tap  to insert the shape or set the shapes and color.

Shapes: Circular, ellipse, square, equilateral triangle, right triangle, star, arrow, line

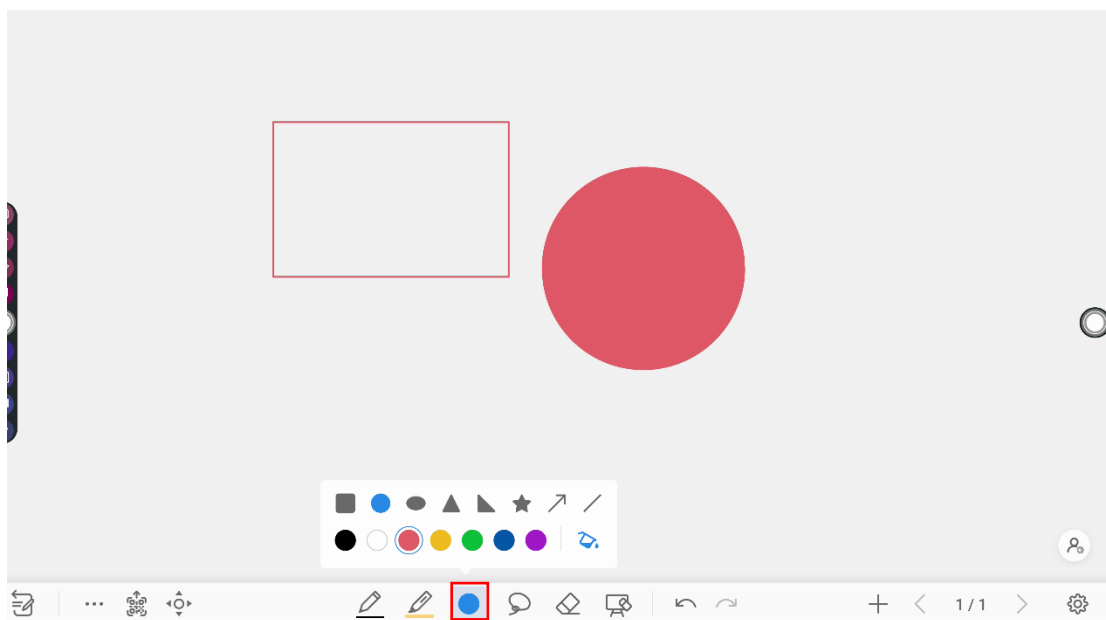

The  icon supports three status:

Unavailable: The icon is unavailable when users insert arrow and line;

Unselected: The edge of shapes are colored when the icon is not selected;

Selected: the shape will be filled with colors when you import the shape;

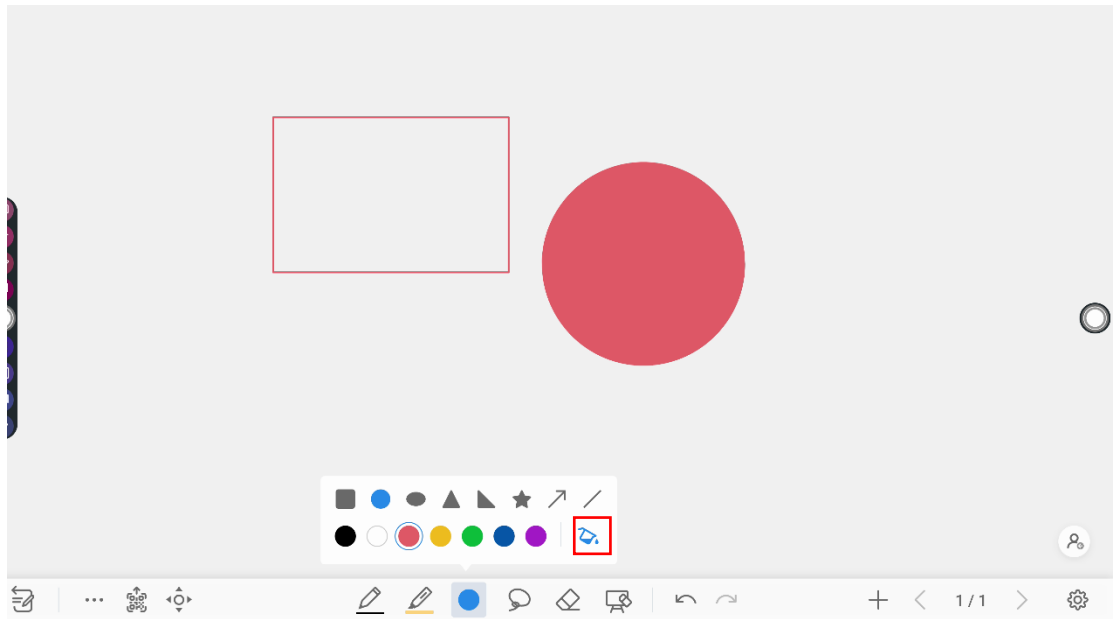

Select

On the Whiteboard, tap  and user could choose the data on the page to move/ zoom in/ zoom out/ rotate/change colors.

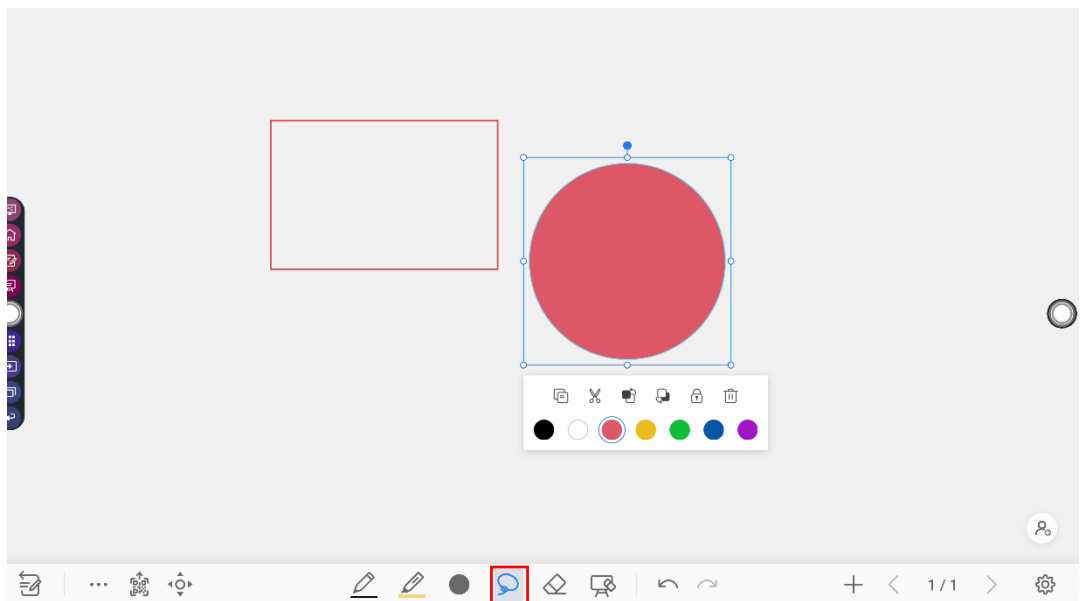





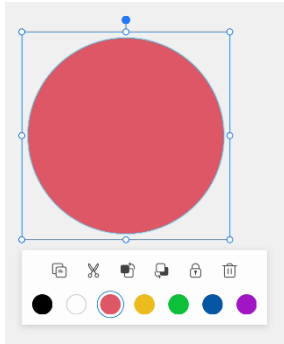

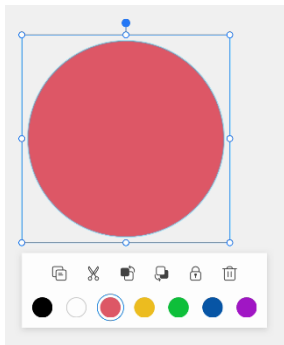

Finger gesture

Rotate:



Zoom in/out:





Icon	Functions
	Long press this icon to Rotate the selected items
	Tap this icon to copy the items.
	Tap this icon to cut the items.
	Tap this icon to Push to top layer.
	Tap this icon to Push to bottom layer.
	Tap this icon to lock the layer.
	Tap this icon to delete the items.
	Paste (long press the screen around two seconds, the icon will appear only after one item copied or cut)

	Tap this icon to unlock the layer. (the icon will appear only after one item locked)
---	--

Eraser

Two methods are available to erase written errors or content as follows:

- Partial eraser: Tap  to clear the passing part of eraser.
- Object eraser: Tap  to clear the whole object.

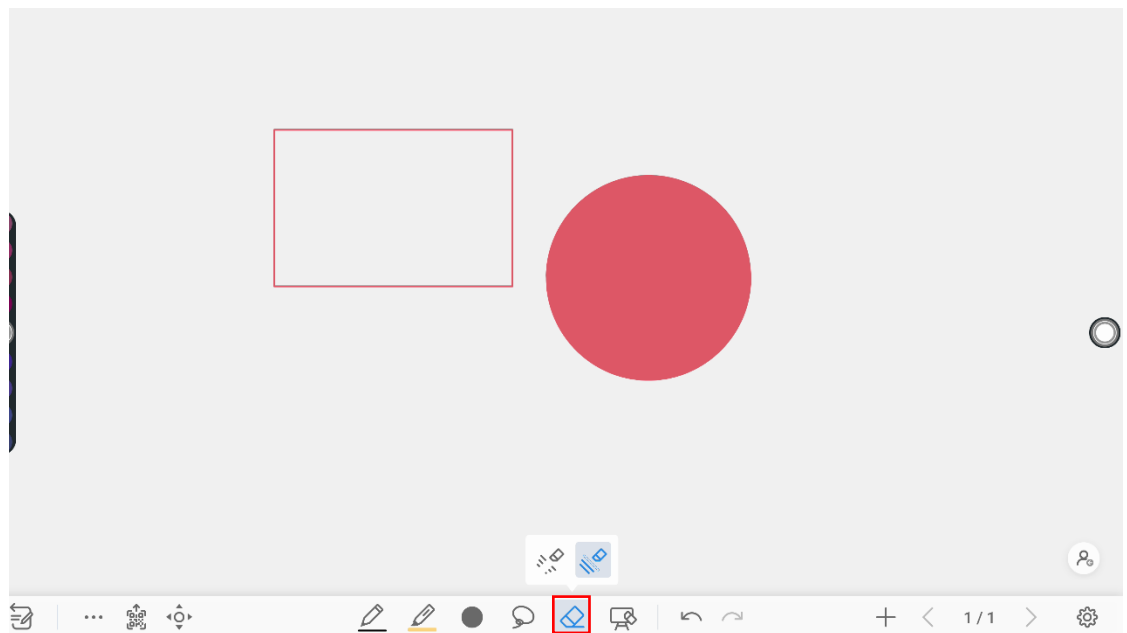

Clear All

On the Whiteboard page, tap  to show the pop-up windows to clear all content on the current page, as shown in the following figure:

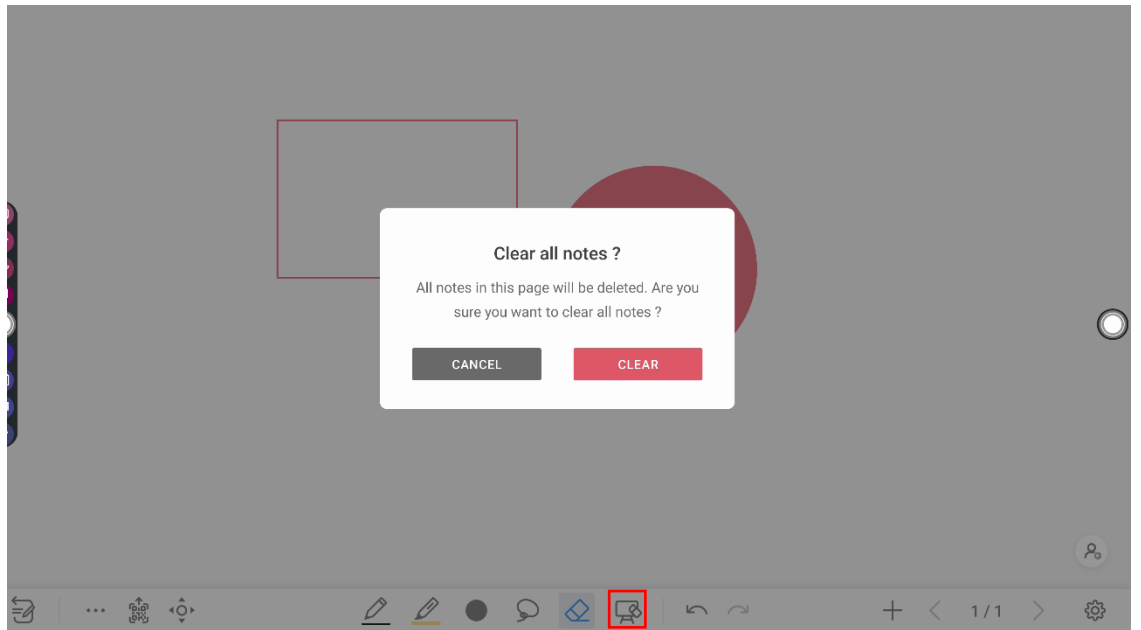

4.7.2 Page Operations

You can preview, select, and delete the writing page, you also can save the page to you USB Flash device or local files.

Page Preview

Tap **1 / 1** at the lower right corner in the whiteboard mode. All pages will be displayed. Tap one page to switch to that page for more operations, as shown in the following figure.



NOTE

Only 8 pages are displayed at once, and you can slide left by one finger to see more.

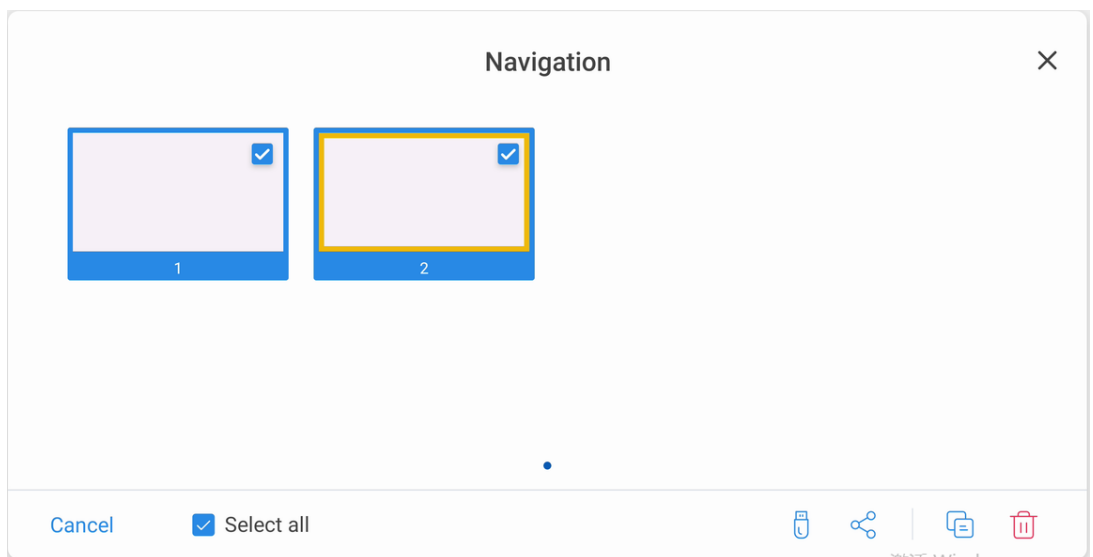





NOTE

Only 8 pages are displayed at once. You can slide right or left using one finger to see more.

Page Operation

On the **Navigation** page, you can select or delete writing pages according to requirements, as shown in the following figure:

- Tap  to select all pages.
- Tap  to save the writing pages to USB flash device.
- Tap  to share the writing pages to local file or AquaMail.
- Tap  to copy the page.
- Tap  to delete selected pages.

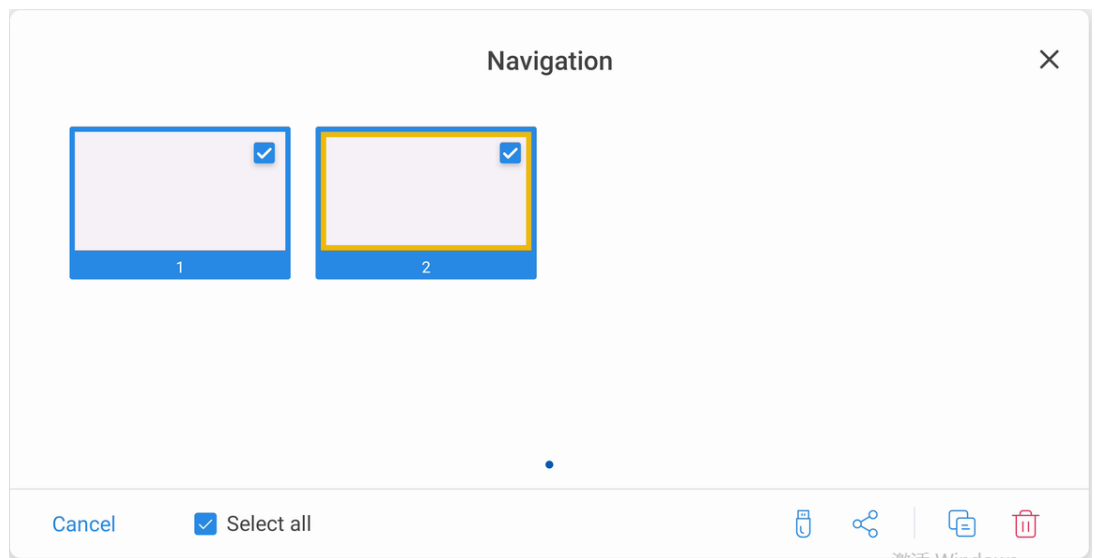

4.7.3 Whiteboard Setting

Tap the  icon to enter the settings bar, users can set the object recognition, action hint and default settings.

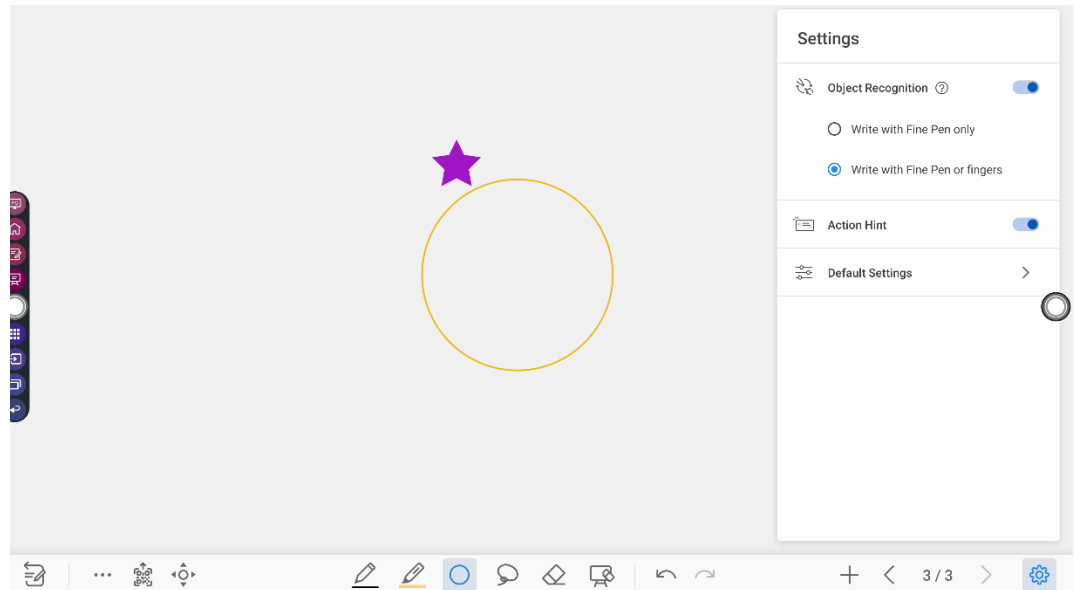

Object recognition

Users can drag the slider to enable the object detection function, tap  icon to view details functions, as shown in the following figure:

Example 1: Turn on write with Fine Pen only

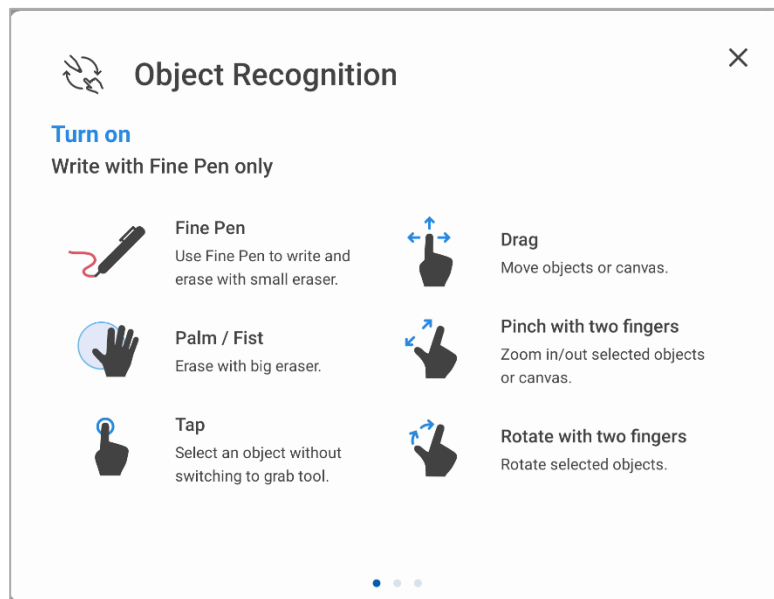

- Fine Pen (2mm): User Fine Pen to write and erase with small eraser.
- Fist/palm: identified as an eraser (100 pt).
- Tap: select an object without switching to grab tool.
- Drag: move objects or canvas.
- Pinch with two fingers: zoom in/out selected objects or canvas.
- Rotate with two fingers: rotate selected objects.

Example 2: Turn on write with Fine Pen or fingers

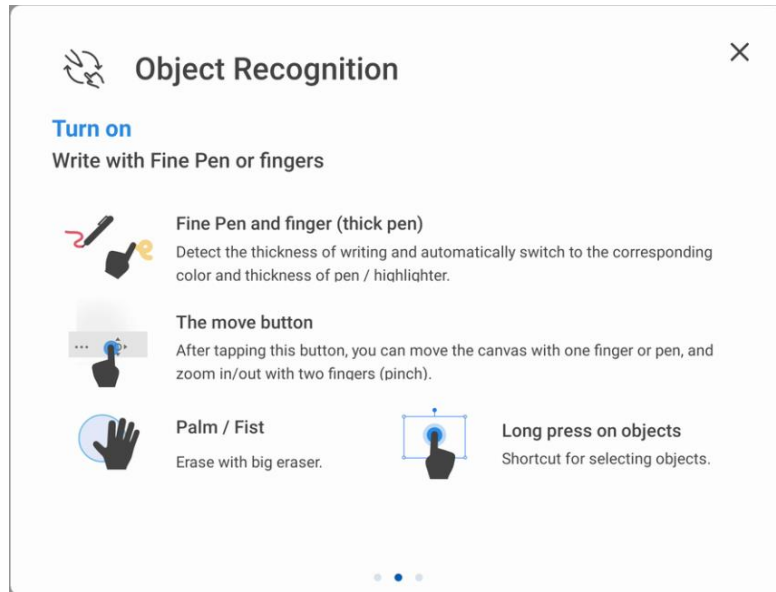

- Fine Pen and finger (thick pen): User Fine Pen or finger (thick pen) to write. System will detect the thickness of writing and automatically switch to the corresponding color and thickness of pen/highlighter.
- The move button: after tapping this button, you can move the canvas with one finger or pen, and zoom in/out with two fingers (pinch).
- Palm/Fist: Erase with big eraser.
- Long press on objects: shortcut for selecting objects.

Example 3: Turn off object recognition

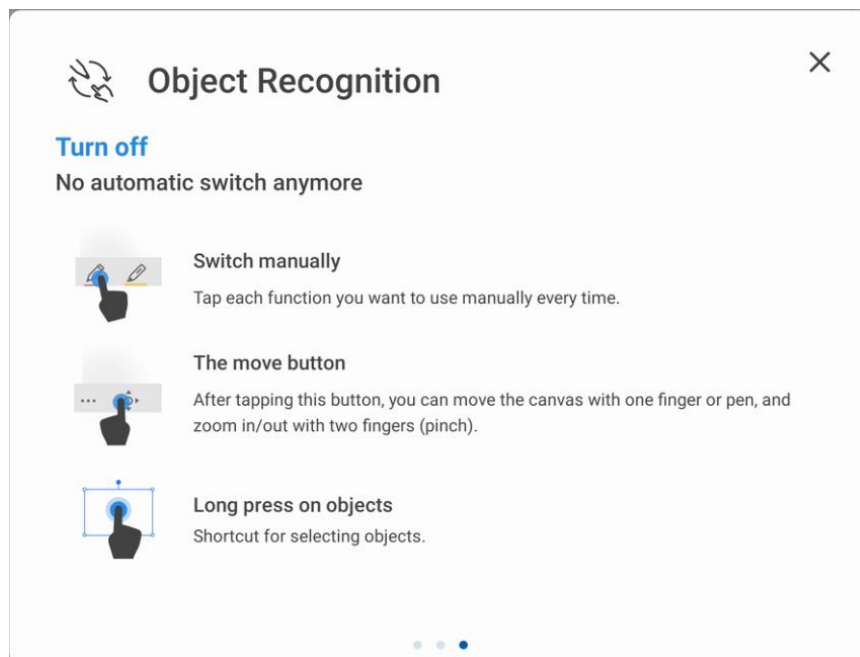

- Switch manually: Tap each function you want to use manually every time.
- The move button: after tapping this button, you can move the canvas with one finger or pen, and zoom in/out with two fingers (pinch).

- Long press on objects: shortcut for selecting objects.

Action hint: Drag the slider to enable the action hint.

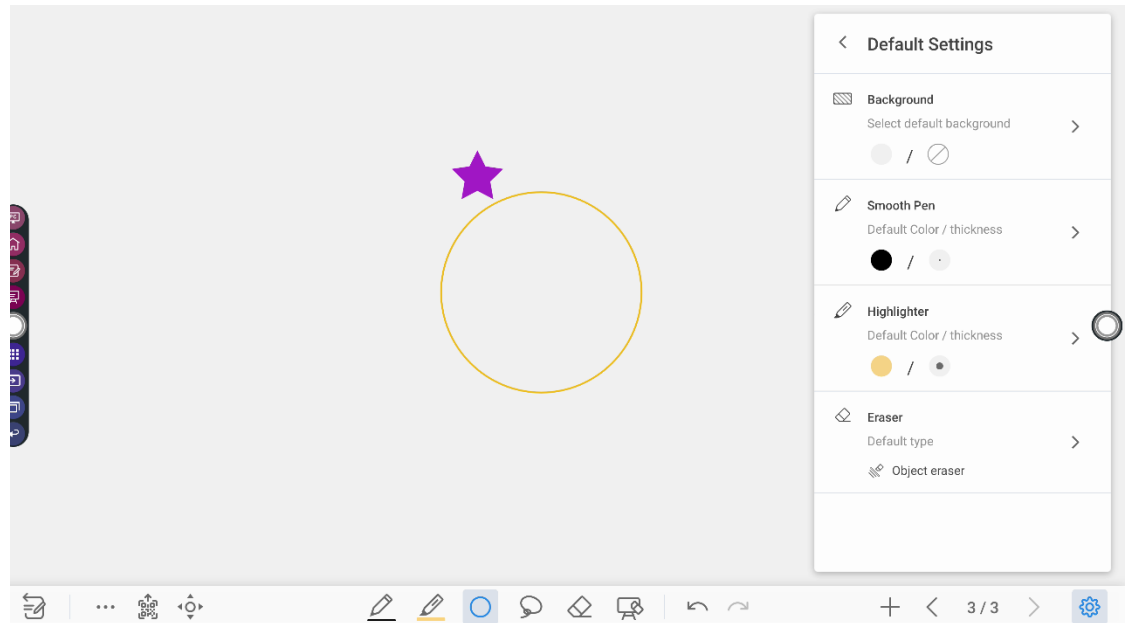

Default settings: Tap the button to enter default setting page, users can set whiteboard page background, change the color and thickness of Smooth Pen and Highlighter, change the default type of eraser, both object eraser and partial eraser can be set.



4.8 Annotation



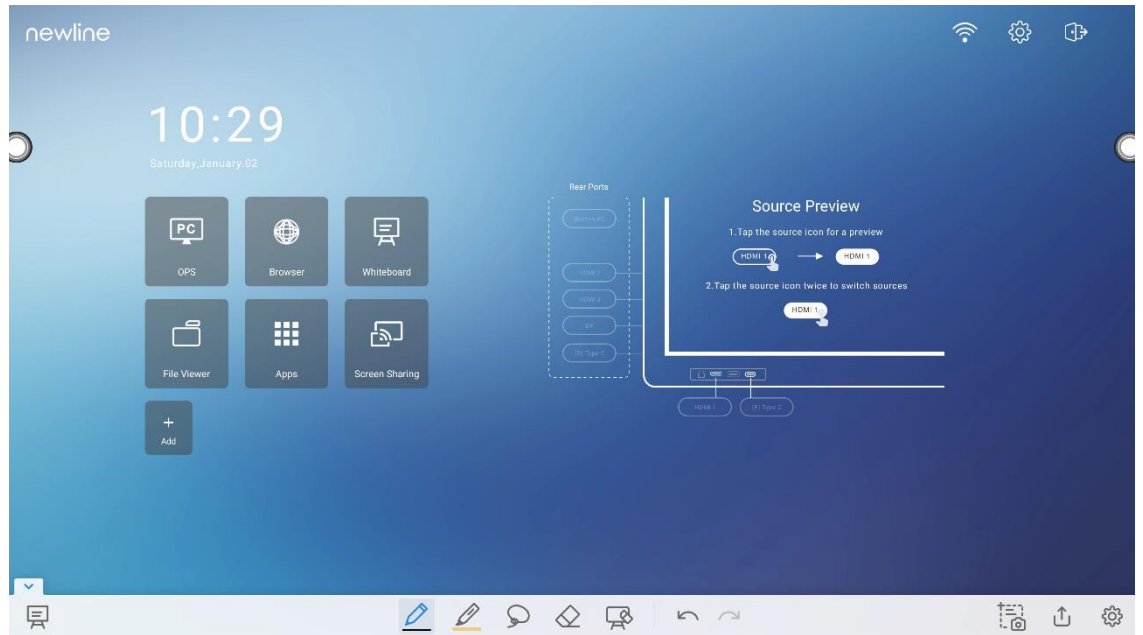

In annotation mode, the system generates a transparent layer at the top of the screen, and users can add annotations to the transparent layer until the annotation mode is exited.

The user can enter the annotation mode through the following two methods:

- Tap the “” icon in the sidebar;
- In the “**Whiteboard**” interface, tap the “” icon.





Take a Screenshot

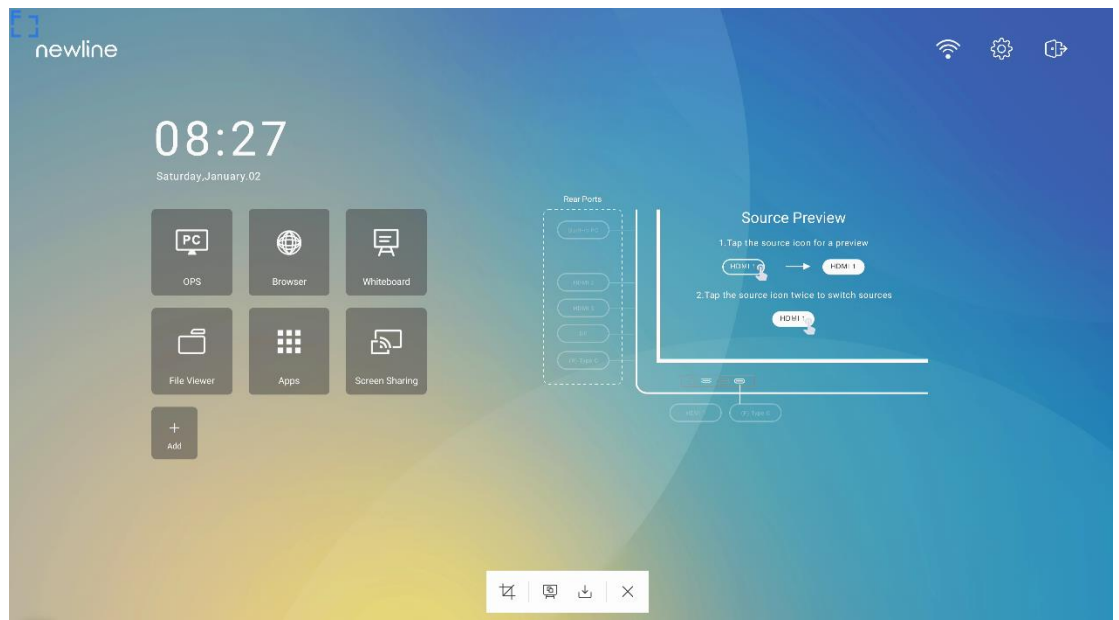

Tap  icon to enter take a screenshot interface, users can tap  icon to take a screenshot; tap  icon to switch to whiteboard mode; tap  icon to save screenshot, tap  icon to exit screenshot.



Save screenshot

Tap  icon to pop up save screenshot interface, you can save or share screenshot as following:

- Tap  to select all pages.

- Tap  to save the annotation pages to USB flash device.
- Tap  to share the annotation pages to local file or AquaMail.
- Tap  to delete selected pages.

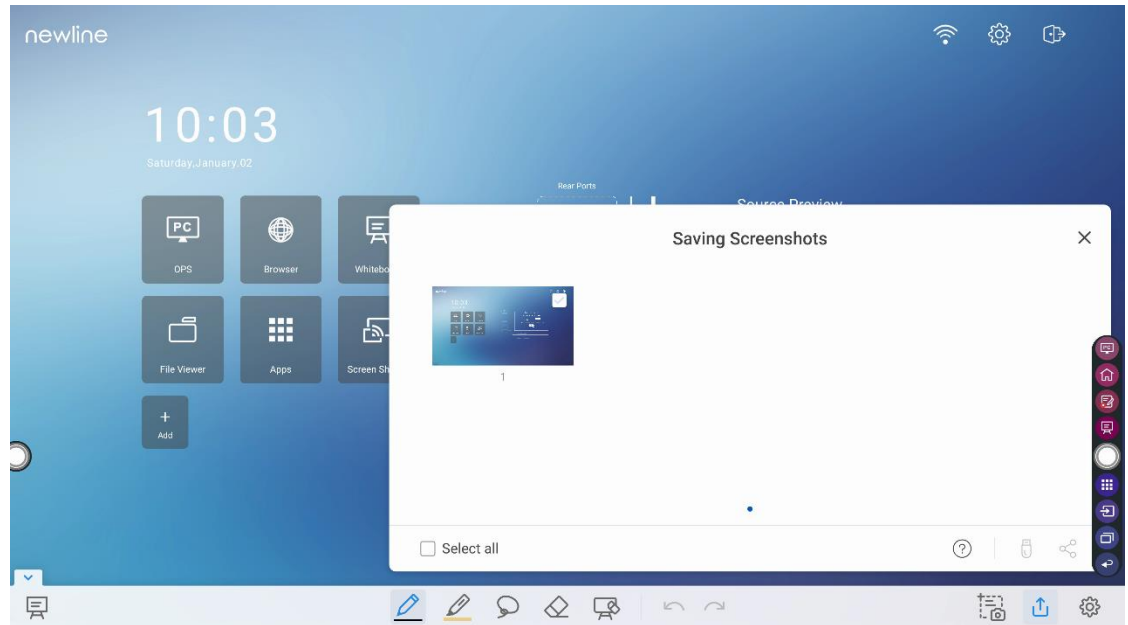

Notes:

You can select "**Internal storage > Pictures > Screenshots > image**" folder to view or get screenshots.

Settings

Tap  icon to pop up settings interface, you can turn on/off object recognition, Action hint and Auto screenshot. If auto screenshot setting is on, System will automatic take a screenshot when exiting the annotation mode.

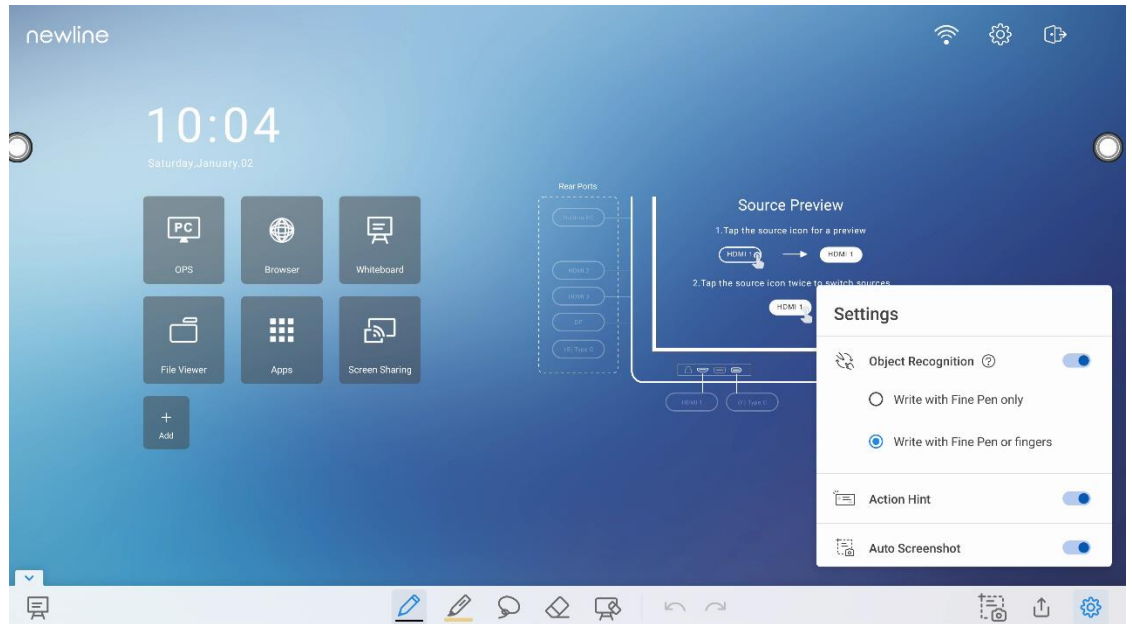

Notes:

If you need more details instruction, please refer to whiteboard setting.

4.9 File Management

The product supports connection to USB flash memory. In File Viewer application, you can preview all files in the internal storage and storage devices connected via USB ports and select, copy, paste, delete and search for files.

4.9.1 File Viewer Page

On the **Home** page, tap **File Viewer** to enter file commander interface, you can tap the icon to view pictures or files, as shown in the following figure:

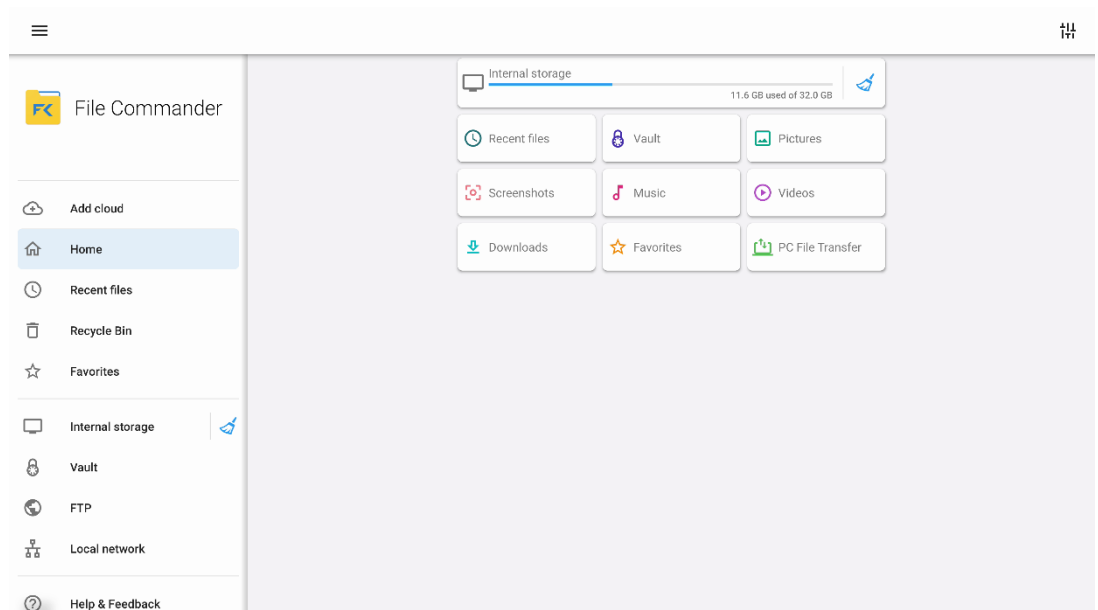

4.9.2 File Preview

Using the File Viewer application, you can tap the submenu on the left side to preview what files are on internal storage, external storage devices connected via the USB ports, cloud stored files, FTP uploaded files, and local network files, as shown in the following figure.

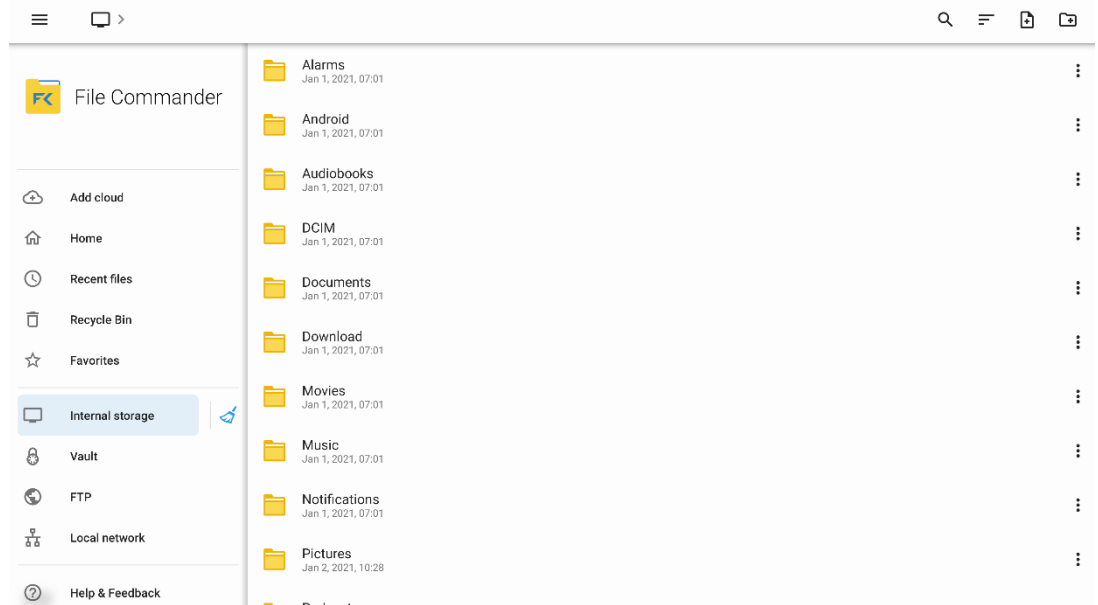

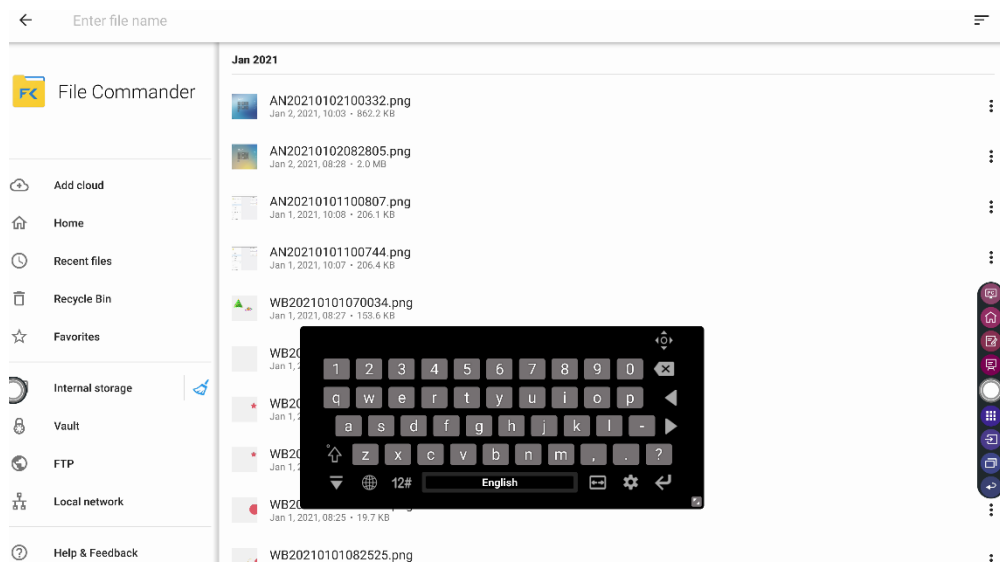

4.9.3 File Search

Enter the **File Viewer** application and tap . In the dialog box, enter the keywords in the search box. The system will display a list of files that match the searched for keywords.





4.9.4 File Filtering

You can tap the menu on the left side to display files by type, for example, whether the files is a document, a picture, music, a video, archived or was downloaded.

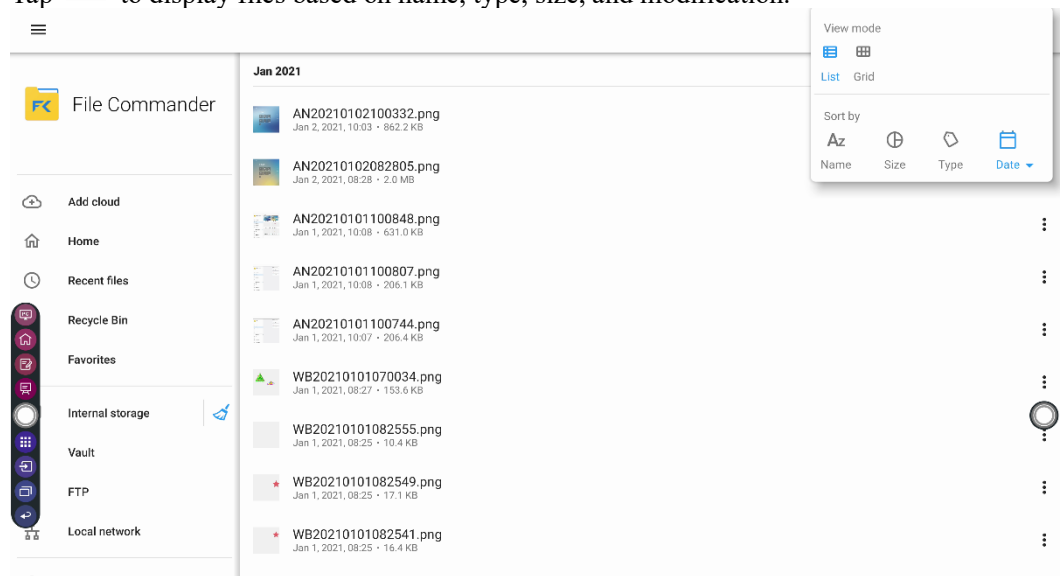
- The system supports two view modes: list and grid. You can tap  or  view modes.
- Tap  to display files based on name, type, size, and modification.



4.9.5 New Folder

Enter the **File Viewer** application, and tap  to create new file or tap  to create new folder, as shown in the following figure.

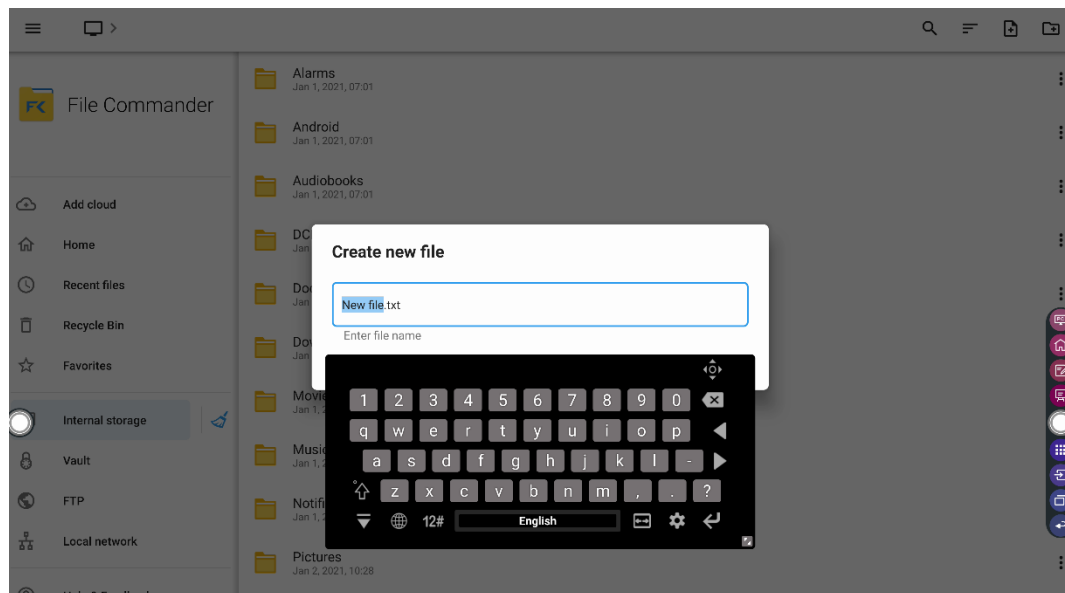

4.9.6 File Operation

Enter the File Viewer application. You can create folders according to requirements, select files by long pressing, and set wallpaper/copy/paste/delete. For details on other operation, tap  in the upper right corner for more operation.

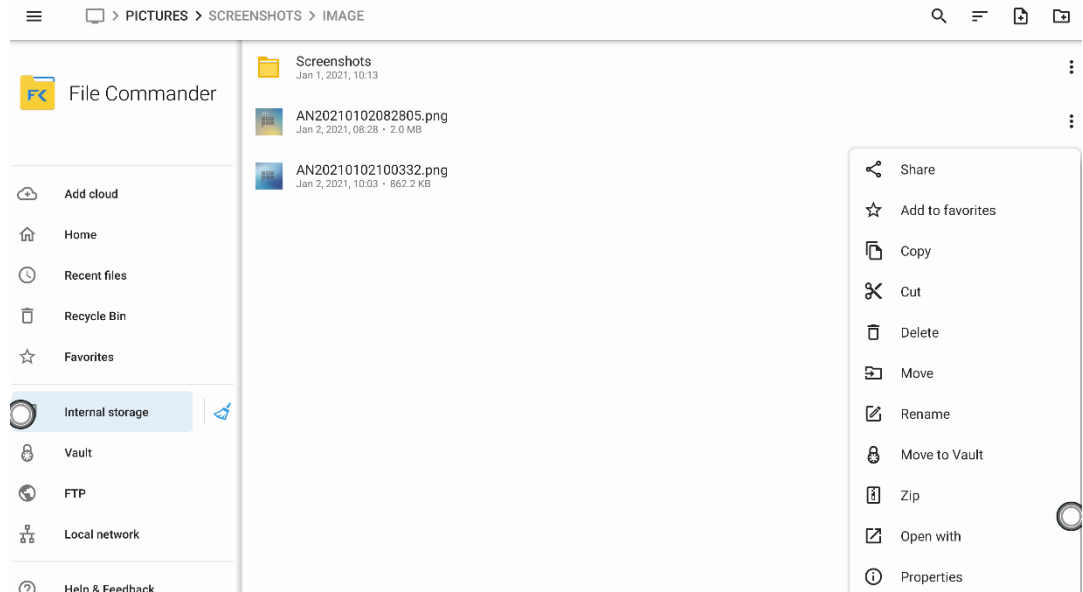

4.9.7 File Name

Under the "Internal storage > Pictures > Screenshots " folder in the File Manager, remote control screenshots of this meeting are saved.

Screenshots include annotation page screenshots, screenshot pages in the discussion mode are saved in the "Internal storage > Pictures > Screenshots > image" folder. Depending on the screenshots mode, picture naming is different. Picture files are named in the following of prefix + creation file.

Prefix name rule: WB (discussion mode page), AN (annotation page screenshot).

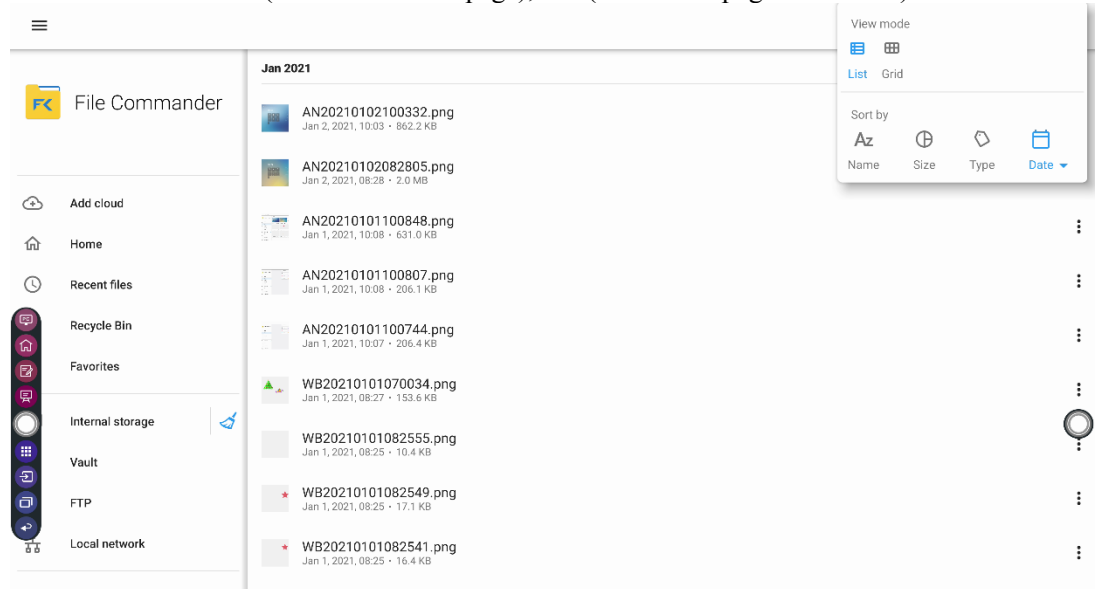

4.10 Browser

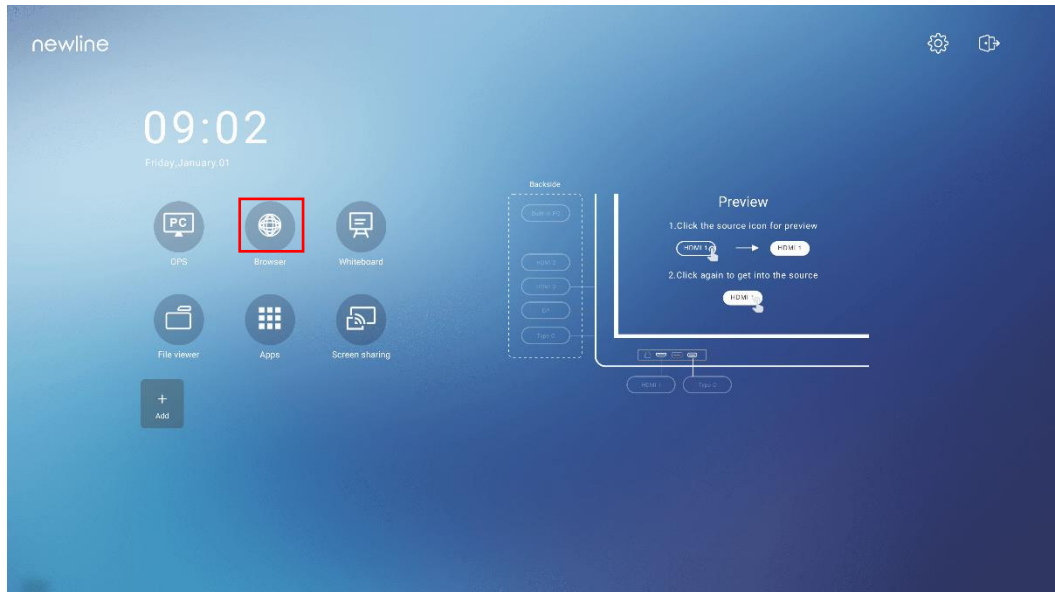

On the **Home** page, tap **Browser** to view web page, as shown in the following figure:





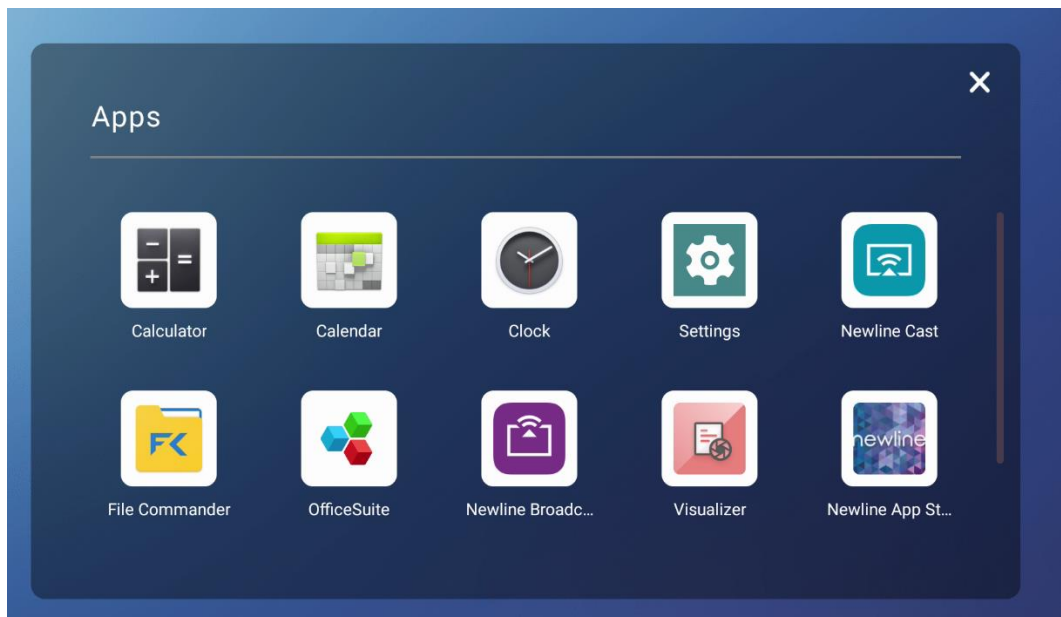









4.11 Apps folder

On the Home page, tap Apps. On the page that is displayed, all applications can be viewed. The following figure shows applications that the system is delivered with.



Name	Icon	Functions
Calculator		Tap this icon to enter the calculator application.
Calendar		Tap this icon to enter the calendar application.

Name	Icon	Functions
Clock		Tap this icon to enter the clock application.
Settings		Tap this icon to enter the settings application.
Newline Cast		Tap this icon to enter the Newline Cast application.
File viewer		Tap this icon to open the File Manager and you can explore all internal and external files on the screen.
Office suite		Tap this icon to enter the Office suite application. In this application, you can view office files, including excel, word, power point, and PDF files.
Newline Broadcast		Tap this icon to enter the Newline Broadcast application.
Visualizer		Tap this icon to enter the visualizer application.
Newline app store		Tap this icon to enter the newline app store application.
Newline display		Tap this icon to enter the Display diaplay application.
chromium		Tap this icon to enter the chromium application.
Aqual mail		Tap this icon to enter the email application and send files. Before sending files, you need to add an email account.
Newline classroom		Tap this icon to enter the newline classroom application.
Whiteboard		Tap this icon to enter the whiteboard application.



4.12 Add Shortcut

4.12.1 Add Shortcuts to Home Page

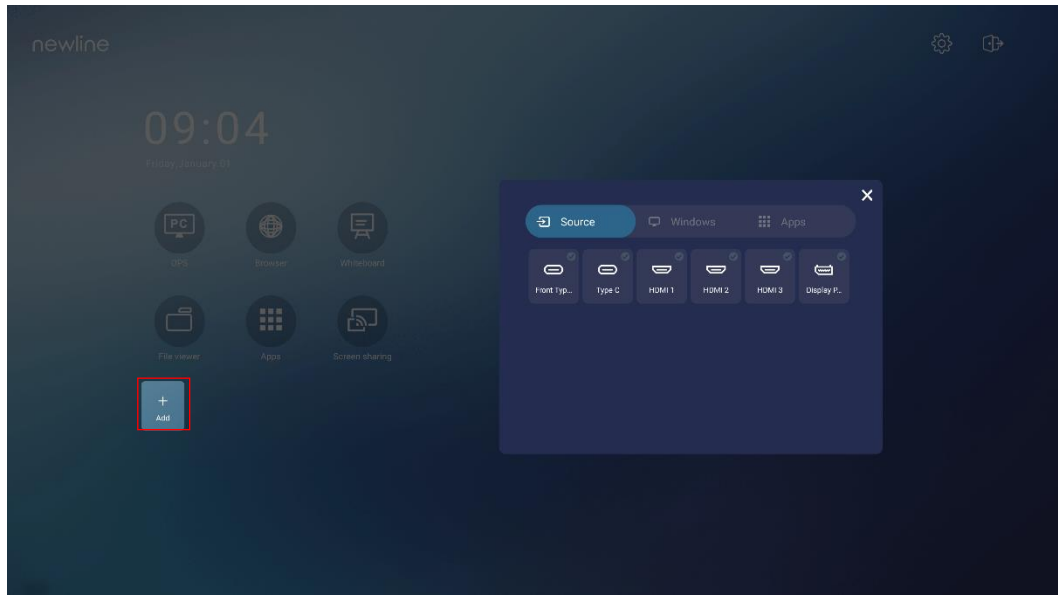
Step 1 On **Home** page, tap the  icon in the lower right corner to access the interface for adding shortcuts.



Step 2 Tap the icons across the top to switch the list between external signal sources, Windows software shortcuts and pre-installed apps.

- Tap  to view signal sources in Connection.
- Tap  to view the Windows software shortcuts that the Newline Assistant uploads to the embedded operating system. For details, see “**¡Error! No se encuentra el origen de la referencia.**”.

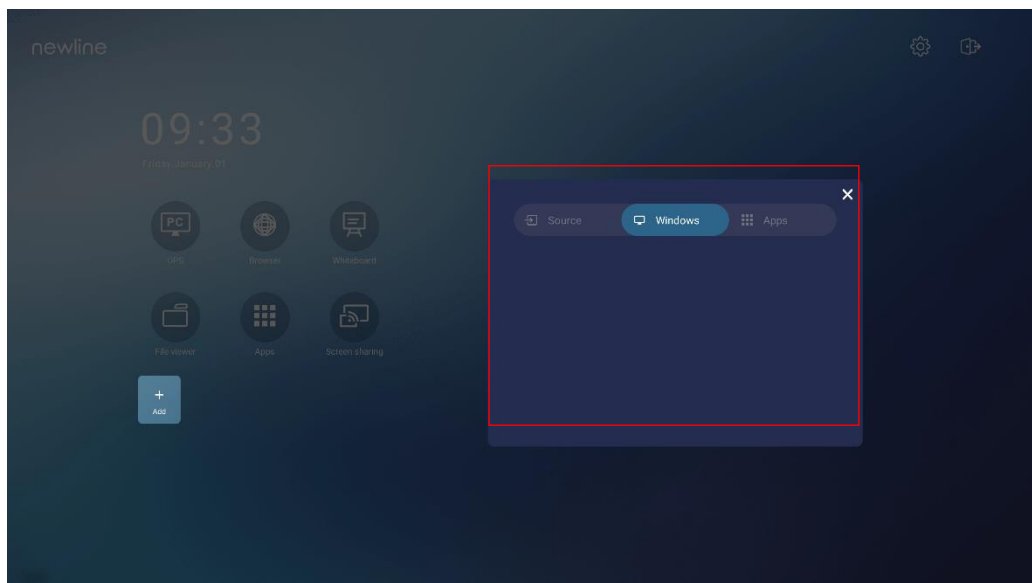

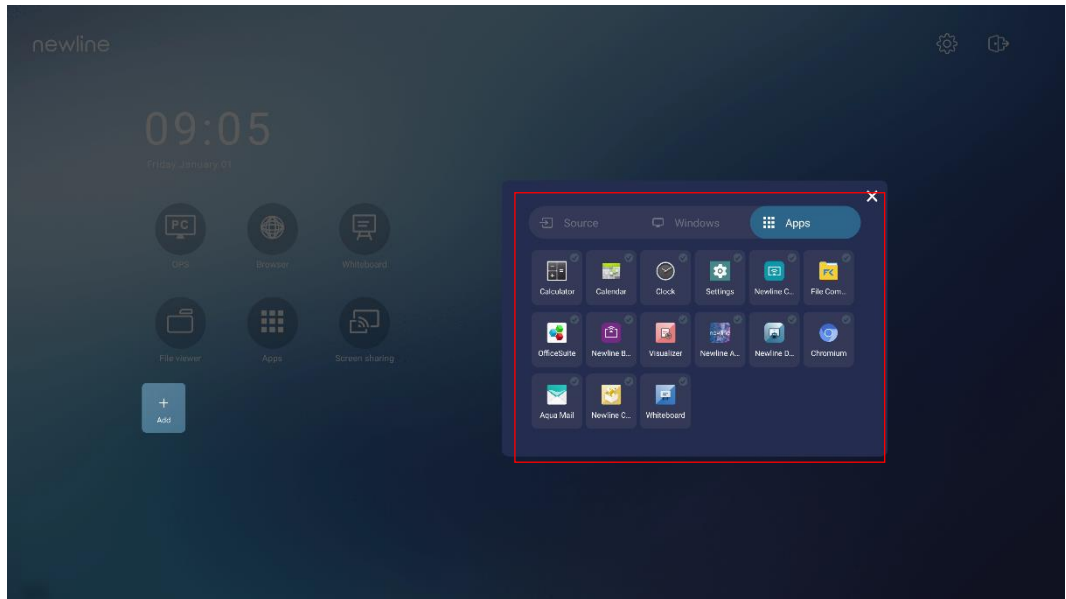

- Tap  to view all applications.

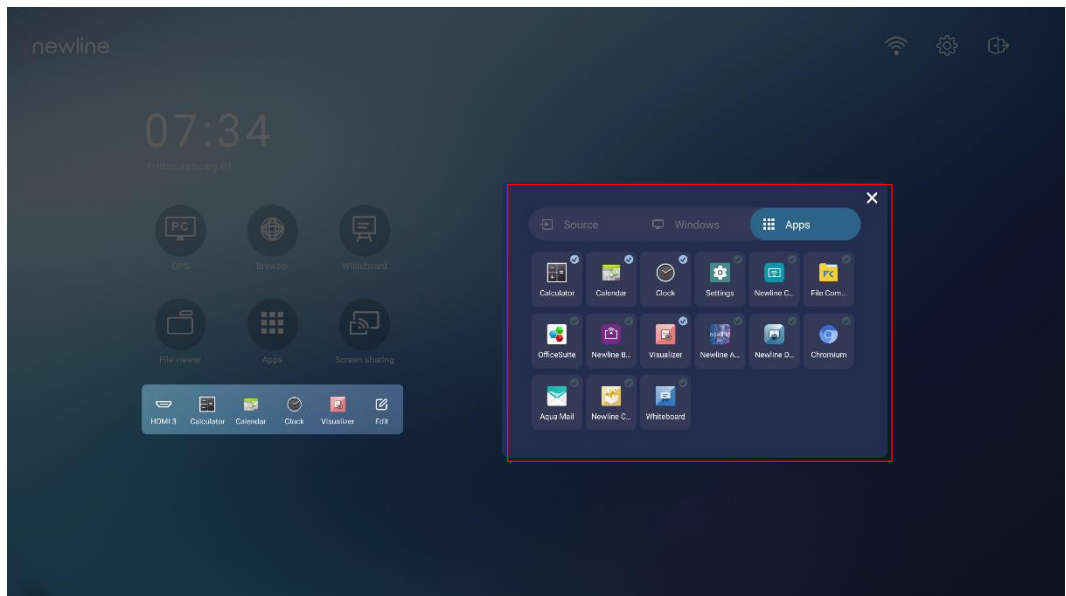

Step 3 Add or delete applications on the tab.

- In the list, tap the icon to add it as a shortcut on the Home page. A check icon will appear at the upper right corner of the shortcut icons. Up to 5 shortcuts can be added.
- Tap the icon with the check mark again. The check icon will disappear and the shortcut will be removed from the **Home** page.



Step 4 On the **Home** page, tap the shortcut icon and you can start the program/application or change to the external signal source. Tap the  icon to view adding shortcuts interface.





4.12.2 Add Quick Start Windows Programs in Smart System

Step 1 In Windows, run the **Newline Assistant** program and drag the software icons or folder shortcut icons that you want to add from the desktop or menu to the **Newline Assistant** window. The applications added or deleted through the Windows system will be automatically updated when the upload progress reaches 100%. If an application is not updated, tap  icon in the upper right corner to manually update the Newline assistant window on the embedded operating system.

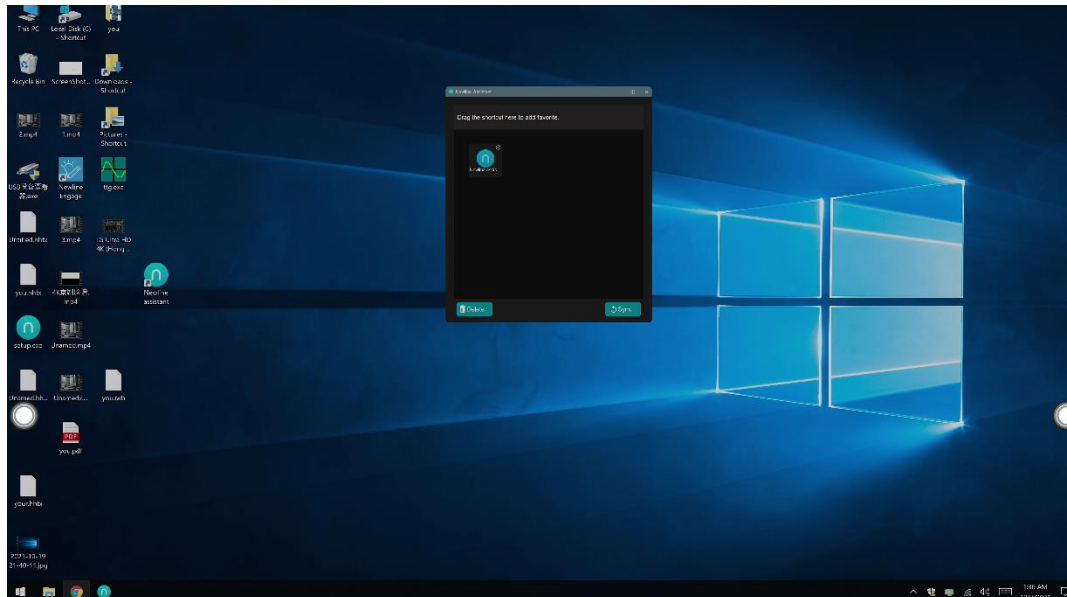
 **TIP**
Only folders and .exe file are supported.



Step 2 Tap  icon to return to the **Home Page**. Tap the  icon to view the shortcuts interface.

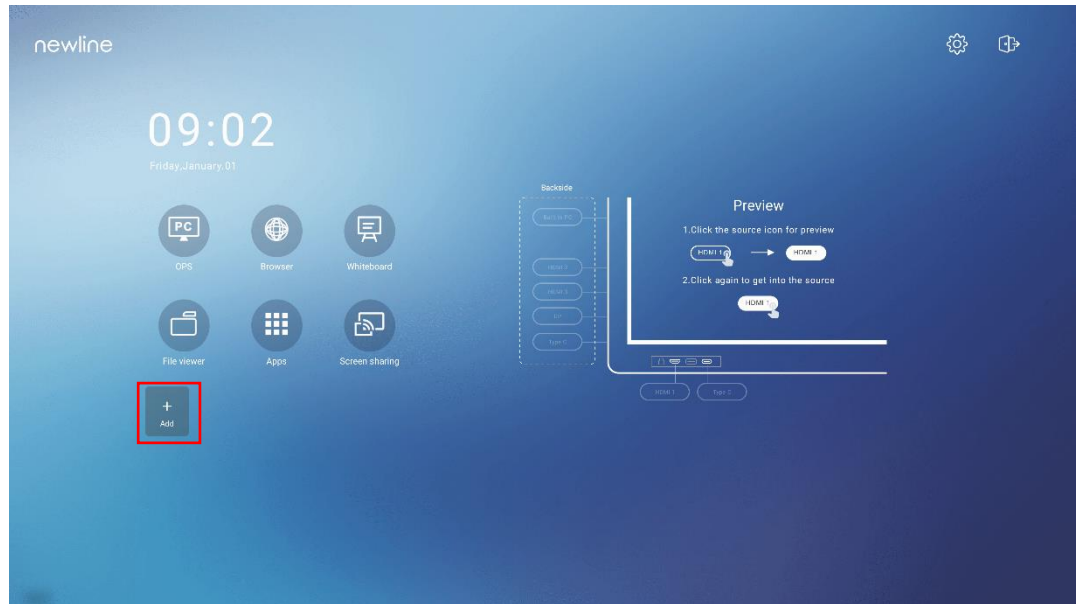

Step 3 On the shortcut setting page, tap  icon to view all the Windows software shortcuts added by the Newline Assistant in **¡Error! No se encuentra el origen de la referencia..**

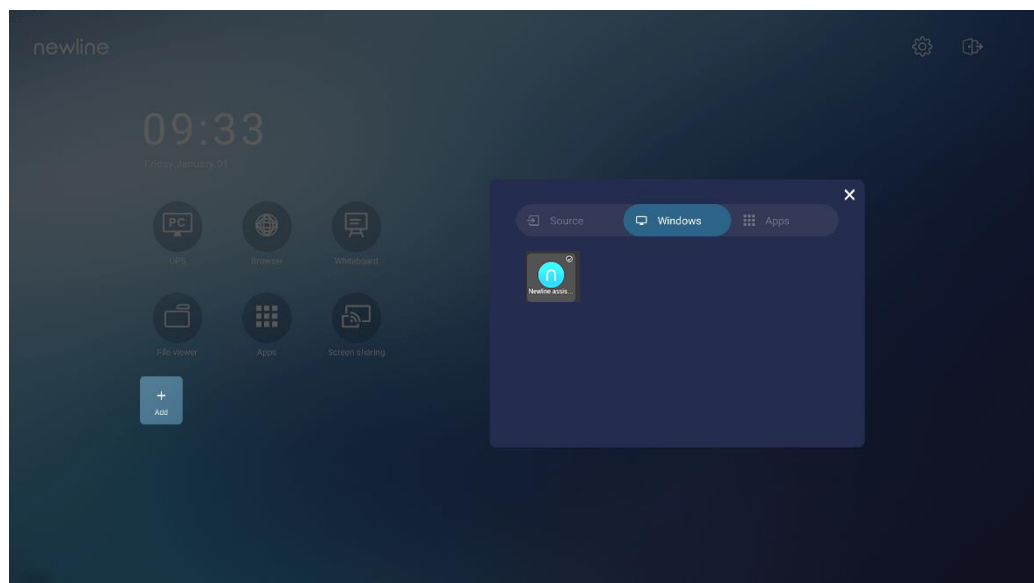

 **NOTE**

By default, the Newline Assistant application is added on the  tab.

Step 4 Tap the icon to add the shortcut on the Home page or tap again to remove it.

Step 5 Return to **Home** page. Tap the added shortcut to launch the Windows application.



4.13 Automatically Power Off

If the screen is left un-operated for a specified duration, it will be locked to guarantee your privacy. Choose Settings> Power Setting to set the duration. For details on the setting method, see "Power Setting".

After the screen is locked, if it is operated again within 120 seconds, the screen is unlocked. Otherwise, the screen enters the power off mode.

4.14 System Settings

Enter the system setting page using one of the following methods:

- Tap  on the **Home** page.
- Press  on the remote control.
- In the **Quick Setting Menu**, tap the  icon.

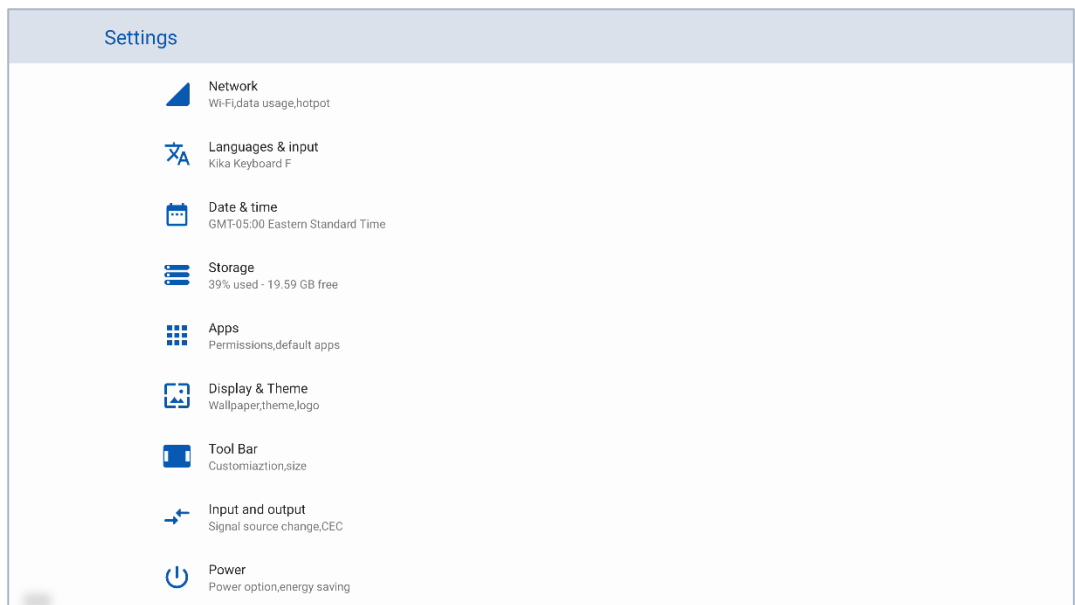

4.14.1 Network Settings

Enter the **Network** submenu to enable Wi-Fi or Ethernet, view network information, and enable the Wake on LAN function.

- **Wi-Fi:** Tap the corresponding button to enable the Wi-Fi function.
- **Ethernet:** When the RJ45 port is properly connected to the network cable, tap the corresponding button to enable the Ethernet function. User can View the MAC address, IP address, gateway, subnet mask, and DNS information. The user can customize settings to automatically obtain an IP address of the LAN or set a static IP address as needed.
- **Hotspot & tethering:** The user can customize relevant settings for portable Wi-Fi hotspot.

- **Wake on LAN:** Tap the corresponding button to enable **Wake on LAN** function.
- **Proxy:** Tap the item to view proxy server.

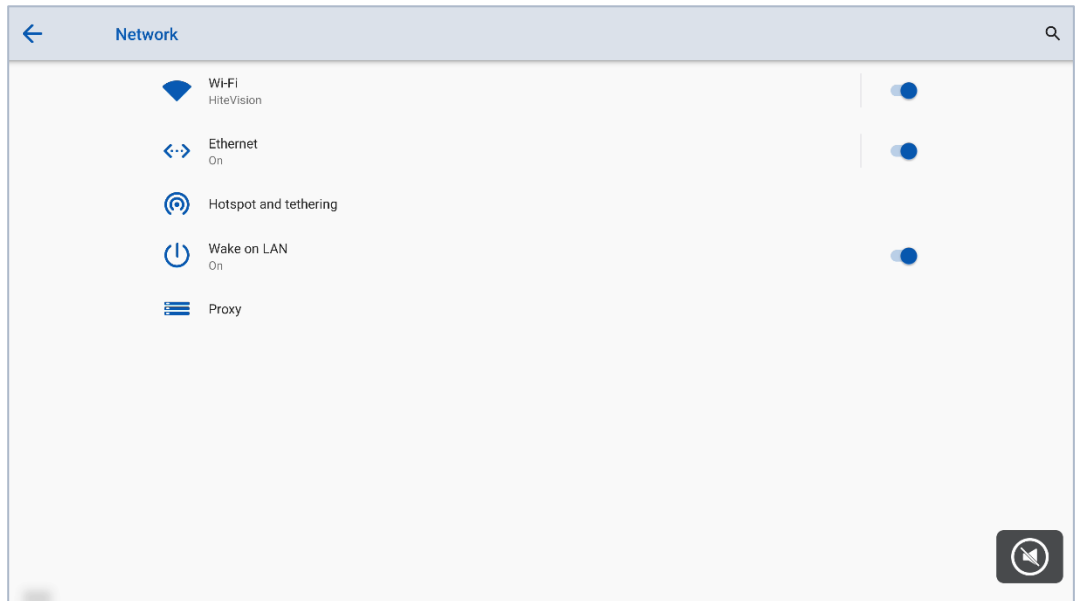

4.14.2 Language and Input

Enter the **Language & Input** submenu to set language and keyboard. The default input method of the system is **Kika Keyboard F**, and Physical keyboard must be enabled.

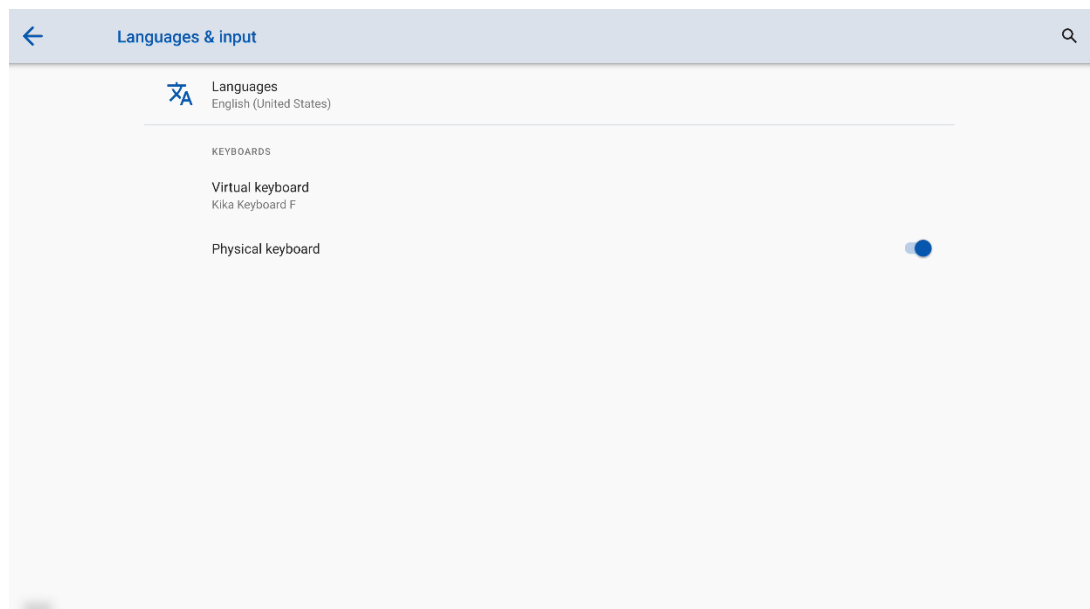

Setting kika keyboard F

Tap **Virtual keyboard** at the left side, select kika keyboard F to set a language in the **keybaord** dialog box.

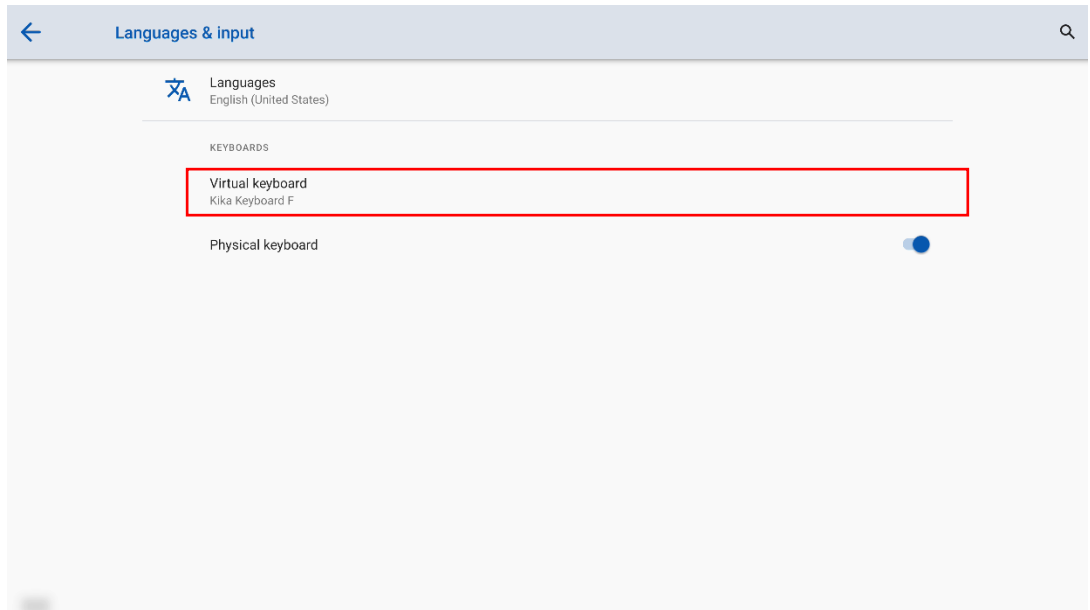

4.14.3 Date and Time Settings

Enter the **Date & Time** submenu to set the date and time. Before setting the date and time, users should tap **Time zone** to select local time zone.

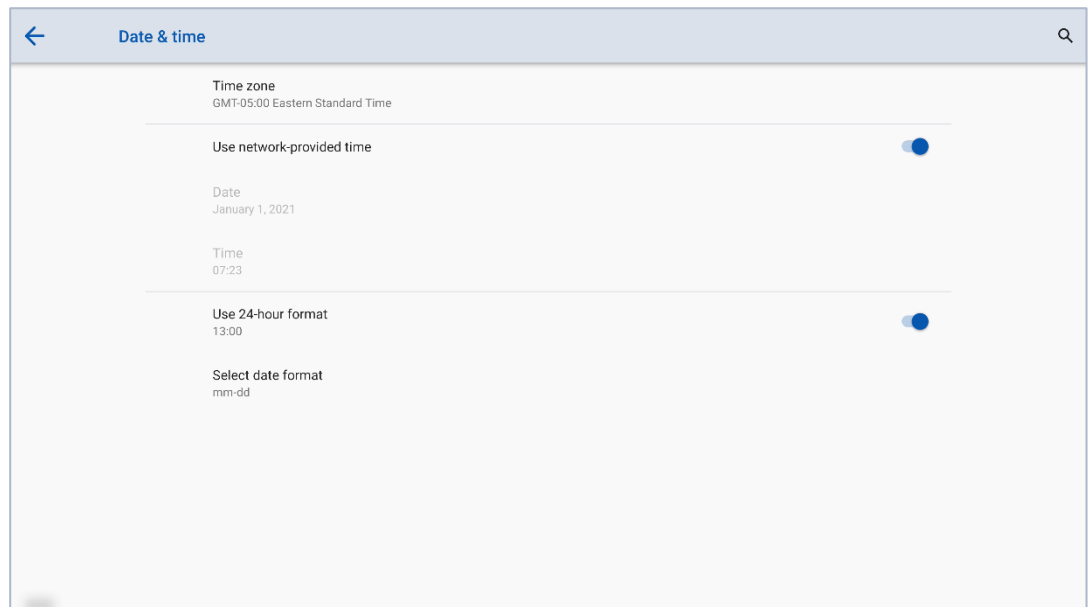

Setting a Date

You can automatically obtain the system date or customize a date.

- To automatically obtain a date, select **Use network provided time**.

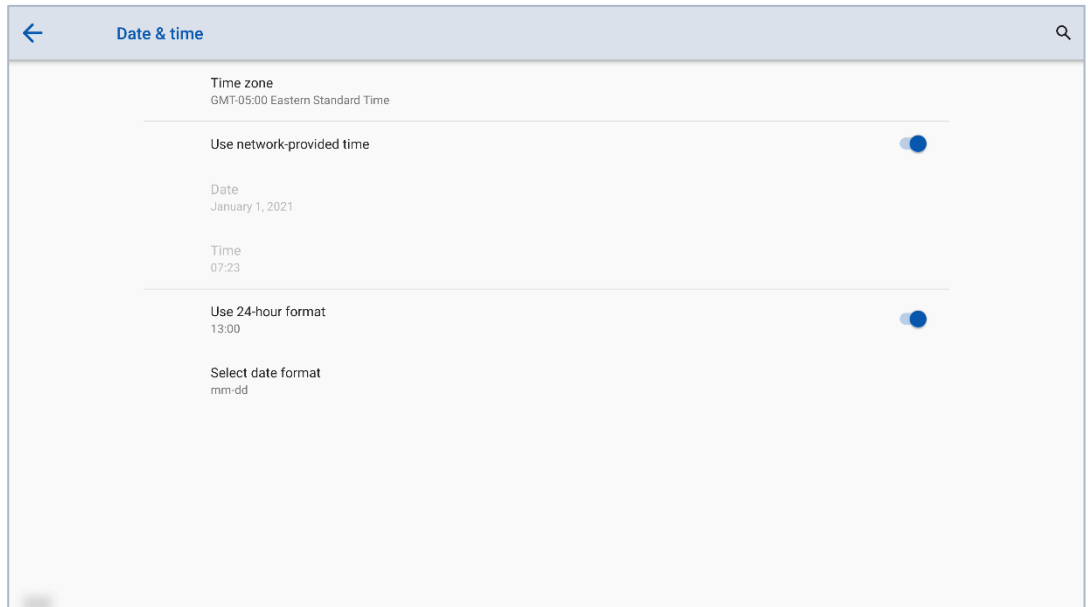

- To customize a date and date format, set them in **date** and **Select date format**.

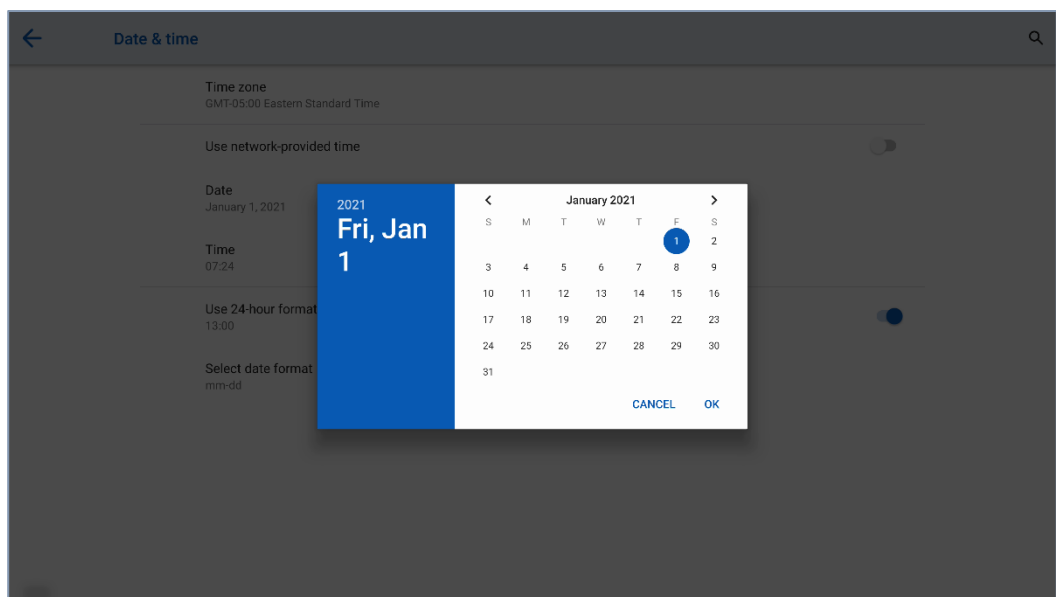

Setting Time

You can automatically obtain the system time or customize time.

- To automatically obtain time, select **Use network provided time**.

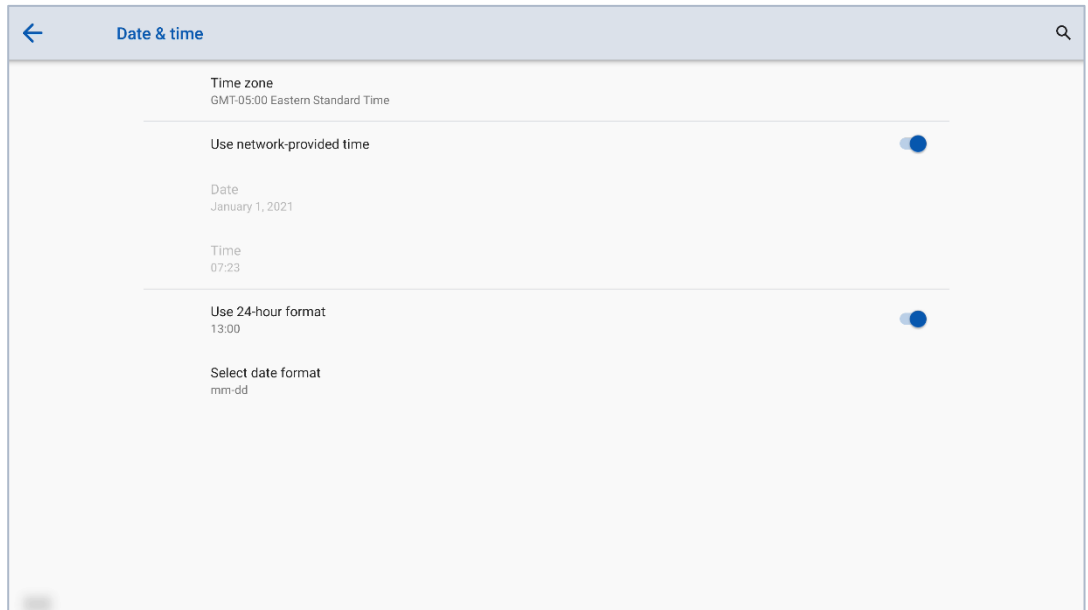

- To customize time and time format, set them in **time** and **Use 24-hour format**.

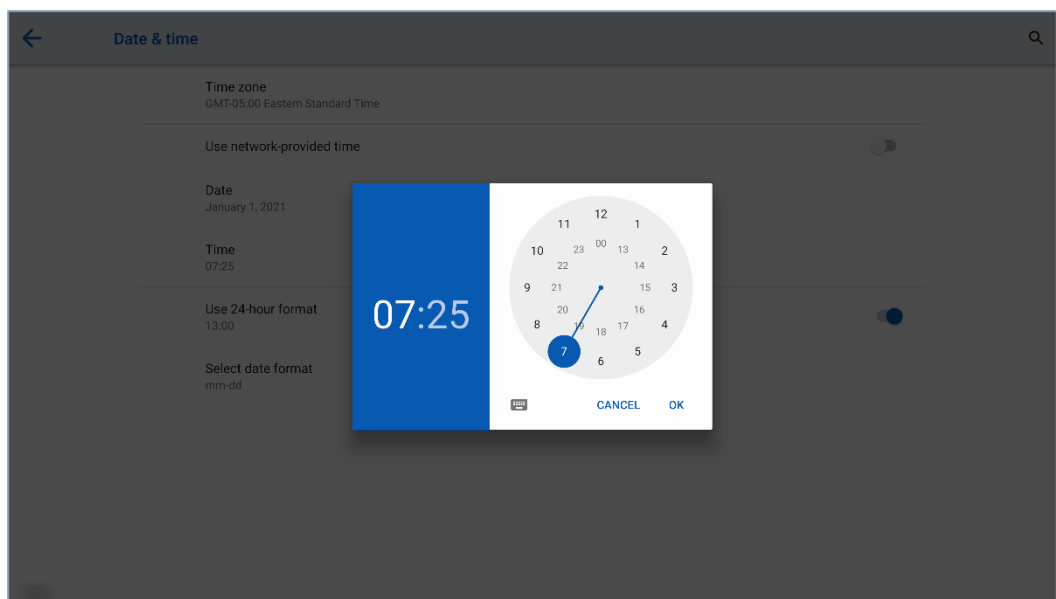

 **NOTE**

Time format will be 24-hours mode only when the **Use 24-hour format** is selected, otherwise time format will be 12 hours mode.

4.14.4 Storage

Enter the **Storage** submenu to view space distribution of the internal storage.

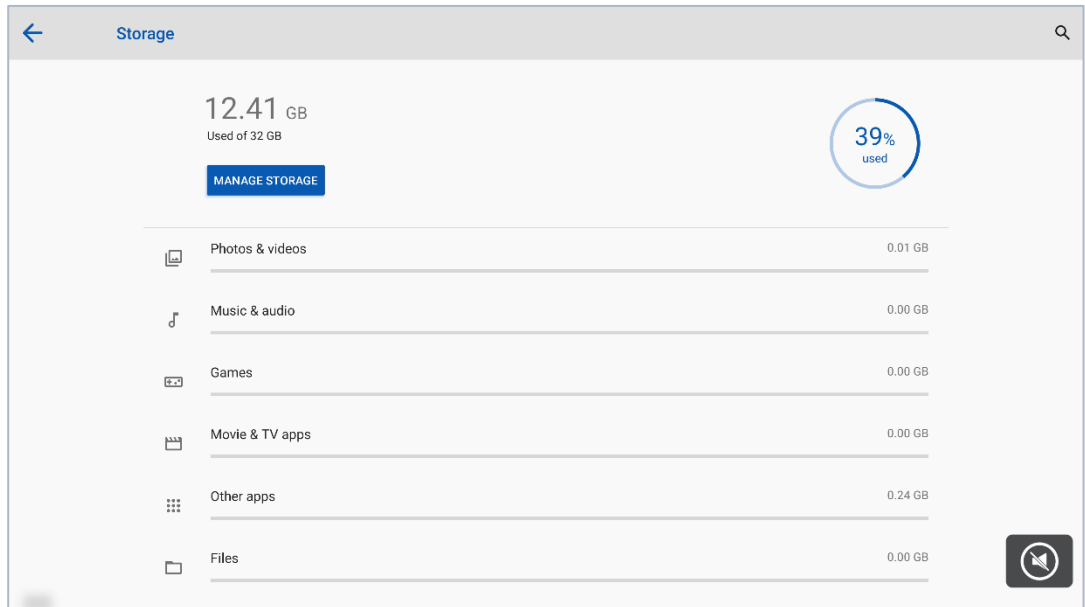

4.14.5 Applications

Enter the **Apps** submenu to view downloaded applications by type, running applications, and all applications.

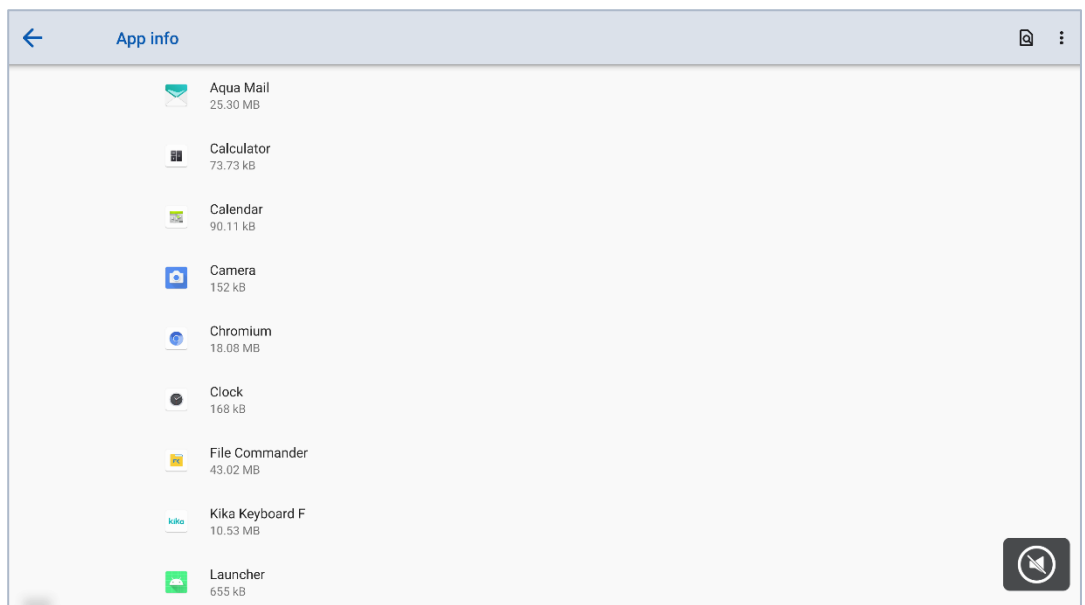

4.14.6 Display & Theme

Enter the **Display & Theme** submenu to set the theme, wallpaper, logo and font size.

- **Theme:** Standard, abstract, galaxy, forest, classic, five themes can be chosen;
- **Wallpaper:** Users can use default wallpaper, customize the wallpaper from file viewer;

- **Logo:** Tap the button to turn on/off the logo on the Home page;
- **Set logo:** Users can use default logo or customize the logo from file viewer;



4.14.7 Tool Bar

Enter the **Tool Bar** submenu to set whether to display the tool bar.

- **Left:** Tap to turn on/off the left tool bar.
- **Right:** Tap to turn on/off the right tool bar.
- **Quick settings:** Tap to turn on/off the tool bar on the Quick settings.



4.14.8 Input and Output Setting

Enter the **Input and Output** submenu to set the Home source and USB connection, enable new input source and CEC auto.

- **Starting source:** Customize settings to connect to the signal source after power on.
- **New input source:** After the **New input source** function is enabled, the system can automatically switch to the screen of the newly connected signal source.
- **CEC Auto Power On:** “**CEC Auto Power On**” is enabled, When the HDMI port of the panel is connected to a CEC device (such as a DVD), and both the CEC device and the panel are turned off, if the CEC device is turned on, the panel automatically turns on after receiving command from the CEC.
- **CEC Auto Power Off:** “**CEC Auto Power Off**” is enabled, When the HDMI port of the panel is connected to a CEC device, and both the CEC device and the panel are turned on, if the panel is turned off, the CEC device automatically turns off after receiving the command; if the CEC device is turned off, the panel automatically turns off after receiving the command.
- **HDMI 1/2 & DP EDID switch 2.0:** Tap the button to choose the HDMI1.4 or HDMI 2.0.

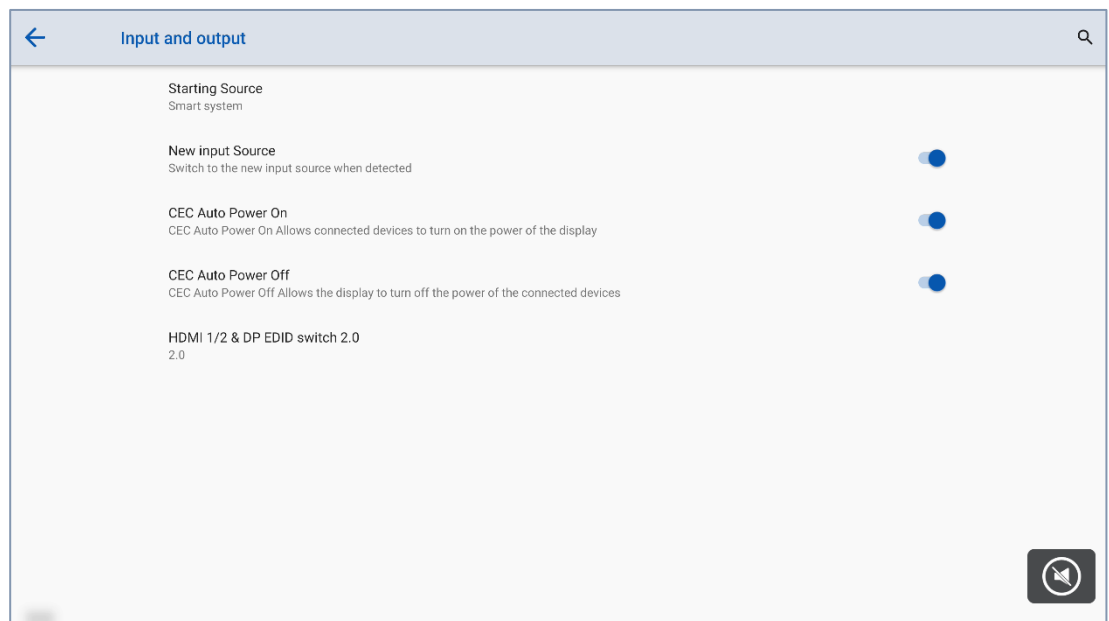

4.14.9 Power Setting

Enter the **Power** submenu to set power on or power off as following:

- **Auto power on/off:** Tap the button to enable the function, users can set the power on/ off on time.
- **Power on/off on time:** Set the power on/ off time, system will automatic power on/off on the customize time.
- **Energy saving:** Set a duration after which the screen enters the lock mode if the screen is left un-operated.
- **Power option:** Set the system enter power off or sleep mode when users press power button.

- **Sleep and touch to wake up:** Tap the button to enable the function, users can touch the screen to wake up the system from sleep mode.

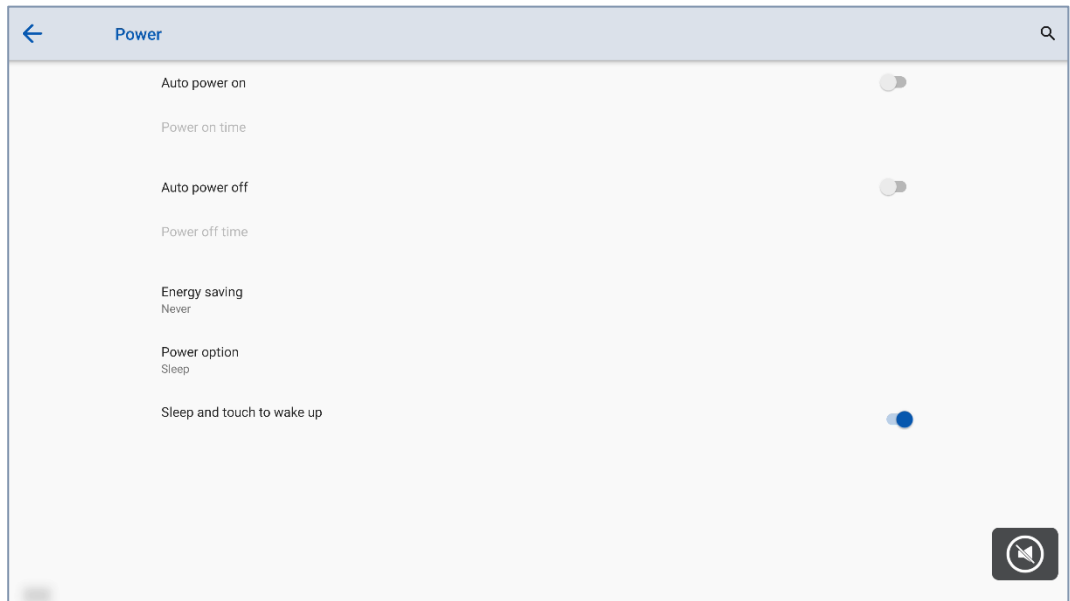

- To set the automatic power on time, select **Auto power on**, and set the power on time in **Power on time**, as shown in the following figure.

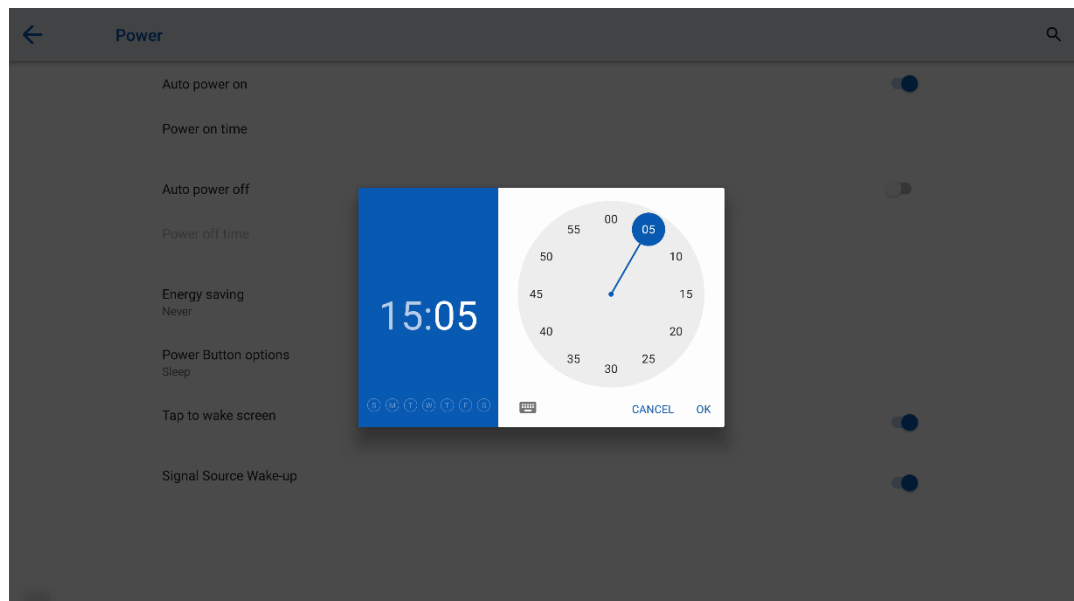

- To set the automatic power off time, select **Auto power off**, and set the power off time in **Power off time**, as shown in the following figure.

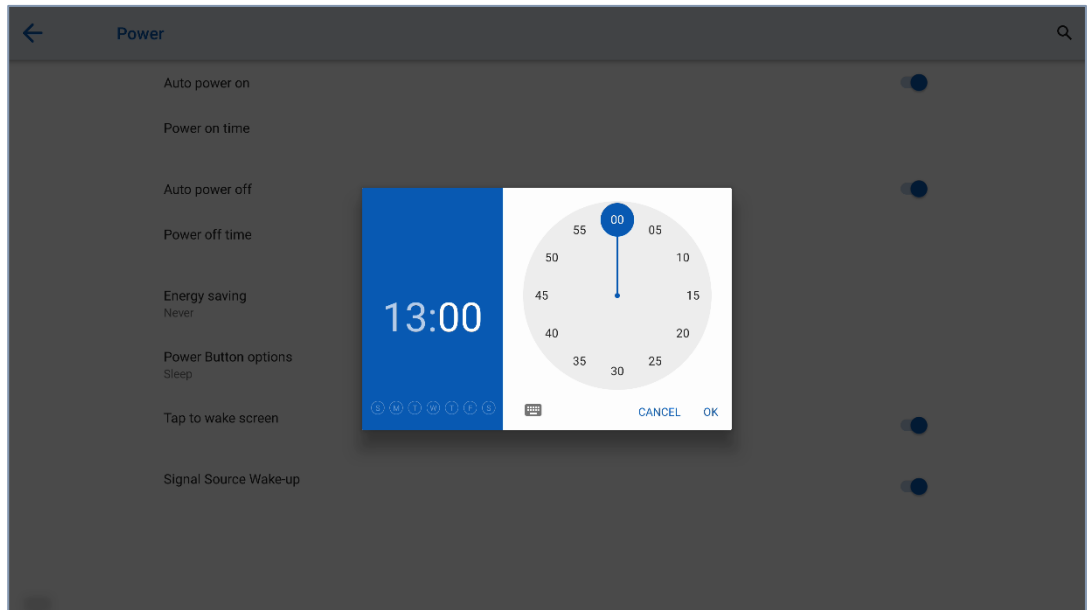

- To set the energy saving time, tap **Energy saving**. In the dialog box that is displayed, set a duration after which the screen enters the lock mode if the screen is left un-operated. After the screen is locked, if the user does not operate the screen within 120s, the screen enters the power off mode. The duration can be set to **30 MIN**, **60 MIN**, **90 MIN**, or **NEVER**. You can also customize this duration and the range is 3 minutes to 480 minutes.



NOTE

NEVER indicates that the automatic power off mode function is not enabled.

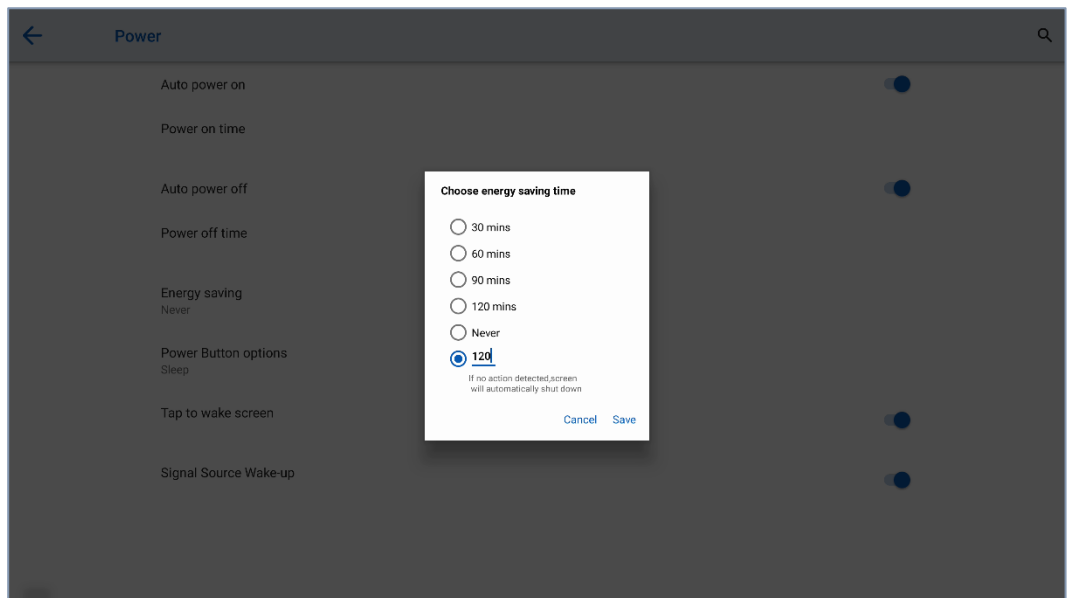

4.14.10 Screen Eye Filters

Enter the **Screen Eye Filters** submenu to set **Writing Mode Filter**, **Brightness Mode Filter** and **Bluelight filter**. If only the **Bluelight filter** setting is on, the **Filter level** can be set.

When **Writing Mode Filter** is on, the display will change whiteboard brightness under writing mode. When **Brightness Mode Filter** is on, the display will change screen brightness based on ambient light. When **Bluelight filter** is on, the filter level tints your screen abmer, this makes it easier to look at your screen or read in light.

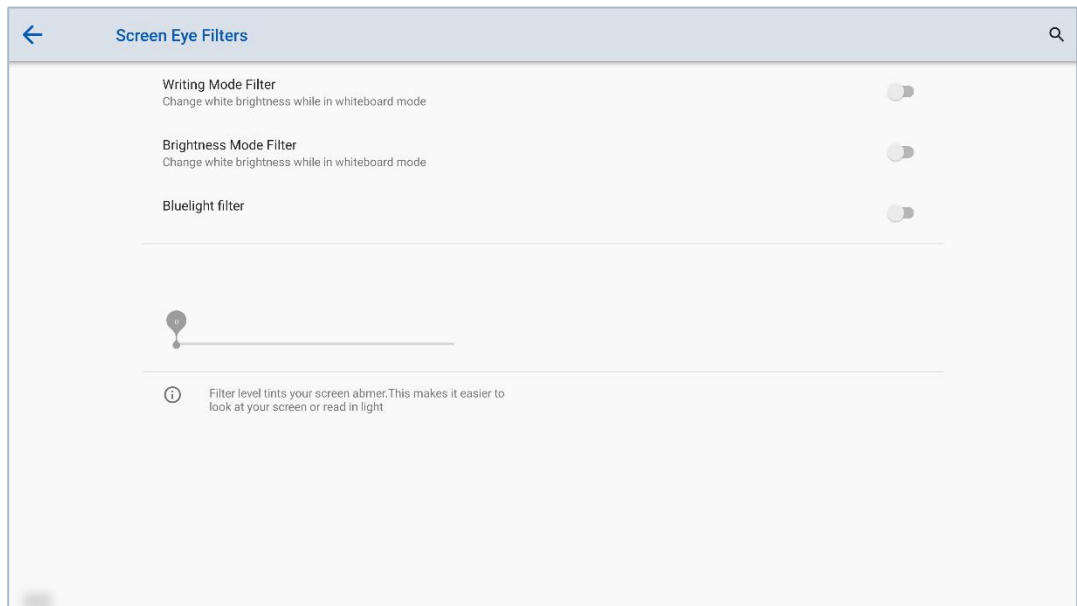

Note:

Studies have shown that just as the ultra-violet rays can cause eye damage, the shortwave-length blue light rays from displays can cause eyestrain, retina damage, and affect vision over time. Newline Blue Light filter is an eye protection feature that can reduce the blue light. TT-6521Q /TT-7521Q /TT-8621Q has obtained this certification.

For protecting your eyes against prolonged display use, we highly recommend you to do the following:

- Let your eyes rest for 10 minutes after 2 hours of continues use.
- Roll your eyes upward towards your eyebrows, and then roll your eyes in a large circle every few hours.
- For every 20 minutes of display viewing, look into the distance for 20 seconds.
- When your eyes get sore, close your eyes for a minute.

Using Low Blue Light

Decreasing the blue light emitting by the Interactive Flat panel display reduces the blue light exposure to your eyes.

The Interactive Flat panel display use a low blue light panel default setting mode, that when used in the default setting mode, is certified by TUV to reduce blue light output and create a more relaxing and less stimulating image while reading content on the screen.

The hardware solution was developed to control the blue light range emission. Instead of reducing the total blue range, the selected range reduction does not impact CCT and display

color. It exposes users to less blue light emission while letting them enjoy good color on the display.

4.14.11 System

Enter the **System** submenu to see system version information and admin mode.

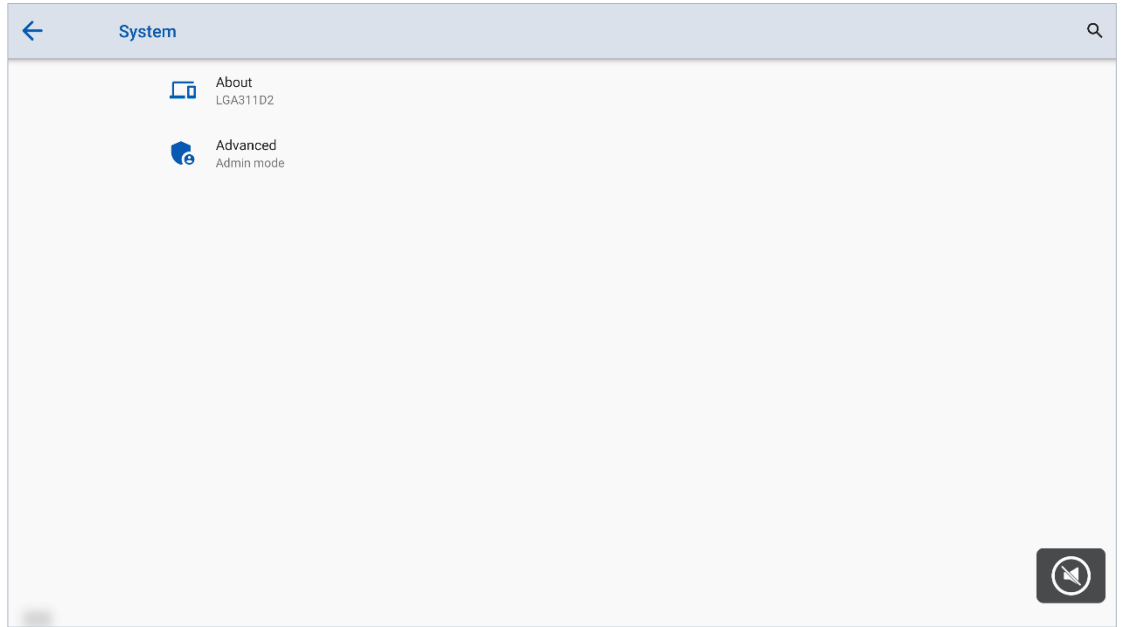

About

Enter **About** to check the system info such as Model, serial number, firmware version...etc.



Advanced

For enhance the security, and the better user experience, we collect the settings about the security to the admin mode.

There are two ways to enter the admin mode:

- Go to Settings → System → advanced, tap the admin mode, then use the floating keyboard on the screen, enter the passkey 2364606633 to get into the admin mode.

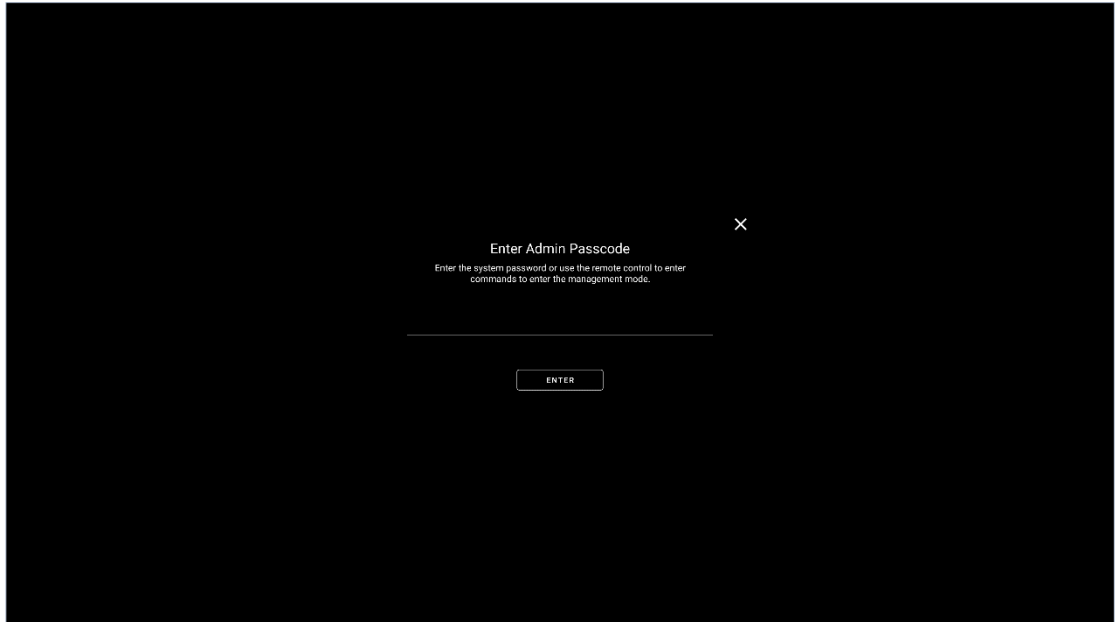

- Use remote control and press: **UP> DOWN> UP> DOWN> LEFT> RIGHT> LEFT> RIGHT> Brightness+> Brightness-**, then you will see the admin mode pops up. You can press the X button at the top of the right corner to exit it, or it will close automatically if no operation detected after 5 minutes.

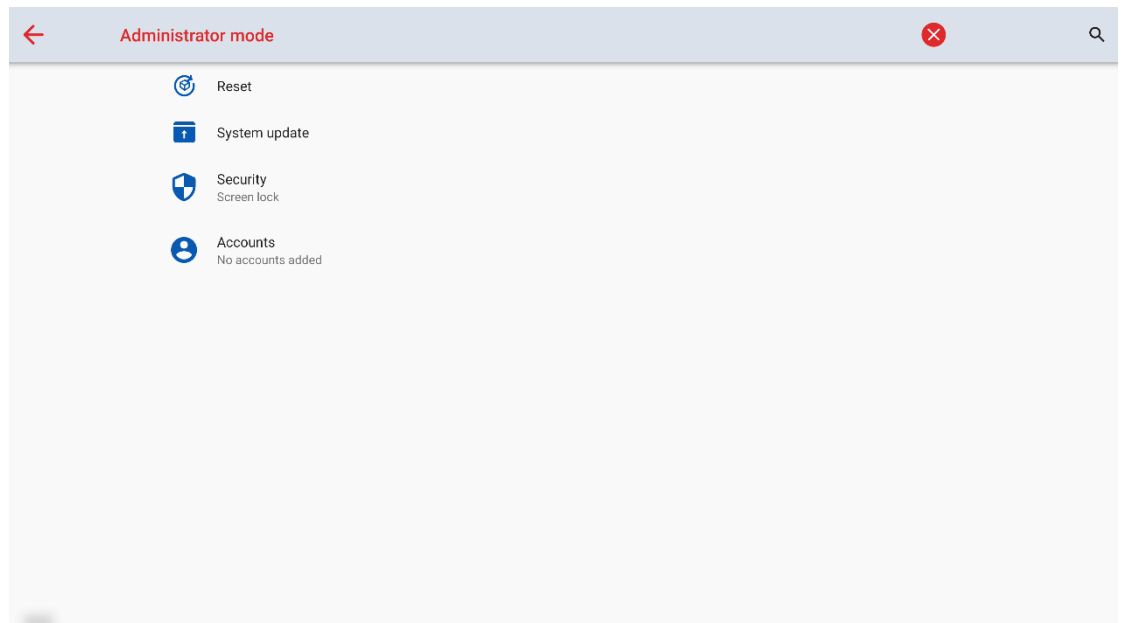

1. Reset

Enter the **Reset** submenu to set about the network settings reset, reset app preference and factory data reset.

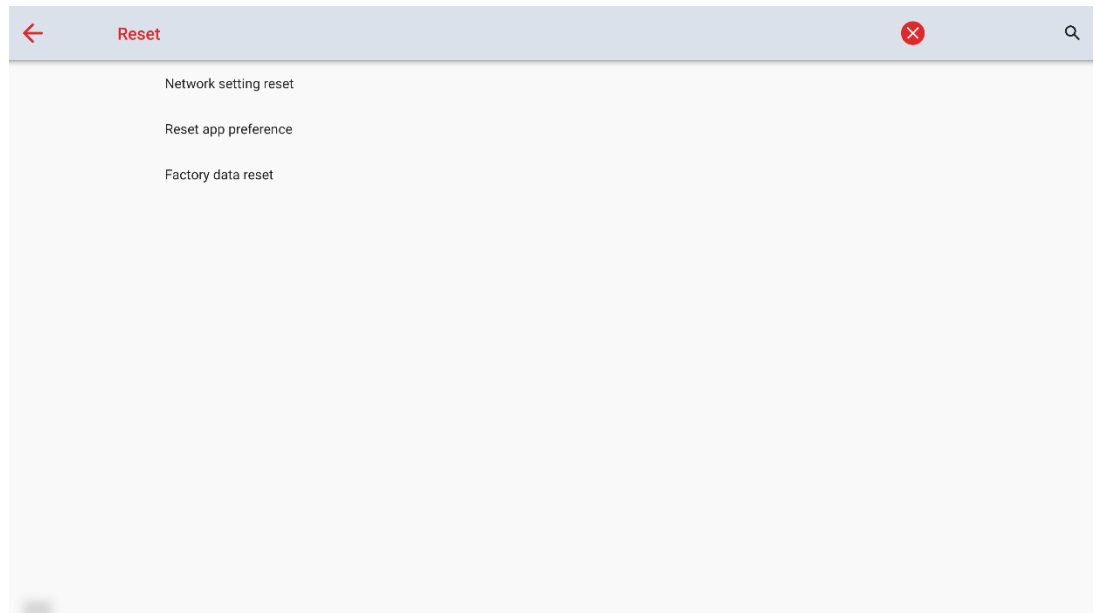

2. System update

Enter the **System update** submenu to set about Firmware update using USB method, Firmware config update using USB method and over the air update method.



3. Security

Enter the **Security** submenu to set about whiteboard and screenshot data removal frequency or USB lock.

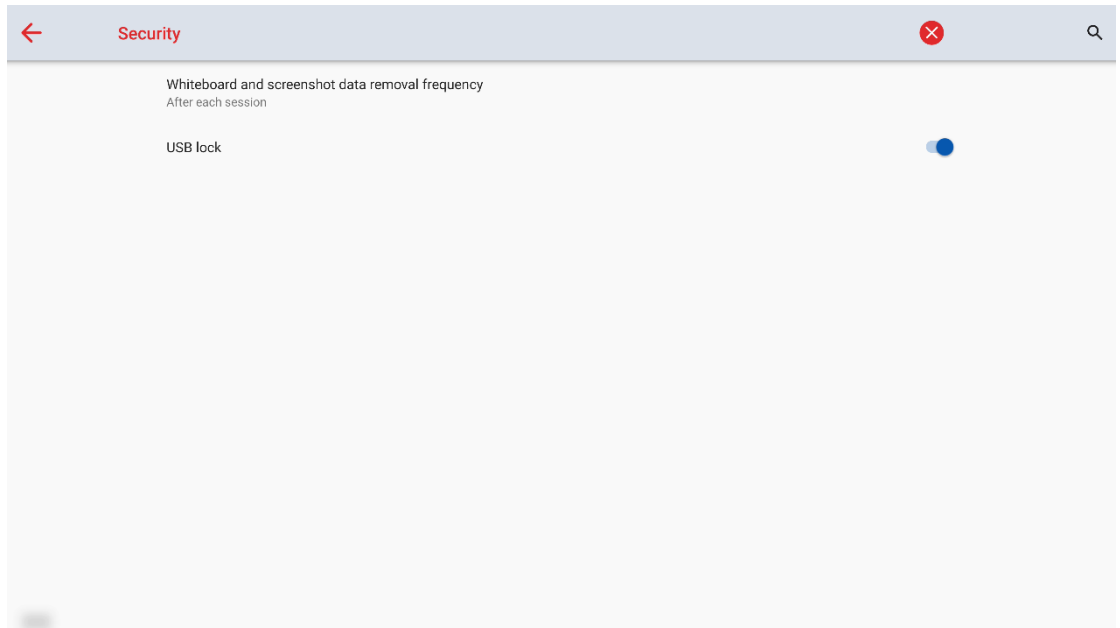

- Whiteboard and screenshot data removal frequency: You can set the data clearance time period, the default setting is never.

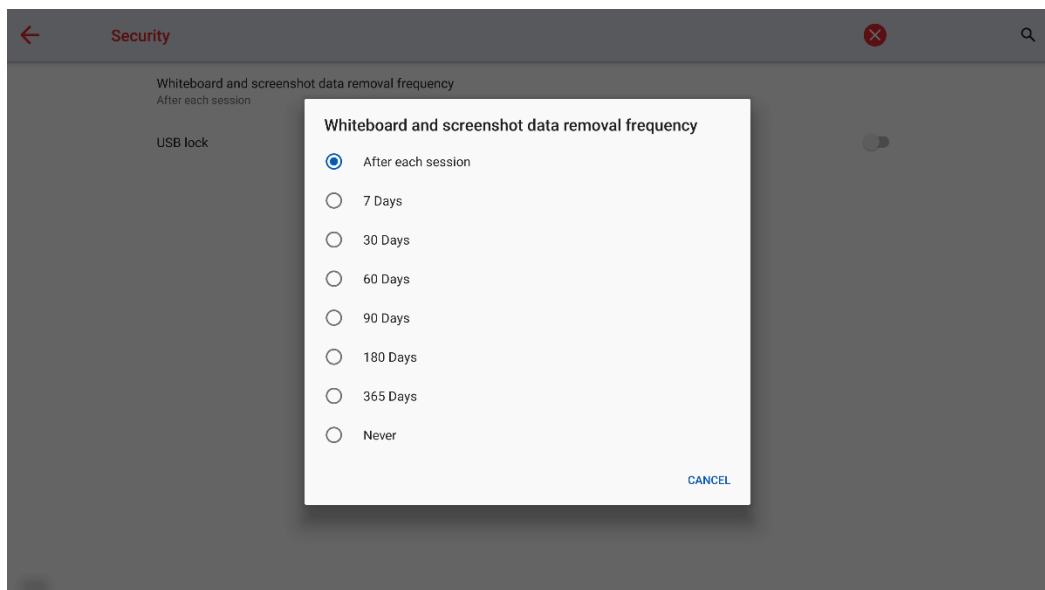

- USB lock: When you enable the USB lock, under the smart system, only USB disk will be locked, user will not able to read the data from the USB disk, but USB mouse and keyboard could be used. Under the external source, all the USB devices will be blocked.

4. Accounts

Enter the **Accounts** setting to check the owner accounts, rename owner or reset account passkey.



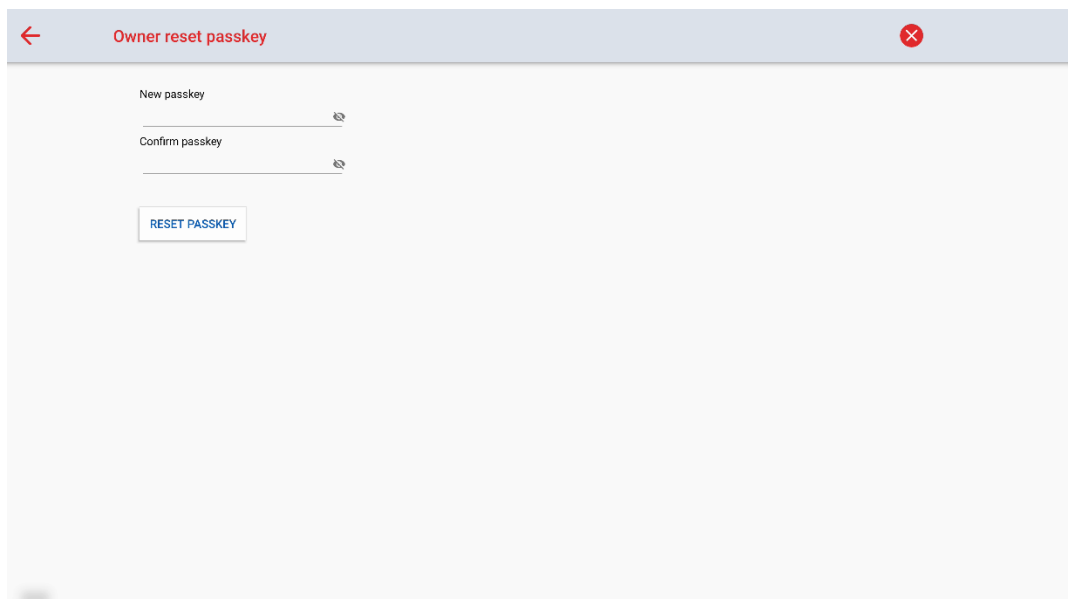

- Owner rename: If you would like to change owner name, you can rename it here.
- Reset passkey: If you would like to reset passkey, you can reset it here.















5 Quick Setting Menu

Using two fingers and swipe up from the bottom of the screen to access the Quick Settings menu, as shown in the following figure.



Icon	Functions
	Drag the slider to adjust the brightness.
	Drag the slider to adjust the volume.
	Tap the icon to enable the Freeze Function.

Icon	Functions
	Tap the icon to mute/unmute.
	Tap the icon to enable or disable the embedded operating system Wi-Fi.
	Tap the icon to launch the Newline Classroom Tools.
	Tap the icon to enable sound only mode. In sound only mode, the screen LCD displays and LED backlight turns off, other functions will continue to work as normal.
	Tap the icon to enable or disable the left toolbar.
	Tap the icon to return to Home page.
	Tap the icon to view the external signal sources.
	Tap the icon to enter the settings page.
	Tap the icon and choose an app to use in split screen.
	Tap the icon to enable the palm eraser function.
	Tap the icon to enable the palm rejection.
	Tap the icon to lock/unlock the screen.
	Tap the icon to log out of your profile.

6 Serial Port Control

RS232 communication cable (please use cross data cables)

PIN	This Device	Computer
1	NC	NC
2	RXD0	TXD0
3	TXD0	RXD0
4	NC	NC
5	GND	GND
6	NC	NC
7	NC	NC
8	NC	NC
9	NC	NC
Cover	GND	GND

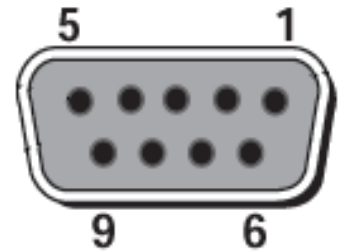

RS232 port of panel

Connect RS-232 port to the PC or controlling product. Enable RS-232 serial port connection and complete the following configuration.

Port: COM1 (Set according to PC or controlling product's port number)			
Baud rate	115200	Odd/even check	None
Data bits	8	Stop bit	1

The following tables list controlling codes, querying codes and return codes.

Function	Controlling codes	Return codes
Power on	7F 08 99 A2 B3 C4 02 FF 01 00 CF	7F 09 99 A2 B3 C4 02 FF 01 00 01 CF
Power off	7F 08 99 A2 B3 C4 02 FF 01 01 CF	7F 09 99 A2 B3 C4 02 FF 01 01 01 CF
Mute/Unmute	7F 08 99 A2 B3 C4 02 FF 01 02 CF	7F 09 99 A2 B3 C4 02 FF 01 02 01 CF
Signal source	7F 08 99 A2 B3 C4 02 FF 01 06 CF	7F 09 99 A2 B3 C4 02 FF 01 06 01 CF
Enable whiteboard	7F 08 99 A2 B3 C4 02 FF 01 07 CF	7F 09 99 A2 B3 C4 02 FF 01 07 01 CF
Display status	7F 08 99 A2 B3 C4 02 FF 01 09 CF	7F 09 99 A2 B3 C4 02 FF 01 09 01 CF
HDMI front / HDMI 1	7F 08 99 A2 B3 C4 02 FF 01 0A CF	7F 09 99 A2 B3 C4 02 FF 01 0A 01 CF
HDMI rear 1 / HDMI 2	7F 08 99 A2 B3 C4 02 FF 01 52 CF	7F 09 99 A2 B3 C4 02 FF 01 52 01 CF
HDMI rear 2 / HDMI 3	7F 08 99 A2 B3 C4 02 FF 01 53 CF	7F 09 99 A2 B3 C4 02 FF 01 53 01 CF
VGA / USB-C (Front)	7F 08 99 A2 B3 C4 02 FF 01 54 CF	7F 09 99 A2 B3 C4 02 FF 01 54 01 CF
USB-C (Rear)	7F 08 99 A2 B3 C4 02 FF 01 55 CF	7F 09 99 A2 B3 C4 02 FF 01 55 01 CF
Internal PC	7F 08 99 A2 B3 C4 02 FF 01 38 CF	7F 09 99 A2 B3 C4 02 FF 01 38 01 CF
Internal SDM	7F 08 99 A2 B3 C4 02 FF 01 39 CF	7F 09 99 A2 B3 C4 02 FF 01 39 01 CF
DP	7F 08 99 A2 B3 C4 02 FF 01 56 CF	7F 09 99 A2 B3 C4 02 FF 01 56 01 CF
Page up	7F 08 99 A2 B3 C4 02 FF 01 13 CF	7F 09 99 A2 B3 C4 02 FF 01 13 01 CF
Page down	7F 08 99 A2 B3 C4 02 FF 01 14 CF	7F 09 99 A2 B3 C4 02 FF 01 14 01 CF
VOL -	7F 08 99 A2 B3 C4 02 FF 01 17 CF	7F 09 99 A2 B3 C4 02 FF 01 17 01 CF
VOL +	7F 08 99 A2 B3 C4 02 FF 01 18 CF	7F 09 99 A2 B3 C4 02 FF 01 18 01 CF
Menu	7F 08 99 A2 B3 C4 02 FF 01 1B CF	7F 09 99 A2 B3 C4 02 FF 01 1B 01 CF

Home page	7F 08 99 A2 B3 C4 02 FF 01 1C CF	7F 09 99 A2 B3 C4 02 FF 01 1C 01 CF
Return (exit)	7F 08 99 A2 B3 C4 02 FF 01 1D CF	7F 09 99 A2 B3 C4 02 FF 01 1D 01 CF
OK	7F 08 99 A2 B3 C4 02 FF 01 2B CF	7F 09 99 A2 B3 C4 02 FF 01 2B 01 CF
←	7F 08 99 A2 B3 C4 02 FF 01 2C CF	7F 09 99 A2 B3 C4 02 FF 01 2C 01 CF
→	7F 08 99 A2 B3 C4 02 FF 01 2D CF	7F 09 99 A2 B3 C4 02 FF 01 2D 01 CF
↑	7F 08 99 A2 B3 C4 02 FF 01 2E CF	7F 09 99 A2 B3 C4 02 FF 01 2E 01 CF
↓	7F 08 99 A2 B3 C4 02 FF 01 2F CF	7F 09 99 A2 B3 C4 02 FF 01 2F 01 CF
Set volume	7F 08 99 A2 B3 C4 02 FF 05 XX CF	7F 09 99 A2 B3 C4 02 FF 05 XX 01 CF
Query the firmware version number	7F 08 99 A2 B3 C4 02 FF 01 3D CF	7F 09 99 A2 B3 C4 02 FF 01 3D XX CF
Set display mode	7F 08 99 A2 B3 C4 02 FF 06 XX CF	7F 09 99 A2 B3 C4 02 FF 06 XX 01 CF
Enable the annotation function	7F 08 99 A2 B3 C4 02 FF 01 40 CF	7F 09 99 A2 B3 C4 02 FF 01 40 01 CF
Increase backlight brightness	7F 08 99 A2 B3 C4 02 FF 01 47 CF	7F 09 99 A2 B3 C4 02 FF 01 47 01 CF
Decrease backlight brightness	7F 08 99 A2 B3 C4 02 FF 01 48 CF	7F 09 99 A2 B3 C4 02 FF 01 48 01 CF
Set the value of backlight brightness	7F 08 99 A2 B3 C4 02 FF 09 XX CF	7F 09 99 A2 B3 C4 02 FF 09 XX 01 CF
Switch backlight	7F 08 99 A2 B3 C4 02 FF 01 15 CF	7F 09 99 A2 B3 C4 02 FF 01 15 XX CF
Switch to screen lock	7F 08 99 A2 B3 C4 02 FF 01 57 CF	7F 09 99 A2 B3 C4 02 FF 01 57 01 CF
Screenshot	7F 08 99 A2 B3 C4 02 FF 01 1F CF	7F 09 99 A2 B3 C4 02 FF 01 1F 01 CF
Settings	7F 08 99 A2 B3 C4 02 FF 01 20 CF	7F 09 99 A2 B3 C4 02 FF 01 20 01 CF

Freeze ON/OFF toggle	7F 08 99 A2 B3 C4 02 FF 01 3B CF	7F 09 99 A2 B3 C4 02 FF 01 3B 01 CF
Freeze On	7F 09 99 A2 B3 C4 02 FF 0B 00 CF	7F 09 99 A2 B3 C4 02 FF 0B 00 01 CF
Freeze Off	7F 09 99 A2 B3 C4 02 FF 0B 01 CF	7F 09 99 A2 B3 C4 02 FF 0B 01 01 CF
Mute On	7F 09 99 A2 B3 C4 02 FF 0F 00 CF	7F 09 99 A2 B3 C4 02 FF 0F 00 01 CF
Mute Off	7F 09 99 A2 B3 C4 02 FF 0F 01 CF	7F 09 99 A2 B3 C4 02 FF 0F 01 01 CF
Switch Safety Lock On	7F 09 99 A2 B3 C4 02 FF 0D 01 CF	7F 09 99 A2 B3 C4 02 FF 0D 01 01 CF
Switch Safety Lock Off	7F 09 99 A2 B3 C4 02 FF 0D 00 CF	7F 09 99 A2 B3 C4 02 FF 0D 00 01 CF
Switch Backlight On	7F 09 99 A2 B3 C4 02 FF 0E 01 CF	7F 09 99 A2 B3 C4 02 FF 0E 01 01 CF
Switch Backlight Off	7F 09 99 A2 B3 C4 02 FF 0E 00 CF	7F 09 99 A2 B3 C4 02 FF 0E 00 01 CF
Set Display message on the OSD	7F 09 99 A2 B3 C4 02 FF 1A XX CF	7F 09 99 A2 B3 C4 02 FF 1A 00 XX CF

Function	Querying codes	Return codes
Power supply	7F 08 99 A2 B3 C4 02 FF 01 37 CF	7F 09 99 A2 B3 C4 02 FF 01 37 XX CF Notes: XX indicates the power on/off state. XX = 01: power on state; XX = 00: power off state.
Speaker	7F 08 99 A2 B3 C4 02 FF 01 82 CF	7F 09 99 A2 B3 C4 02 FF 01 82 XX CF Notes: 01: mute; 00: non-mute.
Current signal source	7F 08 99 A2 B3 C4 02 FF 01 50 CF	7F 09 99 A2 B3 C4 02 FF 01 50 XX CF Notes: Smart system = 30; PC = 17; DP = 20; HDMI rear 1 = 1F; HDMI Rear 2 = 1E; VGA = 00; HDMI Front = 19; Type C = 22.
Speaker volume	7F 08 99 A2 B3 C4 02 FF 01 33 CF	7F 09 99 A2 B3 C4 02 FF 01 33 XX CF Notes: XX indicates current volume value (XX is a hexadecimal value, range: 00~64). For example, XX = 20 indicates current volume value is 32 (decimal value), XX = 00 indicates mute state.

D.Mode	7F 08 99 A2 B3 C4 02 FF 01 35 CF	7F 09 99 A2 B3 C4 02 FF 01 35 XX CF Notes: XX indicates the mode. XX = 00-standard; XX = 01-ECO mode; XX = 02-auto.
Backlight brightness	7F 08 99 A2 B3 C4 02 FF 01 49 CF	7F 09 99 A2 B3 C4 02 FF 01 49 XX CF Notes: XX indicates the value of backlight brightness (0 - 100), corresponding to the hexadecimal number system (00 - 64).
Backlight status	7F 08 99 A2 B3 C4 02 FF 01 81 CF	7F 09 99 A2 B3 C4 02 FF 01 81 XX CF Notes: XX = 00 indicates the backlight is on. XX = 01 indicates the backlight is off.
Screen lock status	7F 08 99 A2 B3 C4 02 FF 01 84 CF	7F 09 99 A2 B3 C4 02 FF 01 84 XX CF Notes: XX = 01 indicates the child safety lock is on. XX = 00 indicates the child safety lock is off.
Whiteboard state	7F 08 99 A2 B3 C4 02 FF 01 83 CF	7F 09 99 A2 B3 C4 02 FF 01 83 XX CF Notes: XX = 01 indicates the whiteboard state. XX = 00 indicates non-whiteboard state.
Return to system state of the previous options	7F 08 99 A2 B3 C4 02 FF 0A 00 CF	7F 08 99 A2 B3 C4 02 FF 0A 00 AB CD EF GH IJ OP QR ST UV CF Notes: AB: Power supply; CD: Speaker; EF: Current signal source; GH: Speaker volume; IJ: D.Mode;

		OP: backlight brightness; QR: backlight state; ST: Whiteboard state; UV: Screen lock state.
--	--	--

7 FAQs & Troubleshooting

Symptom	Troubleshooting Methods
The screen cannot be powered on or the power indicator light is off.	Check whether the power supply is connected.
	Check whether the power supply plug is properly connected.
	Check whether the power outlet has electricity.
	Check whether the rocker switch is enabled.
	Press the reset switch and start the system again.
The remote control is not causing a response.	Replace the batteries.
	Check whether the polarity direction of the batteries is correct.
	Align the remote control with the IR receiver window. For details, see section "Remote Control".
The image is normal but there is no sound.	Increase volume on both the screen and the Windows system.
	Check whether the screen and the Windows system are muted.
	If an external computer is connected, check whether the connection cables are normal.
The system is automatically powered on/off when no operation is being performed.	Disable the automatic power-on/off function. For details, see section "Power ON/OFF Setting".
	Check whether the screen entered shut down mode due to no operation for an extended period of time.
	Check whether the input power supply is stable.
The colors of images are abnormal.	Check whether the HDMI cable is properly connected or has any quality issue.
The touch function is abnormal or the positioning is inaccurate.	Restart the screen.
	In the Windows system, recalibrate the screen. For details, see section "Calibration".
The touch function is unavailable when	Switch between different external signal sources.

Symptom	Troubleshooting Methods
the external signal source channel is being used.	Ensure that the USB touch cable is connected to the proper port. For details, see section "Ports".
	Remove and insert the USB touch cable again.
There is no sound when the HDMI in channel is used.	Remove and insert the HDMI cable again.
No image is displayed when the HDMI out channel is used.	Generally, this issue is caused by the compatibility of the external display product. Replace the external display product and test again.
	The HDMI cable is too long or has a poor quality. Replace the HDMI cable delivered with the product.
The touch function on the front panel is ineffective.	Touch the button using your full fingertip.
	Check whether the finger is wet or has other liquids on it.
	Restart the screen.
The USB flash drive cannot be identified.	Check whether the USB flash drive is inserted into the correct USB port. For details, see section "Ports."
The conference records cannot be saved on the USB flash drive, and the system prompts "The target storage product has no write permissions."	Format the USB flash drive to the FAT32 format.
The OPS has no signal.	Check whether the OPS is properly inserted in the slot.
	Check whether the OPS is in shut down mode.
	Press the power button on the OPS (for details, see the instructions of the OPS), and manually start up the OPS.
In the embedded operating system or Windows system, no wireless network can be found or the wireless network signal is weak.	Check whether the Wi-Fi antenna is properly installed on the embedded operating system. For details, see section "Ports".
	Check whether the Wi-Fi antenna is properly installed for the OPS.
The keyboard is not correctly displayed.	Confirm that the hardware keyboard is enabled.
When you connect a handheld microphone to a port on the front panel, the distance from user to microphone should be no less than 1 meter, otherwise the sound may distort.	The front panel doesn't support handheld microphone, and needs to use the fixed microphone. To make sure of the sound quality, the distance from user to microphone should be no less than one meter.

Symptom	Troubleshooting Methods
When the touch screen connects to CEC facilities and powers down, touch screen will stay in shut down mode after power restart. CEC facilities can't recall the touch screen.	Please use the remote control to start and turn off the touch screen. Then you can use the CEC facilities to recall it.

8 Specifications

Model	TT-6521Q	TT-7521Q	TT-8621Q
Display			
Backlight	LED		
Display Area	56.24 x 31.63 in/ 1432 x 807mm	64.97 in x 36.55 in/ 1652 x 930mm	74.69 in x 42.05 in/ 1893 x 1069mm
Active Screen Size	65 inch	75 inch	86 inch
Display Ratio	16:9		
Resolution	3840 x 2160 Pixel		
Display Colors	8 bit+FRC, 1.07 billion colors	8 bit+FRC, 1.07 billion colors	10 bit, 1.07 billion colors
Brightness	$\geq 400 \text{ cd/m}^2$		
Contrast	$\geq 5000:1$	$\geq 5000:1$	$\geq 5000:1$
Response Time	$\leq 8 \text{ ms}$		
Life Time	$\geq 50000 \text{ h (Min.)}$		
Speaker			
Speaker Position	Forward		
Max. Power Output	2 x 15 W		
Microphone			
Type	3.5 mm interface		
Electrical			
Power Consumption	Maximum $\leq 400 \text{ W}$ Standby Mode $\leq 0.5 \text{ W}$	Maximum $\leq 450 \text{ W}$ Standby Mode $\leq 0.5 \text{ W}$	Maximum $\leq 500 \text{ W}$ Standby Mode $\leq 0.5 \text{ W}$
Working Voltage	AC 100 V – 240 V, 50 Hz / 60 Hz		

Model	TT-6521Q	TT-7521Q	TT-8621Q
Touch			
Touch Surface	Anti-glare tempered glass		
Transparency	88%±3%		
Touch Points	10 Points in Smart system 20 Points in Windows		
Writing Tools	Eraser, Stylus or Finger		
Scan Speed	≤10ms	≤10ms	≤10ms
Communication Interface	USB-A		
Transportation/Storage			
Storage Temperature/ Humidity	-15°C~55°C/20~90%RH(Non coagulation)		
Working Temperature/ Humidity	0°C-40°C/20~80%RH(Non coagulation)		
Mounting (optional)	Wall-mounted/Floor Stand		
Outline Dimension	1513x923x116mm	1735x1049x120mm	1981x1189x120mm
Packing Dimension	1640*1036*207 mm	1859x1160x227 mm	2119x1290x250 mm
Net Weight	approx. 39kg	approx. 52kg	approx. 65kg
Gross Weight	50±2kg	66±2kg	82±2kg
Ports			
Front Interface Inputs	HDMI In x 1, USB (Touch) x 1, USB 3.0 x 1, Microphone In x 1, Type C x 1		
Rear Interface Inputs	RS-232 x 1, Line Out x 1, SPDIF out x 1, HDMI Out x 1, USB 3.0 (Public) x 2, USB 3.0 (Android) x 1, Type C x 1, USB3.0 (Touch) x 3, HDMI 2/3 In x 2, DP x 1, OPS Slots (4K@60Hz)		
Other functions			
Intelligent thermos protector	Yes		
Smart System			
Chips	A311D2		
RAM	Standard with 4G(can be expanded to 8G)		

Model	TT-6521Q	TT-7521Q	TT-8621Q
Flash	32GB build in + 64GB TF card		
Multimedia File Formats	Supports all major types of multi-media files		
Pre-installed applications	Refer to the actual panel display.		

9 More Information

For More Information

Please visit our website (www.newline-interactive.com) for detailed instruction manual.

Contact Us for Support

Please email us at support@newline-interactive.com.

Our company is devoted to product innovation and technology enhancement. Therefore, we may change product specification and information without notice. Product pictures in the manual are for reference only, please refer to actual products.