

Please read this manual carefully before installation and keep it for future reference.

AHU Remote Control User Manual



MRCOOL®

COMFORT MADE SIMPLE

Due to updates and constantly improving performance, the information and instructions within this manual are subject to change without notice. Please visit www.mrcool.com/documentation to ensure you have the latest version of this manual.

Version Date: 02-21-22

For more info visit www.mrcool.com

1	Remote Controller Specifications & Quick Start Guide	2
2	Handling the Remote Controller	3
3	AHU Remote Controller	4
	Buttons & Functions	4
	Remote Screen Indicators	5
	How to Use Basic Functions	6
	Setting the Timer	8
	How to Use Advanced Functions	9

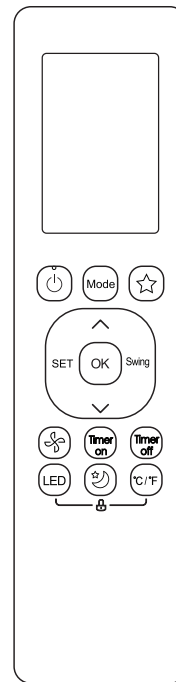

**AHU Remote Controller
Model #: RG10F2(D2)/BGEFU1**

Model	AHU: RG10F2(D2)/BGEFU1
Rated Voltage	3.0V (Dry Batteries R03/LR03 x 2)
Signal Receiving Range	26.25 ft. (8m)
Operational Temperature Range	23°F ~ 140°F (-5°C ~ 60°C)

Quick Start Guide

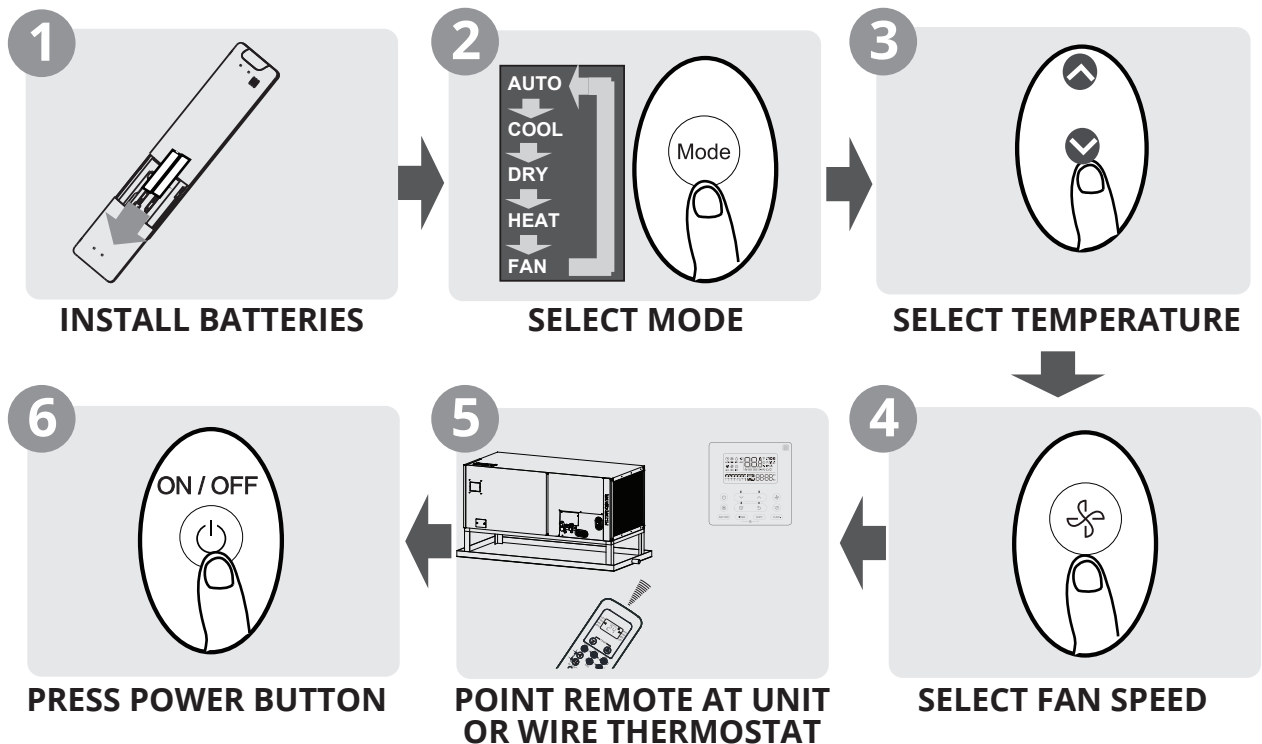

NOT SURE WHAT A FUNCTION DOES?

Refer to the **How to Use Basic Functions** and **How to Use Advanced Functions** sections of this manual for more detailed instructions of how to operate the unit.

SPECIAL NOTE

- Button designs on your remote may differ slightly from the example shown.
- If the indoor unit is not equipped with a particular function, but your remote controller has a button for it, pressing that function's button on the remote control will have no effect.
 - When there are differences between the "**Remote Controller Manual**" and the "**USER'S MANUAL**" when it comes to function description, the description of "**USER'S MANUAL**" should take precedence.

Inserting and Replacing Batteries

Your air conditioning unit may come with two batteries (some units). Install the batteries in the remote control before use by following the steps below:

1. Slide the back cover from the remote control downward to expose the battery compartment.
2. Insert the batteries, making sure to match the (+) and (-) designations on the end of the batteries with the symbols inside the battery compartment.
3. Reinstall the back cover by sliding it back into place.

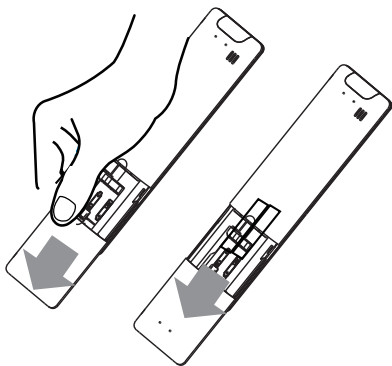

! BATTERY NOTES

For optimum product performance:

- Do not mix old with new batteries or with batteries of different types.
- Do not leave batteries in the remote control if the device will not be used for more than 2 months.



BATTERY DISPOSAL

- ⊘ **DO NOT** dispose of batteries as unsorted municipal waste. Refer to local laws for proper disposal of batteries.

TIPS FOR USING REMOTE CONTROL

- The remote control must be used within 26 ft (8 m) of the unit.
- The unit will beep when remote signal is received.
- Curtains, other materials, and direct sunlight can interfere with the infrared signal receiver. Remove batteries if the remote will not be used more than 2 months.

NOTES FOR USING REMOTE CONTROL

The device should comply with the local national regulations.

- In Canada, it should comply with CAN ICES-3(B)/NMB-3(B).
- In the USA, this device complies with part 15 of the FCC Rules. Operation is subject to the following two conditions:
 - (1) This device may not cause harmful interference, and
 - (2) this device must accept any interference received, including interference that may cause undesired operation.

This equipment has been tested and found to comply with the limits for a Class B digital device, pursuant to part 15 of the FCC Rules. These limits are designed to provide reasonable protection against harmful interference in a residential installation. This equipment generates, uses, and radiates radio frequency energy. If it is not installed and used in accordance with the instructions, it may cause harmful interference to radio communications. However, there is no guarantee that interference will not occur in a particular installation. If this equipment does cause harmful interference to radio or television reception, which can be determined by turning the equipment off and on, the user is encouraged to try to correct the interference by using one or more of the following measures:

- Reorient or relocate the receiving antenna.
- Increase the separation between the equipment and receiver.
- Connect the equipment into an outlet on a circuit different from that to which the receiver is connected.
- Consult the dealer or an experienced radio/TV technician for help.
- Changes or modifications not approved by the party responsible for compliance could void user's authority to operate the equipment.

Buttons and Functions

Before you begin using your new air conditioner, make sure to familiarize yourself with its remote control. The following is a brief introduction to the remote control itself. For instructions on how to operate your air conditioner, refer to the **How to Use Basic Functions** section of this manual.

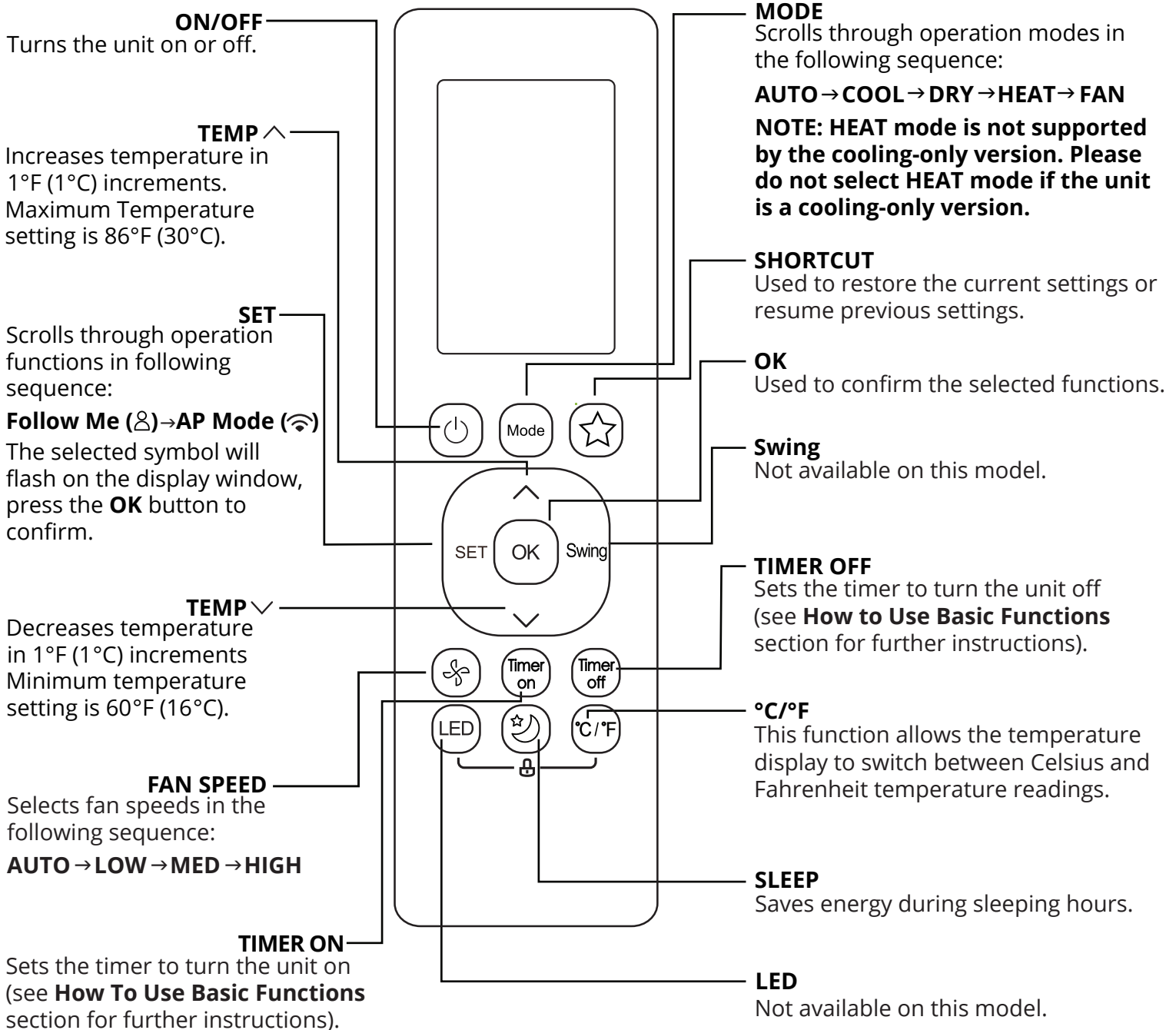

NOTE: Some of the buttons on the remote controller may have labels for features that are not available on the unit it is being used on. However, these buttons may be used to activate other features. Please refer to the How to Use Basic Functions and How to Use Advanced Functions sections of this manual for more information.

Remote Screen Indicators

Information that is displayed when the remote controller is turned on.

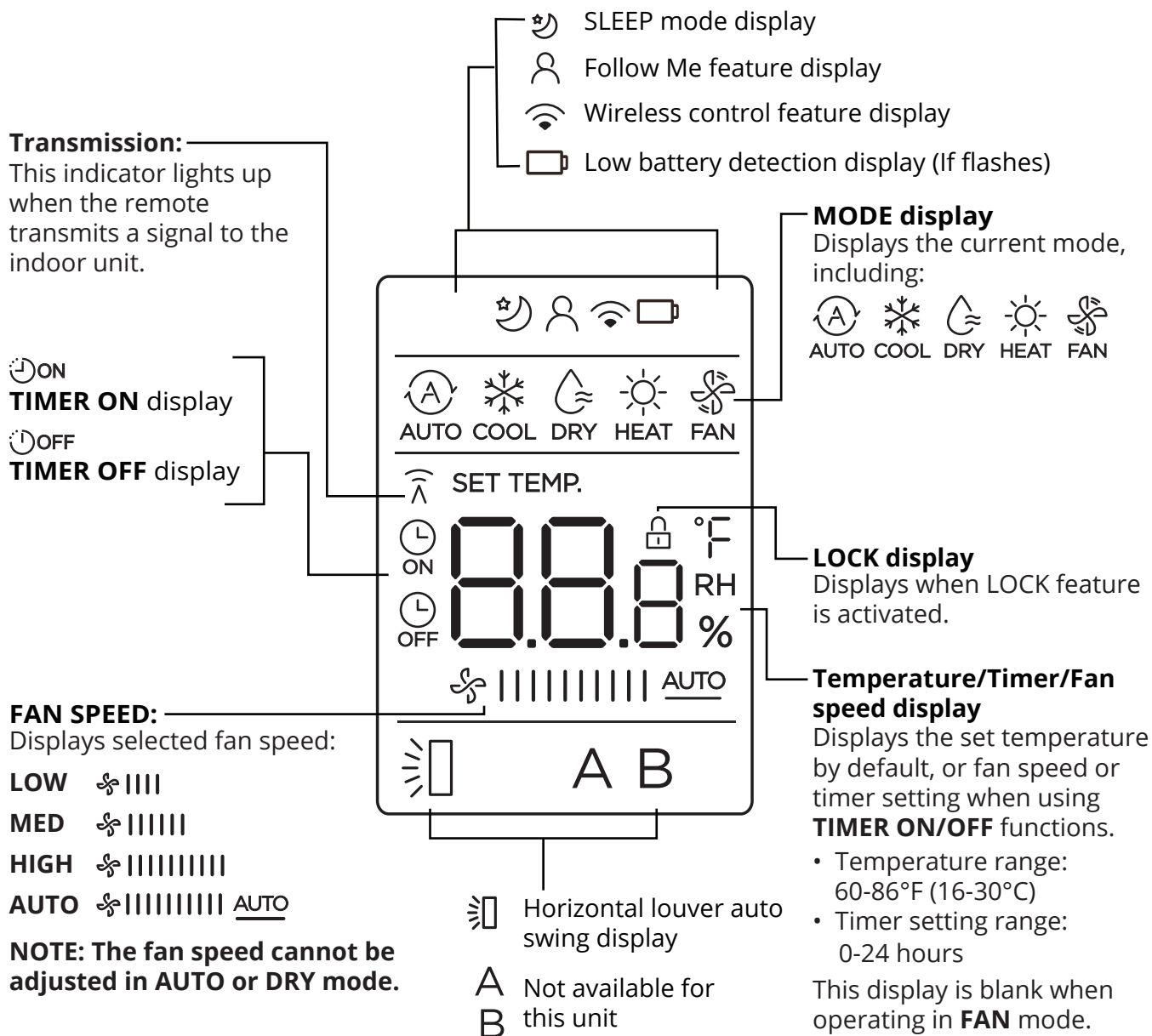

NOTE: All indicators shown are for demonstration purposes. During actual operation, only the relative and active functions will be shown in the display window.

How to Use Basic Functions

! ATTENTION

Please ensure the unit has power before operation is attempted.

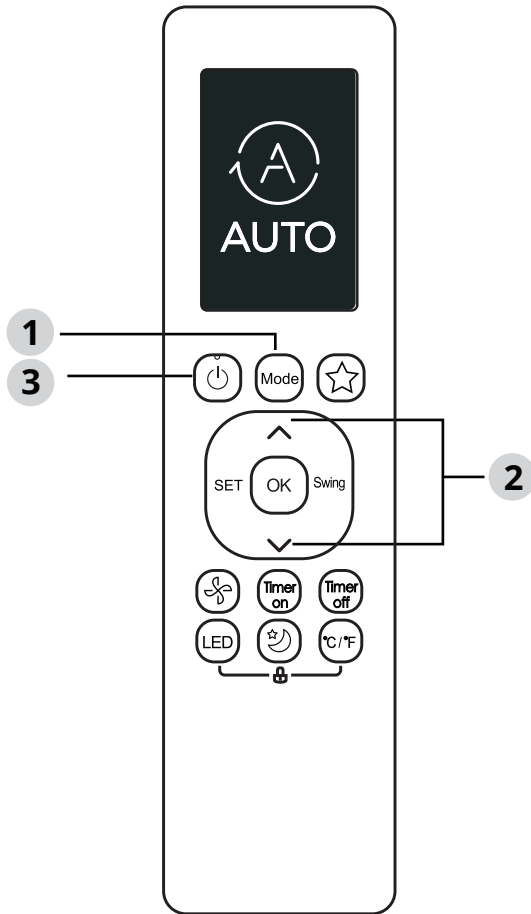

SETTING TEMPERATURE

The operating temperature range for units is 60-86°F (16-30°C) or 68-82°F (20-28°C) (model dependent). You can increase or decrease the set temperature in 1°F (1°C) increments by using the the Temperature ^ or v buttons on the remote.

AUTO Mode

In **AUTO** mode, the unit will automatically select the **COOL, FAN, or HEAT** operating mode based on the set temperature. To select AUTO mode follow these steps:

1. Press the **MODE** button and select **AUTO** mode.
2. Set your desired temperature using the **TEMPERATURE** ^ or v buttons.
3. Press the **ON/OFF** button to start the unit.

NOTE: FAN speed cannot be set or adjusted in AUTO mode.

COOL Mode

To select **COOL** Mode follow these steps:

1. Press the **MODE** button and select **COOL** mode.
2. Set your desired temperature using the **TEMPERATURE** ^ or v buttons.
3. Press the **FAN** button to select the desired fan speed: **AUTO, LOW, MED, or HIGH.**
4. Press the **ON/OFF** button to start the unit.

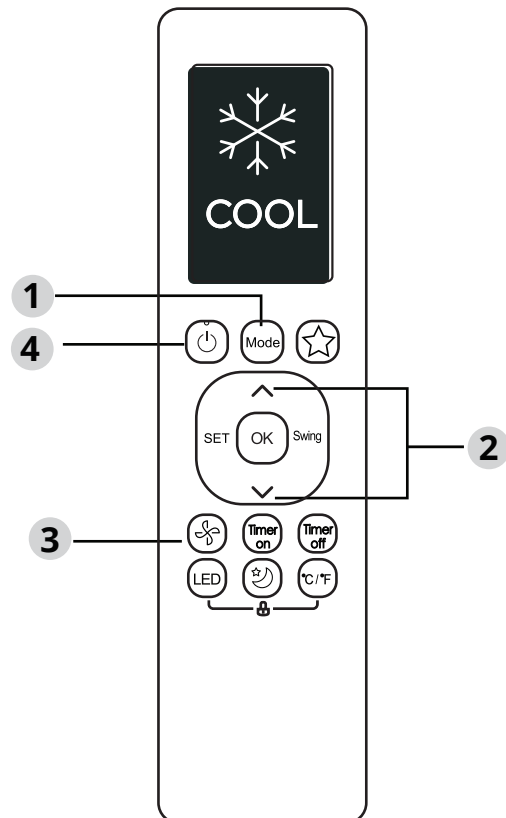

How To Use Basic Functions

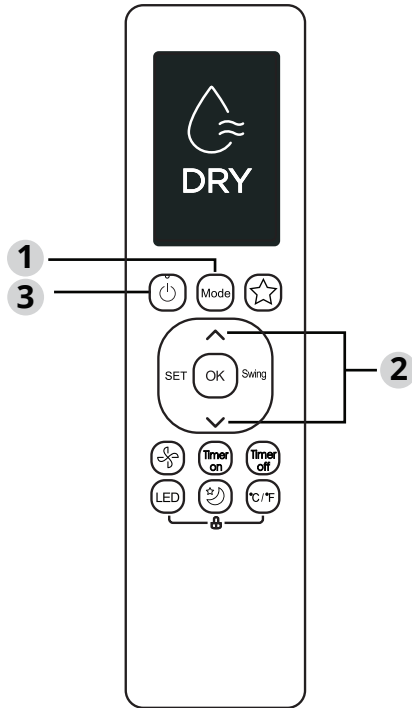

DRY Mode (dehumidifying function)

In **DRY** mode, the unit acts as a dehumidifier. To select **DRY** mode follow these steps:

1. Press the **MODE** button and select **DRY** mode.
2. Set your desired temperature using the **TEMPERATURE** \wedge or \vee buttons.
3. Press the **ON/OFF** button to start the unit.

NOTE: FAN speed cannot be set or adjusted in DRY mode.

FAN Mode

1. Press the **MODE** button and select **FAN** mode.
2. Press **FAN** button to select the desired the fan speed: **AUTO, LOW, MED, or HIGH**.
3. Press the **ON/OFF** button to start the unit.

NOTE: The temperature cannot be set or adjusted in FAN mode. As a result of this, the remote control LCD display will not display the temperature.

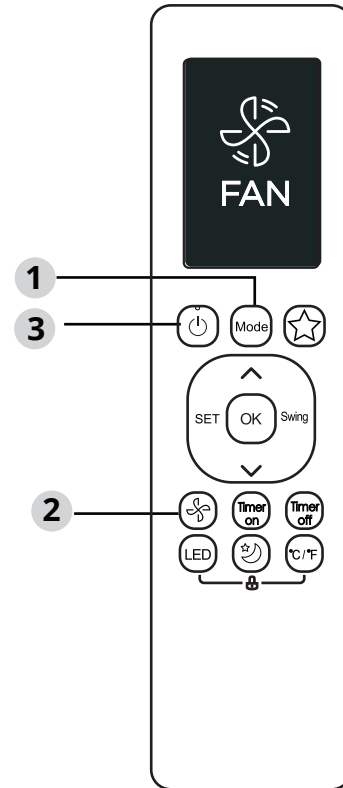

HEAT Mode

To select **HEAT** mode follow these steps:

1. Press the **MODE** button and select **HEAT** mode.
2. Set your desired temperature using the **TEMPERATURE** \vee or \wedge buttons.
3. Press the **FAN** button to select the desired fan speed: **AUTO, LOW, MED, or HIGH**.
4. Press the **ON/OFF** button to start the unit.

NOTE: As the outdoor temperature drops, the performance of the unit's HEAT function may be affected. If this occurs, we recommend using other heating appliances in conjunction with the unit.

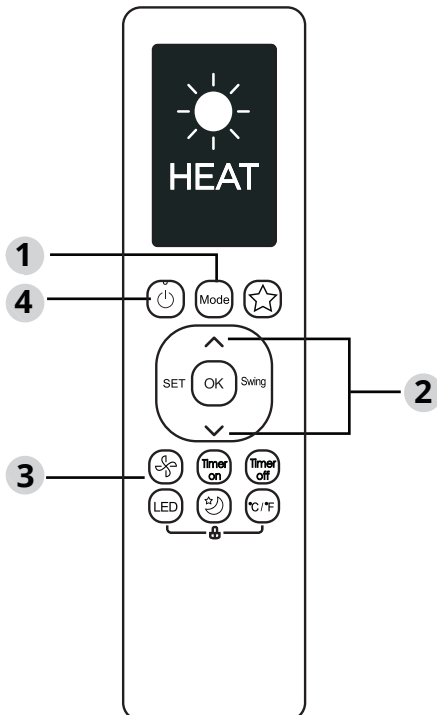

Setting the TIMER

TIMER ON/OFF - Set the amount of time after which the unit will automatically turn on/off.

TIMER ON setting

Press **TIMER** button to initiate the **ON** time sequence.



Press **Temperature UP or DOWN** button to set the desired time to turn **ON** the unit.

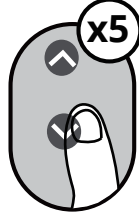

Point remote control at the unit or thermostat and wait 1 second, the **TIMER ON** will be activated.

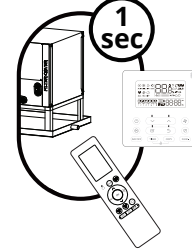

TIMER OFF setting

Press **TIMER** button to initiate the **OFF** time sequence.



Press **Temperature UP or DOWN** button to set the desired time to turn **OFF** the unit.

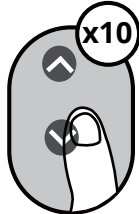

Point remote control at the unit or thermostat and wait 1 sec, the **TIMER OFF** will be activated.



NOTE:

- When setting the **TIMER ON** or **TIMER OFF**, the time will increase by 30 minutes increments with each press, up to 10 hours. After 10 hours and up to 24, it will increase in 1 hour increments. (For example, press 5 times to get 2.5h, and press 10 times to get 5h,) The timer will revert to 0.0 after 24.
- Cancel either function by setting its timer to 0.0h.

TIMER ON & OFF setting (example)

NOTE: Keep in mind that the time periods you set for both functions refer to hours after the current time.

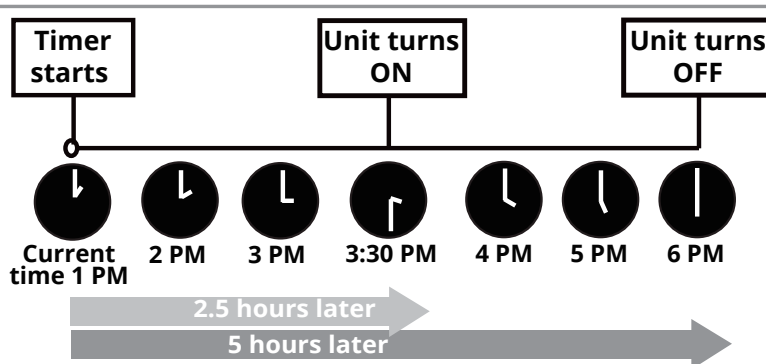
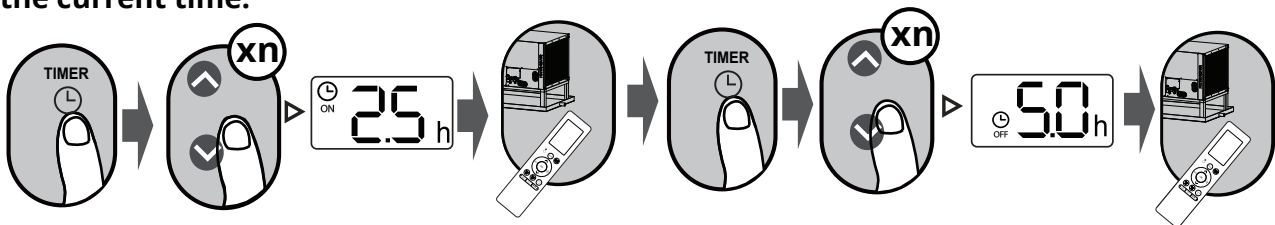

Example: If current time is 1:00PM, and the timer is set using the above steps, the unit will turn on 2.5 hours later (3:30PM) and then turn off at 6:00PM (5 hours after the timer is originally set).

How to Use Advanced Functions

SHORTCUT function

Press the **SHORTCUT** button (some units) to revert to previous settings:

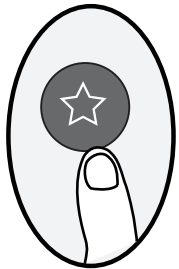

Pressing the **SHORTCUT** button when the remote controller is on will cause the system to automatically revert back to the previous settings including the operating mode, set temperature, fan speed level, and the sleep feature (if activated).

If the **SHORTCUT** button is pressed for more than 2 seconds, the system will automatically restore the current operation settings including the operating mode, set temperature, fan speed level and sleep feature (if activated).

°C/°F (some models)

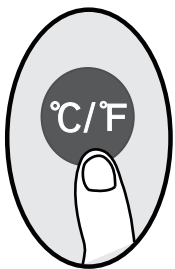

Press the **°C/°F** button (some units) to alternate the temperature display between Celsius and Fahrenheit.

LOCK function

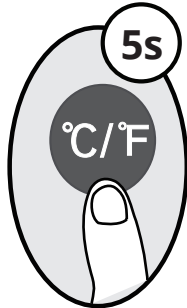
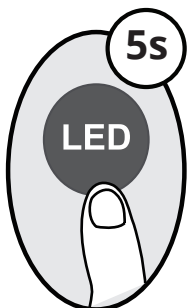

or

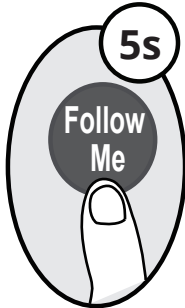

Press **LED** button and **°C/°F** button (Follow Me button on some models) at the same time for 5 seconds or more to activate the **LOCK** function. None of the buttons will respond when this function is activated. Pressing the buttons together again for a duration of two seconds will disable the **LOCK** function.

SLEEP function

Press the **SLEEP** button to activate the sleep function:

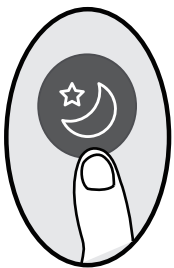

The **SLEEP** function is used to decrease the energy of the unit while you sleep. (The same temperature settings are not needed to stay comfortable while sleeping.) This function can only be activated by the remote control.

For further details on the **SLEEP** function please refer to the User's Manual.

NOTE: The SLEEP function is not available in FAN or DRY mode.

SET function

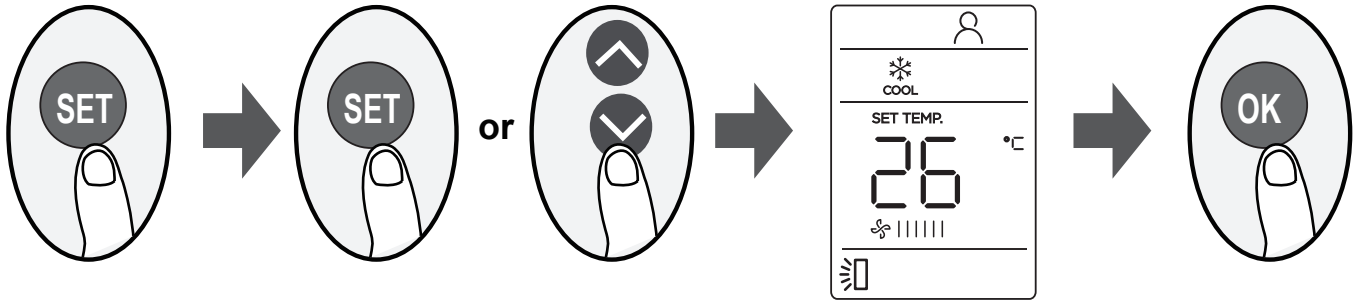

- Press the **SET** button to enter the function setting, then press the **SET** button or the **TEMP** \downarrow or \uparrow buttons to select the desired function. The selected symbol will flash on the display, press the **OK** button to confirm and this will activate the selected function.
- To cancel the selected function, just perform the same procedures as above.
- Press the **SET** button to scroll through operation functions as follows:

Follow Me* (人)

[*]: If your remote controller has a Follow Me button, you cannot use the SET button to select the Follow Me feature.

Follow Me function (人):

The **Follow Me** function enables the remote control to measure the temperature at the location it currently is and send this signal to the air conditioning unit in a 3 minute interval. When using **AUTO, COOL, or, HEAT** modes, measuring the ambient temperature from the remote control (instead of from the indoor unit itself) will enable the air conditioner to optimize the temperature where you currently are and ensure maximum comfort.

NOTE:

The air handler may be equipped with AP mode, which allows the unit to use the wireless network configuration. However, the air handler does not respond to the AP mode signal from the remote controller. The wired thermostat must be used to activate this feature if so equipped.



MRCOOL®

COMFORT MADE SIMPLE

Due to updates and constantly improving performance, the information and instructions within this manual are subject to change without notice. Please visit www.mrcool.com/documentation to ensure you have the latest version of this manual.

Version Date: 12-22-21