

medicair[®]

pro max



MANUAL - WAAMSSFL6

Healthy Air Anywhere

Combining innovative technology with outstanding design, we bring you a sophisticated air purification system to enhance levels of protection, performance and reassurance.

Our state of the art MedicAir® system eliminates the invisible contaminants in a room and disperses clean air filtered for viruses, bacteria and particulates. With its UVC technology and five stage filtration process, it's quick, efficient and quiet. Designed and developed for quality and longevity with widely trusted technology.



Read the maintenance instructions before opening the appliance or replacing UV-C emitter.



Appliances that are obviously damaged must not be operated.

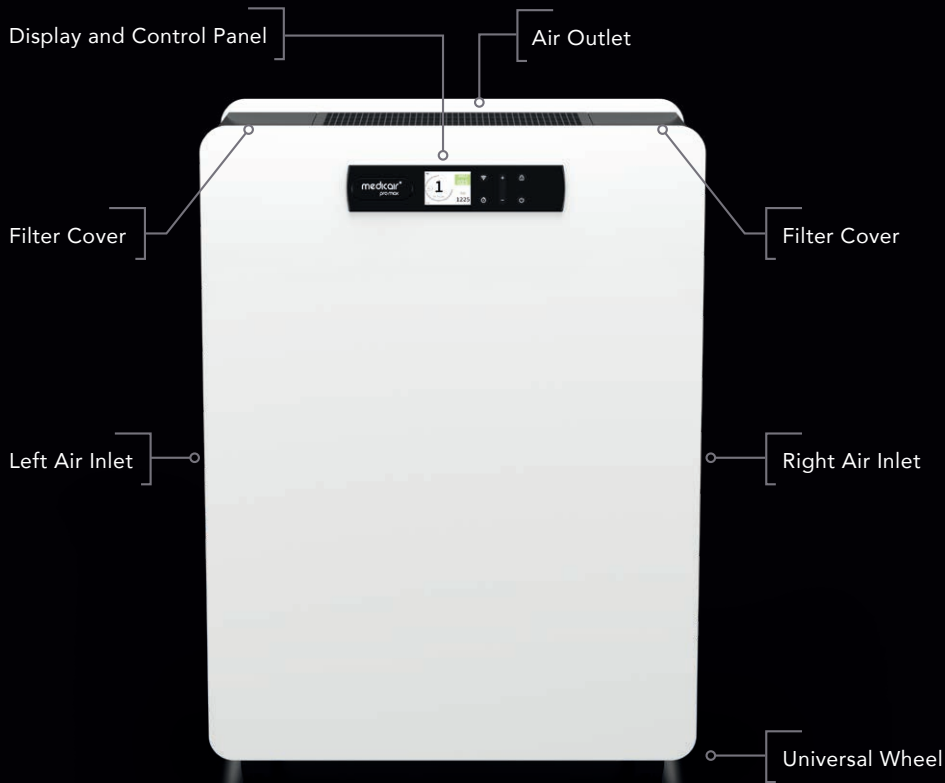

What's Included

- » 1 x MedicAir® unit
- » 1 x Power cord
(Country specific)
- » 1 x Combined Filter:
 - » Nano Hybrid
 - » Activated Carbon
 - » HEPA 14
 - » TiO₂ Reaction Chamber

① ②

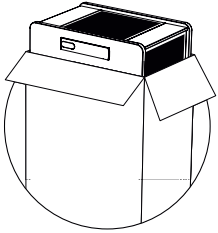

③

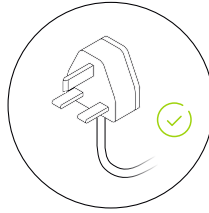
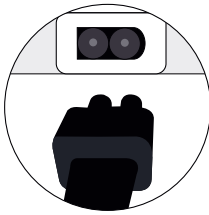

④

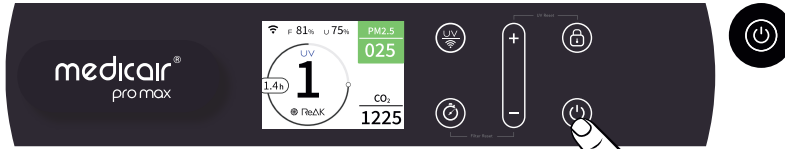



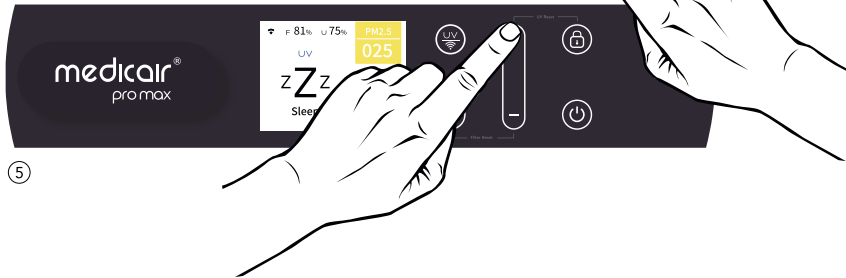

⑤



Getting Started

⚠ Do not lift MedicAir® out of the box by the top vents.

- ① Remove the protective foam lid out of the box, along with the power cord.
- ② Remove the unit from the box.
- ③ Connect the power cord on the bottom of the unit.
- ④ Press the power  button to turn the unit on. Wait for the LED screen to scan the air quality within its surrounds and complete its boot-up process, at which stage the screen will stop flashing. At this point you can choose your wind speed (via the Wind Speed  and  Buttons).
- ⑤ By pressing on the  or  button and toggle through to activate sleep mode. The sleep mode icon will be displayed.

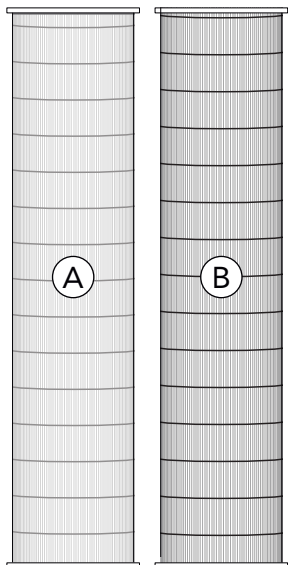

Filters

Ⓐ Pre-filter and ATP-HEPA filter cartridge

Ⓑ High-efficiency activated Carbon filter

A. Pre-filter and ATP-HEPA H14 antimicrobial peptide filter

This consists of an omni directional antimicrobial fibre mesh fabric capable of capturing and filtering large particles such as dust, hairs and skin flakes.

This prolongs the lifespan of the HEPA filter and improves system efficiency.

The high-density ATP-HEPA H14 antimicrobial peptide filter removes the majority of airborne particulate matter with a mean aerodynamic diameter of 2.5 μm .

B. High-efficiency activated carbon layer



This is a large honeycomb-structured filter which works to remove harmful substances such as mercury and benzene. It can subsequently reduce odours in the room.

Please visit the medicair.co.uk to buy high-performance combined filters.

Changing The MedicAir® Filter Cartridge

⚠ Prepare for the changing the filter cartridge by wearing gloves and dispose of the old filter in line with local recommendations.

⚠ UV radiation can be harmful to the eyes and skin. Do not operate UVC-emitter outside the appliance.

- 1 Turn off the power on the unit and disconnect from the power supply.
- 2 Lift filter cover and slide out existing filter.
- 3 Insert new filter cartridge.
- 4 Reconnect the power supply and power on the machine.
- 5 Press and hold the timer button  and  button together for 5 seconds to recalibrate the unit with the new filters.
- 6 Your device is now ready to use

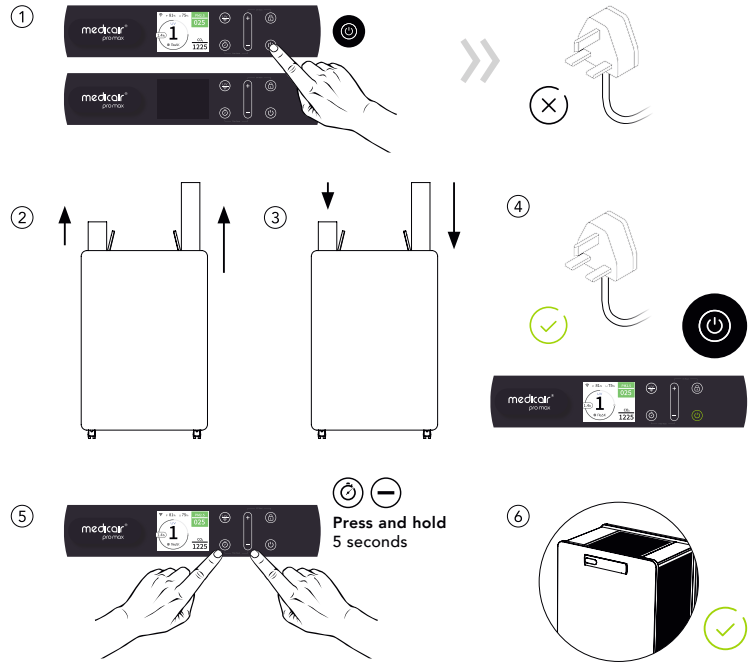





Changing UVC Lamp

 When the remaining time of the UV lamp is 0, please replace the UV lamp in time to avoid affecting the disinfection performance of the machine.

 Note: When replacing the UV lamp, please stop the machine and disconnect the power.

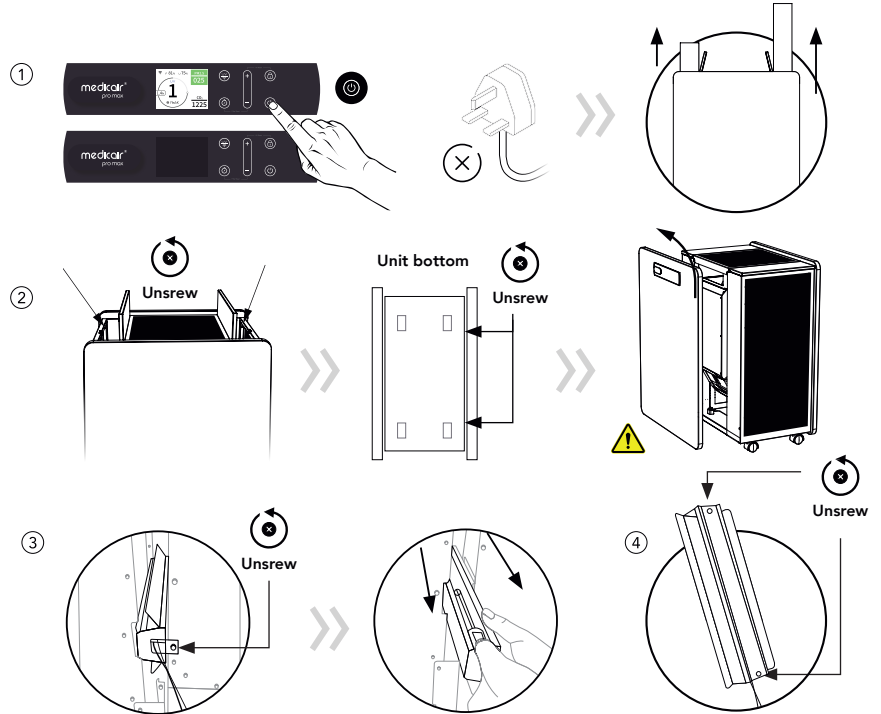
- 1 Disconnect the power supply, take out the filters on both sides.
- 2 Unscrew the two screws on the top, and remove the front door panel. When removing the front panel, please unplug the display panel cable first.
- 3 Unscrew the lamp fastener from unit shown in the diagram and slowly slide lamp casing out.
- 4 To access the lamp, remove the two screw indicated in the diagram and slowly rotate plate over.



- ⑤ Remove the bulb by pulling up and insert new bulb. Flip round and re-secure to base plate.
- ⑥ Slide/fasten the lamp back into unit.
- ⑦ Before securing the panel please reconnect the display panel cable.
- ⑧ Screw panel back on and add the filters back in on both sides. Reconnect the power supply and switch on.
- ⑨ Press and hold the child lock button  and the  button for 5s, reset the UV lamp replacement time and cancel the UV lamp replacement prompt.

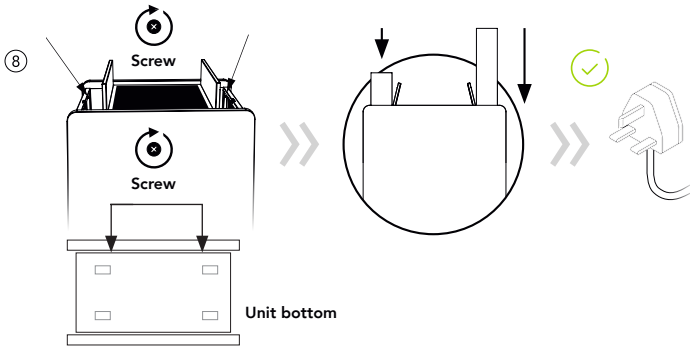
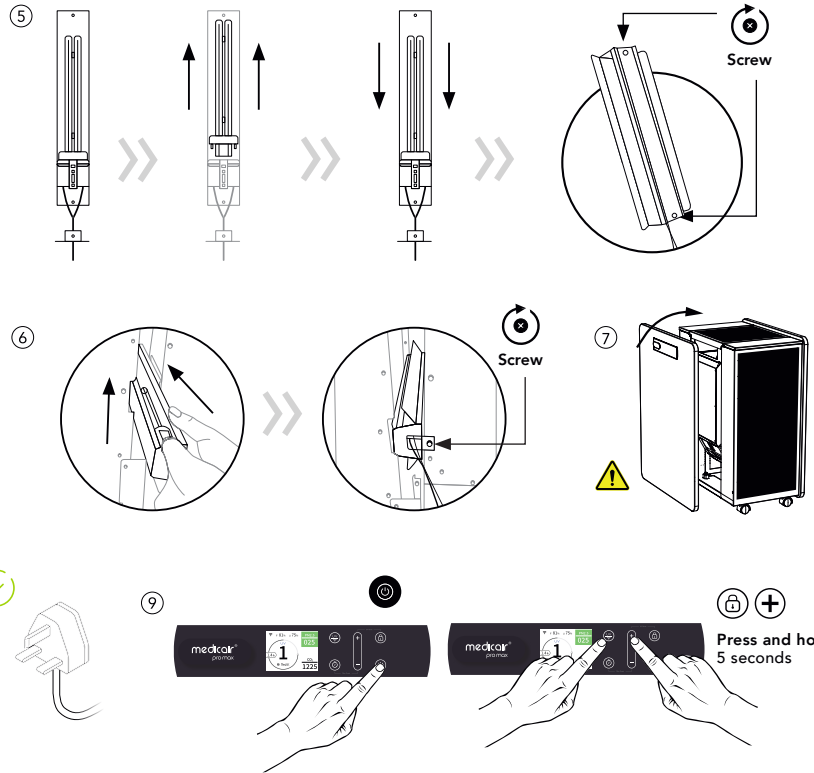

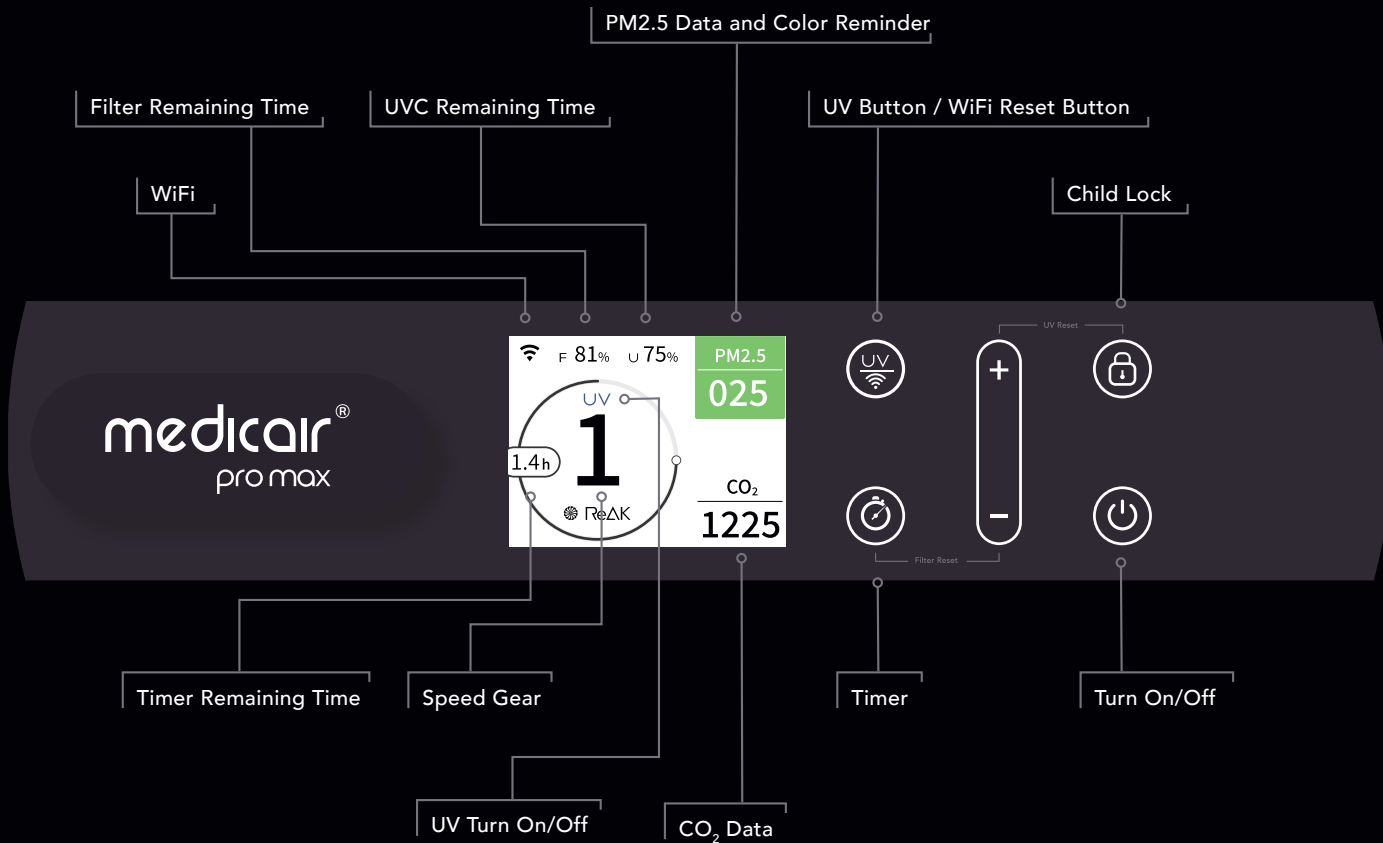

Screen Display Introduction



Start Button

When the unit is first plugged into your power supply, this button will glow indicating standby mode. To start the unit, tap this button and the unit will begin scanning the air quality within your indoor environment. MedicAir® will then default to the ReAKT setting, continually adjusting wind speed in order to achieve optimum air quality. This can be changed by pressing the Fan Speed button. To re-enter standby mode, simply press the Power button again.



Fan Speed Button

Press the fan speed button on the control panel or relevant buttons on the remote to set the fan speed at your desired level: + and - button Level 1, 2, 3, 4, ReAKT, Sleep.



Lock Timer Button

Touch the timer button icon, when the timer setting interface is displayed on the screen, touch + or - to adjust the required time, and then touch the timer button icon again to confirm, after 15 seconds of inactivity, it will be automatically confirmed.



Child Lock Button

Press and hold the child lock button  for 5 seconds to enable the child lock function. At this time, touching other buttons will not allow you to control the device; press and hold the child lock button again for 5 seconds to unlock.



Connect to Phone

Press and hold the WIFI button for  5 seconds to enter the pairing mode.

'MedicAir' Mobile App Connection Instructions

- ① **Download** the 'MedicAir' app from either the Apple App Store or Google Play store.
- ② Once in the app you will be prompted to enter an email to set up an account. **Enter your chosen email.**
- ③ You will receive an email with a **confirmation code** - find this and then enter it when prompted on the **MedicAir® app.**
- ④ You are now within the **MedicAir® App.** Ensure you accept all requests from the app to use WiFi signal.
- ⑤ **Click the + logo** in the top right of the screen to add a new device.
- ⑥ Your app will default to 'Add Manually'. In the main body of the screen should be an '**Air Purifier**' option - select this.
- ⑦ You will be prompted to **enter your WiFi passcode** - enter this and **press NEXT.**
- ⑧ At this stage you should avert your attention to the MedicAir® Air Purifier Unit. Along the bottom of the screen are 3 buttons - lightly tap the middle one (power button) and turn off the machine. Wait for 2 seconds. Again tap this button to re-boot the unit. Wait for the whole screen to stop flashing (15-20 seconds).
- ⑨ **Press and hold** the wind speed and timer buttons for 5 seconds and the WiFi logo will start flashing on the screen.
- ⑩ The WiFi logo should then begin flashing rapidly on your MedicAir® screen. At this point avert your attention back to the App and tick the box to confirm 'indicator blinking rapidly'. **Press NEXT.**
- ⑪ **Wait** whilst your unit connects. You do not need to interfere with this stage- let the unit do the work.

What to do if your unit won't connect:

- ① **Occasionally** a unit might fail to connect on the first try. The best way to mitigate this is to change the WiFi you are using.
 - ② **Complete** the process (from the step 5-11 again) but this time use a 'personal hotspot' WiFi.
 - ③ Your unit should then connect without problems.
-



STEP
5

STEP
6

STEP
7

STEP
10

STEP
11

Mobile App Connection Instructions

Before downloading this app - ensure you have set up and connected your devices via the "MedicAir® App" - see pages 12-13.

- ① Download the '**MedicAir® Data**' app from either the Apple App Store or Google Play store.
 - ② Once in the app you will be prompted to enter an email to access your account. Enter the same email you have used to login to the '**MedicAir® App**' - see pages 12-13. Enter this chosen email and press '**next**'.
 - ③ You will now be prompted for the '**Virtual ID**' to one of your existing MedicAir units. To find this navigate back to your '**MedicAir® App**' (as introduced on pages 12-13) and click on one of your units you have
- connected. Once on that unit - tap the top right corner of the screen. Once the menu comes up - press '**device information**'. Once you pass to the next screen your '**virtual ID**' will be shown - use the '**copy**' button to copy to clipboard.
- ④ Once you have copied your '**Virtual ID**' go back to the MedicAir Data App. Where prompted for a '**Virtual ID**' - simply paste your ID. Press '**next**'.
 - ⑤ You will now be requested to create a new password which will be used to access your **MedicAir® Data App**. Type and then retype this password and press '**next**'.
 - ⑥ You will now be on the home screen of your **MedicAir® Data App**. All of your devices from your **MedicAir® app** (see pages 12-13) will be shown.

- ⑦ By default you will be on the home screen on the app (see step 7 pictures on page 13). To see each of your devices listed out - press the button showing total number of devices.
- ⑧ You can learn more about how to navigate the app and all of the functionality available at our YouTube Channel - simply search for '**MedicAir®**' under channels on YouTube.

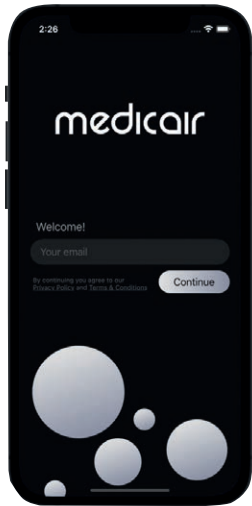

STEP
②

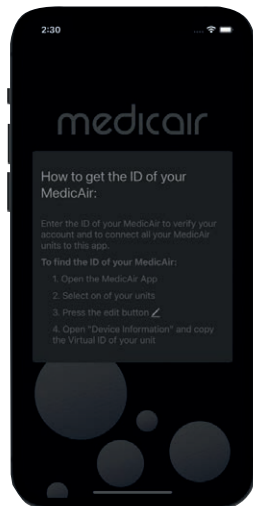

STEP
③

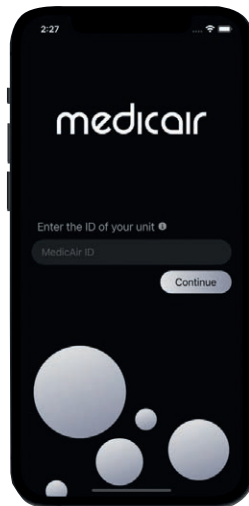

STEP
④

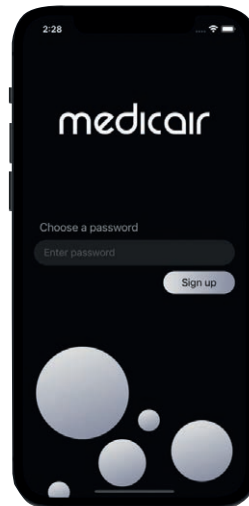

STEP
⑤

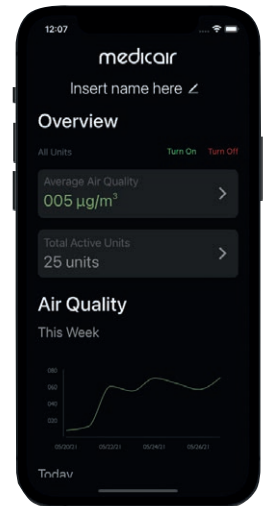

STEP
⑦

User Guide

Filter Guide Replacement/Installation

When started, the air purifier will automatically calculate the remaining usage of the filter, according to the unit's running conditions and the internally stored algorithm. When the remaining time of the filter is 0, please replace the filter in time to avoid affecting the machine performance and secondary pollution. Once you've replaced the filter, start the unit and press the sleep button for five seconds to turn the filter light off.



This appliance contains a UV-C emitter.



Please handle used filters with care and dispose of appropriately.



WARNING

This product contains a lithium button/coin cell battery. If a new or used lithium button/coin cell battery is swallowed or enters the body, it can cause severe internal burns and can lead to death in as little as 2 hours. Always completely secure the battery compartment. If the battery compartment does not close securely, stop using the product, remove the batteries, and keep it away from children. If you think batteries might have been swallowed or placed inside any part of the body, seek immediate medical attention.

Specifications

Specifications

Name:	MedicAir®
Model:	MedicAir® Pro Max-WAAMSSFL6
Rated voltage:	220V-230V
Rated frequency:	50/60Hz
Input power:	120W
Dimensions:	580(W) x 380(D) x750(H) mm
Sensors:	Laser particulate sensor (0.1-0.3um) / TVOC odour sensor
Net weight:	29kg
Standby-power:	≤2W
Noise level:	28-54dB
Indication:	LED indicators and figures
Control:	Touchscreen and WiFi

*CADR values are ±10% and given with the H14 Filter in place, values will vary depending on wind speed settings and your chosen filter configuration. Air changes influenced by obstructions and other sources of turbulence.

Parameters

H14 clean air delivery rate:	Up to 1500m ³ /h
Particulate matter CCM:	P4-level
Particulate matter purification-related energy efficiency:	10.9 (high-efficient level)
Sterilization rate:	up to 99.99%
Timer settings:	1-24 hours
Fan speed settings:	1-2-3-4-ReAKT-Sleep
Pollution-level identification:	Numerical value

Certification

Class 14 HEPA +/- Activated Carbon/UVC Filter Chamber
Model WAAMSSFL6
- Low Voltage Directive (LVD) 2006/95/EC
- Elettromagnetic Compatibility Directive (EMC) 2014/30/EU
- Radio Equipment Directive (RED) 2014/53/EU
- Restriction of the Use of Certain Hazardous Substances in Electrical and Electronic Equipment (RoHS) 2015/863/EU

Cleaning and Maintenance

- ① Always turn off the power by disconnecting the plug from the socket before carrying out maintenance, cleaning or changing the fan position.
- ② Please make sure that your air purifier is completely stopped before cleaning.
- ③ Do not attempt to clean the HEPA/ Carbon filter with a grinding sponge, scouring pad or hard brush.
- ④ Do not apply force to the filter in an effort to remove gathered particulates.
- ⑤ When not in use, please store in a dry place with good ventilation.
- ⑥ Please ensure maintenance work is carried out by an authorised service centre.
- ⑦ If the power line or plug of the appliance is damaged, immediately stop using.
- ⑧ Children must not participate or be present during the user maintenance of the product.

WARNING

- ① **RISK OF ELECTRIC SHOCK** – These servicing instructions are for use by qualified personnel only. To reduce the risk of electric shock, do not perform any servicing other than that contained in the operating instructions unless you are qualified to do so.
- ② **Disconnect power cord** before cleaning the body, air outlet or opening the bottom to avoid electric shock.
- ③ **Turn off and unplug the power cord** before replacement of the HEPA Filter, Activated Carbon Filter and the UV lamp or unit maintenance.
- ④ **If the power cord is damaged**, it must be replaced by the service center or a similarly qualified person.

Warnings

Moving

To move your air purifier ensure it's switched off and unplugged from its power source.

Installation

- » The air purifier may not work correctly if the filter cover plate is not installed properly.
- » Always ensure the inlets are more than 20cm away from anything that could obstruct the airflow, such as walls.

AC power cord

- » Do not excessively twist, pinch or bend the power cord, or the wire core will be exposed to the air and/or break.
- » Do not drag or pull the power cord when unplugging.
- » Do not use an AC socket that is not compatible.
- » Do not use the provided power cord in other devices.

In use

- » If the unit makes unusual sounds, smells, overheats, or the fan rotates irregularly, immediately turn the unit off.
- » Do not insert anything into the air inlet or outlet of the unit.
- » Keep hair, fabric and other items away from the unit as they may be sucked in, which can cause injury, and damage to the system.
- » Do not sit on the air purifier, stand too close to it or tilt it in any way.
- » Open the ventilation system when using with another combustion appliance in order to prevent carbon monoxide poisoning.

Precautions

- » The appliance is not to be used by persons (including children) with reduced physical, sensory or mental capabilities, or lack of experience and knowledge, unless they are supervised or have been given instruction.
- » Children must not play with the appliance and should be supervised around it at all times.

Warranty

Terms and conditions

MedicAir DentAir Ltd will repair any MedicAir® issue arising from a structural defect or electrical defect for a period of 3 years, without charge. The liability will not exceed the amount you originally paid for the product. The warranty does not cover defects arising from negligence, product modification, unauthorised repairs, accidental damage, theft, loss or acts of God.

In Partnership With:





Parts List:

Part Name	Part Code
Power Cord (Country Specific)	MAPCEM2
MedicAir® Unit	WAAMSSFL6
Filter Cartridge	WAAMSSFL6FC



This product helps protect against certain particulate contaminants but does not eliminate exposure to or risk of contracting disease or infection. It is NOT a Medical device.



  +44 (0)1932 553023 |  hello@medicair.co.uk

medicair.co.uk

MedicAir DentAir Ltd, The Barns, Hilltop Farm, Lyne Lane, Lyne, KT16 0AW

MedicAir® is a registered trademark of Bryant Medical Ltd in the United Kingdom, Australia and other countries.

IFU_EM_REV1.1_May 2022