



UNO 10" WALL SCONCE

SCL404

The Uno Wall Sconce is a nod to our industrial roots. Designed around a single Uno socket and shade holder, with multiple shades in various materials, the options for this series are endless. These sconces are for interior use, great fixtures in a living area, bedroom or kitchen.



FEATURES + BENEFITS

- Metal RLM shades are spun from heavy duty aluminum.
- On-Off Switch on Socket.
- Polyester powder coat finish provides color retention and scratch resistance.
- White powder coat shade interior for maximum light output. Painted galvanized finish has painted galvanized shade interior.
- UL Listed for Damp/Dry Location.
- Warranty: Limited 1 Year.
- Made in USA.

SPECIFICATIONS

Product Dimensions:

Width 10", Height 8 1/2", Depth 12 3/4", Canopy Dia. 5"

Lamping:

Max Wattage: 100W per socket

Options:

- Finish: Brushed Brass or Brushed Nickel Hardware (Arm and Socket) with choice of Slate Gray, Black, Forest Green, White Gloss, Sea Green, Navy, Architectural Bronze, Light Blue, Barn Red Shade and Canopy

Shipping:

At Montclair Light Works we proudly manufacture, assemble, and ship your lamp within 7-13 business days from our factory in Montclair CA.

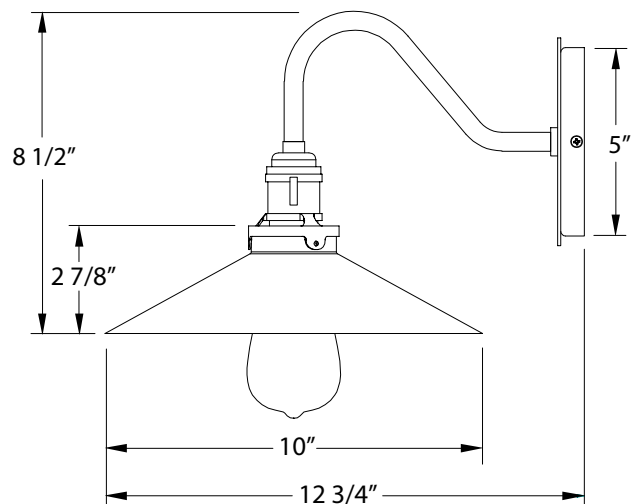

JOB/LOCATION

QUANTITY

DATE

NOTES