

5

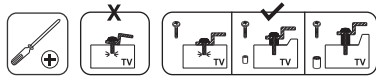

Option

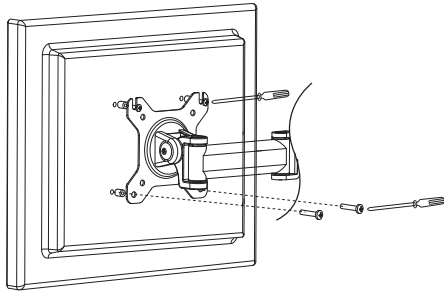

6

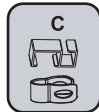
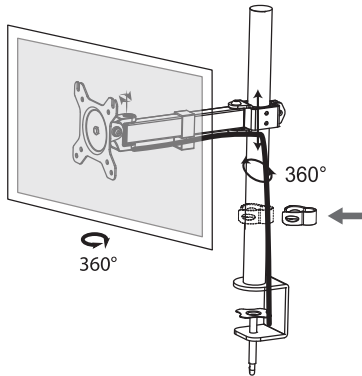

# DURONIC

www.duronic.com



EN-INSTRUCTION MANUAL  
 ES-MANUAL DE INSTRUCCIONES  
 FR-MANUEL D'INSTRUCTIONS  
 DE-BENUTZERHANDBUCH  
 IT -MANUALE DI ISTRUZIONI

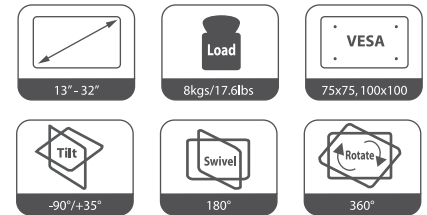

## DM151X2

Max weight 17 lbs / 8kg  
 CAUTION: DO NOT EXCEED  
 MAXIMUM LISTED WEIGHT  
 CAPACITY. SERIOUS INJURY  
 OR PROPERTY DAMAGE MAY  
 OCCUR!

## ► DISCLAIMER - WARNING INFORMATION

WARNING:FAILURE TO READ,THOROUGHLY UNDERSTAND,AND FOLLOW ALL INSTRUCTIONS CAN RESULT IN SERIOUS PERSONAL INJURY,DAMAGE TO PERSONAL PROPERTY,OR VOIDING OF FACTORY WARRANTY!

It is the responsibility of the installer to ensure all components are properly assembled and installed using the instructions provided.

If you do not understand these instructions or have any questions or concerns,please contact customer service.

Do not attempt to install or assemble this product if the product or hardware is damaged or missing. In the event that replacement parts or hardware are needed, please contact Customer Service.

International customers needing assistance should contact the Dealer from which they purchased the product.

## ► ESPAÑOL

ADVERTENCIA:NO LEER,ENTENDER CABALMENTE O SEGUIR TODAS LAS INSTRUCCIONES PUEDE DERIVAR EN LESIONES GRAVES,DAÑOS MATERIALES O LA NULIDAD DE LA GARANTIA OTORGADA POR EL FABRICANTE.

Es responsabilidad del instalador comprobar que todos los componentes estén correctamente ensamblados e instalados según las instrucciones provistas. Si usted no entiende estas instrucciones o si tiene dudas o preguntas, comuníquese con Atención al Cliente.

No instale ni ensamble el producto si éste o las piezas suministradas presentaran daños o si faltara algún elemento. Si necesita repuestos o piezas, comuníquese con Atención al Cliente.

Si reside en otro país, comuníquese con la tienda donde compró el producto.

## ► FRANÇAIS

ATTENTION:SI VOUS NE LISEZ,NI NE COMPRENEZ,NI NE SUIVEZ SOIGNEUSEMENT TOUTES CES INSTRUCTIONS,IL POURRAIT S' ENSUIVRE DES BLESSURES GRAVES,DES DOMMAGES MATÉRIELS OU L'ANNULATION DE LA GARANTIE!

L'installateur est responsable de s'assurer de l'exactitude de l'assemblage et de l'installation de toutes les composantes, conformément aux instructions fournies. Si vous ne comprenez pas ces instructions ou pour toute question ou problème, veuillez contacter le service à la clientèle.Si le produit est endommagé ou que des fixations sont manquantes ou endommagées,n'installez pas le produit.Si vous avez besoin de pièces ou de quincaillerie de rechange, veuillez contacter le Service à la clientèle Pour les clients internationaux, contactez le détaillant auprès duquel vous avez acheté le produit.

5

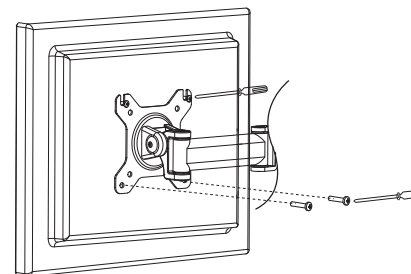
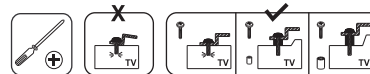

OR 4

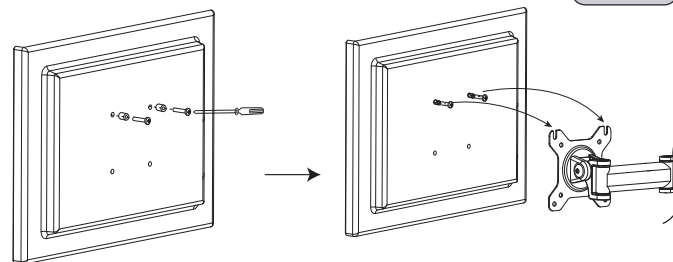
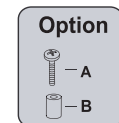
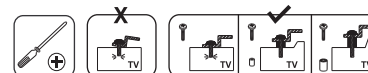

## ► DEUTSCH

**WARNUNG: LESEN SIE DIESES HANDBUCH SORGFÄLTIG DURCH UND BEFOLGEN SIE DIE ANWEISUNGEN. EINE NICHTBEACHTUNG DERSELBEN KANN ZU SCHWEREN VERLETZUNGEN, SACHSCHADEN ODER ZUM ERLÖSCHEN DER WERKSGARANTIE FÜHREN!**

Die Person, die die Montage vornimmt, hat sicherzustellen, dass alle Komponenten entsprechend den hierin bereitgestellten Anweisungen korrekt montiert und installiert werden. Sollten Sie diese Anweisungen nicht verstehen oder irgendwelche Fragen oder Zweifel diesbezüglich haben, kontaktieren Sie bitte unseren Kundendienst.

Versuchen Sie nicht, die Wandhalterung zu installieren oder montieren, wenn sie beschädigt ist oder ein Befestigungsteil fehlt. Bei Bedarf an Ersatz- oder Befestigungsteilen kontaktieren Sie bitte unseren Kundendienst. Kunden im Ausland sollten sich bei Bedarf an Hilfestellung an den Händler wenden, bei dem sie das Produkt erworben haben.

## ► ITALIANO

**AVVERTENZA: LA MANCATA LETTURA, COMPRESIONE COMPLETA, OSSERVANZA DI TUTTE LE ISTRUZIONI PUÒ COMPORTARE GRAVI LESIONI PERSONALI, DANNI A COSE O INVALIDARE LA GARANZIA DI FABBRICA.**

È responsabilità dell'installatore assicurare che tutti i componenti siano assemblati e installati correttamente, mediante l'utilizzo delle istruzioni a corredo. Nel caso in cui sorgessero incomprensioni in merito alle presenti istruzioni oppure per domande o problemi, si prega di contattare il servizio clienti al.

Non tentare di installare o assemblare il prodotto se il prodotto stesso o i componenti risultano danneggiati o mancanti. Nel caso in cui fosse necessario sostituire parti o componenti, si prega di contattare il Servizio Clienti al I Clienti internazionali che necessitano di assistenza possono rivolgersi al Rivenditore presso cui è stato acquistato il prodotto.

## TOOLS REQUIRED NOT INCLUDED

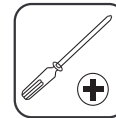

3

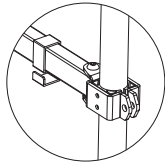

**Note: The open direction of plastic part inside should be same as the steel.**

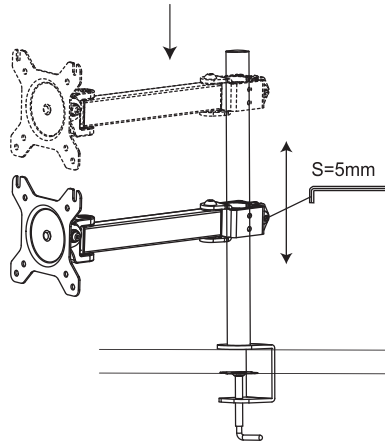



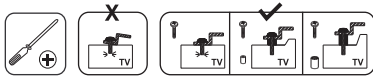



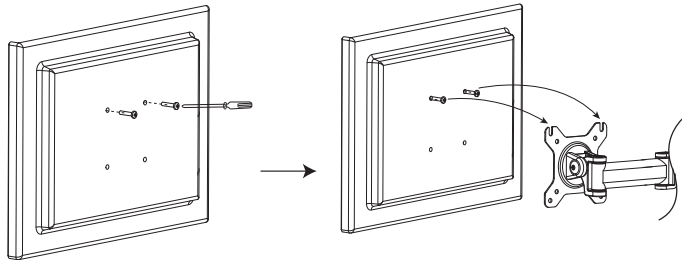

4



**Option**



# CONTENTS

A	B	
 M4x12 (x4)	 12X5.8X16 (x4)	 S=4mm (x1)
 M4x35 (x4)	 M6x15 (x3)	 S=5mm (x1)
C	D	
 (x1)	 (x1)	
 (x1)		

E



F

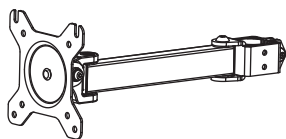

G

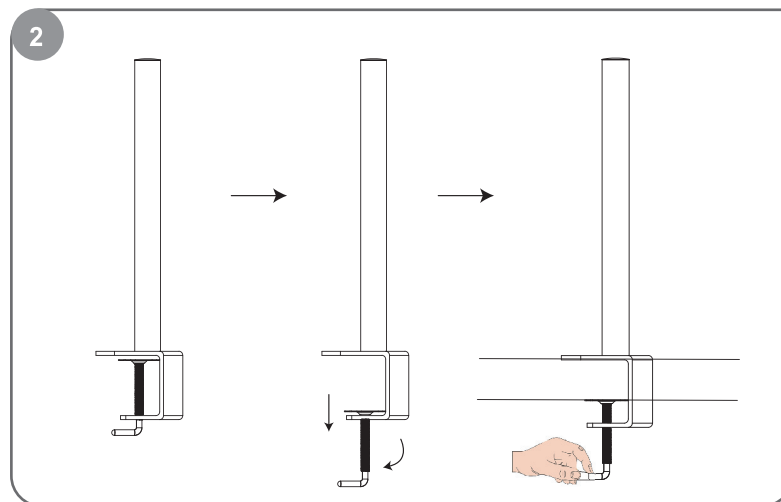
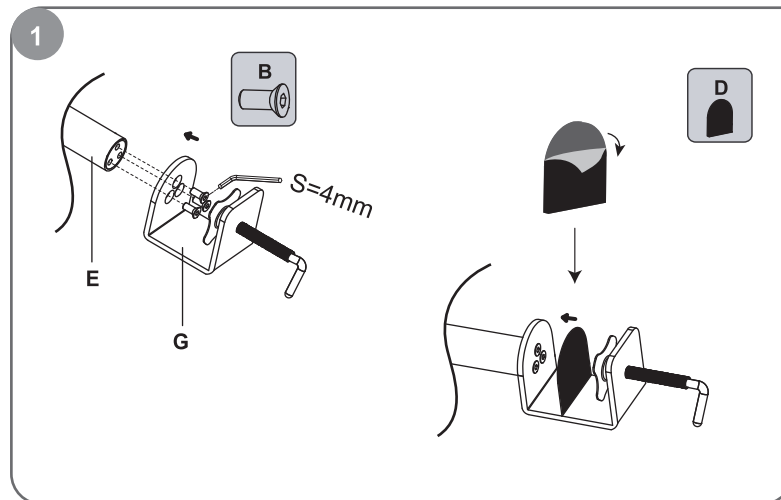
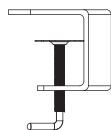

**Warning:**  
Please make sure the desktop is strong enough to hold a maximum of 20 kgs.