

# DURONIC

[www.duronic.com](http://www.duronic.com)



EN-INSTRUCTION MANUAL  
ES-MANUAL DE INSTRUCCIONES  
FR-MANUEL D'INSTRUCTIONS  
DE-BENUTZERHANDBUCH  
IT -MANUALE DI ISTRUZIONI



Desktop Load 4-15kgs/8.8-33lbs  
Keyboard Max.load 2kgs/5lbs

## DM05D3

CAUTION: DO NOT EXCEED  
MAXIMUM LISTED WEIGHT  
CAPACITY.SERIOUS INJURY  
OR PROPERTY DAMAGE MAY  
OCCUR!

## ► DISCLAIMER - WARNING INFORMATION

WARNING:FAILURE TO READ,THOROUGHLY UNDERSTAND,AND FOLLOW ALL INSTRUCTIONS CAN RESULT IN SERIOUS PERSONAL INJURY,DAMAGE TO PERSONAL PROPERTY,OR VOIDING OF FACTORY WARRANTY!

It is the responsibility of the installer to ensure all components are properly assembled and installed using the instructions provided.If you do not understand these instructions or have any questions or concerns,please contact customer service.Do not attempt to install or assemble this product if the product or hardware is damaged or missing. In the event that replacement parts or hardware are needed, please contact Customer Service. International customers needing assistance should contact the Dealer from which they purchased the product.

## ► ESPAÑOL

ADVERTENCIA:NO LEER,ENTENDER CABALMENTE O SEGUIR TODAS LAS INSTRUCCIONES PUEDE DERIVAR EN LESIONES GRAVES,DAÑOS MATERIALES O LA NULIDAD DE LA GARANTIA OTORGADA POR EL FABRICANTE.

Es responsabilidad del instalador comprobar que todos los componentes estén correctamente ensamblados e instalados según las instrucciones provistas. Si usted no entiende estas instrucciones o si tiene dudas o preguntas, comuníquese con Atención al Cliente.

No instale ni ensamble el producto si éste o las piezas suministradas presentaran daños o si faltara algún elemento. Si necesita repuestos o piezas, comuníquese con Atención al Cliente.

Si reside en otro país, comuníquese con la tienda donde compró el producto.

## ► FRANÇAIS

ATTENTION:SI VOUS NE LISEZ,NI NE COMPRENEZ,NI NE SUIVEZ SOIGNEUSEMENT TOUTES CES INSTRUCTIONS,IL POURRAIT S' ENSUIVRE DES BLESSURES GRAVES,DES DOMMAGES MATÉRIELS OU L'ANNULATION DE LA GARANTIE!

L'installateur est responsable de s'assurer de l'exactitude de l'assemblage et de l'installation de toutes les composantes, conformément aux instructions fournies. Si vous ne comprenez pas ces instructions ou pour toute question ou problème, veuillez contacter le service à la clientèle.Si le produit est endommagé ou que des fixations sont manquantes ou endommagées,n'installez pas le produit.Si vous avez besoin de pièces ou de quincaillerie de rechange, veuillez contacter le Service à la clientèle Pour les clients internationaux, contactez le détaillant auprès duquel vous avez acheté le produit.

## ► DEUTSCH

WARNUNG: LESEN SIE DIESES HANDBUCH SORGFÄLTIG DURCH UND BEFOLGEN SIE DIE ANWEISUNGEN. EINE NICHTBEACHTUNG DERSELBEN KANN ZU SCHWEREN VERLETZUNGEN, SACHSCHADEN ODER ZUM ERLÖSCHEN DER WERKSGARANTIE FÜHREN!

Die Person, die die Montage vornimmt, hat sicherzustellen, dass alle Komponenten entsprechend den hierin bereitgestellten Anweisungen korrekt montiert und installiert werden. Sollten Sie diese Anweisungen nicht verstehen oder irgendwelche Fragen oder Zweifel diesbezüglich haben, kontaktieren Sie bitte unseren Kundendienst.

Versuchen Sie nicht, die Wandhalterung zu installieren oder montieren, wenn sie beschädigt ist oder ein Befestigungsteil fehlt. Bei Bedarf an Ersatz- oder Befestigungsteilen kontaktieren Sie bitte unseren Kundendienst.Kunden im Ausland sollten sich bei Bedarf an Hilfestellung an den Händler wenden, bei dem sie das Produkt erworben haben.

## ► ITALIANO

AVVERTENZA: LA MANCATA LETTURA, COMPRESIONE COMPLETA, OSSERVANZA DI TUTTE LE ISTRUZIONI PUÒ COMPORTARE GRAVI LESIONI PERSONALI, DANNI A COSE O INVALIDARE LA GARANZIA DI FABBRICA.

È responsabilità dell'installatore assicurare che tutti i componenti siano assemblati e installati correttamente, mediante l'utilizzo delle istruzioni a corredo. Nel caso in cui sorgessero incomprensioni in merito alle presenti istruzioni oppure per domande o problemi, si prega di contattare il servizio clienti al.

Non tentare di installare o assemblare il prodotto se il prodotto stesso o i componenti risultano danneggiati o mancanti. Nel caso in cui fosse necessario sostituire parti o componenti, si prega di contattare il Servizio Clienti al

I Clienti internazionali che necessitano di assistenza possono rivolgersi al Rivenditore presso cui è stato acquistato il prodotto.

7

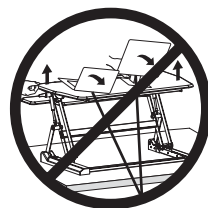
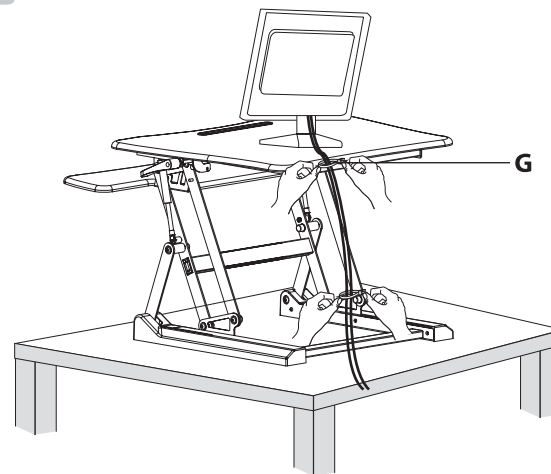

Leave enough slack in cable to allow for full range of vertical motion (15" / 38 cm). Failure to heed this warning may result in property damage and or personal injury.

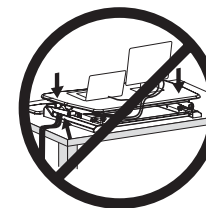

To avoid the potential to pinch cables it is important to follow the cable routing instructions in this manual.Failure to follow these instructions may result in equipment damage or personal injury.



# WARNING

## PINCH POINT

DO NOT place hands on or near support bars. Pinch points are created during lifting and lowering the worksurface. Failure to follow these instructions may result in serious personal injury.



5

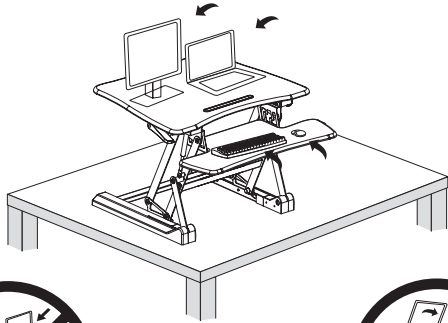

 Keep monitor and laptop base fully on the worksurface. Allowing any part of base or stand to hang off the edge may result in property damage and or personal injury.



 Raise worksurface slowly. Raising worksurface too fast may create an unstable situation resulting in property damage and or personal injury.

6

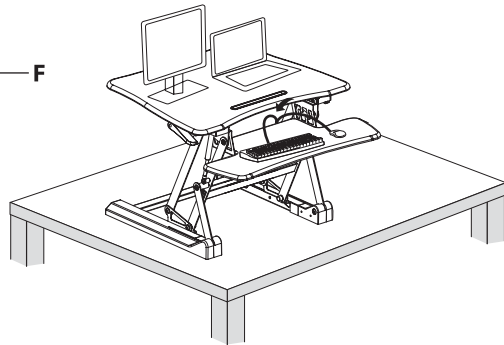
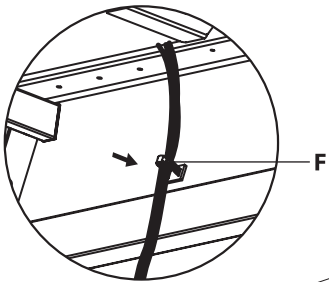



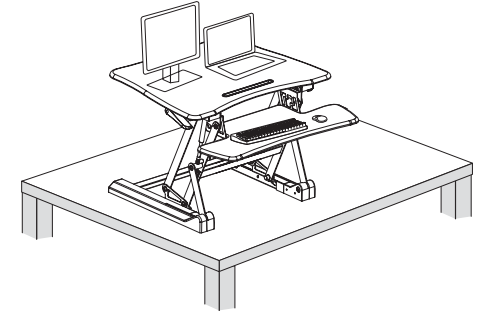
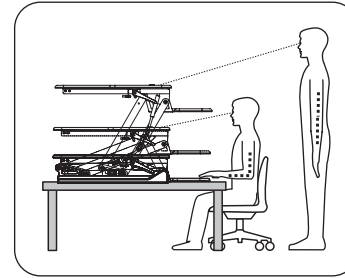

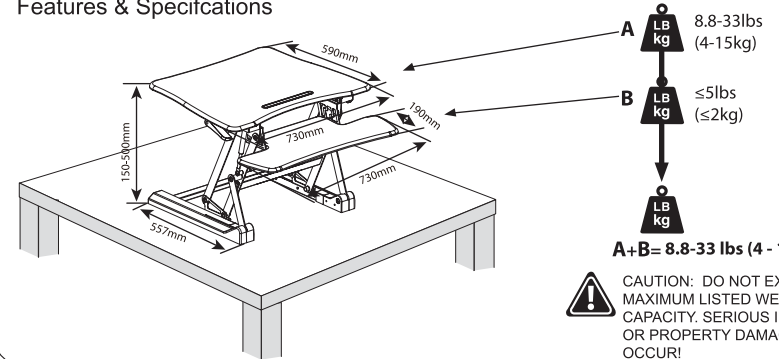

## Sit and Stand Desktop

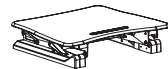

### Features & Specifications



### Components

	A	B	C	D	E	F	G
							
1	X2	X1	X6	S=4mm X1	X1	X2	

Tools required not included



1

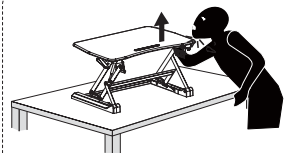
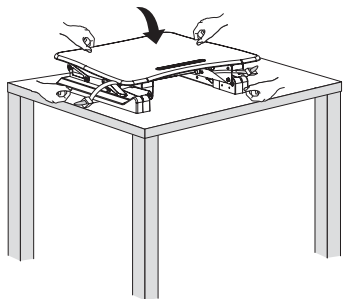
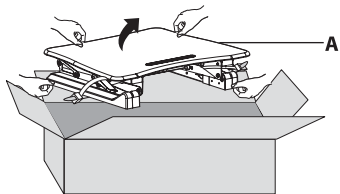

Warning: Impact Hazard! Moving Parts can Crush and Cut.

2

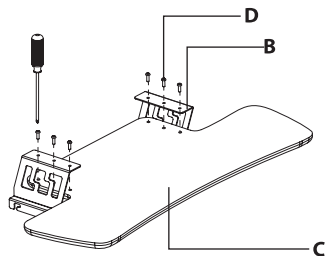
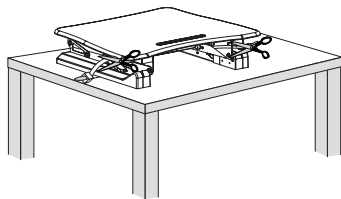

Screw up the six screws through the steel plate to the back of the keyboard tray

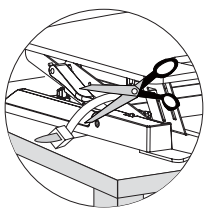

3

Press the handles in each side and lift the desktop

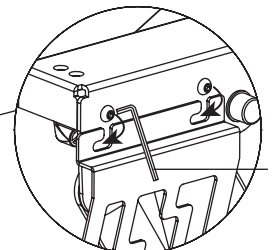
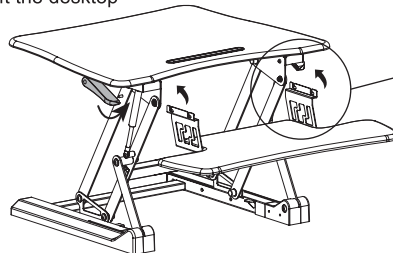

Insert the keyboard tray into the slot and fasten the screws using allen key.

4

