

d



INSTALLATION GUIDE

PRIMED WHITE SHIPLAP

Tools you will need: Measuring tape, Level, Stud Finder, Saw (Circular or Miter)
Nail gun or Hammer and Finishing Nails (18 gauge 1 ½" - 2")

Optional: Paint or Primer, Paintbrush or Paint Roller, Caulk

1. Acclimate The Boards

Remove the bundles of shiplap from the boxes and set them in the area where they will be installed to acclimate for 48 to 72+ hours.

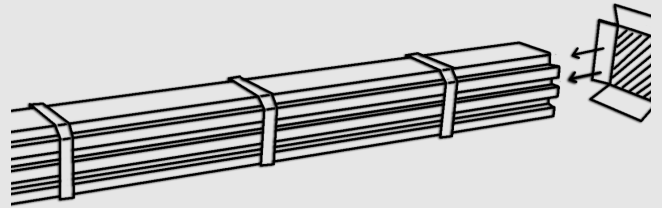

2. Prepare Your Surface

Ensure the wall surface is clean, dry, and free of any dust, debris, or old paint. Remove any existing trim or baseboards if necessary.

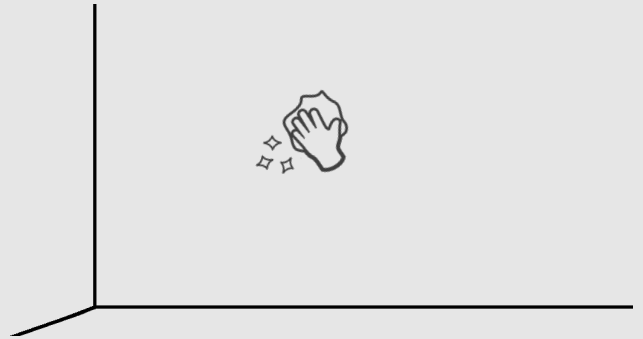

3. Mark Your Studs

Use a stud finder to locate the wall studs along the installation area. Mark the stud locations with a pencil or tape. It's important to secure the shiplap boards directly into the studs for proper support. If you cannot hit studs, use adhesive for additional support.

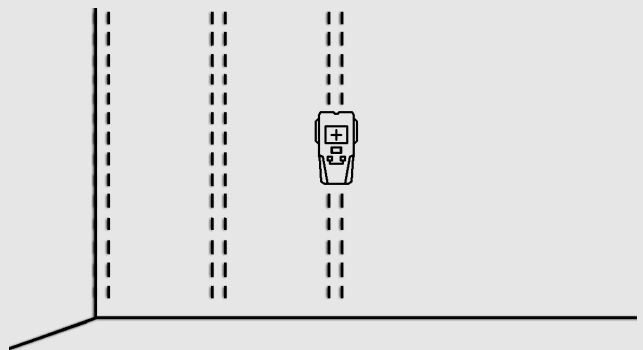

4. Mark the First Row

Measure and mark the required length for the first shiplap board. Use a saw (circular saw or miter saw) to cut the board to the desired length or install the standard 7' length.

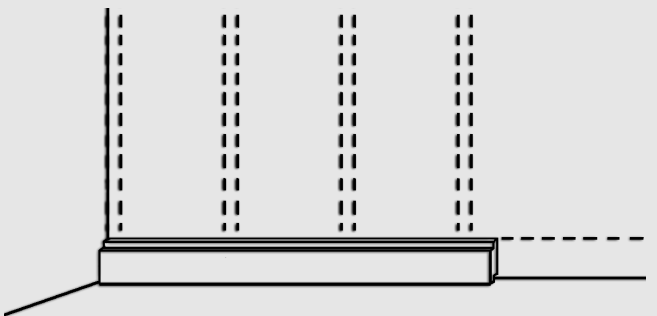

5. Placing The First Board

Start at the bottom of the wall. Place the first shiplap board horizontally, with the groove facing down and the tongue facing up. Ensure it is level before you nail through the tongue of the board into the studs.

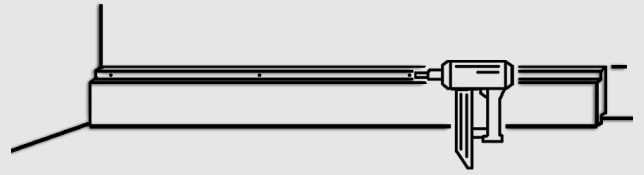

6. Secure Each Board

Insert the tongue of the next board into the groove of the first board. Secure the second board to the wall, following the same method as the Step 5. For vertical installations it is recommended to add adhesive on the back of the boards.

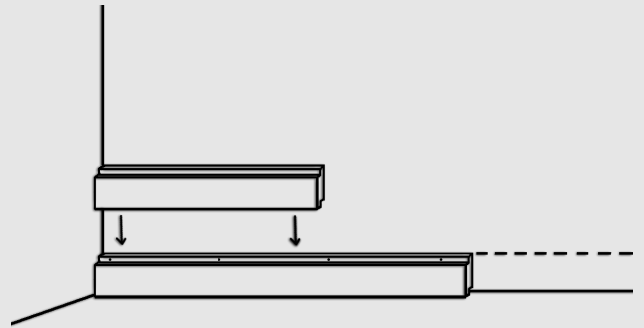

7. Repeat Until Complete

Repeat the installation process until you reach the top of the wall. Trim the last row of shiplap boards to fit the remaining space, ensuring they are securely attached to the wall and aligned with the studs.

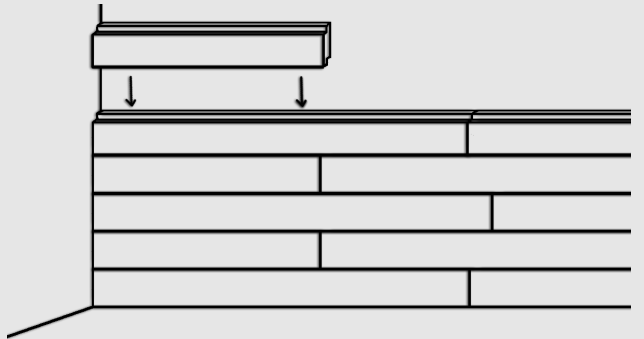

8. Corner and Edges

For corners or ends, cut the shiplap boards to the required length and angle using a saw. Fit the cut pieces into place, ensuring a tight fit and secure them to the wall. These are also compatible with most standard trim options.

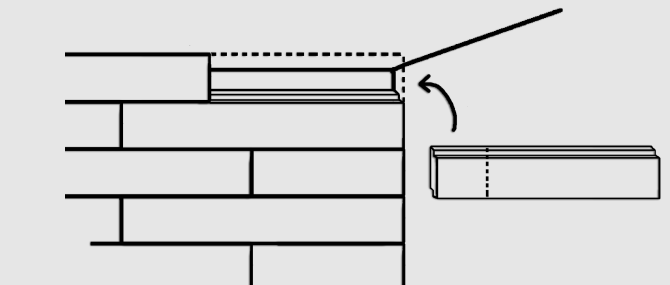

You can watch step-by-step video instructions [here](#).