



INSTALLATION GUIDE

EXTERIOR SLAT COMPOSITE CLADDING

WOODPLANK.COM

Overview

This guide will assist you in installing your WoodPlank product. While these methods are recommended by WoodPlank, they may not address every unique installation scenario. The installation approach is ultimately the responsibility of the installer. It's advised to have all designs reviewed by a licensed architect, engineer, or local building official prior to installation. Ensure your plans comply with federal, state, and local building codes.

Safety First

Safety is paramount in construction projects. WoodPlank advises wearing appropriate safety gear, including gloves, respiratory protection, long sleeves, pants, and safety glasses. Depending on the project, additional safety equipment might be necessary.

Pre-Installation Planning

Calculate your required WoodPlank cladding material by measuring your wall's square footage (length x width) and adding about 10% extra for cut waste/ overages. Plan your cladding layout in advance to achieve optimal results. Remember that most cladding projects require adherence to building codes and zoning ordinances, which often include obtaining permits and inspections from your local building department.

Getting Started

This guide provides detailed instructions for installing Exterior Plank Composite Cladding that requires no clips, except for a starter clip. The cladding is secured directly into furring strips or joists using exterior grade screws.

1. Tools Required
2. Power drill
3. Exterior grade screws
4. Measuring tape
5. Carpenter's level
6. Circular saw or handsaw
7. Starter clips
8. Safety equipment (gloves, goggles)
9. Pencil or marker for markings

Preparation

- 1. Measure and Plan:** Accurately measure the area where the cladding will be installed. Plan the layout to minimize waste and ensure a balanced appearance.
- 2. Check the Surface:** Ensure the wall surface is flat, clean, and dry. Any protruding nails or screws should be removed or flattened.
- 3. Furring Strips or Joists:** Install furring strips or joists horizontally across the wall, spaced at 16" on center. Secure the joists to the substrate with expansion screws.

Vertical Application

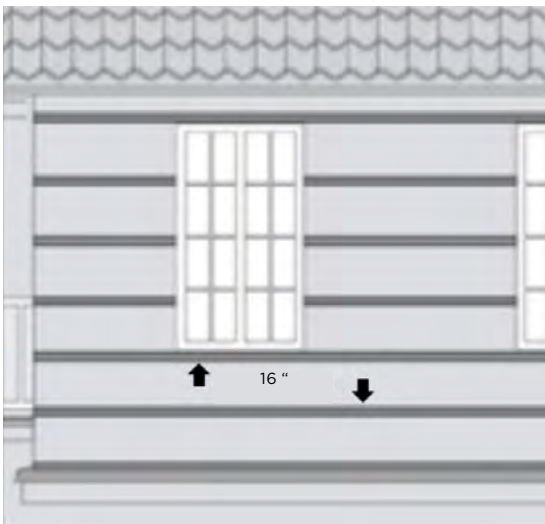

Horizontal Application

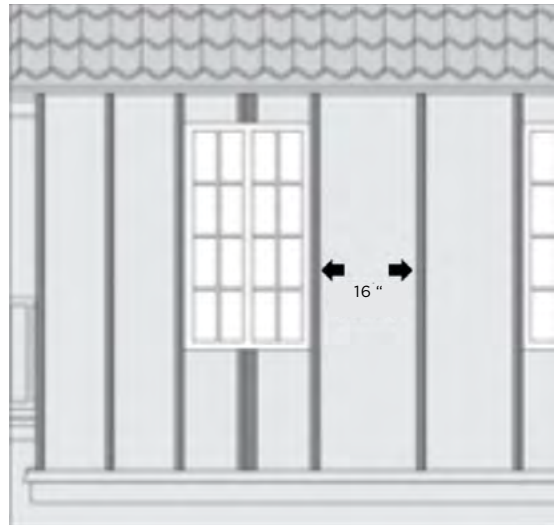

Additional Tips

Going Around Windows: When installing cladding around a window, you'll need to use two joists. Make sure that there is a joist next to the side of the window (minimum 2" width is recommended).



Installation Steps

- 1. Starter Clip Installation:** Begin at the start of the wall. Secure the starter clips to all of the furring strips or joists, ensuring they are level.

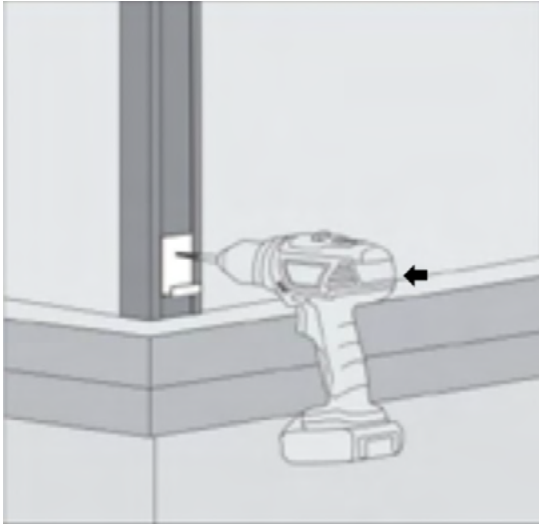

- 2. First Board Placement:** Slide the first composite board into the starter clips. Ensure the alignment is level and the tongue of the board is facing the opposite direction of your starting point.

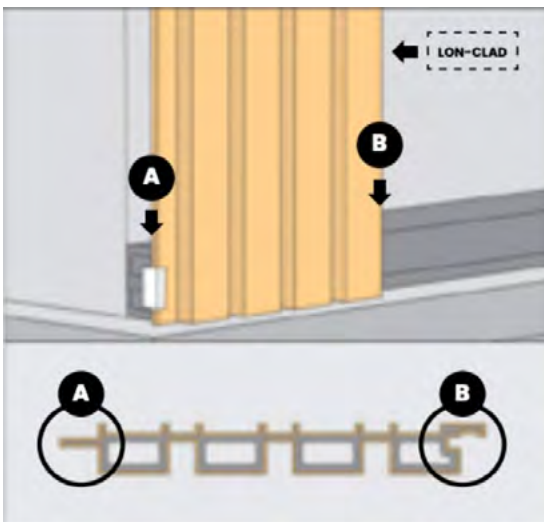

- 3. Pre-Drilling:** Mark and pre-drill holes through the tongue of the board at an angle to ensure a secure fit. Pre-drilling prevents the material from splitting and allows for easier screw insertion.

- 4. Securing the Slat Composite:** Using exterior grade screws, secure the board to the furring strips or joists through the pre-drilled holes. Ensure your screws are flush with the surface of the tongue.

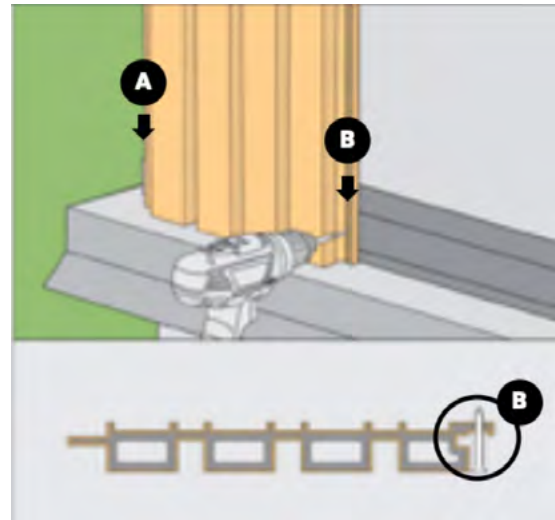

- 5. Subsequent Boards:** Align the next board so that its groove fits snugly over the tongue of the already installed board. Repeat the pre-drilling and securing process in steps #3 and #4 for each board.

- 6. Checking Alignment:** Regularly check that the boards are aligned both horizontally and vertically. Use a carpenter's level for accuracy.

7. Cutting to Fit: When necessary, cut boards to fit using a circular saw or handsaw. Measure and mark the cutting line accurately before cutting.

- a. Cut the cladding in accordance with the size of any existing framing.

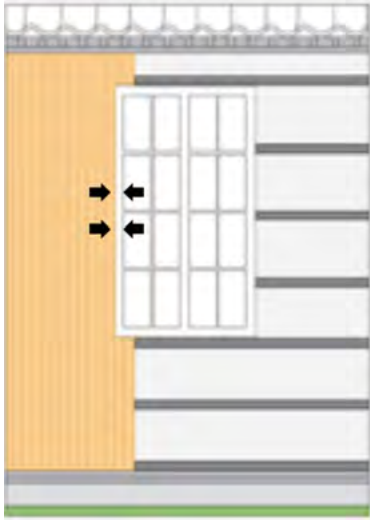

- b. Leave a gap of at least 1/8" (3mm) between the board junctions.

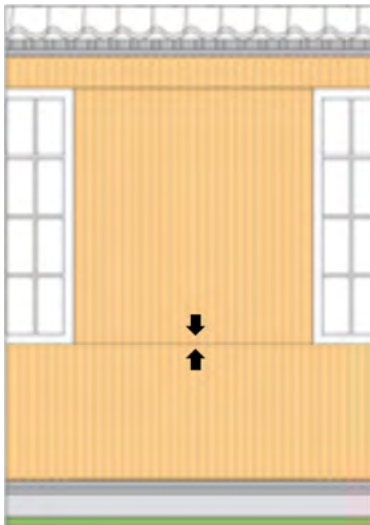

- c. Measure and cut the last piece to fit so there is no overhang or excess material.



- 8. Final Row:** For the last section, you may need to trim the board's width to fit. Ensure the final section is securely attached and level.

9. Adding Trim: The trim we offer is not mandatory, however it will provide a polished, finished look once the project is completed. Use it for the following areas:

a. **Going Around Windows:** Install L trim to cover the gap between window frame and cladding. Attach using stainless steel screws.

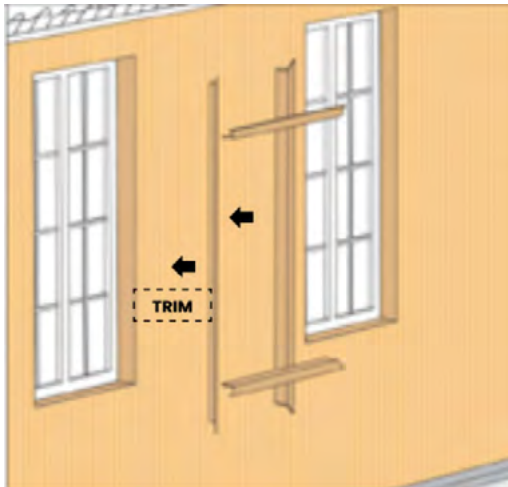

b. **Going Around Outer Corners:** Install the L trim on any external corners. Corner Trim can be installed using an exterior rated adhesive.

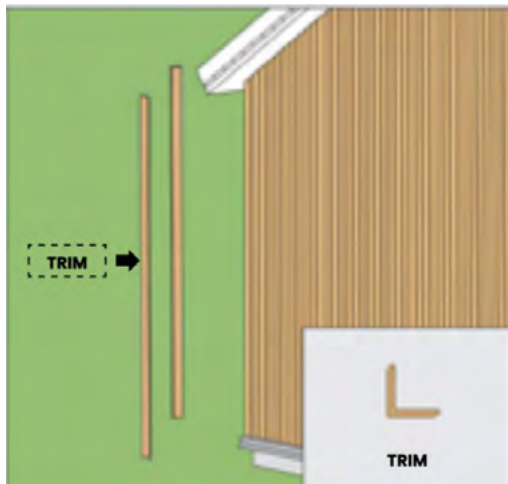

c. **Going Along The Roof:** Install the L trim on the edges of the roof, and attach using screws.

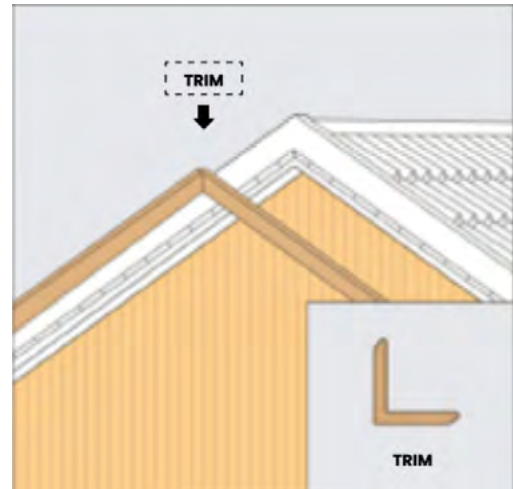

d. **Going Along Inner Corners:** Trim is not necessary for this component.

Best Practices

Expansion Gaps: Leave slight gaps (about 1/8”) at the ends of the boards to allow for thermal expansion. This may occur in environments with large temperature fluctuations.

Handling Corners: For corners, use appropriate corner trims or miter the edges of the boards for a clean finish.

Avoid Over-Tightening: When securing the boards, avoid over-tightening the screws to prevent warping or damage.

Clean as You Go: Keep the work area clean to avoid scratches or damages to the boards.

Safety First: Always wear appropriate safety equipment and follow safety guidelines while using power tools.

By following these instructions and best practices, you'll ensure a successful and visually pleasing installation of your Exterior Slat Composite Cladding.

