

# Parker Knoll

MADE IN BRITAIN | ESTABLISHED 1869



THE CLASSIC COLLECTION



At Parker Knoll we have been expertly handcrafting the finest sofas and chairs since 1869.

For over the last 150 years Parker Knoll has grown through periods of key trends and distinct style, today our collections are a reflection of this. We have become the masters of motion, the originators of style and the inventors of comfort.

We recognise that style is very personal. How you style your living space makes a statement, and is a reflection of who you are and how you live.

In style the supreme excellence is in the simplicity. That's why the Classic range offers clean, modern lines and a wide range of fabrics and leathers to choose from. We are certain you will find the perfect suite to create the centrepiece in your home.

## Visit our Showroom

Located in the heart of Long Eaton, our 3000 sq ft showroom contains a wide range of furniture from the Parker Knoll collection and is **available by appointment** for customers to visit, only 3 miles from Junction 25 of the M1 in Nottinghamshire.

We have a range of appointment options available to suit your every need. Face to face, telephone, zoom and virtual tours are all available. Visit [www.parkerknoll.co.uk/showroom](http://www.parkerknoll.co.uk/showroom) or email [parkerknollshowroom@parkerknoll.co.uk](mailto:parkerknollshowroom@parkerknoll.co.uk) to book your consultation today.



**Parker Knoll Showroom**  
Turret C, 3rd Floor  
Harrington Mills, Leopold Street,  
Long Eaton, Nottingham, NG10 4QE  
Monday - Friday, 10am - 4pm

## 25 Year Guarantee

With over 150 years' of furniture making experience, at Parker Knoll we are experts in designing and developing the best of British sofas and chairs. That's why all our furniture is supported by a 25 year frame and frame assembly guarantee – ensuring that you can find comfort in choosing Parker Knoll.



**MADE IN  
BRITAIN**

## CONTENTS

- 4 Our Story
- 6 The Fabric Collection
- 8 Crypton by Parker Knoll

### SOFAS AND ARMCHAIRS

- 10 Burghley
- 14 Ashbourne
- 18 Westbury
- 22 Canterbury
- 26 Henley
- 28 Devonshire
- 32 Etienne
- 36 Isabelle

### CHAIRS

- 38 Isabelle
- 39 Edward
- 40 Penshurst
- 42 York
- 43 Chatsworth
- 44 Mitford
- 45 Froxfield
- 46 Hartley
- 47 Sinatra

- 48 Footstool Collection
- 50 Model Specification
- 56 Additional Information

# Our Story

## 1869

### Bracklyn Street

In 1869 Frederick Parker created the business that was to become Parker Knoll from his father's factory in Bracklyn Street, London. He took pride in designing and developing the finest furniture using the best of British craftsmanship and, with the help of his sons, developed the business.

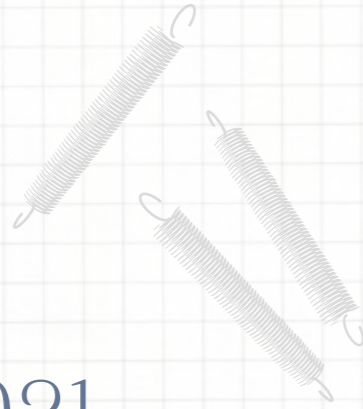

## 1921

### Revolutionary Ideas

In 1921 the Parker's met Willi Knoll; a German fighter pilot. His revolutionary ideas to modernize comfort transformed the business. The coiled wire spring system, developed to redefine comfort, remains unchanged in many of our chairs today.

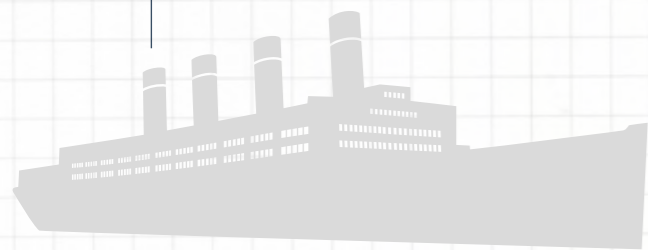

## 1914

### The War Effort

As demand continued to grow the Parker's began manufacturing furniture for Victorian gentry, which later led to furnishing the Palladian lounge of RMS Aquitania during the first world war.

## 1936

### Furnishing the BBC

In the 1930s Parker Knoll chairs were chosen to furnish most of the new BBC headquarters broadcasting house at Portland Place. In 1936, King Edward VIII presented his Empire Day Speech at the BBC sitting in a Parker Knoll chair.

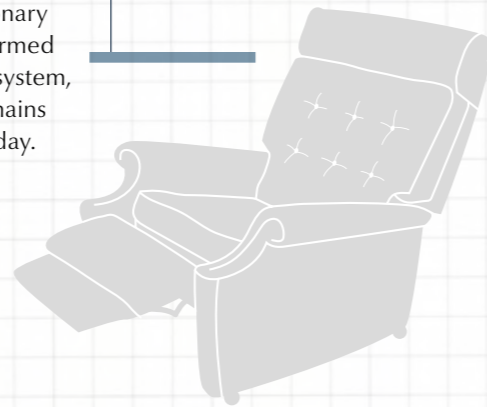
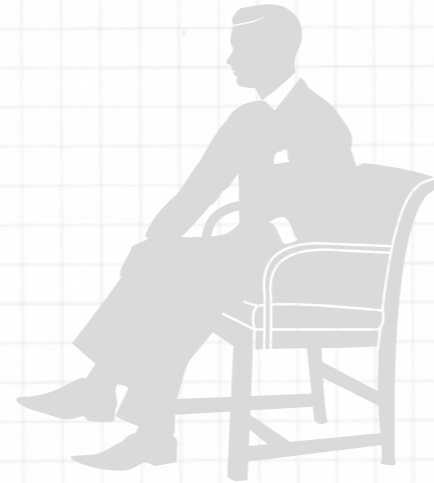

## 1960

### The Swinging 60s

For Parker Knoll the late 1960s were very definitive. The development of motion furniture began alongside iconic designs such as the Merrywood Collection and The Norton Group.

## 2016

### Castlewood, Nottinghamshire

With 147 years of knowledge and expertise, the Parker Knoll brand continues to grow. In 2016 the brand moved to a new purpose built state of the art manufacturing facility in Castlewood, Nottinghamshire. Parker Knoll's new home will help facilitate the brand's evolution in line with continuing to design and develop the best of British Sofas and Chairs that provide the ultimate in comfort.



## 1996

### Number 1 Furniture Brand

Parker Knoll is named The Number 1 Furniture Brand in the UK



## 1969

### The Statesman

With its deep buttoned back and swivel pedestal base, the Statesman Chair was an instant hit during the 60s and 70s, quickly becoming a best seller and a modern status symbol.



## 2019

### Celebrating 150 years of Parker Knoll

At Parker Knoll we have been expertly handcrafting the finest sofas and chairs since 1869. Our 150th year was celebrated with a new collection launch that pays homage to our past whilst embracing the future.

## 2017

### evolution

As Parker Knoll continues to seek new ways to redefine comfort whilst launching stylish collections of the highest possible quality, the contemporary collection, evolution, is launched.

evolution

## 2015

### Maison

Parker Knoll relaunches the Maison Collection. This new range is targeted at a younger more style-driven consumer.

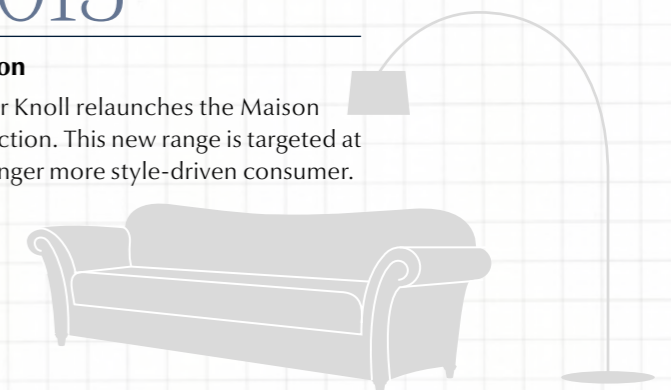



## The Fabric Collection

At Parker Knoll we have always understood the importance of elegant and luxurious fabric ranges, to help you create your suite of distinction. We are therefore delighted to present our latest collection.

The extensive fabric collection from Parker Knoll includes classic designs, stripes and plains that are a delight to touch. Whether your preference is for classic damasks, deep and rich velvets, or the softest of chenilles, there is a world of choice to help you create the perfect suite for your home.

Our design team have created a fabulous range of luxury fabrics and leathers that have been chosen on your behalf to work perfectly with our stylish furniture range. Our leathers are sourced from the best tanneries worldwide, and offer the finest of quality that look fabulous, feel soft and offer their own distinctive finish and natural characteristics.

The criteria for selection are strict - we choose our fabrics for their beautiful design, enduring quality and ultimate comfort. The entire collection is selected and tested to meet the exacting quality standards that you would expect from Parker Knoll, ensuring that your furniture will continue to delight you for years to come.

It's little wonder we've been famous for fabulous furniture since 1869.



# Crypton by Parker Knoll



Superior stain repellency makes cleaning easy

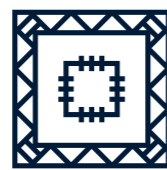

Soft, beautiful and perfectly suited for everyday living

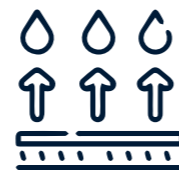

Releases both oil and water-based stains

Crypton fabrics can withstand up to anything that life throws at them. With superior stain, spill and odour resistance and permanent performance, this new collection of fabrics will give you the freedom to create a home that will stand the test of time, every time.

The new Crypton collection is a collaboration that celebrates the latest innovative techniques and creative thinking. The result? Intelligent fabrics for modern living. Together we believe that you don't have to sacrifice soft and luxurious product for the sake of performance.

Over our 150th year we have partnered with the best and Crypton is no different. For more than 25 years, Crypton have pioneered the fabric industry with innovation being the key to their success, much like Parker Knoll.



- Easycare finish
- Protection sealed into every fibre
- Practical and sustainable
- Odour resistant

We are very proud to introduce our new collection of fabrics; Crypton. Intelligent fabrics for modern living.

**Parker Knoll**  
CRYPTON

# Burghley

Beautifully proportioned and traditionally styled, Burghley is the perfect shape for detailed fabric designs and soft chenilles. Style in leather to add a classic look to your living room.

Our Burghley Armchair is now available with a Powered Footrest option to enhance your comfort experience.







# Ashbourne

Ashbourne features a stylish scroll arm and beautifully tailored back cushion. With a choice of seat interior and a Powered Footrest option, on all sizes, you can come home to comfort time and time again.





# Westbury

Exquisitely tailored and the ultimate in comfort, Westbury looks fabulous in velvet and chenille designs. Add a touch of elegance with an occasional chair in complimentary colour schemes.





# Canterbury

---

The ultimate modern classic. Choose a deep rich velvet and add pops of colour with stylish scatter cushions to create a more relaxed and casual look.





# Henley

With its high back and classic detailing, Henley is the height of comfort. This timeless shape is also available in leather and looks beautiful with traditional designs and soft chenilles. If you want to enhance your comfort experience further, the Henley armchair is available with the option of a powered footrest.



# Devonshire

With gently sweeping tailored arms and delicate detailing, Devonshire is the ultimate casual classic. Available as both a Pillow Back and Formal Back Sofa, Devonshire's versatility makes it the perfect choice for your home.

Our Devonshire Armchair is available with a Powered Footrest option to enhance your comfort experience.







# Etienne

The ultimate modern classic, Etienne is refined and elegant with a sumptuously deep seat.





# Isabelle

Make a statement with the sophisticated Isabelle Sofa Collection. With clean contemporary lines this range has a timeless and elegant feel.



# Isabelle

A charming classic. Pair with your Isabelle Sofa collection in neutral tones and bold prints, or as a stand-alone chair for that fireside corner.



# Edward

A classic button-back chair. Style with leather for a more sophisticated and classic look, or choose a lustrous chenille in bold tones as the perfect accompaniment to a pared-back living space.



# Penshurst

The classic Penshurst chair has over 70 years' worth of heritage. Experience the ultimate in comfort thanks to the coiled steel wire spring system developed by Willi Knoll himself. This classic chair is also available as a Two Seater sofa (see page 61).



# York

Relax and unwind in a York chair, available as a manual recliner for added comfort. Perfect as a stand-alone chair in a classic corner or work into your living space in complementary fabrics to your chosen suite.



# Chatsworth

Chatsworth elegantly combines the comfort of a full recliner with a classic Parker Knoll design. The only one of its kind in the collection, Chatsworth celebrates our long-standing commitment to refine the best of British designs, using the latest technology to reinvent comfort.



# Mitford

With the perfect blend of contemporary styling and classic design features, the Mitford chair is the ideal shape for any living space.



# Froxfield

An original Parker Knoll. Whether you're looking for a classic wing chair or a refined side chair, with a unique patented spring system your Froxfield chair will provide many years of comfort. Also available as Two Seater Sofa and a Side Chair (see page 62).





# Hartley

Elegant and finely tailored, the Hartley chair is designed with classic finishing touches from the gently scrolled arms to the additional piping details.



# Sinatra

A classic wing chair designed with an elegantly detailed pleated arm. The distinctive wooden frame makes this chair a show-stopping addition to your home.



# Footstool Collection

Our range of elegantly handcrafted footstools are designed to complement any of the suites across both the Classic and LifeStyle collections. Designed as simply footstools or for additional storage purposes these pieces will deliver a subtle blend of comfort and practicality to any home.

- 1+2. Large Storage Footstool in Maroc Truffle
- 3. Denham Footstool in Balenciaga Antique Red
- 4. Moseley Footstool in Baslow Stripe Gold
- 5. Winchester Footstool in Dallas Dark Brown
- 6. Large Storage Footstool in Como Dove



# Model Specification

## Burghley



**CHAIR**  
H97cm W103cm D98cm  
SH53cm SW53cm SD59cm AH65cm



**POWER FOOTREST CHAIR**  
H97cm W103cm D98cm  
SH53cm SW53cm SD59cm AH70cm

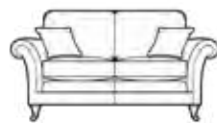

**TWO SEATER SOFA**  
INCLUDING 2 SCATTER CUSHIONS  
H97cm W176cm D98cm  
SH53cm SW120cm SD59cm AH70cm

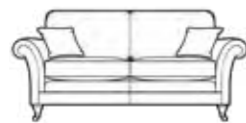

**LARGE TWO SEATER SOFA**  
INCLUDING 2 SCATTER CUSHIONS  
H97cm W206cm D98cm  
SH53cm SW150cm SD59cm AH70cm



**GRAND SOFA**  
INCLUDING 2 SCATTER CUSHIONS  
H97cm W236cm D98cm  
SH52cm SW180cm SD60cm AH70cm

OPTIONS*	STANDARD	OPTION
WOOD FINISH	TEAK	CHERRY MAHOGANY
SEAT INTERIOR	PREMIUM COMFORT FOAM	ENCORE FIBRE
FRONT LEGS	BRASS CASTOR	PLAIN TURNED WOOD CHROME CASTOR
SCATTERS	FEATHER	FIBRE
AVAILABLE IN LEATHER OR FABRIC		

## Westbury



**CHAIR**  
H100cm W95cm D95cm  
SH53cm SW51cm SD57cm AH67cm



**TWO SEATER SOFA**  
INCLUDING 2 SCATTER CUSHIONS  
H100cm W163cm D95cm  
SH53cm SW119cm SD57cm AH72cm

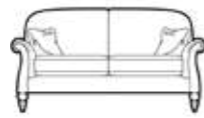

**LARGE TWO SEATER SOFA**  
INCLUDING 2 SCATTER CUSHIONS  
H100cm W190cm D95cm  
SH53cm SW146cm SD57cm AH72cm

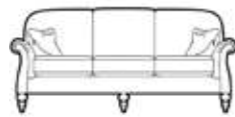

**GRAND SOFA**  
INCLUDING 2 SCATTER CUSHIONS  
H100cm W224cm D95cm  
SH53cm SW180cm SD57cm AH72cm

OPTIONS*	STANDARD	OPTION
WOOD FINISH	CHERRY	MAHOGANY TEAK
SEAT INTERIOR	PREMIUM COMFORT FOAM	ENCORE FIBRE
FRONT LEGS	BRASS CASTOR	CHROME CASTOR PLAIN TURNED WOOD
SCATTERS	FEATHER	FIBRE
AVAILABLE IN LEATHER OR FABRIC		

## Canterbury



**CHAIR**  
H94cm W94cm D95cm  
SH51cm SW44cm SD56cm AH62cm



**TWO SEATER SOFA**  
INCLUDING 2 SCATTER CUSHIONS  
H90cm W176cm D100cm  
SH51cm SW122cm SD61cm AH67cm



**LARGE TWO SEATER SOFA**  
INCLUDING 2 SCATTER CUSHIONS  
H90cm W205cm D100cm  
SH51cm SW151cm SD61cm AH67cm



**GRAND SOFA**  
INCLUDING 2 LARGE SCATTERS  
AND 2 STANDARD SCATTER CUSHIONS  
H90cm W230cm D104cm  
SH51cm SW176cm SD66cm AH67cm

OPTIONS*	STANDARD	OPTION
WOOD FINISH	CHERRY	MAHOGANY TEAK
SEAT INTERIOR	PREMIUM COMFORT FOAM	ENCORE FIBRE
SCATTERS	FEATHER	FIBRE
AVAILABLE IN LEATHER OR FABRIC		

## Henley



**CHAIR**  
H102cm W94cm D106cm  
SH54cm SW50cm SD55cm AH68cm

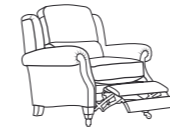

**POWER FOOTREST CHAIR**  
H102cm W94cm D106cm  
SH51cm SW50cm SD55cm AH68cm

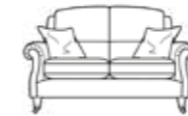

**TWO SEATER SOFA**  
INCLUDING 2 SCATTER CUSHIONS  
H102cm W153cm D106cm  
SH54cm SW109cm SD55cm AH68cm

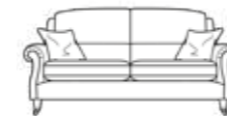

**LARGE TWO SEATER SOFA**  
INCLUDING 2 SCATTER CUSHIONS  
H102cm W208cm D106cm  
SH54cm SW164cm SD55cm AH68cm

OPTIONS*	STANDARD	OPTION
WOOD FINISH	MAHOGANY	TEAK CHERRY
SEAT INTERIOR	PREMIUM COMFORT FOAM	ENCORE FIBRE
LEG TRIM	BRASS CASTOR	PLAIN TURNED LEG CHROME CASTOR
SCATTERS	FEATHER	FIBRE
AVAILABLE IN LEATHER OR FABRIC		

## Ashbourne



**CHAIR**  
H100cm W93cm D96cm  
SH56cm SW53cm SD57cm AH69cm

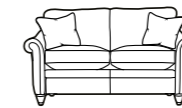

**TWO SEATER SOFA**  
INCLUDING 2 SCATTER CUSHIONS  
H100cm W162cm D96cm  
SH56cm SW122cm SD57cm AH69cm

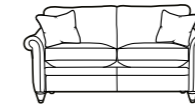

**LARGE TWO SEATER SOFA**  
INCLUDING 2 SCATTER CUSHIONS  
H100cm W186cm D96cm  
SH56cm SW146cm SD57cm AH69cm

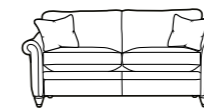

**GRAND SOFA**  
INCLUDING 2 SCATTER CUSHIONS  
H100cm W215cm D96cm  
SH56cm SW175cm SD57cm AH69cm

OPTIONS*	STANDARD	OPTION
WOOD FINISH	MAHOGANY	TEAK CHERRY
SEAT INTERIOR	PREMIUM COMFORT FOAM	ENCORE FIBRE
SCATTERS	FEATHER	FIBRE
AVAILABLE IN LEATHER OR FABRIC		

## Ashbourne



**POWER FOOTREST CHAIR**  
H100cm W93cm D96cm  
SH56cm SW53cm SD57cm AH69cm



**POWER FOOTREST TWO SEATER SOFA**  
INCLUDING 2 SCATTER CUSHIONS  
H100cm W162cm D96cm  
SH56cm SW122cm SD57cm AH69cm



**POWER FOOTREST LARGE TWO SEATER SOFA**  
INCLUDING 2 SCATTER CUSHIONS  
H100cm W186cm D96cm  
SH56cm SW146cm SD57cm AH69cm

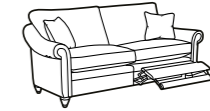

**POWER FOOTREST GRAND SOFA**  
INCLUDING 2 SCATTER CUSHIONS  
H100cm W215cm D96cm  
SH56cm SW175cm SD57cm AH69cm

OPTIONS*	STANDARD	OPTION
WOOD FINISH	MAHOGANY	TEAK CHERRY
SEAT INTERIOR	PREMIUM COMFORT FOAM	ENCORE FIBRE
SCATTERS	FEATHER	FIBRE
AVAILABLE IN LEATHER OR FABRIC		

### KEY

H	Total Height	W	Total Width	D	Total Depth		
SH	Seat Height	SW	Seat Width	SD	Seat Depth	AH	Arm Height

# Devonshire

## FORMAL BACK



**CHAIR**  
H89cm W94cm D97cm  
SH54cm SW50cm SD58cm AH63cm



**POWER FOOTREST CHAIR**  
H89cm W94cm D97cm  
SH54cm SW54cm SD58cm AH68cm

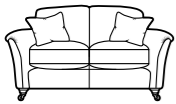

**TWO SEATER SOFA**  
INCLUDING 2 SCATTER CUSHIONS  
H95cm W163cm D97cm  
SH54cm SW117cm SD58cm AH68cm

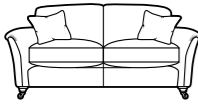

**LARGE TWO SEATER SOFA**  
INCLUDING 2 SCATTER CUSHIONS  
H95cm W192cm D97cm  
SH54cm SW150cm SD58cm AH68cm

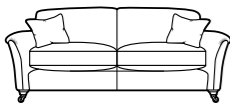

**GRAND SOFA**  
INCLUDING 2 SCATTER CUSHIONS  
H95cm W221cm D97cm  
SH54cm SW180cm SD58cm AH68cm



**SINGLE ARM END**  
Left Hand Facing or Right Hand Facing  
INCLUDING 1 SCATTER CUSHION  
H95cm W96cm D97cm  
SH54cm SW75cm SD58cm AH68cm

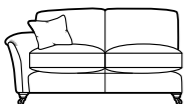

**LARGE ARM END**  
Left Hand Facing or Right Hand Facing  
INCLUDING 1 SCATTER CUSHION  
H95cm W172cm D97cm  
SH54cm SW150cm SD58cm AH68cm

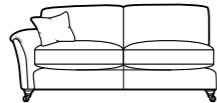

**GRAND ARM END**  
Left Hand Facing or Right Hand Facing  
INCLUDING 1 SCATTER CUSHION  
H95cm W201cm D97cm  
SH54cm SW180cm SD58cm AH68cm



**CORNER UNIT**  
INCLUDING 1 SCATTER CUSHION  
H95cm W97cm D97cm  
SH54cm SW58cm SD58cm



**CHAISE UNIT**  
Left Hand Facing or Right Hand Facing  
INCLUDING 1 SCATTER CUSHION  
H95cm W93cm D168cm  
SH54cm SW70cm SD129cm AH68cm

OPTIONS*	STANDARD	OPTION
WOOD FINISH	MAHOGANY	CHERRY TEAK
SEAT INTERIOR	PREMIUM COMFORT FOAM	ENCORE FIBRE
LEG TRIM	BRASS	CHROME SQUARE TAPERED LEG
AVAILABLE IN LEATHER OR FABRIC		

## PILLOW BACK

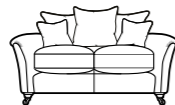

**TWO SEATER SOFA**  
INCLUDING 3 PILLOWS AND 2 SCATTER CUSHIONS  
H91cm W163cm D97cm  
SH54cm SW117cm SD58cm AH68cm

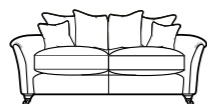

**LARGE TWO SEATER SOFA**  
INCLUDING 4 PILLOWS AND 2 SCATTER CUSHIONS  
H91cm W192cm D97cm  
SH54cm SW150cm SD58cm AH68cm

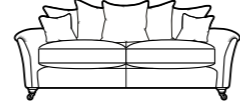

**GRAND SOFA**  
INCLUDING 5 PILLOWS AND 2 SCATTER CUSHIONS  
H91cm W221cm D97cm  
SH54cm SW180cm SD58cm AH68cm



**SINGLE ARM END**  
Left Hand Facing or Right Hand Facing  
INCLUDING 2 PILLOWS AND 1 SCATTER CUSHION  
H91cm W96cm D97cm  
SH54cm SW75cm SD58cm AH68cm

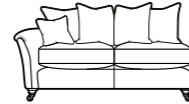

**LARGE ARM END**  
Left Hand Facing or Right Hand Facing  
INCLUDING 4 PILLOWS AND 1 SCATTER CUSHION  
H91cm W172cm D97cm  
SH54cm SW150cm SD58cm AH68cm

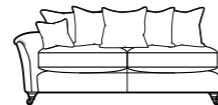

**GRAND ARM END**  
Left Hand Facing or Right Hand Facing  
INCLUDING 5 PILLOWS AND 1 SCATTER CUSHION  
H91cm W201cm D97cm  
SH54cm SW180cm SD58cm AH68cm



**CORNER UNIT**  
INCLUDING 2 PILLOWS AND 1 SCATTER CUSHION  
H91cm W97cm D97cm  
SH54cm SW58cm SD58cm



**CHAISE UNIT**  
Left Hand Facing or Right Hand Facing  
INCLUDING 2 PILLOWS AND 1 SCATTER CUSHION  
H91cm W93cm D168cm  
SH54cm SW70cm SD129cm AH68cm

OPTIONS*	STANDARD	OPTION
WOOD FINISH	MAHOGANY	CHERRY TEAK
SEAT INTERIOR	PREMIUM COMFORT FOAM	ENCORE FIBRE
LEG TRIM	BRASS	CHROME SQUARE TAPERED LEG
PILLOW BACK NOT AVAILABLE IN LEATHER		

# Etienne



**SNUSSLER**  
INCLUDING 1 STANDARD SCATTER CUSHION  
H85cm W142cm D100cm  
SH50cm SW82cm SD62cm AH73cm



**CHAISE**  
INCLUDING 1 BOLSTER  
RIGHT HAND FACING SHOWN IN ILLUSTRATION  
(ALSO AVAILABLE AS LEFT HAND FACING)  
H86cm W72cm D155cm  
SH42cm SW56cm SD98cm AH57cm

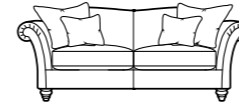

**TWO SEATER SOFA**  
INCLUDING 2 PILLOWS  
AND 2 STANDARD SCATTER CUSHIONS  
H85cm W204cm D100cm  
SH50cm SW143cm SD62cm AH73cm

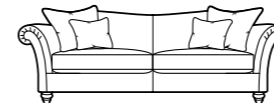

**GRAND SOFA**  
INCLUDING 2 PILLOWS  
AND 2 STANDARD SCATTER CUSHIONS  
H85cm W240cm D100cm  
SH50cm SW182cm SD62cm AH73cm

OPTIONS*	STANDARD	OPTION
WOOD FINISH	VINTAGE OAK	WALNUT
SNUSSLER SEAT INTERIOR	PREMIUM COMFORT FOAM	ENCORE FIBRE
GRAND/TWO SEATER SEAT INTERIOR	PREMIUM COMFORT FOAM	ENCORE FIBRE
SCATTERS	FEATHER	FIBRE

# Isabelle



**CHAIR**  
INCLUDING 1 RECTANGULAR BOLSTER  
H82cm W87cm D97cm  
SH45cm SW49cm SD51cm AH59cm



**SNUSSLER**  
INCLUDING 1 LARGE SCATTER CUSHION  
H77cm W136cm D102cm  
SH45cm SW79cm SD65cm AH76cm

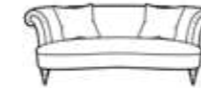

**TWO SEATER SOFA**  
INCLUDING 2 LARGE SCATTER CUSHIONS  
H77cm W192cm D102cm  
SH45cm SW131cm SD65cm AH76cm

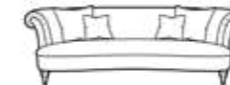

**LARGE TWO SEATER SOFA**  
INCLUDING 2 LARGE SCATTERS  
AND 2 STANDARD SCATTER CUSHIONS  
H77cm W220cm D102cm  
SH45cm SW163cm SD65cm AH76cm



**FOOTSTOOL**  
H38cm W124cm D66cm

OPTIONS*	STANDARD	OPTION
WOOD FINISH	VINTAGE OAK	WALNUT
SCATTERS	FEATHER	FIBRE

# Chairs

## Chatsworth



CHAIR  
ONLY AVAILABLE IN POWER OPTION  
H100cm W80cm D90cm  
Full Recline 162cm  
SH49cm SW48cm SD53cm AH59cm

OPTIONS*	STANDARD	OPTION
WOOD FINISH	MAHOGANY	CHERRY TEAK
LEG TRIM	BRASS	CHROME
AVAILABLE IN LEATHER OR FABRIC		
AVAILABLE WITH CORDLESS POWER		

## Froxfield

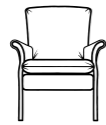

SIDE CHAIR  
H82cm W72cm D81cm  
SH43cm SW46cm SD50cm AH55cm

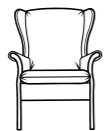

WING CHAIR  
H96cm W72cm D88cm  
SH43cm SW46cm SD50cm AH55cm

## Mitford



CHAIR  
H104cm W75cm D90cm  
SH47cm SW56cm SD56cm AH62cm

OPTIONS*	STANDARD	OPTION
WOOD FINISH	CHERRY	TEAK MAHOGANY
LEG TRIM	BRASS CASTOR	CHROME CASTOR
SEAT INTERIOR	FIBRE	FOAM

## Edward



CHAIR  
H102cm W77cm D90cm  
SH45cm SW42cm SD55cm AH60cm

OPTIONS*	STANDARD	OPTION
WOOD FINISH	CHERRY	ANTIQUÉ WALNUT MAHOGANY TEAK
AVAILABLE IN LEATHER OR FABRIC		

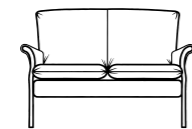

TWO SEATER SOFA  
H82cm W126cm D81cm  
SH43cm SW99cm SD50cm AH55cm

OPTIONS*	STANDARD	OPTION
WOOD FINISH	TEAK	ANTIQUÉ WALNUT MAHOGANY CHERRY

## Penshurst



WING CHAIR  
H99cm W78cm D87cm  
SH44cm SW49cm SD51cm AH58cm



TWO SEATER SOFA  
H99cm W137cm D87cm  
SH44cm SW108cm SD51cm AH58cm



FOOTSTOOL  
H43cm W65cm D46cm

## Hartley



WING CHAIR  
H105cm W75cm D77cm  
SH52cm SW47cm SD50cm AH66cm

OPTIONS*	STANDARD	OPTION
WOOD FINISH	ANTIQUÉ WALNUT	TEAK MAHOGANY CHERRY

OPTIONS*	STANDARD	OPTION
WOOD FINISH	ANTIQUÉ WALNUT	MAHOGANY TEAK CHERRY
AVAILABLE IN LEATHER OR FABRIC		

# Chairs & Footstools

## Sinatra



WING CHAIR  
H104cm W88cm D89cm  
SH48cm SW50cm SD51cm AH60cm

OPTIONS*	STANDARD	OPTION
WOOD FINISH	CHERRY	MAHOGANY TEAK
SEAT INTERIOR	FIBRE	FOAM
AVAILABLE IN LEATHER OR FABRIC		

## Small storage

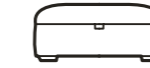

SMALL STORAGE FOOTSTOOL  
H38-46cm\*\* W70cm D62cm

OPTIONS*	STANDARD	OPTION
WOOD FINISH	MAHOGANY	CHERRY TEAK WALNUT WASHED OAK BRUSHED STEEL
LEG TRIM	SHROUD	MANHATTAN EVOLUTION
NOTE: NOT ALL WOOD FINISHES ARE AVAILABLE WITH EVERY LEG TRIM. **HEIGHT DEPENDENT ON CHOSEN LEG		
AVAILABLE IN LEATHER OR FABRIC		

## Moseley



MOSELEY FOOTSTOOL  
H36cm\*\* W74cm D63cm

OPTIONS*	STANDARD	OPTION
LEGS	WESTBURY	BURGHLEY HENLEY
WOOD FINISH	CHERRY	MAHOGANY TEAK
LEG TRIM	BRASS CASTOR	CHROME CASTOR
**HEIGHT DEPENDENT ON CHOSEN LEG		
AVAILABLE IN LEATHER OR FABRIC		

## York



WING CHAIR  
H99cm W79cm D90cm  
SH48cm SW46cm SD53cm AH58cm

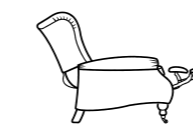

MANUAL RECLINER CHAIR  
H99cm W79cm D90cm  
Full Recline 159cm  
SH48cm SW46cm SD53cm AH58cm

## Large storage

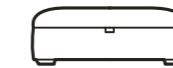

LARGE STORAGE FOOTSTOOL  
H38cm W89cm D62cm

OPTIONS*	STANDARD	OPTION
WOOD FINISH	MAHOGANY	TEAK
AVAILABLE IN LEATHER OR FABRIC		

## Winchester

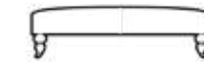

WINCHESTER FOOTSTOOL  
H39cm\*\* W127cm D59cm

OPTIONS*	STANDARD	OPTION
LEGS	WESTBURY	BURGHLEY DEVONSHIRE HENLEY
WOOD FINISH	CHERRY	MAHOGANY TEAK
LEG TRIM	BRASS CASTOR	CHROME CASTOR
**HEIGHT DEPENDENT ON CHOSEN LEG		
AVAILABLE IN LEATHER OR FABRIC		

## Denham



DENHAM FOOTSTOOL  
H44cm W58cm D58cm

OPTIONS*	STANDARD	OPTION
WOOD FINISH	CHERRY	MAHOGANY TEAK

## Lift top



LIFT TOP FOOTSTOOL  
H44cm W69cm D54cm

OPTIONS*	STANDARD	OPTION
WOOD FINISH	MAHOGANY	ANTIQUÉ WALNUT CHERRY TEAK
LEG TRIM	BRASS CASTOR	CHROME CASTOR
SEAT INTERIOR	FOAM	QUALLOFIL FIBRE
AVAILABLE IN LEATHER OR FABRIC		

OPTIONS*	STANDARD	OPTION
WOOD FINISH	CHERRY	MAHOGANY TEAK
AVAILABLE IN LEATHER OR FABRIC		

## Visit our Showroom

Located in the heart of Long Eaton, our 3000 sq ft showroom contains a wide range of furniture from the Parker Knoll collection and is **available by appointment** for customers to visit, only 3 miles from Junction 25 of the M1 in Nottinghamshire.

We have a range of appointment options available to suit your every need. Face to face, telephone, zoom and virtual tours are all available. Visit [www.parkerknoll.co.uk/showroom](http://www.parkerknoll.co.uk/showroom) or email [parkerknollshowroom@parkerknoll.co.uk](mailto:parkerknollshowroom@parkerknoll.co.uk) to book your free consultation today.



**Parker Knoll Showroom,**  
Turret C, 3rd Floor  
Harrington Mills, Leopold Street,  
Long Eaton, Nottingham, NG10 4QE  
Monday - Friday, 10am - 4pm

## Additional Information

### Wood Finishes

Wood colour options can vary for each model in the range, please see the options below each model in the specification or ask in store for further details. Please note that the Vintage Oak and Walnut wood finishes are only available on Etienne and Isabelle.



Cherry

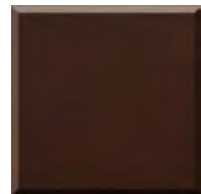

Mahogany



Vintage Oak



Teak

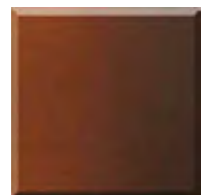

Antique Walnut  
ACCENT CHAIRS ONLY

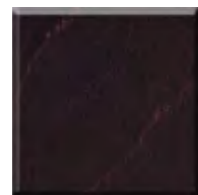

Walnut

## Options\*

All options are available at no additional charge. PLEASE STATE YOUR CHOICE CLEARLY WHEN ORDERING. Your order will be supplied with the standard finish unless you state the option.

## 25 Year Guarantee

With over 150 years' of furniture making experience, at Parker Knoll we are experts in designing and developing the best of British Sofas and Chairs. That's why all our furniture is supported by a 25 year frame and frame assembly guarantee – ensuring that you can find comfort in choosing Parker Knoll.



Every Parker Knoll piece is handcrafted to order in our state-of-the-art factory in rural Nottinghamshire. Our founders commitment is still at the heart of everything that we do: to produce beautiful, high-quality designs with the utmost style

## Premium Comfort Foam



Premium Comfort Foam has been developed by Parker Knoll in conjunction with a leading foam supplier to create a supremely comfortable seating experience.

This seat interior option has a foam core and super soft topper, creating pockets of air when you sit and offering excellent recovery properties with an elegant, tailored appearance.

Premium Comfort Foam will conform to your body shape, perfectly ensuring you have a premium comfort experience.

Premium Comfort is the standard seat interior on all suites, with the exception of Isabelle.

## Encore

Encore seat interiors are available on the following models: Burghley, Westbury, Canterbury, Henley, Etienne, Devonshire and Ashbourne.



## Quallofil

Quallofil seat interiors are available on the following models: York, Sinatra and Mitford.



## Fabric Combinations

The sofas in the range are offered in a combination finish. When a combination is selected please adhere to the following formats:

**Burghley, Westbury, Canterbury, Henley, Devonshire Formal Back and Ashbourne:**

Fabric 1: Body, seat and back cushion and one side of scatter cushions

Fabric 2: Opposite side of scatter cushions

**Isabelle Two Seater Sofa, Chair and Snuggler; Etienne Snuggler and Chaise:**

Fabric 1: Body, seat and back cushion

Fabric 2: Scatter cushion or bolster

**Isabelle Large Two Seater, Etienne Sofas and Devonshire Pillow Back Sofas:**

Fabric 1: Body, seat and back cushions

Fabric 2: Pillows (Etienne and Devonshire Pillow Back) or large scatters (Isabelle)

Fabric 3: Scatter cushions

## Choosing Leather

It is important to understand the characteristics of leather when choosing to purchase this type of sofa. Leather suites are classic and timeless; the high quality, natural and hard wearing leathers we offer look great and are really easy to care for. It is key to note that leather will move over time and may display traces of the past such as healed scars, insect bites, growth marks and veins. These are all hallmarks of hide and in no way detract from the wearing qualities of leather.

## Fabrics

All Parker Knoll fabrics are available as cut lengths and can be supplied (to the nearest half metre). When ordering, please state the fabric and colour reference clearly. Leather is not available as a cut length.

Some fabrics in the collection may only be available to order on scatter cushions, chairs and other accent pieces. Please refer to the swatch books in store for further information.

## Fabric Samples

Fabric samples are available on request from our website; we endeavour to deliver within 2-3 working days.

Please refer to our website for up to date lead times. [www.parkerknoll.co.uk/fabrics/](http://www.parkerknoll.co.uk/fabrics/)

## Railroaded Fabrics

### SELECTING A NON-RAILROADED FABRIC

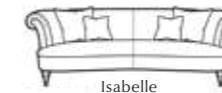

The design of a non-railroaded fabric will require a different manufacturing method which will slightly alter the appearance of the Isabelle sofas as follows:

The Isabelle Large Two Seater Sofa and Two Seater Sofa will have a centre seam running through the back, seat and front border.

### SELECTING A RAILROADED FABRIC

If a fabric is railroaded, it will state clearly on the back of each fabric in the swatch. A railroaded fabric will have no joins on the back seats.

Please note that railroaded fabrics are not suitable for curtains; please refer to the swatch books in store for further information.

## Sofa Buying Guide

Are you still unsure about the right sofa for you? Our handy, online sofa buying guide will steer you in the right direction. It covers everything from selecting the proper size, fabric, style and interior. We recommend referring to our guide for further advice to ensure you create your perfect sofa.

---

## Choosing Fabrics

When choosing a Parker Knoll fabric, it is advisable to think about the environmental and lifestyle factors that may impact upon fabric behaviour.

We recommend that you do not expose your upholstery to long periods of direct sunlight, as this may result in fading. Close and constant exposure to heat can also influence colouration so it is important to consider where in the room your sofa will be placed when choosing fabric.

It is also key to consider the fabric type and its associate behaviours and characteristics. A fabric with a pile direction such as chenilles or velvets may naturally flatten and be influenced by pressure or shade as the fibres change.

Appropriate care of your upholstery will ensure your velvet or chenille furniture looks fabulous and stands the test of time.

All of the fabrics within the Parker Knoll fabric collection are tested for use in a domestic environment.

You will find information regarding the fabric composition on the label on your samples or on the back of each swatch in our in store sample books.

If you have any questions or queries regarding your chosen fabrics please visit a Parker Knoll retailer or contact our customer support team who will be happy to assist you. For more information visit [www.parkerknoll.co.uk](http://www.parkerknoll.co.uk).

---

## Pattern Repeats and Widths

Please refer to the swatch books in store for further information.

---

## Accessories

**Please Note: Some of our images are shown with scatters to enhance the look. Please check the model specification for details on which models include scatters, as per the line drawing.**

Additional scatter cushions are available, where not already included, as chargeable extras on all models. Scatter interiors are also available with a choice of feather or fibre filling. Scatters can be made in any fabric within the Parker Knoll collection. Classic scatter cushions come self-piped. Pillow Back cushion interiors have a mixture of feathers and fibre fillings.

---

## Footstools

The height of the Winchester and Moseley footstools will vary depending on your choice of leg. Please ask in store for further details.

---

## Arm Caps

Specifically tailored full length arm caps are available as chargeable extras on most models. These arm caps can be made in any fabric within the Parker Knoll collection and are fully lined.

---

## Arm Height

The overall dimensions of the Burghley and Canterbury sofas and chairs are the same. The arm height of the chair is lower than the sofa for optimum seating comfort.

---

## BSI ISO 9001



Parker Knoll Upholstery is proud to have been awarded the BSI ISO 9001 QMS certificate. This is your assurance that we at Parker Knoll comply with stringent quality standards. Our products are regularly subjected to independent testing to ensure safety, product performance, and reliability. The ISO 9001 QMS at Parker Knoll is continually assessed demonstrating our commitment to continual improvement, customer satisfaction and always maintaining the highest possible standards.

---

## Crypton by Parker Knoll

Crypton fabrics can withstand anything life throws at it. With superior stain, spill and odour resistance and permanent performance this collection of fabrics will give you the freedom to create a home that will stand the test of time, every time, without compromise. For more information or to experience the full collection find your nearest stockist at [www.parkerknoll.co.uk](http://www.parkerknoll.co.uk).

---

We have tried to be as accurate as possible in the presentation of information. However, some dimensions shown should be regarded as approximate only, due to the nature of upholstery fabrics used.

Parker Knoll has a policy of continual development and improvement, and therefore advises that current specifications should be checked prior to ordering.

Parker Knoll reserve the right to alter specifications and to discontinue models and fabrics without notice.

Due to varying lighting conditions during photography and limitations in digital and printing technology, colours in this catalogue may vary from actual materials. Furthermore, sofa images have been altered to enhance their natural beauty.

Some cushions, rugs and accessories shown in the brochure are not manufactured by Parker Knoll. Some fabrics may not be available on selected models. Please see the availability chart at the back of a swatch in store for more details.



# Parker Knoll

## Parker Knoll Head Office

Parker Knoll Upholstery Limited,  
Castlewood Business Park,  
Farmwell Lane, Sutton in Ashfield,  
Nottinghamshire NG17 1BX  
Postcode for Sat Nav: NG17 1JF

Tel 01773 604 121 Fax 01773 540 084

Email [customer.support@parkerknoll.co.uk](mailto:customer.support@parkerknoll.co.uk)  
[www.parkerknoll.co.uk](http://www.parkerknoll.co.uk)





A Sofa Brands International Company  
All images are copyrighted © 2005-2023 Parker Knoll.  
February 2023 /1st Edition 138

## Parker Knoll Showroom

Turret C, 3rd Floor,  
Harrington Mills,  
Leopold Street, Long Eaton  
Nottinghamshire, NG10 4QE

To book an appointment visit  
[www.parkerknoll.co.uk/showroom](http://www.parkerknoll.co.uk/showroom)  
or call us on 01773 604 121 or email  
[showroom@parkerknoll.co.uk](mailto:showroom@parkerknoll.co.uk)

Photography: [laurence-dutton.com](http://laurence-dutton.com),  
[benanders.co.uk](http://benanders.co.uk), [jondayphotography.com](http://jondayphotography.com)

-  [facebook.com/ParkerKnollUpholsteryLtd](https://facebook.com/ParkerKnollUpholsteryLtd)
-  [twitter.com/\\_ParkerKnoll](https://twitter.com/_ParkerKnoll)
-  [pinterest.com/ParkerKnoll](https://pinterest.com/ParkerKnoll)
-  [instagram.com/parkerknoll](https://instagram.com/parkerknoll)

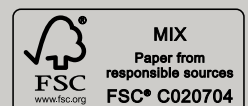

# Parker Knoll

MADE IN BRITAIN | ESTABLISHED 1869



THE LIFESTYLE COLLECTION



At Parker Knoll we have been expertly handcrafting the finest sofas and chairs since 1869.

For over the last 150 years Parker Knoll has grown through periods of key trends and distinct style, today our collections are a reflection of this. We have become the masters of motion, the originators of style and the inventors of comfort.

We recognise that style is very personal. How you style your living space makes a statement, and is a reflection of who you are and how you live.

Simplistic style is key to supreme excellence. That's why the LifeStyle range offers clean, modern lines and a wide range of fabrics and leathers to choose from. We are certain you will find the perfect suite to create the centrepiece in your home.

## Visit our Showroom

---

Located in the heart of Long Eaton, our 3000 sq ft showroom contains a wide range of furniture from the Parker Knoll collection and is **available by appointment** for customers to visit, only 3 miles from Junction 25 of the M1 in Nottinghamshire.

We have a range of appointment options available to suit your every need. Face to face, telephone, zoom and virtual tours are all available. Visit [www.parkerknoll.co.uk/showroom](http://www.parkerknoll.co.uk/showroom) or email [parkerknollshowroom@parkerknoll.co.uk](mailto:parkerknollshowroom@parkerknoll.co.uk) to book your consultation today.



**Parker Knoll Showroom**  
Turret C, 3rd Floor  
Harrington Mills, Leopold Street,  
Long Eaton, Nottingham, NG10 4QE  
Monday - Friday, 10am - 4pm

## 25 Year Guarantee

---

With over 150 years' of furniture making experience, at Parker Knoll we are experts in designing and developing the best of British sofas and chairs. That's why all our furniture is supported by a 25 year frame and frame assembly guarantee – ensuring that you can find comfort in choosing Parker Knoll.



**MADE IN  
BRITAIN**

## CONTENTS

---

- 4 Our Story
- 6 The Fabric Collection
- 8 Crypton by Parker Knoll

### SOFAS AND ARMCHAIRS

---

- 10 Dakota
- 14 Manhattan
- 18 Colorado
- 22 Hudson
- 26 Boston
- 30 Hampton
- 34 Michigan

### CHAIRS

---

- 36 Norton 150
- 

- 38 Comfort in Motion
- 39 Norton 150 Rise & Recline
- 40 Model Specification
- 45 Additional Information

# Our Story

## 1869

### Bracklyn Street

In 1869 Frederick Parker created the business that was to become Parker Knoll from his father's factory in Bracklyn Street, London. He took pride in designing and developing the finest furniture using the best of British craftsmanship and, with the help of his sons, developed the business.

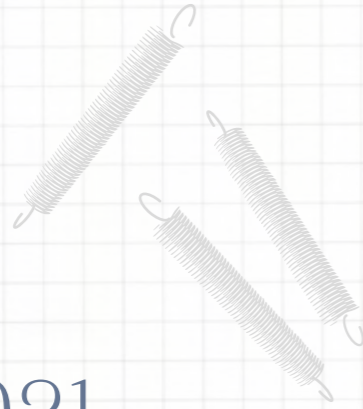

## 1921

### Revolutionary Ideas

In 1921 the Parker's met Willi Knoll; a German fighter pilot. His revolutionary ideas to modernize comfort transformed the business. The coiled wire spring system, developed to redefine comfort, remains unchanged in many of our chairs today.

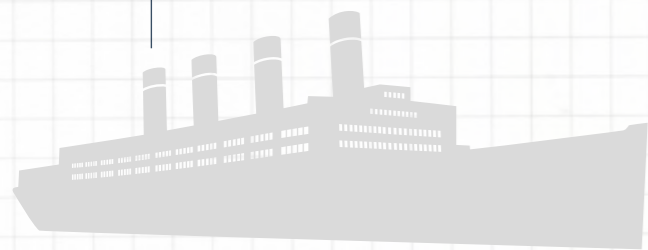

## 1914

### The War Effort

As demand continued to grow the Parker's began manufacturing furniture for Victorian gentry, which later led to furnishing the Palladian lounge of RMS Aquitania during the first world war.

## 1936

### Furnishing the BBC

In the 1930s Parker Knoll chairs were chosen to furnish most of the new BBC headquarters broadcasting house at Portland Place. In 1936, King Edward VIII presented his Empire Day Speech at the BBC sitting in a Parker Knoll chair.

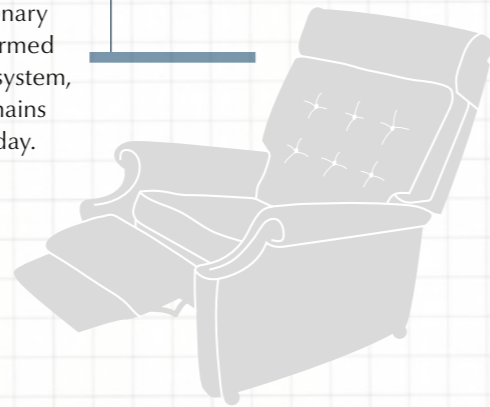

## 1960

### The Swinging 60s

For Parker Knoll the late 1960s were very definitive. The development of motion furniture began alongside iconic designs such as the Merrywood Collection and The Norton Group.

## 2016

### Castlewood, Nottinghamshire

With 147 years of knowledge and expertise, the Parker Knoll brand continues to grow. In 2016 the brand moved to a new purpose built state of the art manufacturing facility in Castlewood, Nottinghamshire. Parker Knoll's new home will help facilitate the brand's evolution in line with continuing to design and develop the best of British Sofas and Chairs that provide the ultimate in comfort.



## 1996

### Number 1 Furniture Brand

Parker Knoll is named The Number 1 Furniture Brand in the UK



## 1969

### The Statesman

With its deep buttoned back and swivel pedestal base, the Statesman Chair was an instant hit during the 60s and 70s, quickly becoming a best seller and a modern status symbol.



## 2015

### Maison

Parker Knoll relaunches the Maison Collection. This new range is targeted at a younger more style-driven consumer.

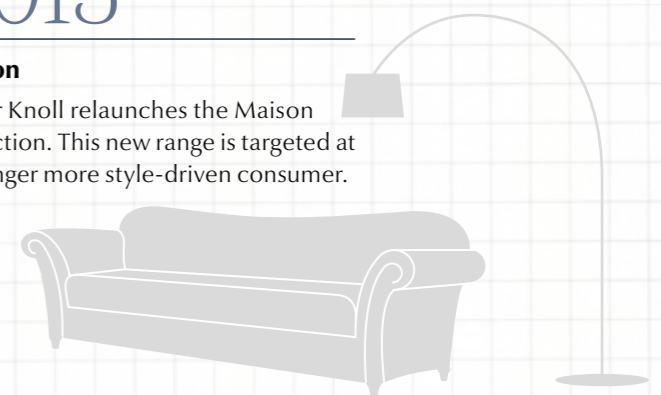

CELEBRATING  
**150** years  
OF PARKER KNOLL

## 2019

### Celebrating 150 years of Parker Knoll

At Parker Knoll we have been expertly handcrafting the finest sofas and chairs since 1869. Our 150th year was celebrated with a new collection launch that pays homage to our past whilst embracing the future.

## 2017

### evolution

As Parker Knoll continues to seek new ways to redefine comfort whilst launching stylish collections of the highest possible quality, the contemporary collection, evolution, is launched.

evolution



## The Fabric Collection

At Parker Knoll we have always understood the importance of elegant and luxurious fabric ranges, to help you create your suite of distinction. We are therefore delighted to present our latest collection.

Our extensive fabric collection includes classic designs, stripes and plains that are a delight to touch. Whether your preference is for classic damasks, deep and rich velvets, or the softest of chenilles, there is a world of choice to help you create the perfect suite for your home.

Our design team have created a fabulous range of luxury fabrics and leathers that have been chosen on your behalf to work perfectly with our stylish furniture range. Our leathers are sourced from the best tanneries worldwide, and offer the finest of quality that look fabulous, feel soft and offer their own distinctive finish and natural characteristics.

The criteria for selection are strict - we choose our fabrics for their beautiful design, enduring quality and ultimate comfort. The entire collection is selected and tested to meet the exacting quality standards that you would expect from Parker Knoll, ensuring that your furniture will continue to delight you for years to come.

It's little wonder we've been famous for fabulous furniture since 1869.



# Crypton by Parker Knoll



Superior stain repellency makes cleaning easy

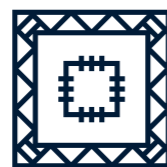

Soft, beautiful and perfectly suited for everyday living

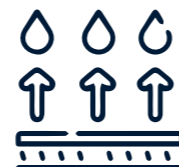

Releases both oil and water-based stains

Crypton fabrics can withstand up to anything that life throws at them. With superior stain, spill and odour resistance and permanent performance, this new collection of fabrics will give you the freedom to create a home that will stand the test of time, every time.

The new Crypton collection is a collaboration that celebrates the latest innovative techniques and creative thinking. The result? Intelligent fabrics for modern living. Together we believe that you don't have to sacrifice soft and luxurious product for the sake of performance.

Over our 150th year we have partnered with the best and Crypton is no different. For more than 25 years, Crypton have pioneered the fabric industry with innovation being the key to their success, much like Parker Knoll.



- Easycare finish
- Protection sealed into every fibre
- Practical and sustainable
- Odour resistant

We are very proud to introduce our new collection of fabrics; Crypton. Intelligent fabrics for modern living.

**Parker Knoll**  
CRYPTON.

# Dakota

The Dakota boasts a modern aesthetic and an abundance of style. Sophisticated and subtle, this collection will effortlessly complement any contemporary living space. Available with the option of a powered recline with a USB port to charge all your favourite devices.

Dakota is now available with a Rise and Recline chair.







# Manhattan

Manhattan offers a more casual approach to motion furniture with clean sweeping lines and a smooth reclining mechanism. Choose from a power recliner with a neat USB port, or a static sofa or chair for the ultimate comfort experience.





# Colorado

A contemporary suite that combines comfort and style. With curved, clean lines and a three tiered cushioned back, this contemporary classic is the perfect addition to any home. Available with the option of a powered recline with a neat USB port for charging your favourite devices.





# Hudson

With its deep and curvaceous rounded back, Hudson is designed to cradle your body and offer the ultimate in comfort. Choose a subtle colourway paired with stylish scatter cushions to make your new sofa a statement piece.





# Boston

Boston's unique tailoring and inset piping detail, make it the perfect addition to any home.

Featuring a stylish brushed steel USB port on power recliner models, as well as a contemporary Large Two Seater option, Boston provides the ultimate relaxation.

AVAILABLE AT SELECTED STOCKISTS

AVAILABLE AT SELECTED STOCKISTS





AVAILABLE AT SELECTED STOCKISTS



AVAILABLE AT SELECTED STOCKISTS

# Hampton

Ergonomically designed and contemporary in style, Hampton provides sumptuous comfort thanks to the expertly engineered lumbar support in the back cushion, deep seats and smooth reclining mechanism.



AVAILABLE AT SELECTED STOCKISTS

AVAILABLE AT SELECTED STOCKISTS



AVAILABLE AT SELECTED STOCKISTS

AVAILABLE AT SELECTED STOCKISTS

# Michigan

With clean, curved lines and compact proportions, Michigan offers a contemporary look that is designed to suit any home. Michigan's three tiered back cushion and high back offer the ultimate in comfort and support.



AVAILABLE AT SELECTED STOCKISTS

AVAILABLE AT SELECTED STOCKISTS

# Norton 150

Find your true comfort position with Norton 150. A reinvention of a 1960s Classic, refined for your home using our 150 years of experience. Norton 150 offers a smooth electric reclining system designed to give you ultimate comfort. Choose a Norton 150+ for our innovative adjustable headrest.



# Comfort in Motion

Since the Parker Knoll story began back in 1869, our goal has been simple - to innovate in design and technology, to seek out the best products available to provide unparalleled comfort and timeless design.

Our Comfort in Motion collection brings you the very best in motion technology developed to provide you with stylish contemporary furniture for everyday use.

Our Dakota, Boston, Hudson and Norton ranges have been designed with a deep curvaceous back and are fitted with our motion technology which will smoothly take you from fully reclined all the way to standing with its easy-to-use handset.

## Hudson Rise & Recline



ZERO  
RATED  
VAT

## Norton 150 Rise & Recline



ZERO  
RATED  
VAT

# Model Specification

## Boston, Dakota, Hudson and Michigan Rise & Recline

## Norton 150 Rise & Recline



### Features:

- Dual motor for independent footrest and back operation
- Spring loaded footrest
- Two large pockets with option of left and right hand operating handset
- Battery back up
- Easy to use quick release handset with reset function

### Features:

- Three motor system for independent footrest, headrest and back operation
- Memory functionality allowing you to save and easily access your favourite positions
- Two large pockets with the option of a left or right hand operating handset



All lifting chairs are suitable for users up to 21 stone



Choose from a range of fabrics and leathers



5 Year guarantee on motors and mechanisms

## Dakota



**SINGLE STATIC ARM END**  
Left Hand Facing or Right Hand Facing  
H103cm W72cm D95cm  
SH51cm SW56cm SD52cm AH65cm

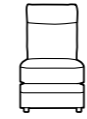

**CENTRE UNIT**  
H103cm W56cm D95cm  
SH51cm SW56cm SD52cm

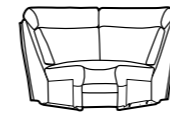

**CORNER UNIT**  
H103cm W165cm D107m  
SH51cm SW95cm SD58cm



**SINGLE POWER RECLINER ARM END**  
Left Hand Facing or Right Hand Facing  
H103cm W72cm D95cm  
SH51cm SW56cm SD52cm AH65cm  
Full Recline 165cm



**RISE & RECLINE CHAIR**  
H106cm W89cm D95cm  
SH53cm SW54cm SD52cm AH67cm  
Full Recline 162cm



OPTIONS*	STANDARD	OPTION
FEET	GLIDE	CASTORS
FEET OPTION NOT AVAILABLE ON RECLINER UNITS		
AVAILABLE IN LEATHER OR FABRIC		

KEY TO MEASUREMENTS	
H	Total Height
W	Total Width
D	Total Depth
SH	Seat Height
SW	Seat Width
SD	Seat Depth
AH	Arm Height

## Dakota



**CHAIR**  
H103cm W91cm D95cm  
SH51cm SW56cm SD52cm AH65cm

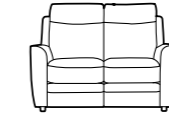

**TWO SEATER SOFA**  
H103cm W142cm D95cm  
SH51cm SW107cm SD52cm AH65cm

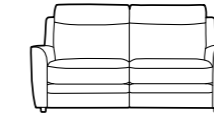

**LARGE TWO SEATER SOFA**  
H103cm W193cm D95cm  
SH51cm SW158cm SD52cm AH65cm



**POWER RECLINER CHAIR**  
H103cm W91cm D103cm  
SH51cm SW56cm SD52cm AH65cm  
Full Recline 165cm



**TWO SEATER POWER RECLINER SOFA**  
H103cm W142cm D86cm  
SH51cm SW107cm SD52cm AH65cm  
Full Recline 165cm

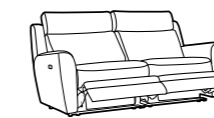

**LARGE TWO SEATER POWER RECLINER SOFA**  
H103cm W193cm D95cm  
SH51cm SW158cm SD52cm AH65cm  
Full Recline 160cm

OPTIONS*	STANDARD	OPTION
FEET	GLIDE	CASTORS
FEET OPTION NOT AVAILABLE ON RECLINER UNITS		
AVAILABLE IN LEATHER OR FABRIC		

## Manhattan



**CHAIR**  
H100cm W98cm D98cm  
SH51cm SW54cm SD54cm AH62cm

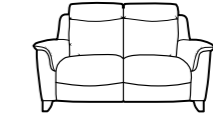

**TWO SEATER SOFA**  
H100cm W162cm D98cm  
SH51cm SW117cm SD54cm AH62cm

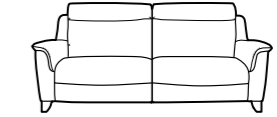

**LARGE TWO SEATER SOFA**  
H100cm W200cm D98cm  
SH51cm SW154cm SD54cm AH62cm

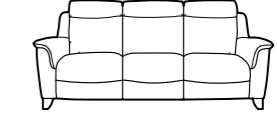

**THREE SEATER SOFA**  
H100cm W207cm D98cm  
SH51cm SW162cm SD54cm AH62cm

OPTIONS*	STANDARD	OPTION
WOOD FINISH	MAHOGANY	TEAK
AVAILABLE IN LEATHER OR FABRIC		

# Manhattan



**POWER RECLINER CHAIR**  
H100cm W98cm D98cm  
SH51cm SW54cm SD54cm AH62cm  
Full Recline 158cm

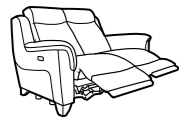

**TWO SEATER POWER RECLINER SOFA**  
H100cm W162cm D98cm  
SH51cm SW117cm SD54cm AH62cm  
Full Recline 158cm

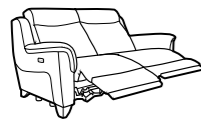

**LARGE TWO SEATER POWER RECLINER SOFA**  
H100cm W200cm D98cm  
SH51cm SW154cm SD54cm AH62cm  
Full Recline 158cm

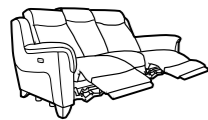

**THREE SEATER POWER RECLINER SOFA**  
H100cm W207cm D98cm  
SH51cm SW162cm SD54cm AH62cm  
Full Recline 158cm

# Colorado



**SMALL CHAIR**  
H105cm W99cm D91cm  
SH52cm SW51cm SD57cm AH65cm



**CHAIR**  
H105cm W107cm D91cm  
SH52cm SW59cm SD57cm AH65cm

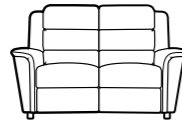

**TWO SEATER SOFA**  
H105cm W158cm D91cm  
SH52cm SW111cm SD57cm AH65cm

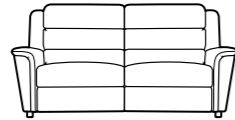

**LARGE TWO SEATER SOFA**  
H105cm W208cm D91cm  
SH52cm SW161cm SD57cm AH65cm

# Colorado



**SMALL CHAIR POWER RECLINER**  
H105cm W99cm D91cm  
SH52cm SW51cm SD57cm AH65cm  
Full Recline 166cm



**CHAIR POWER RECLINER**  
H105cm W107cm D91cm  
SH52cm SW59cm SD57cm AH65cm  
Full Recline 166cm



**TWO SEATER POWER RECLINER SOFA**  
H105cm W158cm D91cm  
SH52cm SW111cm SD57cm AH65cm  
Full Recline 166cm

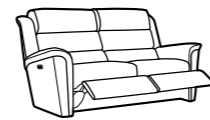

**LARGE TWO SEATER POWER RECLINER SOFA**  
H105cm W208cm D91cm  
SH52cm SW161cm SD57cm AH65cm  
Full Recline 166cm

# Hudson

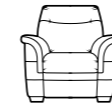

**CHAIR**  
H100cm W97cm D100cm  
SH49cm SW48cm SD53cm AH64cm

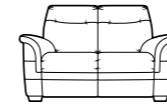

**TWO SEATER SOFA**  
H100cm W155cm D100cm  
SH49cm SW106cm SD53cm AH64cm

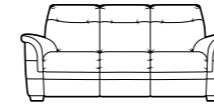

**THREE SEATER SOFA**  
H100cm W208cm D100cm  
SH49cm SW159cm SD53cm AH64cm



**RISE & RECLINE CHAIR**  
H101cm W90cm D96cm  
SH51cm SW47cm SD53cm AH66cm  
Full Rise 137cm  
Full Recline 165cm



**CHAIR RECLINER**  
Available in Manual and Power options  
H100cm W97cm D100cm  
SH49cm SW48cm SD53cm AH64cm  
Full Recline 166cm



**TWO SEATER RECLINER SOFA**  
Available in Manual and Power options  
H100cm W155cm D100cm  
SH49cm SW106cm SD53cm AH64cm  
Full Recline 166cm



**THREE SEATER RECLINER SOFA**  
Available in Manual and Power options  
H100cm W207cm D100cm  
SH49cm SW159cm SD53cm AH64cm  
Full Recline 166cm

# Boston

AVAILABLE AT SELECTED STOCKISTS



**CHAIR**  
H100cm W89cm D100cm  
SH50cm SW44cm SD53cm AH65cm



**TWO SEATER SOFA**  
H100cm W140cm D100cm  
SH50cm SW95cm SD53cm AH65cm

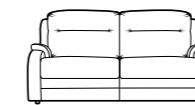

**LARGE TWO SEATER SOFA**  
H100cm W192cm D100cm  
SH50cm SW147cm SD53cm AH65cm

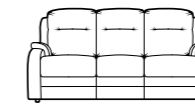

**THREE SEATER SOFA**  
H100cm W192cm D100cm  
SH50cm SW147cm SD53cm AH65cm

# Boston

AVAILABLE AT SELECTED STOCKISTS



**CHAIR RECLINER**  
Available in Manual and Power options  
H100cm W89cm D100cm  
SH50cm SW44cm SD53cm AH65cm  
Full Recline 164cm



**TWO SEATER RECLINER SOFA**  
Available in Manual and Power options  
H100cm W140cm D100cm  
SH50cm SW95cm SD53cm AH65cm  
Full Recline 164cm



**LARGE TWO SEATER RECLINER SOFA**  
Available in Manual and Power options  
H100cm W192cm D100cm  
SH50cm SW147cm SD53cm AH65cm  
Full Recline 164cm



**THREE SEATER RECLINER SOFA**  
Available in Manual and Power options  
H100cm W192cm D100cm  
SH50cm SW147cm SD53cm AH65cm  
Full Recline 164cm



**RISE & RECLINE CHAIR**  
H102cm W87cm D100cm  
SH50cm SW44cm SD53cm AH65cm  
Full Recline 163cm

OPTIONS*	STANDARD	OPTION
WOOD FINISH	MAHOGANY	TEAK
AVAILABLE IN LEATHER OR FABRIC		
AVAILABLE WITH CORDLESS POWER		

OPTIONS*	STANDARD	OPTION
FEET (STATIC MODEL ONLY)	GLIDE	CASTORS
AVAILABLE IN LEATHER OR FABRIC		

OPTIONS*	STANDARD	OPTION
FEET (STATIC MODEL ONLY)	GLIDE	CASTORS
AVAILABLE IN LEATHER OR FABRIC		

OPTIONS*	STANDARD	OPTION
WOOD FINISH (STATIC MODEL ONLY)	TEAK	MAHOGANY
AVAILABLE IN LEATHER OR FABRIC		

OPTIONS*	STANDARD	OPTION
FEET (STATIC MODEL ONLY)	GLIDE	CASTORS
AVAILABLE IN LEATHER OR FABRIC		

OPTIONS*	STANDARD	OPTION
FEET (STATIC MODEL ONLY)	GLIDE	CASTORS
AVAILABLE IN LEATHER OR FABRIC		



# Hampton

AVAILABLE AT SELECTED STOCKISTS



**CHAIR**  
H101cm W96cm D97cm  
SH50cm SW49cm SD55cm AH64cm

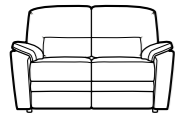

**TWO SEATER SOFA**  
H101cm W148cm D97cm  
SH50cm SW98cm SD55cm AH64cm

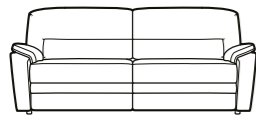

**LARGE TWO SEATER SOFA**  
H101cm W198cm D97cm  
SH50cm SW150cm SD55cm AH64cm



**CHAIR RECLINER**  
Available in Manual and Power options  
H101cm W96cm D97cm  
SH50cm SW49cm SD55cm AH64cm  
Full Recline 140cm

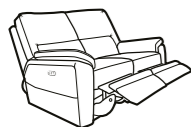

**TWO SEATER RECLINER SOFA**  
Available in Manual and Power options  
H101cm W148cm D97cm  
SH50cm SW98cm SD55cm AH64cm  
Full Recline 140cm



**LARGE TWO SEATER RECLINER SOFA**  
Available in Manual and Power options  
H101cm W198cm D97cm  
SH50cm SW150cm SD55cm AH64cm  
Full Recline 140cm

OPTIONS*	STANDARD	OPTION
FEET (STATIC MODEL ONLY)	GLIDE	CASTORS
AVAILABLE IN LEATHER OR FABRIC		

# Michigan

AVAILABLE AT SELECTED STOCKISTS



**CHAIR**  
H103cm W95cm D99cm  
SH50cm SW45cm SD55cm AH65cm

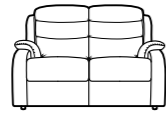

**TWO SEATER SOFA**  
H103cm W144cm D99cm  
SH50cm SW95cm SD55cm AH65cm

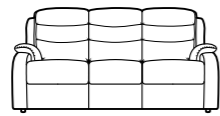

**THREE SEATER SOFA**  
H103cm W196cm D99cm  
SH50cm SW146cm SD55cm AH65cm



**CHAIR RECLINER**  
Available in Manual and Power options  
H103cm W95cm D99cm  
SH50cm SW45cm SD55cm AH65cm  
Full Recline 167cm



**TWO SEATER RECLINER SOFA**  
Available in Manual and Power options  
H103cm W147cm D99cm  
SH50cm SW95cm SD55cm AH65cm  
Full Recline 167cm

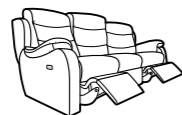

**THREE SEATER RECLINER SOFA**  
Available in Manual and Power options  
H103cm W199cm D99cm  
SH50cm SW146cm SD55cm AH65cm  
Full Recline 167cm



**RISE & RECLINE CHAIR**  
H104cm W87cm D95cm  
SH50cm SW45cm SD55cm AH65cm  
Full Recline 167cm

OPTIONS*	STANDARD	OPTION
FEET (STATIC MODEL ONLY)	GLIDE	CASTORS
AVAILABLE IN LEATHER OR FABRIC		

# Norton 150



**CHAIR 150+**  
MOTION HEADREST  
H103cm W92cm D88cm  
SH49cm SW53cm SD55cm AH60cm  
Full Recline 162cm



**RISE & RECLINE CHAIR**  
MOTION HEADREST  
H103cm W92cm D88cm  
SH49cm SW53cm SD55cm AH60cm  
Full Rise 143cm Full Recline 162cm



OPTIONS*	STANDARD	OPTION
WOOD FINISH	MAHOGANY	CHERRY TEAK LIGHT OAK
AVAILABLE IN LEATHER OR FABRIC		

# Footstools

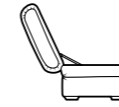

**LIFESTYLE STORAGE FOOTSTOOL**  
H48cm W75cm D60cm

OPTIONS*	STANDARD	OPTION
WOOD FINISH	MAHOGANY	TEAK
AVAILABLE IN LEATHER OR FABRIC		



**SMALL STORAGE FOOTSTOOL**  
H38-46cm\*\* W70cm D62cm

OPTIONS*	STANDARD	OPTION
WOOD FINISH	MAHOGANY	CHERRY TEAK WALNUT WASHED OAK BRUSHED STEEL
LEG TRIM	SHROUD	MANHATTAN EVOLUTION

NOTE: NOT ALL WOOD FINISHES ARE AVAILABLE WITH EVERY LEG TRIM

\*\*HEIGHT DEPENDENT ON CHOSEN LEG

AVAILABLE IN LEATHER OR FABRIC



**LARGE STORAGE FOOTSTOOL**  
H38cm W89cm D62cm

OPTIONS*	STANDARD	OPTION
WOOD FINISH	MAHOGANY	TEAK
AVAILABLE IN LEATHER OR FABRIC		

# Visit our Showroom

Located in the heart of Long Eaton, our 3000 sq ft showroom contains a wide range of furniture from the Parker Knoll collection and is **available by appointment** for customers to visit, only 3 miles from Junction 25 of the M1 in Nottinghamshire.

We have a range of appointment options available to suit your every need. Face to face, telephone, zoom and virtual tours are all available. Visit [www.parkerknoll.co.uk/showroom](http://www.parkerknoll.co.uk/showroom) or email [parkerknollshowroom@parkerknoll.co.uk](mailto:parkerknollshowroom@parkerknoll.co.uk) to book your free consultation today.



**Parker Knoll Showroom,**  
Turret C, 3rd Floor  
Harrington Mills, Leopold Street,  
Long Eaton, Nottingham, NG10 4QE  
Monday - Friday, 10am - 4pm

# Additional Information

## Options\*

All options are available at no additional charge. PLEASE STATE YOUR CHOICE CLEARLY WHEN ORDERING. Your order will be supplied with the standard finish unless you state the option.

## Wood Finishes

Wood colour options can vary for each model in the range, please see the options below each model in the model specification or ask in store for further details.



Mahogany Cherry\*\* Teak Light Oak\*\*\*

\*\* Cherry is available on Norton only

\*\*\* Light Oak is available on Norton only

## 25 Year Guarantee

With over 150 years' of furniture making experience, at Parker Knoll we are experts in designing and developing the best of British Sofas and Chairs. That's why all our furniture is supported by a 25 year frame and frame assembly guarantee — ensuring that you can find comfort in choosing Parker Knoll.



## Zero Rated Vat



Available on Boston, Dakota, Hudson and Norton Rise & Recline. You will need to provide relevant documentation at point of purchase in order to qualify.

## Recliner Furniture

Our recliner furniture is developed to require minimal space to recline in order to enhance the space in your room. We do advise that you leave 150mm for all of our recliners, except the Norton which requires 510mm, to ensure your furniture can recline smoothly.

All Reclining Sofas are delivered into the home as sectional units.

## Cordless Power

We recommend that you charge your cordless power Manhattan every two to five days, overnight for eight hours to ensure the best usage.

## Fabrics

All Parker Knoll fabrics are available as cut lengths and can be supplied to the nearest half metre. When ordering, please state the fabric and colour reference clearly. Leather is not available as a cut length.

Some fabrics in the collection may only be available to order on scatter cushions, chairs and other accent pieces, please refer to the swatch books in store for further information.

## Easycare Fabrics

Our new range of fabrics have been specially selected to ensure they can be easily cared for in your home.

With yarns that are extra durable and inherently stain resistant, this range of eco-friendly fabrics have a super soft handle that will enhance the comfort of your sofa. Please refer to our fabric swatch books in store for further information.

## Fabric Combinations

The sofas in this collection are offered in a single combination finish.

The Montana Two Seater and Large Two Seater Sofas are available with scatters in a second fabric. Please state your choice clearly when ordering.

## Fabric Samples

Fabric samples are available on request from our website; we endeavour to deliver within 2-3 working days.

## Railroaded Fabrics

Please note that railroaded fabrics are not suitable for curtains; please refer to the swatch books in store for further information.

## Sofa Buying Guide

Are you still unsure about the right sofa for you? Our handy, online sofa buying guide will steer you in the right direction. It covers everything from selecting the proper size, fabric, style and interior. We recommend referring to our guide for further advice to ensure you create your perfect sofa.

## Choosing Fabrics

When choosing a Parker Knoll fabric, it is advisable to think about the environmental and lifestyle factors that may impact upon fabric behaviour.

We recommend that you do not expose your upholstery to long periods of direct sunlight, as this may result in fading. Close and constant exposure to heat can also influence colouration so it is important to consider where in the room your sofa will be placed when choosing fabric.

It is also key to consider the fabric type and its associated behaviours and characteristics. A fabric with a pile direction such as chenilles or velvets may naturally flatten and be influenced by pressure or shade as the fibres change.

Appropriate care of your upholstery will ensure your velvet or chenille furniture looks fabulous and stands the test of time.

All of the fabrics within the Parker Knoll fabric collection are tested for use in a domestic environment.

You will find information regarding the fabric composition on the label on your samples or on the back of each swatch in our in store sample books.

If you have any questions or queries regarding your chosen fabrics please visit a Parker Knoll retailer or contact our customer support team who will be happy to assist you. For more information visit [www.parkerknoll.co.uk](http://www.parkerknoll.co.uk).

## Choosing Leather

It is important to understand the characteristics of leather when choosing to purchase this type of sofa. Leather suites are classic and timeless; the high quality, natural and hard wearing leathers we offer look great and are really easy to care for.

It is key to note that leather will move over time, and may display traces of the past such as healed scars, insect bites, growth marks and veins. These are all hallmarks of hide and in no way detract from the wearing qualities of leather.

## Pattern Repeats and Widths

Please refer to the swatch books in store for further information.

## Accessories

**Please Note: Some of our images are shown with scatters to enhance the look. Please check the model specification for details on which models include scatters, as per the line drawing.**

Scatter cushions are available as chargeable extras on all models. The Montana Large & Two Seater Sofas come with two standard fibre filled self-sewn scatter cushions. Cushion interiors are also available with a choice of feather filling. Cushions can be made in any fabric within the Parker Knoll collection. Scatter cushions in Classic fabrics come self-piped.

## BSI ISO 9001

Parker Knoll Upholstery is proud to have been awarded the BSI ISO 9001 QMS certificate. This is your assurance that we at Parker Knoll comply with stringent quality standards. Our products are regularly subjected to independent testing to ensure safety, product performance and reliability. The ISO 9001 QMS at Parker Knoll is continually assessed demonstrating our commitment to continual improvement, customer satisfaction and always maintaining the highest possible standards.



## Crypton by Parker Knoll

Crypton fabrics can withstand up to anything life throws at it. With superior stain, spill and odour resistance and permanent performance this collection of fabrics will give you the freedom to create a home that will stand the test of time, every time, without compromise. For more information or to experience the full collection find your nearest stockist at [www.parkerknoll.co.uk](http://www.parkerknoll.co.uk)



Every Parker Knoll piece is handcrafted to order in our state-of-the-art factory in rural Nottinghamshire. Our founders commitment is still at the heart of everything that we do: to produce beautiful, high-quality designs with the utmost style.

We have tried to be as accurate as possible in the presentation of information. However, some dimensions shown should be regarded as approximate only, due to the nature of upholstery fabrics used.

Parker Knoll has a policy of continual development and improvement, and therefore advises that current specifications should be checked prior to ordering.

Parker Knoll reserve the right to alter specifications and to discontinue models and fabrics without notice.

Due to varying lighting conditions during photography and limitations in digital and printing technology, colours in this catalogue may vary from actual materials. Furthermore, sofa images have been altered to enhance their natural beauty.

Some cushions, rugs and accessories shown in the brochure are not manufactured by Parker Knoll. Some fabrics may not be available on selected models. Please ask in store for further details.



# Parker Knoll

## Parker Knoll Head Office

Parker Knoll Upholstery Limited,  
Castlewood Business Park,  
Farmwell Lane, Sutton in Ashfield,  
Nottinghamshire NG17 1BX  
Postcode for Sat Nav: NG17 1JF

Tel 01773 604 121 Fax 01773 540 084

Email [customer.support@parkerknoll.co.uk](mailto:customer.support@parkerknoll.co.uk)  
[www.parkerknoll.co.uk](http://www.parkerknoll.co.uk)

A Sofa Brands International Company  
All images are copyrighted © 2005-2023 Parker Knoll.  
February 2023/1st Edition 138

## Parker Knoll Showroom

Turret C, 3rd Floor,  
Harrington Mills,  
Leopold Street, Long Eaton  
Nottinghamshire, NG10 4QE

To book an appointment visit  
[www.parkerknoll.co.uk/showroom](http://www.parkerknoll.co.uk/showroom)  
or call us on 01773 604 121 or email  
[showroom@parkerknoll.co.uk](mailto:showroom@parkerknoll.co.uk)

Photography: [laurence-dutton.com](http://laurence-dutton.com),  
[benanders.co.uk](http://benanders.co.uk), [jondayphotography.com](http://jondayphotography.com)

 [facebook.com/ParkerKnollUpholsteryLtd](https://facebook.com/ParkerKnollUpholsteryLtd)

 [twitter.com/\\_ParkerKnoll](https://twitter.com/_ParkerKnoll)

 [pinterest.com/ParkerKnoll](https://pinterest.com/ParkerKnoll)

 [instagram.com/parkerknoll](https://instagram.com/parkerknoll)

