



User Manual

Version 1.0.0 Jan 2021

RPS-4M

4-slot Industrial Redundant Power Supply



Warranty

All products manufactured by ICP DAS are under warranty regarding defective materials for a period of one year, beginning from the date of delivery to the original purchaser.

Warning!

ICP DAS assumes no liability for any damage resulting from the use of this product. ICP DAS reserves the right to change this manual at any time without notice. The information furnished by ICP DAS is believed to be accurate and reliable. However, no responsibility is assumed by ICP DAS for its use, nor for any infringements of patents or other rights of third parties resulting from its use.

Copyright

Copyright © 2020 ICP DAS Co., Ltd. All rights are reserved.

Trademarks

Names are used for identification purposes only and may be registered trademarks of their respective companies.

Contents

1. Introduction	4
2. Specifications	6
2.1. Hardware Specifications	6
2.2. System Specifications	8
2.3. Pin Assignments	10
2.4. DIP Switch Configuration	12
2.4.1. Normal Mode	13
2.4.2. Initial Mode	13
2.4.3. Hardware Mode	13
2.5. Software Configuration Tables	15
3. Modbus TCP/RTU Protocol	16
3.1. Modbus Address Mapping	17
3.2. Function 01 - Read Coils	20
3.3. Function 02 - Read Discrete Inputs	21
3.4. Function 03 - Read Multiple Registers	22
3.5. Function 04 - Read Multiple Input Registers	23
3.6. Function 05 – Write Single Coil	24
3.7. Function 06 – Write Single Register	25
3.8. Function 15 – Write Multiple Coils	26
3.9. Function 16 – Write Multiple Registers	27
3.10. Function 112 – Read/Write Module Setting	28
3.10.1. Sub-function 00 – Write time to RTC	29
4. Web Setting	30
4.1. Configuring Network Settings	30
4.2. Home Page	31
4.3. Port Page	33
4.4. Network Page	34
4.5. Filter Page	37
4.6. Monitor Page	38
4.7. Password Page	39
4.8. Logout Page	40
5. Appendix A	41
5.1. Firmware update	41

1. Introduction

In response to the requirements of lots of digital DC power supplies in the industry, ICP DAS has developed the RPS series of redundant power supply, which not only adopts the N+1 parallel-connection and load-sharing technology to implement power redundancy, but also adds communication functions to enable that information of power supply can be monitored in real time. Through the communication functions, user can monitor the working status of the power supply of the whole factory in the monitoring center. When the power module is abnormal, it can be found and dealt with in real time. There is no need to send people to inspect and ensure that the power supply is safe. In particular, the equipment in some important industries such as finance, medical treatment and power plants needs stable power supplies to ensure that the equipment keeps working.

The RPS-4M has built-in Ethernet and RS-485 communication interfaces, which can not only monitor the operation status of the power modules in real time, but also instantly return various real-time information of the power modules, including load current, temperature, existence of the power module in the slots, malfunction of the power module, etc. The information not only can be used to evaluate the health condition of the power module itself, but also can be record to estimate the power consumption of the whole system, and an instant warning can be sent when abnormal power consumption occurs. Through the information, user can easily implement predictive alarm and fault alarm function for the system. In addition, the RPS-4M can also record the using time of each power module, which can be used as a basis for maintenance and replacement and estimate MTBF (Mean Time Between Failures). When the power module has reached the recommended service life, user can replace it early to make the power system more reliable and stable. The RPS-4M has a built-in load balancing function, so there is no need to add extra load balancing modules. In addition, the RPS-4M adopts a slot-type design, and it supplies hot swapping function, so when user replaces the power module, there is no need to turn off the power system. In comparison to the traditional power supply, the RPS-4M saves the trouble of wiring, and it is simpler and safer.

Features

- Max 400W output power, each slot can insert a 100W power module
- N+1 Redundant, maximum N=3
- Power module supports hot swapping
- Detect current load of module
- Detect temperature of module
- Easy installation.
- Support Modbus RTU/TCP Protocol.

2. Specifications

2.1. Hardware Specifications

Electrical Specification		
Output	DC Voltage	24V
	Rated Current	4.16A
	Current Range	0~4.16A
	Rated Power	100W
	Ripple & Noise(max.)	50mVp-p
	Voltage adj. Range	23~25V
	Voltage Tolerance	±1.0%
	Line Regulation	±1.0%
	Load Regulation	±3.0%
	Setup, Rise Time	1300ms,120ms at full load
	Hold Up Time(Typ.)	40ms at full load
Input	Voltage Range	90~264VAC
	Frequency Range	47 ~ 63Hz
	Power Factor(Typ.)	PF=0.961/230VAC at full load, PF=0.985/115VAC at full load
	Efficiency(Typ.)	86%
	AC Current(Type)	1.01A/115VAC 0.51A/230VAC
	Inrush Current	COLD START 30A/115VAC 60A/230VAC
	Leakage Current	Earth<3.5mA ,Touch<0.25mA
Protection	Overload	110%~200% (Automatic recovery)
	Over Voltage	26.4~31.2 (Automatic recovery)
Environment	Working Temperature	-20~50°C
	Working Humidity	5~95%RH Non-condensing.
	Storage Temperature, Humidity	-40~85°C
	Vibration	0.26~6.09 G Frequency Type: Sweep Frequency Frequency Range: 10~55 Hz Displacement: 1.0mm Sweep Rate: 60 minute / cycle

		Number of cycle: 1 cycle / axis Direction: X ,Y and Z axis
Safety & EMC	Safety Standards	Design to meet 62368
	Withstand Voltage	I/P-O/P:3KVAC I/P-FG:1.8KVAC O/P-FG:0.5KVAC
	Isolation Resistance	I/P-O/P, I/P-FG, O/P-FG:>100M Ohms / 500VDC
	EMC Emission	EN 55032 CISPR 32 & FCC Part 15 B CLASS B : System with 4 module in parallel
	EMC Immunity	EN 55022, CISPR 22 & FCC Part 15, EN 61000-3-2, EN 61000-3-3, EN 61204-3 IEC 61000-4-2, IEC 61000-4-3, IEC 61000-4-4, IEC 61000-4-5, IEC 61000-4-6, IEC 61000-4-8, IEC 61000-4-11

Note: This hardware specification is only for one RPS-M100W power module.
RPS-4M can insert Max. 4 RPS-M100W power module.

2.2. System Specifications

COM Port		
Interface	RS-485	
Protocol	Modbus RTU	
Data Format	N,8,1 / O,8,1 / E,8,1 / N,8,2	
Baud Rate	Hardware Configuration: Fixed 9600 bps	
	Software Configuration: 1200 ~ 115200 bps	
Node Address	1 ~ 64 for hardware configuration 1 ~ 255 for software configuration * For Modbus RTU, address 0 is auto become to 1	
Connector	4-pin screw terminal	
Ethernet		
Interface	1 x RJ-45, 10/100 Base-TX	
Protocol	Modbus RTU or DCON	
Safety	Password and IP Filter	
Measurement		
Current	Range	0A ~ 5 A
	accuracy	±0.25A
Temperature	Range	0°C ~ 100°C
	accuracy	±5°C
LED Indicators		
Power	1 LED as power indicator	
Communication	1 LED as Modbus Rx indicator	
Status	1 LED as status indicator	
EMS Protection		
ESD (IEC 61000-4-2)	±4 kV Contact, ±4 kV Air	
EFT (IEC 61000-4-4)	±2 kV for power line	
Surge (IEC 61000-4-5)	±2 kV for power line	
Power Requirements		
Input Voltage Range	90~264VAC, 47 ~ 63Hz	
Connector	3-pin screw terminal	
Mechanical		
Dimensions (W x L x H)	133 mm x 266 mm x 177 mm	
Installation	DIN-Rail	
Environment		

Operating Temperature	-20°C ~ +50°C
Storage Temperature	-40°C ~ +85°C
Humidity	10 to 90% RH, Non-condensing

2.3. Pin Assignments



1. DC Output

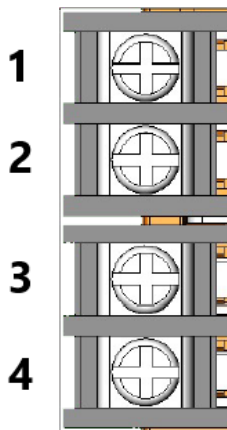

Pin	Description
1	Power output +24 V _{DC}
2	Power output +24 V _{DC}
3	Ground
4	Ground

2. Relay Output

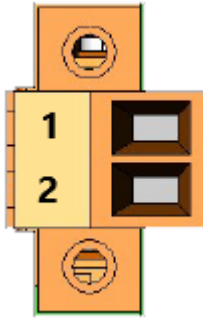

Pin	Description
1	Relay output: NO.
2	Relay output: COM

3. A.C. Power Input

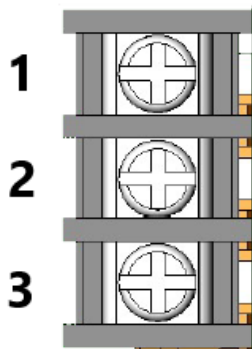

Pin	Description
1	Live Wire (L)
2	Naught wire (N)
3	Earth Wire (G)

4. RS-485 Interface

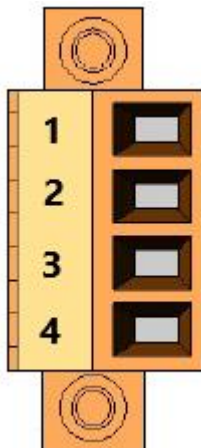

Pin	Description
1	Data+ (D+)
2	Data- (D-)
3	Data+ (D+)
4	Data- (D-)

2.4. DIP Switch Configuration

Configure DIP Switch Description

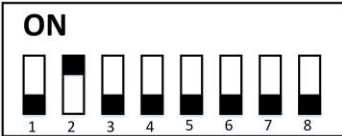
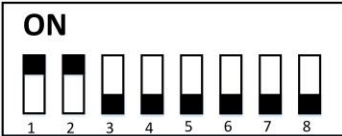
<p>Normal Mode</p>		<p>In this mode, node ID and baud rate depend on the parameters stored in the FRAM. The PWR LED is always on.</p>
<p>Initial Mode</p>		<p>In this mode, node id is 1 and baud rate is 9600bps. User can change node ID and baud rate by modifying Modbus register and these parameters will take effect when the module power on in Normal Mode next time.</p>
<p>Hardware Mode</p>		<p>In this mode, user can use DIP switch pin 3 to pin 8 to set the node ID (1 ~ 64) and the other configuration still depends on the parameters stored in the FRAM.</p>

2.4.1. Normal Mode

When the RPS-4M is powered on and the position of the DIP-Switch 1 and 2 are configured to OFF, the module will be set to Normal Mode. In this mode, the position of DIP switch 3 ~ 8 will be ignored and the configuration parameters to be used will be retrieved from the FRAM. The default configuration parameters stored in the FRAM is:

Protocol:	Modbus RTU/TCP
IP address:	192.168.255.1
Modbus TCP Port:	502
Address:	01
Baud Rate:	9600 bps
Data Format:	N, 8, 1

In this mode, any software command related to configuration will return an error when using the Modbus RTU protocol.

2.4.2. Initial Mode

When the RPS-4M is powered on and the position of the DIP-switches 1 is configured to OFF and 2 is configured to ON, the module will be set to Initial Mode. In this mode, the following configuration parameters are used.

Protocol:	Modbus RTU/TCP
IP address:	192.168.255.1
Modbus TCP Port:	502
Address:	01 (0x01)
Baud Rate:	9600 bps
Data Format:	N,8,1

In this mode, the relevant commands can be used to change the configuration, and the new settings will be saved to the EEPROM.

2.4.3. Hardware Mode

When the RPS-4M is powered on and the position of the DIP-Switch 1 and

2 are configured to ON, the module will be set to Hardware Mode. In this mode, the position of the DIP-Switch 3 to 8 will be used to configure the node ID and the other configuration parameters will be retrieved from the FRAM. The default configuration parameters stored in the EEPROM is:

Protocol:	Modbus RTU/TCP
IP address:	Read from FRAM
Modbus TCP Port:	Read from FRAM
Address:	01 + Pin 3 to 8 of DIP switch (01 to 64)
Baud Rate:	Read from FRAM
Data Format:	Read from FRAM

In this mode, any software command related to configuration will return an error when using the Modbus RTU protocol.

2.5. Software Configuration Tables

Baud Rate Settings

0	1	2	3	4	5	6	7	
Data Rate			Reserved	Data Bit, Parity, Stop Bit			Reserved	

Data Rate (Bit 0 ~ Bit 2)

Code	0	1	2	3	4	5	6	7
Baud	1200	2400	4800	9600	19200	38400	57600	115200

Data Bit, Parity and Stop Bit (Bit 4 ~ Bit 5)

Code	0	1	2	3
Format	8, n, 1	8, n, 2	8, e, 1	8, o, 1

For example, if set configuration 0x37, it means Data rate is 115200 bps, Data bits are 8 bits, Parity is odd and Stop bit is 1 bit.

Note: All Reserved bits should be zero.

3. Modbus TCP/RTU Protocol

The Modbus protocol was originally developed for Modicon controllers by Modicon Inc. Detailed information related to the Modbus RTU protocol can be found at <http://www.modbus.org> for more valuable information.

The RPS-4M module supports the Modbus TCP/RTU protocol, with communication baud rates ranging from 1200 bps to 115200 bps. The data bits, parity and stop bits are supported 8 n 1, 8 n 2, 8 e 1 and 8 o 1. The following Modbus functions are supported.

Function Code	Description	Section
0x01	Read the coils	3.2
0x02	Read the discrete inputs	3.3
0x03	Read multiple registers	3.4
0x04	Read multiple input registers	3.5
0x05	Write a single coil	3.6
0x06	Write a single register	3.7
0x0F	Write multiple coils	3.8
0x10	Write multiple registers	3.9
0x70	Read/Write the module settings	3.10

If the function specified in the message is not supported, then the module responds as below. Note that the address mapping for the Modbus protocol is Base 0.

Error Response

Byte	Description	Length (Byte)	Value
00	Address	1	1 ~ 247
01	Function Code	1	Function Code + 0x80
02	Exception Code	1	02: Register not support 03: Modbus format invalid

Note: If a CRC mismatch occurs, the module will not respond.

3.1. Modbus Address Mapping

Coils

Address		Description	Attribute
00001	10001	Power supply unit 0 exist or not	R
00002	10002	Power supply unit 1 exist or not	R
00003	10003	Power supply unit 2 exist or not	R
00004	10004	Power supply unit 3 exist or not	R
00005	10005	Power supply unit 0 is alive or not	R
00006	10006	Power supply unit 1 is alive or not	R
00007	10007	Power supply unit 2 is alive or not	R
00008	10008	Power supply unit 3 is alive or not	R
00101	10101	Host WDT start bit	R / W
00102	10102	Host WDT fail flag, send a correct Modbus command or clear this register to clear the fail flag.	R / W
00501	10501	Reboot, 1: reboot, 0:	W

Register

Address		Description	Attribute
30001	40001	Power supply unit 0 current load, Unit: 10 mA	R
30002	40002	Power supply unit 1 current load, Unit: 10 mA	R
30003	40003	Power supply unit 2 current load, Unit: 10 mA	R
30004	40004	Power supply unit 3 current load, Unit: 10 mA	R
30005	40005	Power supply unit 0 temperature, Unit: 0.1 °C	R
30006	40006	Power supply unit 1 temperature, Unit: 0.1 °C	R
30007	40007	Power supply unit 2 temperature, Unit: 0.1 °C	R
30008	40008	Power supply unit 3 temperature, Unit: 0.1 °C	R
30011	40011	Power supply unit 0 latest continuous working time, Unit: 1 hour	R
30012	40012	Power supply unit 1 latest continuous working time, Unit: 1 hour	R
30013	40013	Power supply unit 2 latest continuous working time, Unit: 1 hour	R
30014	40014	Power supply unit 3 latest continuous working time, Unit: 1 hour	R

30015	40015	Power supply unit 0 total working time, Unit: 1 hour	R
30016	40016	Power supply unit 1 total working time, Unit: 1 hour	R
30017	40017	Power supply unit 2 total working time, Unit: 1 hour	R
30018	40018	Power supply unit 3 total working time, Unit: 1 hour	R
30021	40021	Power supply unit 0 start date (year)	R
30022	40022	Power supply unit 0 start date (month)	R
30023	40023	Power supply unit 0 start date (day)	R
30024	40024	Power supply unit 0 start date (hour)	R
30025	40025	Power supply unit 0 start date (minute)	R
30026	40026	Power supply unit 0 start date (second)	R
30027	40027	Power supply unit 1 start date (year)	R
30028	40028	Power supply unit 1 start date (month)	R
30029	40029	Power supply unit 1 start date (day)	R
30030	40030	Power supply unit 1 start date (hour)	R
30031	40031	Power supply unit 1 start date (minute)	R
30032	40032	Power supply unit 1 start date (second)	R
30033	40033	Power supply unit 2 start date (year)	R
30034	40034	Power supply unit 2 start date (month)	R
30035	40035	Power supply unit 2 start date (day)	R
30036	40036	Power supply unit 2 start date (hour)	R
30037	40037	Power supply unit 2 start date (minute)	R
30038	40038	Power supply unit 2 start date (second)	R
30039	40039	Power supply unit 3 start date (year)	R
30040	40040	Power supply unit 3 start date (month)	R
30041	40041	Power supply unit 3 start date (day)	R
30042	40042	Power supply unit 3 start date (hour)	R
30043	40043	Power supply unit 3 start date (minute)	R
30044	40044	Power supply unit 3 start date (second)	R
30101	40101	IP0, IP address: IP0. IP1. IP2. IP3	R
30102	40102	IP1	R
30103	40103	IP2	R
30104	40104	IP3	R
30105	40105	MAC0, MAC address:	R

		MAC0. MAC1. MAC2. MAC3. MAC4. MAC5	
30106	40106	MAC1	R
30107	40107	MAC2	R
30108	40108	MAC3	R
30109	40109	MAC4	R
30110	40110	MAC5	R
30201	40201	Current time: Year	R
30202	40202	Current time: Month	R
30203	40203	Current time: Day	R
30204	40204	Current time: Hour	R
30205	40205	Current time: Minute	R
30206	40206	Current time: Second	R
30481	40481	Firmware version(High byte HH), Reading method: HH.LL(Ex: HH=01, LL=00 => 01.00)	R
30482	40482	Firmware version(Low byte LL), Reading method: HH.LL(Ex: HH=01, LL=00 => 01.00)	R
30483	40483	Module name (High word)	R
30484	40484	Module name (Low word)	R
System Configuration			
30501	40501	Node ID (writable only for Initial Mode)	R / W
30502	40502	Baud rate (writable only for Initial Mode)	R / W
30504	40504	Modbus response delay time, unit: 1ms	R / W
30505	40505	Host WDT timeout, unit: 100ms	R / W

Note: The address in the table starts from 1, but in Modbus command it should start from 0.

3.2. Function 01 - Read Coils

This function code is used to read the value at addresses 0xxxx.

Request

Byte	Description	Value
00	Module ID	1 ~ 247
01	Function Code	0x01
02 – 03	Reference Address	Refer to section 3.1 – Address 0xxxx
04 – 05	Bit Count	Number of bit (B) to read

Response

Byte	Description	Value
00	Module ID	1 ~ 247
01	Function Code	0x01
02	Byte Count	Response data byte N = B/7
03 – (N +2)	Bit Value	Response bit data

Error Response

Byte	Description	Value
00	Module ID	1 ~ 247
01	Function Code	0x81
02	Exception Code	Refer to section 3 – Error Response

3.3. Function 02 - Read Discrete Inputs

This function code is used to read the value at addresses 1xxxx.

Request

Byte	Description	Value
00	Module ID	1 ~ 247
01	Function Code	0x02
02 – 03	Reference Address	Refer to section 3.1 – Address 1xxxx
04 – 05	Bit Count	Number of bit (B) to read

Response

Byte	Description	Value
00	Module ID	1 ~ 247
01	Function Code	0x02
02	Byte Count	Response data byte N = B/7
03 – (N +2)	Bit Value	Response bit data

Error Response

Byte	Description	Value
00	Module ID	1 ~ 247
01	Function Code	0x82
02	Exception Code	Refer to section 3 – Error Response

3.4. Function 03 - Read Multiple Registers

This function code is used to read the value at addresses 4xxxx.

Request

Byte	Description	Value
00	Module ID	1 ~ 247
01	Function Code	0x03
02 – 03	Reference Address	Refer to section 3.1 – Address 4xxxx
04 – 05	Word Count	Number of word (W) to read

Response

Byte	Description	Value
00	Module ID	1 ~ 247
01	Function Code	0x03
02	Byte Count	Response data byte N = W*2
03 – (N +2)	Word Value	Response word data

Error Response

Byte	Description	Value
00	Module ID	1 ~ 247
01	Function Code	0x83
02	Exception Code	Refer to section 3 – Error Response

3.5. Function 04 - Read Multiple Input Registers

This function code is used to read the value at addresses 3xxxx.

Request

Byte	Description	Value
00	Module ID	1 ~ 247
01	Function Code	0x04
02 – 03	Reference Address	Refer to section 3.1 – Address 3xxxx
04 – 05	Word Count	Number of word (W) to read

Response

Byte	Description	Value
00	Module ID	1 ~ 247
01	Function Code	0x04
02	Byte Count	Response data byte N = W*2
03 – (N +2)	Word Value	Response word data

Error Response

Byte	Description	Value
00	Module ID	1 ~ 247
01	Function Code	0x84
02	Exception Code	Refer to section 3 – Error Response

3.6. Function 05 – Write Single Coil

This function code is used to write a value to addresses 0xxxx.

Request

Byte	Description	Value
00	Module ID	1 ~ 247
01	Function Code	0x05
02 – 03	Reference Address	Refer to section 3.1 – Address 0xxxx
04 – 05	Output Value	Output ON: 0xFF00 Output OFF: 0x0000

Response

Byte	Description	Value
00	Module ID	1 ~ 247
01	Function Code	0x05
02 – 03	Reference Address	The same as byte 02 – 03 of request
04 – 05	Output Value	The same as byte 04 – 05 of request

Error Response

Byte	Description	Value
00	Module ID	1 ~ 247
01	Function Code	0x85
02	Exception Code	Refer to section 3 – Error Response

3.7. Function 06 – Write Single Register

This function code is used to write a value to addresses 4xxxx.

Request

Byte	Description	Value
00	Module ID	1 ~ 247
01	Function Code	0x06
02 – 03	Reference Address	Refer to section 3.1 – Address 0xxxx
04 – 05	Output Value	A word value

Response

Byte	Description	Value
00	Module ID	1 ~ 247
01	Function Code	0x06
02 – 03	Reference Address	The same as byte 02 – 03 of request
04 – 05	Output Value	The same as byte 04 – 05 of request

Error Response

Byte	Description	Value
00	Module ID	1 ~ 247
01	Function Code	0x86
02	Exception Code	Refer to section 3 – Error Response

3.8. Function 15 – Write Multiple Coils

This function code is used to write values to addresses 0xxxx.

Request

Byte	Description	Value
00	Module ID	1 ~ 247
01	Function Code	0x0F
02 – 03	Reference Address	Refer to section 3.1 – Address 0xxxx
04 – 05	Bit Count	Number of bit (B) to write
06	Byte Count	Byte number N = B/7
07 – (N+6)	Write Data	A bit corresponds to a channel. Output ON: The bit = 1 Output OFF: The bit = 0

Response

Byte	Description	Value
00	Module ID	1 ~ 247
01	Function Code	0x0F
02 – 03	Reference Address	The same as byte 02 – 03 of request
04 – 05	Output Value	The same as byte 04 – 05 of request

Error Response

Byte	Description	Value
00	Module ID	1 ~ 247
01	Function Code	0x8F
02	Exception Code	Refer to section 3 – Error Response

3.9. Function 16 – Write Multiple Registers

This function code is used to write values to addresses 4xxxx.

Request

Byte	Description	Value
00	Module ID	1 ~ 247
01	Function Code	0x10
02 – 03	Reference Address	Refer to section 3.1 – Address 0xxxx
04 – 05	Word Count	Number of word (W) to write
06	Byte Count	Byte number N = W*2
07 – (N +6)	Write Data	Multiple word data

Response

Byte	Description	Value
00	Module ID	1 ~ 247
01	Function Code	0x10
02 – 03	Reference Address	The same as byte 02 – 03 of request
04 – 05	Output Value	The same as byte 04 – 05 of request

Error Response

Byte	Description	Value
00	Module ID	1 ~ 247
01	Function Code	0x90
02	Exception Code	Refer to section 3 – Error Response

3.10. Function 112 – Read/Write Module Setting

This function code is used to read the configuration settings from the module or to change the settings for the module. The following sub-function codes are supported.

Sub-function Code	Description	Section
00(0x00)	Read the name of the module	3.10.1

If the module does not support the sub-function code specified in the message, then it will respond as follows:

Error Response

Byte	Description	Value
00	Module ID	1 ~ 247
01	Function Code	0xF0
02	Exception Code	Refer to section 3 – Error Response

3.10.1. Sub-function 00 – Write time to RTC

Request

Byte	Description	Value
00	Module ID	1 ~ 255
01	Function Code	0x46
02	Sub-function code	0x00
04 – 05	Word count	0x00, 0x07
06	Byte count	0x0E
07 – 08	Year	0x07, 0xE4 => (2020)
09 – 10	Month	0x00, 0x01 => (January)
11 – 12	Day	0x00, 0x01 => (1)
13 – 14	Week	0x00, 0x01 => (Monday)
15 – 16	Hour	0x00, 0x01 => (1)
17 – 18	Minute	0x00, 0x01 => (1)
19 – 20	Second	0x00, 0x01 => (1)

Response

Byte	Description	Value
00	Module ID	1 ~ 255
01	Function Code	0x46
02 – 03	Sub-function Code	0x00
04 – 05	Word count	0x53 0x43 0x41 0x02 (SC-4102)

Error Response

Byte	Description	Value
00	Module ID	1 ~ 255
01	Function Code	0xF0
02	Exception Code	Refer to section 3 – Error Response

4. Web Setting

4.1. Configuring Network Settings

1. Downloaded the eSearch Utility and installed according to the installation instructions.

The eSearch Utility can be obtained from the ICP DAS web site. The location of the download addresses is shown below:

<https://www.icpdas.com/en/download/index.php?nation=US&kind1=&model=&kw=eSearch>

2. Double click the eSearch Utility shortcut on the desktop.
3. Click the “Search Servers” button to search your RPS-4M ◦
4. Once the search process is complete, double-click the name of the RPS-4M to open the “Configure Server” dialog box.

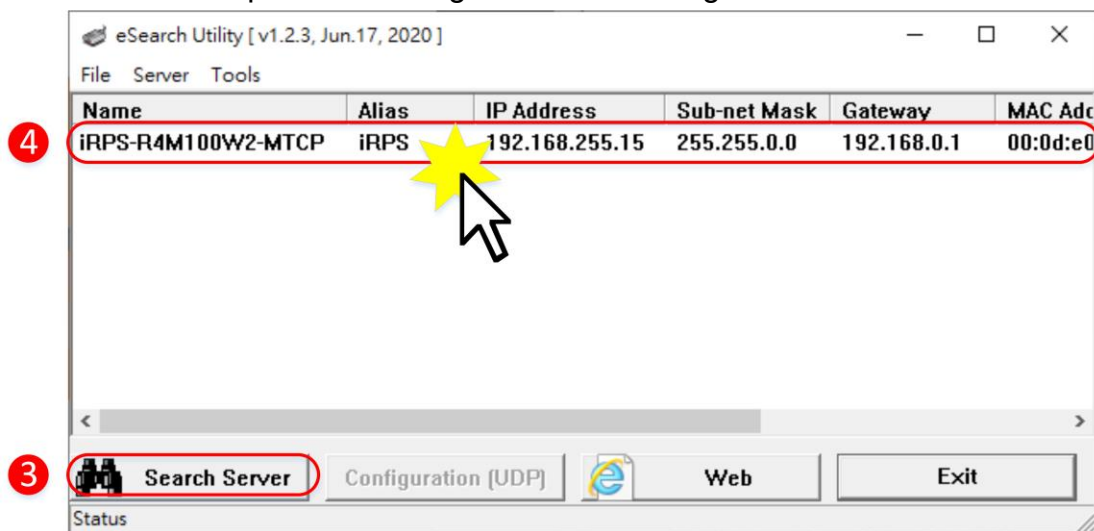

Factory Default Settings of RPS-4M Module:

IP Address	192.168.255.1
Subnet Mask	255.255.0.0
Gateway	192.168.0.1

5. Enter the network settings information, including the IP, Mask and Gateway addresses, and then click “OK” button.

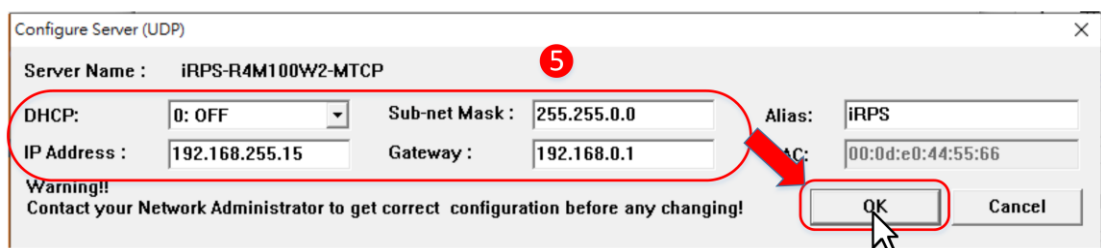

4.2. Home Page

1. Press the “Web” button

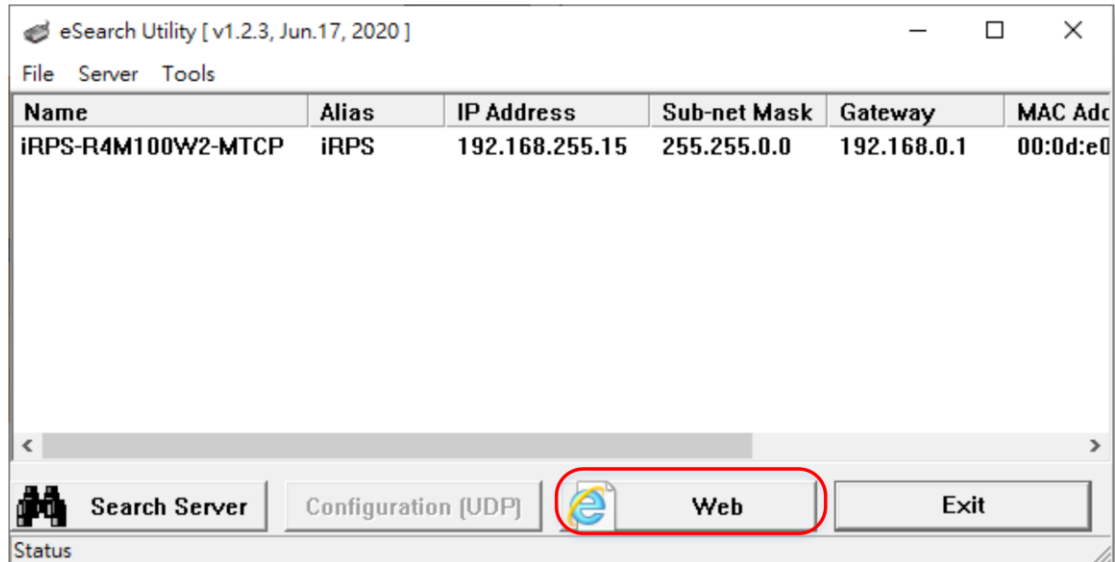

2. Enter a password (the factory default password is “admin”), and then click the “Submit” button to continue.

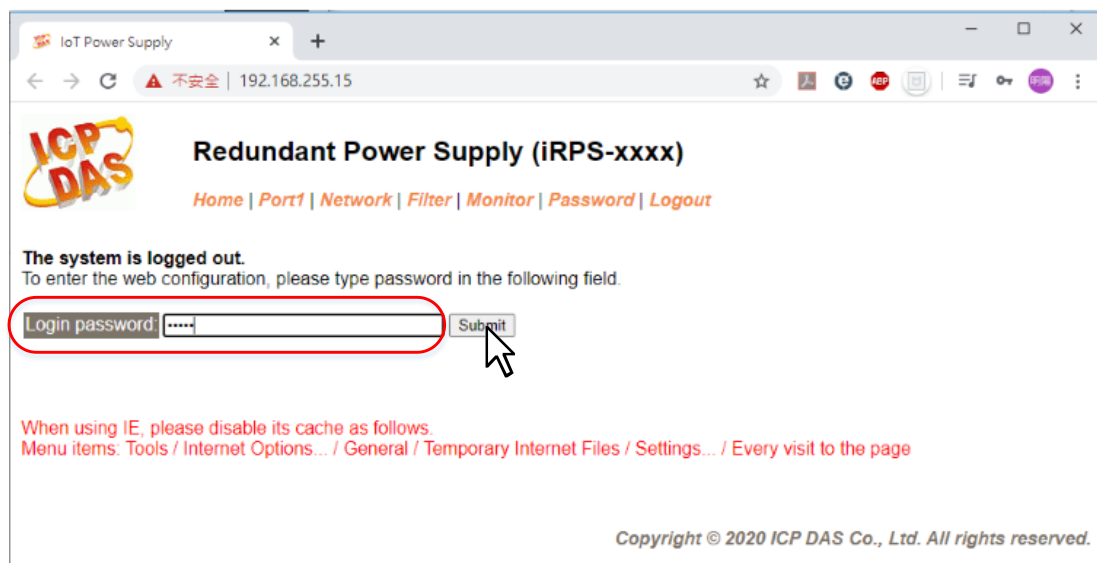

3. The Home link connects to the main page. The software and hardware information section includes information related to the Model Name, the current Firmware version, the IP Address, the current position of the Initial Switch, the Alias, the MAC Address, and the TCP Port, and the Serial Port.

IoT Power Supply x +

← → ↻ 不安全 | 192.168.255.1 ☆



Redundant Power Supply (iRPS-xxxx)

[Home](#) | [Port1](#) | [Network](#) | [Filter](#) | [Monitor](#) | [Password](#) | [Logout](#)

Model Name	iRPS-R4M100W2-MTCP	Alias Name	iRPS
Firmware Version	B1.0.0 [Jun.1 2020]	MAC Address	00-0d-e0-44-55-66
IP Address	192.168.255.1	TCP Port Timeout (Socket Watchdog, Seconds)	180
Initial Switch	OFF	System Idle (Network Watchdog, Seconds)	0

Current port settings:

TCP Port Settings	Value
Local TCP Port	502
Serial Port Settings	
Baud Rate (bps)	9600 bps
Line Control	8, N, 1

Copyright © 2020 ICP DAS Co., Ltd. All rights reserved.

4.3. Port Page

1. Click the “Port1” tab to display the Port1 Settings page.

The screenshot shows the web interface for an IoT Power Supply. The browser address bar shows the URL 192.168.255.1. The page title is "Redundant Power Supply (IRPS-xxxx)". The navigation menu includes Home, Port1, Network, Filter, Monitor, Password, and Logout. The "Port1" tab is selected and highlighted with a red box and a mouse cursor. Below the navigation menu, there are two columns of device information:

Model Name	IRPS-R4M100W2-MTCP	Alias Name	iRPS
Firmware Version	B1.0.0 [Jun. 1 2020]	MAC Address	00-0d-e0-44-55-66
IP Address	192.168.255.1	TCP Port Timeout (Socket Watchdog, Seconds)	180
Initial Switch	OFF	System Idle (Network Watchdog, Seconds)	0

Below the device information, there is a "Settings:" section with two tables:

TCP Port Settings	Current	Updated	Comment
Local TCP Port	502	<input type="text" value="502"/>	Default: 502
		<input type="button" value="Submit"/>	

Serial Port Settings	Current	Updated	Comment
Baud Rate (bps)	9600 bps	<input type="text" value="9600"/> bps	Default: 9600 bps
Line Control	8, N, 1	<input type="text" value="8, N, 1"/>	Default: 8, N, 1
		<input type="button" value="SerialSubmit"/>	

Red boxes and numbers 1, 2, and 3 highlight the "Port1" tab, the "Submit" button for TCP settings, and the "SerialSubmit" button for serial settings, respectively.

Copyright © 2020 ICP DAS Co., Ltd. All rights reserved.

2. Select the appropriate Baud Rate, Data Format (e.g., 19200, 8N1) from the relevant drop down options.
3. Click “Submit” to save your settings.

4.4. Network Page

1. Click Network tab to enter Network page.

2. The following is an overview of the parameters contained in the IP Address Selection section:

Item	Description
Address Type	Static IP: If no DHCP server is installed on the network, the network settings can be configured manually.
	DHCP: The Dynamic Host Configuration Protocol (DHCP) is a network application protocol that automatically assigns an IP address to each device
Static Address	This parameter is used to assign a specific IP address.
Subnet Mask	This parameter is used to assign the subnet mask for the RPS-4M. The subnet mask indicates which portion of the IP address is used to identify the local network or subnet.
Default Gateway	This parameter is used to assign the IP Address of the Gateway.
MAC Address	This parameter is used to set a user-defined MAC address.

3. The following is an overview of the parameters contained in the General

Settings section:

Item	Description
HTTP Port	This parameter is used to assign specific a HTTP port of RPS-4M. The RPS-4M needs to be restarted when the HTTP port is changed. You need manually type the new HTTP port in the address bar of the browser. The default is 80.
Alias Name	This parameter is used to assign an alias for each RPS-4M to assist with easy identification.
TCP Port Timeout	This parameter is used to configure the TCP Port timeout value. If there is no activity on the network for a specific period of time, RPS-4M will close the connection to the client.
Web Auto-logout	This parameter is used to configure the automatic logout value. If there is no activity on the web server for a certain period of time, the current user account will be automatically logged out.
UDP Configuration	This parameter is used to enable or disable UDP configuration function

4. Use can change the Modbus node ID in Modbus Setting section.
5. Restore Factory Defaults section include two part:

Item	Description
Restore Defaults	Reset all parameters to their original factory default settings
Reboot	Force the RPS-4M to reboot or to remotely reboot the device.

6. Update by Ethernet function can update firmware remotely. Traditional firmware update requires adjusting the Init/Run Switch and reboots the module manually for the initialization of firmware update, while new firmware allows user to initialize the module via web interface without adjusting the hardware switch. Initialization via web is useful when module is installed in remote site and can be accessed by a remote PC via TeamViewer
For more details, refer to appendix A.

IoT Power Supply x +

← → ↻ 不安全 | 192.168.255.1 ☆ 人 e ASP 刷新 明

ICP DAS **Redundant Power Supply (iRPS-xxxx)**
[Home](#) | [Port1](#) | [Network](#) | [Filter](#) | [Monitor](#) | [Password](#) | [Logout](#)

General Settings 3

Ethernet Speed	Auto	(Auto=10/100 Mbps Auto-negotiation)
HTTP port	80	(Default= 80)
Alias Name	iRPS	(Max. 18 chars)
TCP Port Timeout (Socket Watchdog)	180	(0 ~ 86400 seconds, Default: 180, Disable: 0)
Web Auto-logout	10	(1 ~ 65535 minutes, Default: 10, Disable: 0)
UDP Configuration:	Enable	(Enable/Disable the UDP Configuration, Enable=default.)

Modbus Settings 4

Drops packet when Modbus TCP header (protocol ID, length) is wrong.

Gateway Net ID	1	(Default: 255)
----------------	---	----------------

Note: This is reserved for gateway, NOT for slave devices.

Restore Factory Defaults 5

Restore all options to their factory default states:

Forced Reboot

Update by Ethernet 6

If the remote firmware update is failed, then the traditional firmware update (on-site) is required to make the module working again.

Step 1: Refer to firmware update manual first.
 Step 2: Run eSearch Utility to prepare and wait for update.
 Step 3: Click the [Update] button to **reboot** the module and start update.
 Step 4: Configure the module again.

Copyright © 2020 ICP DAS Co., Ltd. All rights reserved.

4.5. Filter Page

The Accessible IP (filter is disabled when all zero) Settings page is used to query or edit the IP Filter List. The IP Filter List restricts the access of packets based on the IP header. If one or more IP address are saved to the IP Filter table, only clients whose IP is specified in the IP Filter List can access the RPS-4M.

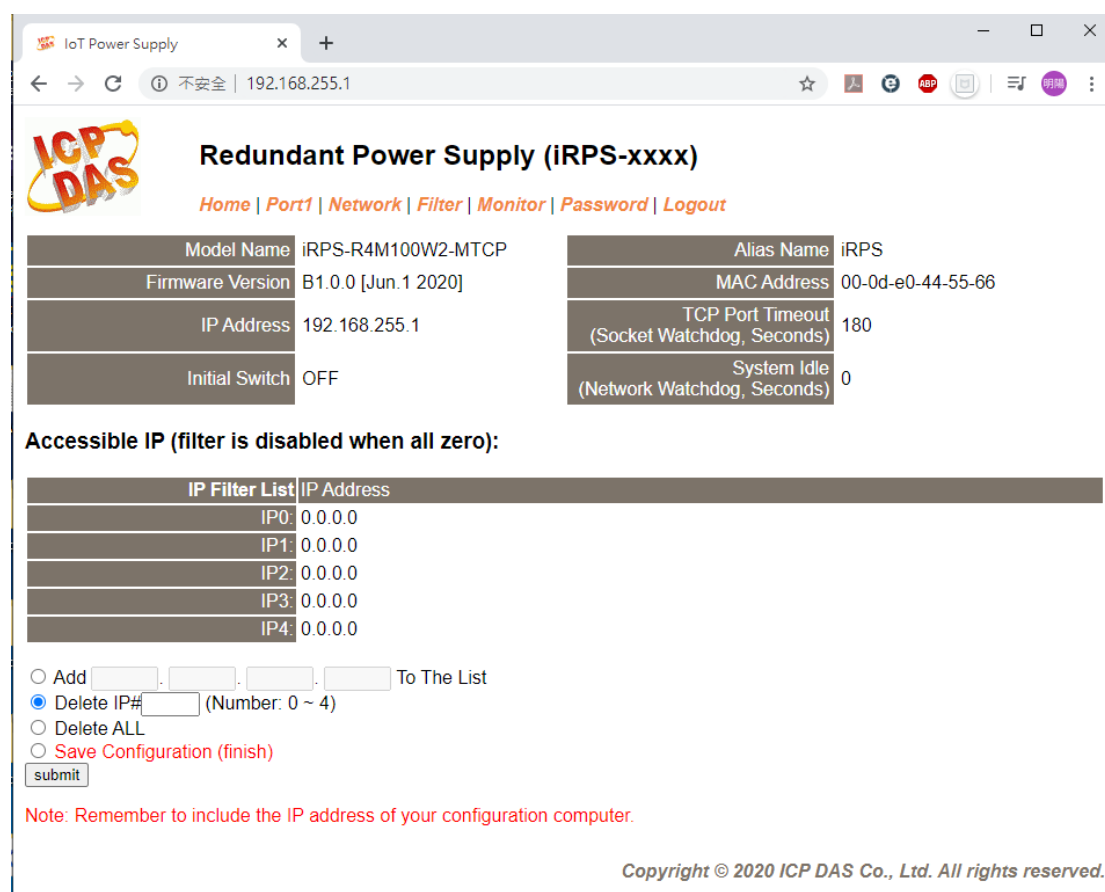

Redundant Power Supply (iRPS-xxxx)

[Home](#) | [Port1](#) | [Network](#) | [Filter](#) | [Monitor](#) | [Password](#) | [Logout](#)

Model Name	iRPS-R4M100W2-MTCP	Alias Name	iRPS
Firmware Version	B1.0.0 [Jun.1 2020]	MAC Address	00-0d-e0-44-55-66
IP Address	192.168.255.1	TCP Port Timeout (Socket Watchdog, Seconds)	180
Initial Switch	OFF	System Idle (Network Watchdog, Seconds)	0

Accessible IP (filter is disabled when all zero):

IP Filter List	IP Address
IP0:	0.0.0.0
IP1:	0.0.0.0
IP2:	0.0.0.0
IP3:	0.0.0.0
IP4:	0.0.0.0

Add . . . To The List
 Delete IP# (Number: 0 ~ 4)
 Delete ALL
 Save Configuration (finish)

Note: Remember to include the IP address of your configuration computer.

Copyright © 2020 ICP DAS Co., Ltd. All rights reserved.

The following is an overview of the parameters contained in the Accessible IP section:

Item	Description
Add "IP" to the list	Add an IP address to the IP Filter List.
Delete IP# "Number"	Delete a specific IP# (Number = 0 to 4) address from the IP Filter List
Delete All	Delete all items from the IP Filter List.
Save Configuration(finish)	Save a new IP Filter List to the Flash memory

4.6. Monitor Page

User can check of the IPs which connect to RPS-4M.

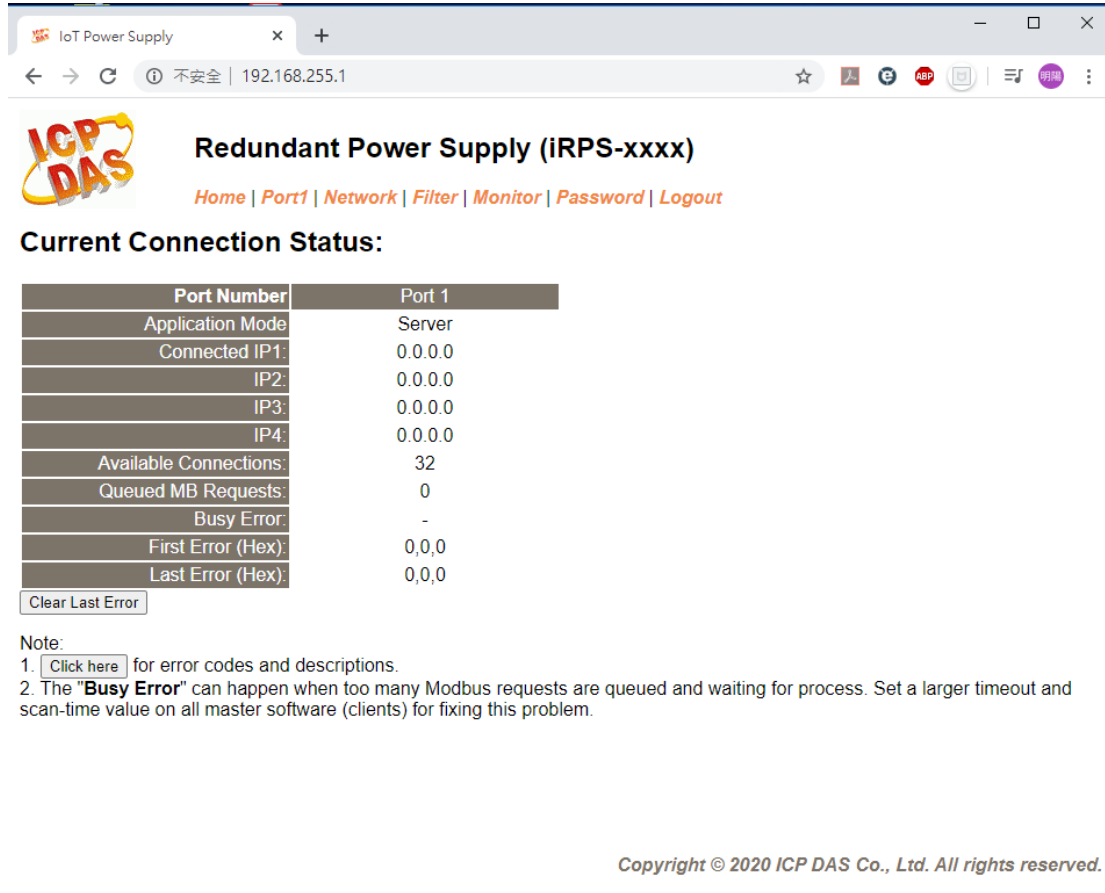

The screenshot shows a web browser window with the URL 192.168.255.1. The page title is "Redundant Power Supply (iRPS-xxxx)". The navigation menu includes [Home](#), [Port1](#), [Network](#), [Filter](#), [Monitor](#), [Password](#), and [Logout](#). The main content area is titled "Current Connection Status:" and contains a table with the following data:

Port Number	Port 1
Application Mode	Server
Connected IP1:	0.0.0.0
IP2:	0.0.0.0
IP3:	0.0.0.0
IP4:	0.0.0.0
Available Connections:	32
Queued MB Requests:	0
Busy Error:	-
First Error (Hex):	0,0,0
Last Error (Hex):	0,0,0

Below the table is a button labeled "Clear Last Error".

Note:

- [Click here](#) for error codes and descriptions.
- The "**Busy Error**" can happen when too many Modbus requests are queued and waiting for process. Set a larger timeout and scan-time value on all master software (clients) for fixing this problem.

Copyright © 2020 ICP DAS Co., Ltd. All rights reserved.

4.7. Password Page

After clicking the Password tab, the Change Password page will be displayed. The following are the steps for changing password.

Step 1: Enter the old password in the “Current password” field

(Note: Use the default password “admin”, when change password for the first time.)

Step 2: Enter a new password in the “New password” field ◦

Step 3: Re-enter the new password in the “Confirm new password” field.

Step 4: Click the “Submit” button to update the password.

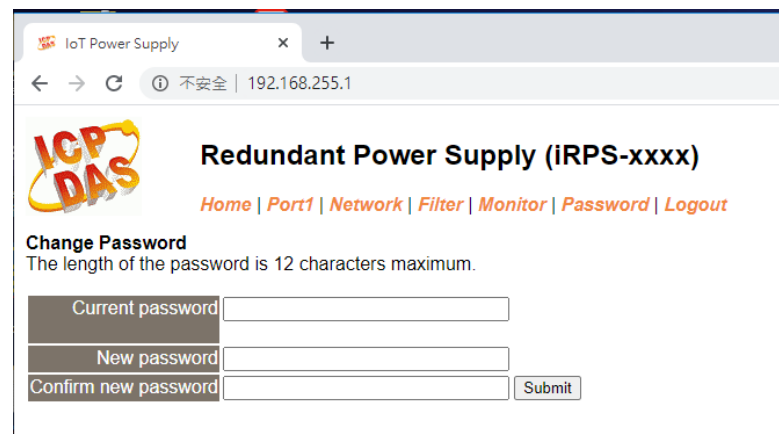

IoT Power Supply x +

← → ↻ 不安全 | 192.168.255.1

ICP DAS **Redundant Power Supply (iRPS-xxxx)**

[Home](#) | [Port1](#) | [Network](#) | [Filter](#) | [Monitor](#) | [Password](#) | [Logout](#)

Change Password
The length of the password is 12 characters maximum.

Current password	<input type="text"/>
New password	<input type="text"/>
Confirm new password	<input type="text"/>

4.8. Logout Page

After clicking the Logout tab, you will be immediately logged out from the system and be returned to the login page.

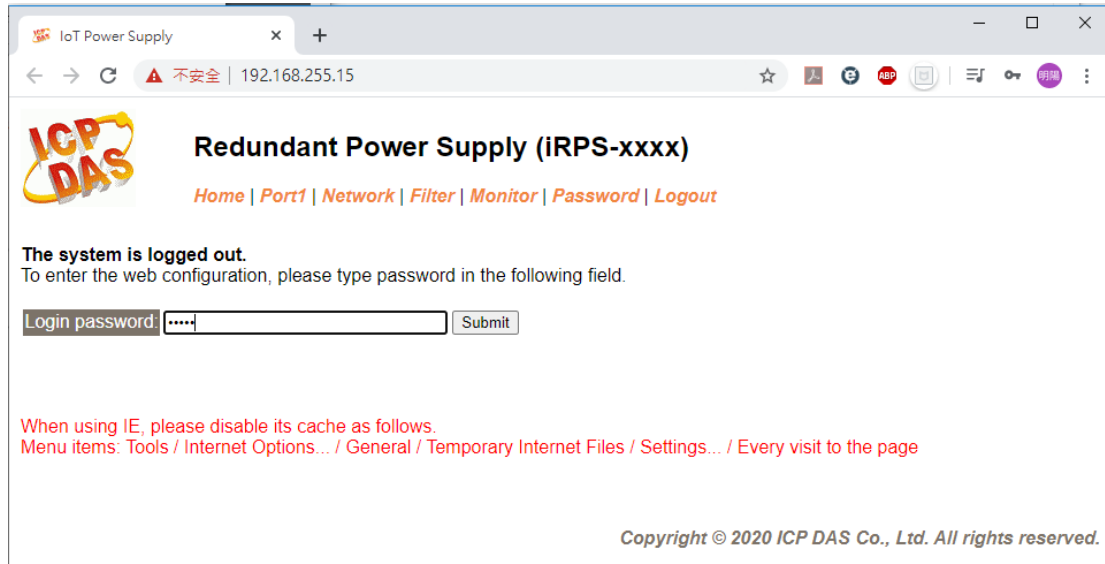

5. Appendix A

5.1. Firmware update

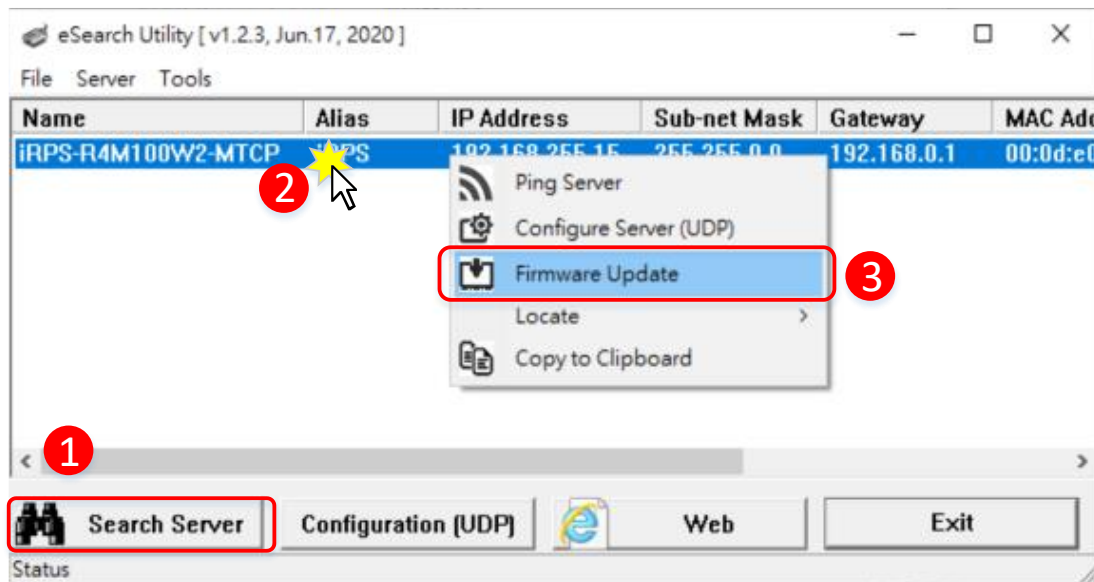

Step 1: In the eSearch Utility, click the “Search Servers” button to search the for any

RPS-4M modules connected to the network .

Step 2: Right click on the name of the RPS-4M module to be updated.

Step 3: Select the “Firmware Update” item from the popup menu and the “Open”

dialog box will be displayed.

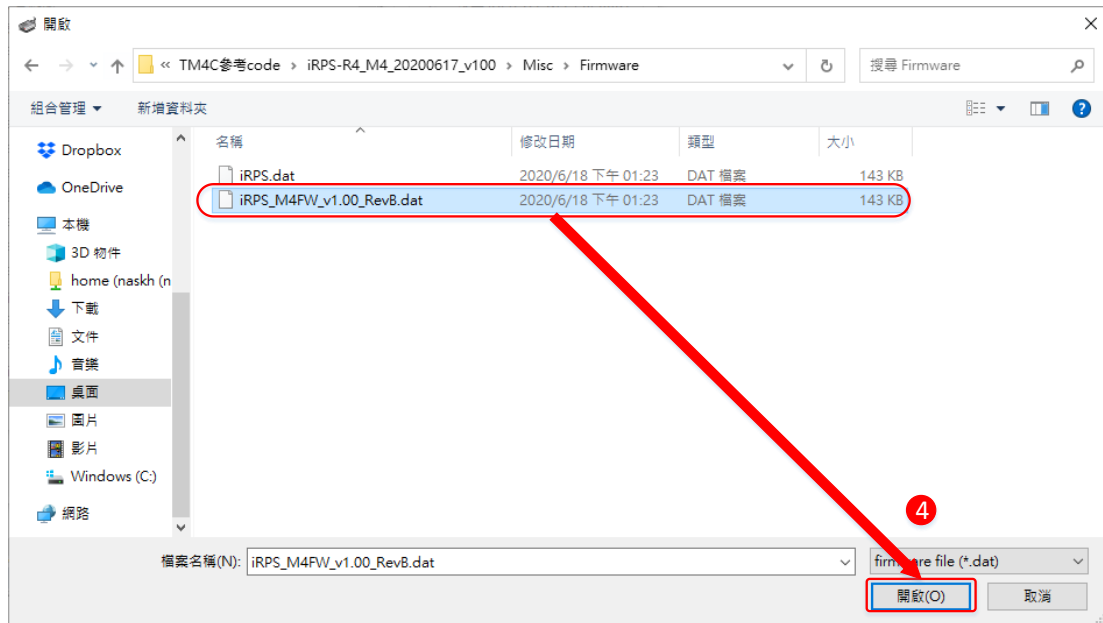

Step 4: In the “Open” dialog box, select the firmware file that will be used to update the module and then click the “Open” button.

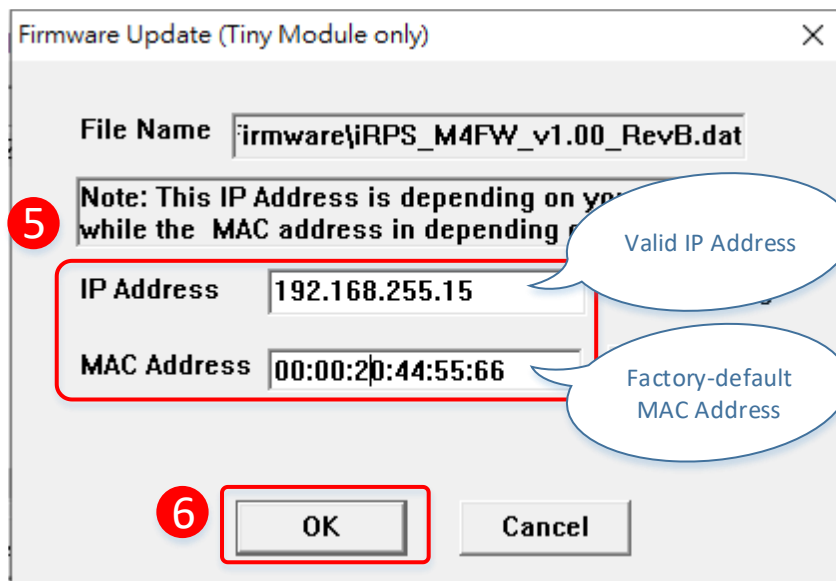

Step 5: Assign a valid IP Address (can be different with the current IP) and the factory-default MAC Address for the RPS-4M module. If this IP address is invalid (e.g. IP Address: 0.0.0.0) or a user-defined MAC address is assigned. Refer to note 2 and note 3 for more details.

Step 6: Click the “OK” button.

Waiting for a request from this MAC address.



```
C:\WINDOWS\system32\cmd.exe
Waiting request from MAC 00-00-20-44-55-66 (IP:192.168.255.15)
Starting BOOTP/TFTP Server ...
% Complete: 0%
```

Step 7: You are now ready to update the firmware. A Command Prompt windows

will be displayed the progress of the update.

Step 8: Click the “Network Setting” tab to display the Network Settings page

Step 9: Click the “Update” button in the “Remote Firmware Update” section to start

the update

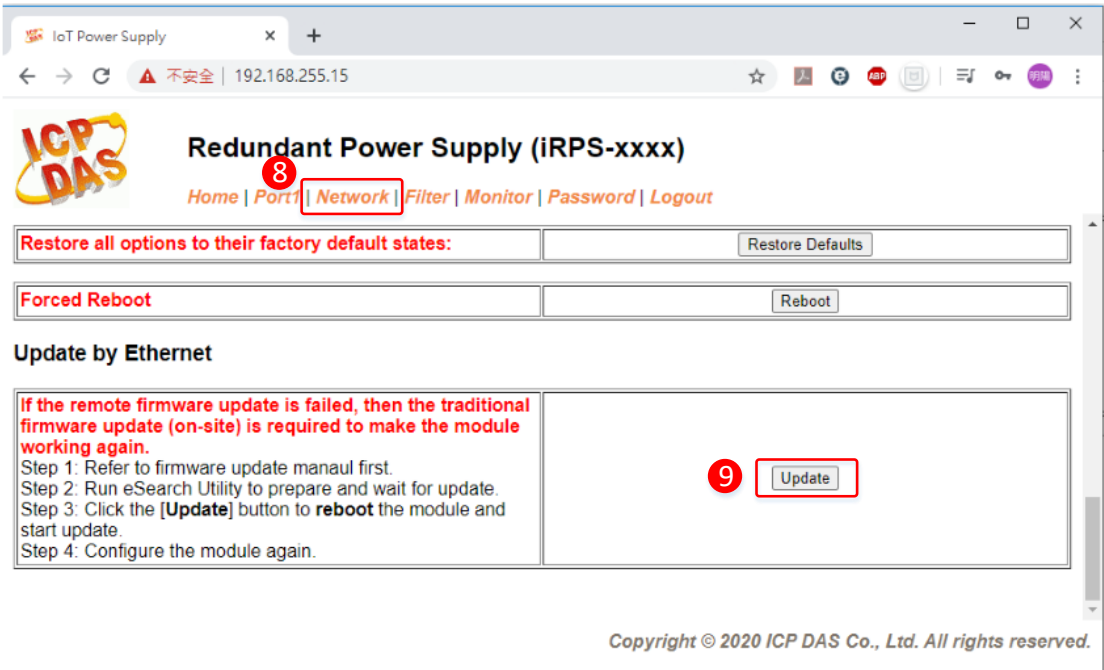

Step 10: Confirm that the two MAC addresses (factory-default) listed in the Command Prompt window, “Waiting request from MAC x.x.x.x” and “BOOTPREQ from MAC: x.x.x.x”, are the same, as indicated in the image below. If these addresses do not match, the update cannot proceed. Refer

to note4

below for more details.

Step 11: Once the update is complete (i.e., when the progress indicator reaches 100%),

close the Command Prompt window.

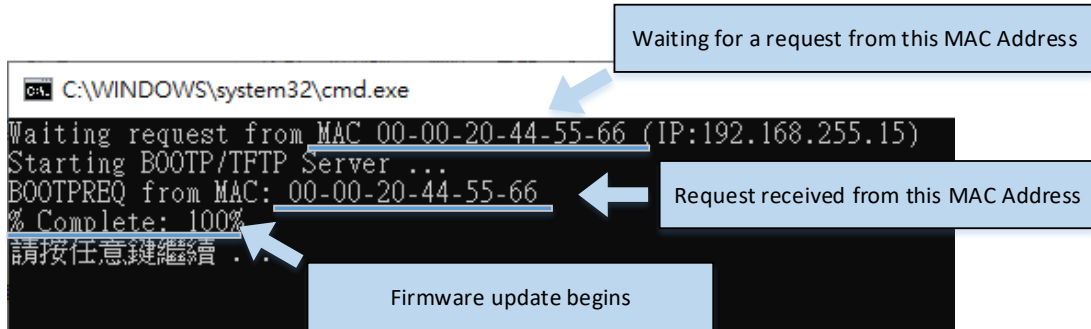

Note 1: If the IP address settings do not work correctly (e.g. there is no response to a ping command), please contact your network administrator to obtain a valid IP address for the RPS-4M module.

Note 2: If the settings displayed in the IP address field of the firmware update window is incorrect or invalid (e.g. IP address: 0.0.0.0), then a valid IP address must be manually specified for the RPS-4M in order to process the update operation. Please contact your network administrator to obtain a valid IP address before proceeding.

Note 3: When updating the firmware, the factory-default MAC address is used rather than the user-defined MAC address. Thus, the MAC address (user-defined) displayed in the firmware update window may not be the one required. If this is the case, the factory-default MAC address should be manually entered into the MAC Address field, or restore the MAC address to the factory-default settings via the web configuration pages.

Note 4: The “BOOTREQ from MAC: xx-xx-xx-xx-xx-xx” message indicates there is a module with the factory-default MAC address “xx-xx...” that is asking for the firmware to be updated. The update process will not begin if you assign a user-defined MAC address in the firmware update window, since the addresses do not match. If this situation occurs, repeat the update procedure and manually enter the factory-default MAC address in the firmware update window, as described in Step 5. The firmware update procedure is illustrated in the figure below

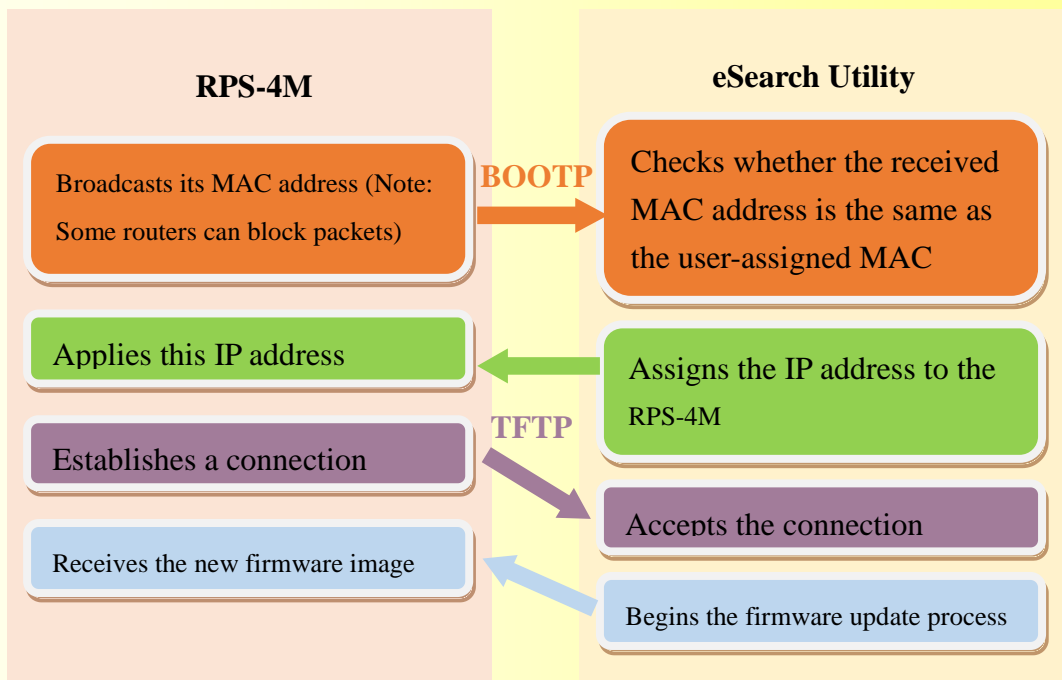

Note 5: BOOTP (Bootstrap Protocol) is defined in RFC-951 and uses UDP ports 67 and 68.

Note 6: TFTP (Trivial File Transfer Protocol) is defined in RFC-1350 and uses UDP port 69