

PCI-1780

8-ch Counter/Timer Card

User Manual

Copyright

The documentation and the software included with this product are copyrighted 2002 by Advantech Co., Ltd. All rights are reserved. Advantech Co., Ltd. reserves the right to make improvements in the products described in this manual at any time without notice. No part of this manual may be reproduced, copied, translated or transmitted in any form or by any means without the prior written permission of Advantech Co., Ltd. Information provided in this manual is intended to be accurate and reliable. However, Advantech Co., Ltd. assumes no responsibility for its use, nor for any infringements of the rights of third parties, which may result from its use.

Acknowledgments

PC-LabCard is a trademark of Advantech Co., Ltd. IBM and PC are trademarks of International Business Machines Corporation. MS-DOS, Windows, Microsoft Visual C++ and Visual BASIC are trademarks of Microsoft Corporation. Intel and Pentium are trademarks of Intel Corporation. Delphi and C++ Builder are trademarks of Inprise Corporation.

CE notification

The PCI-1780, developed by ADVANTECH CO., LTD., has passed the CE test for environmental specifications when shielded cables are used for external wiring. We recommend the use of shielded cables. This kind of cable is available from Advantech. Please contact your local supplier for ordering information.

On-line Technical Support

For technical support and service, please visit our support website at:
<http://www.advantech.com/support>

Note:

- ✎ Concerning environmental protection, to reduce the paper used for the user's manual. Starting the page of *Appendix C*, please use the PDF file on the CD-ROM or download form support on www.advantech.com.
-

Part No. 2003178010

2nd Edition

Printed in Taiwan

May 2005

Contents

1. INTRODUCTION	1
1.1 FEATURES	1
1.2 APPLICATIONS	3
1.3 INSTALLATION GUIDE.....	3
1.4 SOFTWARE OVERVIEW.....	5
1.5 DEVICE DRIVERS PROGRAMMING ROADMAP	6
1.6 ACCESSORIES	8
2. INSTALLATION	9
2.1 UNPACKING.....	9
2.2 DRIVER INSTALLATION	11
2.3 HARDWARE INSTALLATION.....	12
2.4 DEVICE SETUP & CONFIGURATION.....	15
3. SIGNAL CONNECTIONS	19
3.1 OVERVIEW	19
3.2 SWITCH AND JUMPER SETTINGS	19
3.3 SIGNAL CONNECTIONS	21
APPENDIX A. SPECIFICATIONS	25
APPENDIX B. BLOCK DIAGRAM	27
APPENDIX C. REGISTER STRUCTURE AND FORMAT	29
C.1 OVERVIEW	29
C.2 I/O PORT ADDRESS MAP	29
C.3 COUNTER 0/1/2/3/4/5/6/7 MODE — BASE+00/08/10/18/20/28/30/38H	36
C.4 COUNTER 0/1/2/3/4/5/6/7 LOAD — BASE+02/0A/12/1A/22/2A/32/3AH	39
C.5 COUNTER 0/1/2/3/4/5/6/7 HOLD — BASE+04/0C/14/1C/24/2C/34/3CH	40
C.6 COUNTER 0/1/2/3/4/5/6/7 COMMAND — BASE+06/0E/16/1E/26/2E/36/3EH	41
C.7 COMMAND ENABLE — BASE+40H	42
C.8 INTERRUPT CONTROL — BASE+42H.....	43
C.9 INTERRUPT STATUS — BASE+42H	43

C.10	CLEAR INTERRUPT — BASE+44H.....	44
C.11	DIGITAL OUTPUT — BASE+48H.....	44
C.12	DIGITAL INPUT — BASE+48H.....	44
C.13	BOARD ID — BASE+4EH.....	45
C.14	FOUT 0/1/2/3/4/5/6/7 CONTROL — BASE + 50~5FH.....	46
APPENDIX D. WAVEFORM OF EACH MODE		49
D.1	MODE A WAVEFORM	51
D.2	MODE B WAVEFORM.....	52
D.3	MODE C WAVEFORM.....	53
D.4	MODE D WAVEFORM	54
D.5	MODE E WAVEFORM.....	55
D.6	MODE F WAVEFORM	56
D.7	MODE G WAVEFORM	57
D.8	MODE H WAVEFORM	58
D.9	MODE I WAVEFORM.....	59
D.10	MODE J WAVEFORM.....	60
D.11	MODE K WAVEFORM.....	61
D.12	MODE L WAVEFORM	62
D.13	MODE O WAVEFORM	63
D.14	MODE R WAVEFORM.....	64
D.15	MODE U WAVEFORM	65
D.16	MODE X WAVEFORM	66

1. Introduction

Thank you for buying the Advantech PCI-1780. The PCI-1780 is a general purpose multiple channel counter/timer card for the PCI bus. It targets the AM9513 to implement the counter/timer function by CPLD. It provides eight 16-bit counter channels and 8 digital outputs and 8 digital inputs. The powerful Advantech-designed counter functions fulfill your industrial or laboratory application needs.

The following sections of this chapter will provide further information about features of the multifunction cards, a Quick Start for installation, together with some brief information on software and accessories for the PCI-1780 card.

1.1 Features

- 8 independent 16-bit counters
- 8 programmable clock source
- 8 digital TTL outputs and 8 digital TTL inputs
- Up to 20 MHz input frequency
- Multiple counter clock source selectable
- Counter output programmable
- Counter gate function
- Flexible interrupt source select
- Board ID

The Advantech PCI-1780 offers the following main features:

Flexible Counter Modes

The PCI-1780 features up to 12 programmable counter modes, to provides one shot output, PWM output, periodic interrupt output, time-delay output, and to measurement the frequency and the pulse width. The PCI-1780 is an ideal solution for variant counter/timer applications.

Special Shielded Cable for Noise Reduction

The PCL-10168 shielded cable is specially designed for the PCI-1780 for reducing noise. Its wires are all twisted pairs, with input signals and output signals separately shielded, providing minimal cross talk between signals and offering the best protection against EMI/EMC problems.

Counter mode table:

(N: No gate control, L: Level gate control, E: Edge gate control)

Counter Mode	A	B	C	D	E	F	G	H	I	J	K	L
Special Gate (CM6)	0	0	0	0	0	0	0	0	0	0	0	0
Reload Source (CM5)	0	0	0	0	0	0	1	1	1	1	1	1
Repetition (CM4)	0	0	0	1	1	1	0	0	0	1	1	1
Gate Control (CM15~CM12)	N	L	E	N	L	E	N	L	E	N	L	E
Count to TC once, then disarm	✓	✓	✓									
Count to TC twice, then disarm							✓	✓	✓			
Count to TC repeatedly without disarming				✓	✓	✓				✓	✓	✓
Gate input dose not gate counter input	✓			✓			✓			✓		
Count only during active gate level		✓			✓			✓			✓	
Start count on active gate edge and stop count on next TC			✓			✓						
Start count on active gate edge and stop count on second TC									✓			✓
Start count on active gate edge and stop count on inactive gate edge												
Reload counter from Load Register on TC	✓	✓	✓	✓	✓	✓						
Reload counter on each TC, alternating reload source between Load and Hold Registers							✓	✓	✓	✓	✓	✓

Counter Mode	M	N	O	P	Q	R	S	T	U	V	W	X
Special Gate (CM6)	1	1	1	1	1	1	1	1	1	1	1	1
Reload Source (CM5)	0	0	0	0	0	0	1	1	1	1	1	1
Repetition (CM4)	0	0	0	1	1	1	0	0	0	1	1	1
Gate Control (CM15~CM12)	N	L	E	N	L	E	N	L	E	N	L	E
Count to TC once, then disarm	✓	✓	✓									
Count to TC twice, then disarm							✓	✓	✓			
Count to TC repeatedly without disarming				✓	✓	✓				✓	✓	✓
Gate input dose not gate counter input	✓			✓			✓			✓		
Count only during active gate level		✓			✓			✓			✓	
Start count on active gate edge and stop count on next TC			✓			✓						
Start count on active gate edge and stop count on second TC									✓			✓
Start count on active gate edge and stop count on inactive gate edge			✓			✓			✓			✓
Reload counter from Load Register on TC	✓	✓	✓	✓	✓	✓						
Reload counter on each TC, alternating reload source between Load and Hold Registers							✓	✓	✓	✓	✓	✓

Note: Counter modes M, N, P, Q, S, T, V, W are identical to A, B, D, E, G, H, J, K.

Note:

 For detailed specifications of the PCI-1780, please refer to *Appendix A, Specifications*.

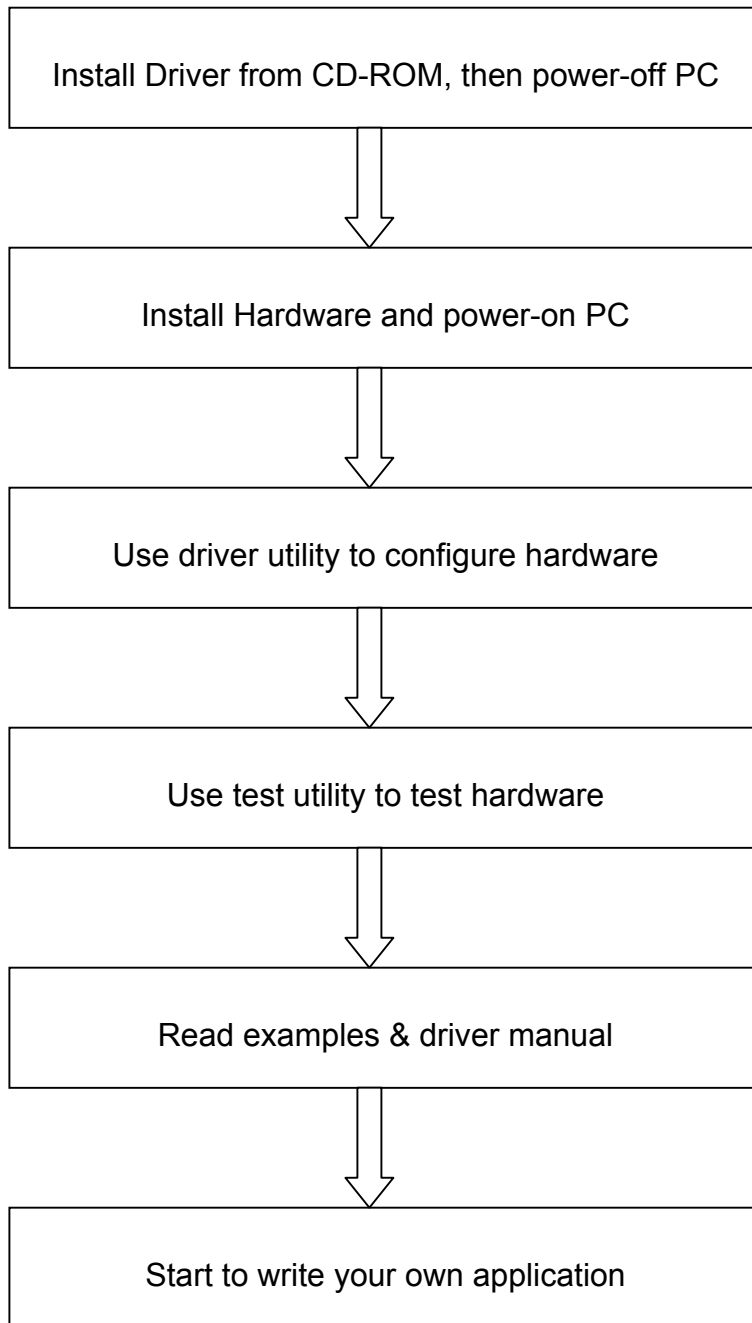

Fig. 1-1 Installation Flow Chart

1.4 Software Overview

Advantech offers a rich set of DLL drivers, third-party driver support and application software to help fully utilize the functions of your PCI-1780 card:

- ❑ Device Drivers (on the companion CD-ROM)
- ❑ LabVIEW driver*
- ❑ Advantech ActiveDAQ
- ❑ Advantech GeniDAQ

Programming choices for DA&C cards: You may use Advantech application software such as Advantech Device Drivers. On the other hand, advanced users can use another option for register-level programming, although it is not recommended due to its laborious and time-consuming nature.

Device Drivers

The Advantech Device Drivers software is included on the companion CD-ROM at no extra charge. It also comes with all Advantech DA&C cards. Advantech's device drivers feature a complete I/O function library to help boost your application performance. The Advantech Device Drivers for Windows 2000/95/98/ ME/NT/XP works seamlessly with development tools such as Visual C++, Visual Basic, Inprise C++ Builder and Inprise Delphi.

Register-level Programming

Register-level programming is reserved for experienced programmers who find it necessary to write code directly at the level of device registers. Since register-level programming requires much effort and time, we recommend that you use the Advantech Device Drivers instead. However, if register-level programming is necessary, you should refer to the relevant information in *Appendix C, Register Structure and Format*, or to the example codes included on the companion CD-ROM.

1.5 Device Drivers Programming Roadmap

This section will provide you a roadmap to demonstrate how to build an application from scratch using Advantech Device Drivers with your favorite development tools such as Visual C++, Visual Basic, Delphi and C++ Builder. The step-by-step instructions on how to build your own applications using each development tool will be given in the *Device Drivers Manual*. Moreover, a rich set of example source code is also given for your reference.

Programming Tools

Programmers can develop application programs with their favorite development tools:

- ❑ **Visual C++**
- ❑ **Visual Basic**
- ❑ **Delphi**
- ❑ **C++ Builder**

For instructions on how to begin programming works in each development tool, Advantech offers a *Tutorial* Chapter in the *Device Drivers Manual* for your reference. Please refer to the corresponding sections in this chapter of the *Device Drivers Manual* to begin your programming efforts. You can also look at the example source code provided for each programming tool, since they can get you very well oriented.

The *Device Drivers Manual* can be found on the companion CD-ROM. Or if you have already installed the Device Drivers on your system, The *Device Drivers Manual* can be readily accessed through the **Start** button:

Start/Programs/Advantech Driver V2.0a/Device Driver Manual

The example source codes could be found under the corresponding installation folder such as the default installation path:

\Program Files\Advantech\ADSAPI\Examples

For information about using other function groups or other development tools, please refer to the *Creating Windows 95/NT/2000 Application with Device Drivers* chapter and the *Function Overview* chapter on the *Device Drivers Manual*.

Programming with Device Drivers Function Library

Advantech Device Drivers offers a rich function library to be utilized in various application programs. This function library consists of numerous APIs that support many development tools, such as Visual C++, Visual Basic, Delphi and C++ Builder.

According to their specific functions or services, those APIs can be categorized into several function groups:

- ❑ **Digital Input/Output Function Group**
- ❑ **Counter Function Group**
- ❑ **Port Function Group (direct I/O)**
- ❑ **Event Function Group**

For the usage and parameters of each function, please refer to the *Function Overview* chapter in the *Device Drivers Manual*.

Troubleshooting Device Drivers Error

Driver functions will return a status code when they are called to perform a certain task for the application. When a function returns a code that is not zero, it means the function has failed to perform its designated function. To troubleshoot the Device Drivers error, you can pass the error code to **DRV_GetErrorMessage** function to return the error message. Or you can refer to the *Device Drivers Error Codes* Appendix in the *Device Drivers Manual* for a detailed listing of the Error Code, Error ID and the Error Message.

1.6 Accessories

Advantech offers a complete set of accessory products to support the PCI-1780 card. These accessories include:

Wiring Cable

- **PCL-10168** The PCL-10168 shielded cable is specially designed for PCI-1780 cards to provide high resistance to noise. To achieve better signal quality, the signal wires are twisted in such a way as to form a “twisted-pair cable,” reducing cross-talk and noise from other signal sources. Furthermore, its analog and digital lines are separately sheathed and shielded to neutralize EMI/EMC problems.

Wiring Boards

- **ADAM-3968** The ADAM-3968 is a 68-pin SCSI-II wiring terminal module for DIN-rail mounting. This terminal module can be readily connected to the Advantech PC-Lab cards and allow easy yet reliable access to individual pin connections for the PCI-1780 card.

2. Installation

This chapter gives users a package item checklist, proper instructions about unpacking and step-by-step procedures for both driver and card installation.

2.1 Unpacking

After receiving your PCI-1780 package, please inspect its contents first. The package should contain the following items:

- PCI-1780 card
- Companion CD-ROM (DLL driver included)
- User's Manual

The PCI-1780 card harbors certain electronic components vulnerable to *electrostatic discharge* (ESD). ESD could easily damage the integrated circuits and certain components if preventive measures are not carefully paid attention to.

Before removing the card from the antistatic plastic bag, you should take following precautions to ward off possible ESD damage:

- Touch the metal part of your computer chassis with your hand to discharge static electricity accumulated on your body. Or use a grounding strap.
- Touch the anti-static bag to a metal part of your computer chassis before opening the bag.
- Take hold of the card only by the metal bracket when removing it from the bag.

After taking out the card, first you should:

- Inspect the card for any possible signs of external damage (loose or damaged components, etc.). If the card is visibly damaged, please notify our service department or the local sales representative immediately. Avoid installing a damaged card into your system.

Also, pay extra caution to the following aspects to ensure proper installation:

- ✦ Avoid physical contact with materials that could hold static electricity such as plastic, vinyl and Styrofoam.
- ✦ Whenever you handle the card, grasp it only by its edges. DO NOT TOUCH the exposed metal pins of the connector or the electronic components.

Note:

- ✎ Keep the anti-static bag for future use. You might need the original bag to store the card if you have to remove the card from the PC or transport it elsewhere.
-

2.2 Driver Installation

We recommend you to install the driver before you install the PCI-1780 card into your system, since this will guarantee a smooth installation process.

The Advantech Device Drivers Setup program for the PCI-1780 card is included on the companion CD-ROM that is shipped with your DA&C card package. Please follow the steps below to install the driver software:

Step 1: Insert the companion CD-ROM into your CD-ROM drive.

Step 2: The Setup program will be launched automatically if you have the autoplay function enabled on your system. When the Setup Program is launched, you'll see the following Setup Screen.

Note:

- ✎ If the autoplay function is not enabled on your computer, use Windows Explorer or the Windows **Run** command to execute SETUP.EXE on the companion CD-ROM.
-



Fig. 2-1 The Setup Screen of Advantech Automation Software

Step 3: Select the *Individual Drivers* option.

Step 4: Select the specific device then just follow the installation instructions step by step to complete your device driver setup.

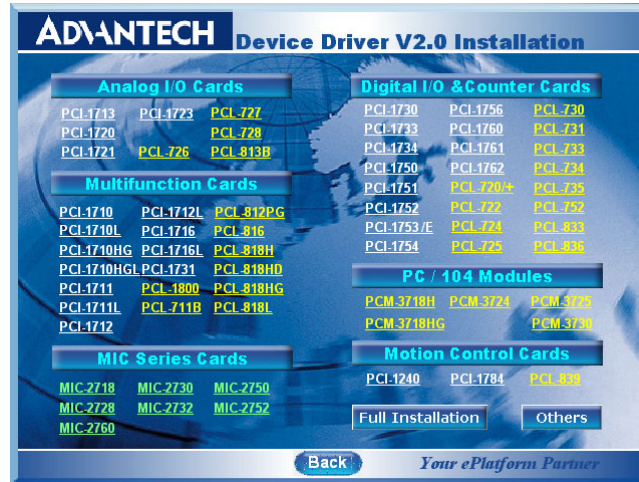

Fig. 2-2 Different options for Driver Setup

For further information on driver-related issues, an online version of *Device Drivers Manual* is available by accessing the following path:

Start/Programs/Advantech Device Drivers V2.0a/Device Driver Manual

2.3 Hardware Installation

Note:

- ✎ Make sure you have installed the driver first before you install the card (please refer to 2.2 *Driver Installation*)
-

After the DLL driver installation is completed, you can now go on to install the PCI-1780 card in any PCI slot on your computer. But it is suggested that you should refer to the computer user manual or related documentation if you have any doubt. Please follow the steps below to install the card on your system.

- Step 1:** Turn off your computer and unplug the power cord and cables. TURN OFF your computer before installing or removing any components on the computer.
- Step 2:** Remove the cover of your computer.
- Step 3:** Remove the slot cover on the back panel of your computer.
- Step 4:** Touch the metal part on the surface of your computer to neutralize the static electricity that might be on your body.
- Step 5:** Insert the PCI-1780 card into a PCI slot. Hold the card only by its edges and carefully align it with the slot. Insert the card firmly into place. Use of excessive force must be avoided, otherwise the card might be damaged.
- Step 6:** Fasten the bracket of the PCI card on the back panel rail of the computer with screws.
- Step 7:** Connect appropriate accessories (37-pin cable, wiring terminals, etc. if necessary) to the PCI card.
- Step 8:** Replace the cover of your computer chassis. Re-connect the cables you removed in step 2.
- Step 9:** Plug in the power cord and turn on the computer.

Note:

- ✎ In case you installed the card without installing the DLL driver first, Windows 95/98/ME will recognize your card as an “unknown device” after rebooting, and will prompt you to provide the necessary driver. You should ignore the prompting messages (just click the **Cancel** button) and set up the driver according to the steps described in *2.2 Driver Installation*.
-

After the PCI-1780 card is installed, you can verify whether it is properly installed on your system in the *Device Manager*:

1. Access the *Device Manager* through *Control Panel/System/Device Manager*.
2. The *device name* of the PCI-1780 should be listed on the *Device Manager* tab on the *System Property* Page.

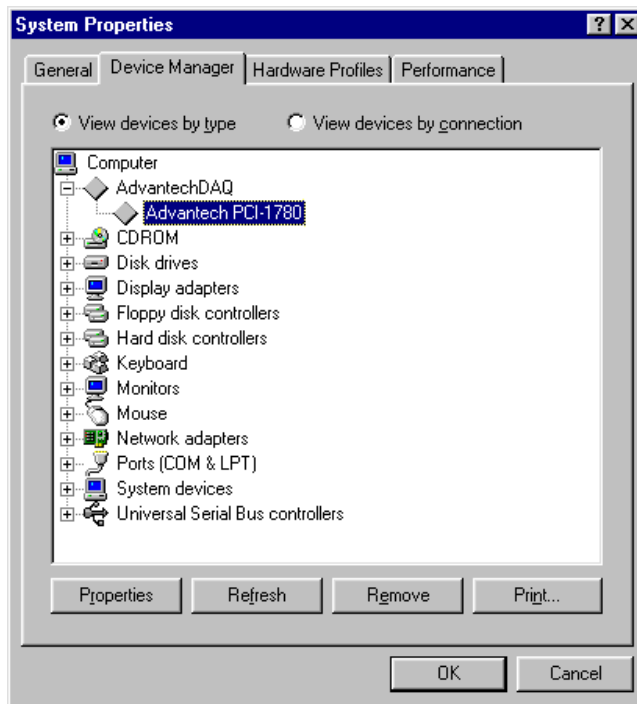

Fig. 2-3 The device name listed in the Device Manager

Note:

- ✎ If your card is properly installed, you should see the *device name* of your card listed on the *Device Manager* tab. **If you do see your device name listed on it but marked with an exclamation sign “!”, it means your card has not been correctly installed.** In this case, remove the card device from the *Device Manager* by selecting its device name and press the **Remove** button. Then go through the driver installation process again.

After your card is properly installed on your system, you can now configure your device using the *PCI-1780 Utility* program that has itself already been installed on your system during driver setup. A complete device installation procedure should include *board selection* and *device setup*. After that, you can operate this card through the *operation*. The following sections will guide you through the *board selection*, *device setup* and *operation* of your device.

2.4 Device Setup & Configuration

The *PCI-1780 Utility* program is a utility that allows you to setup, configure and test your device, and later store your settings on the system registry. These settings will be used when you call the APIs of Advantech Device Drivers.

Setting Up the Device

Step 1: To install the I/O device for your card, you must first run the *Device Manager* program (by accessing *Start/Programs/Advantech Device Drivers V2.0*).

Step 2: You can then view the device(s) already installed on your system (if any) in the *Installed Devices* list box. Since you haven't installed any device yet, you might see a blank list such as the one below (Fig. 2-4).

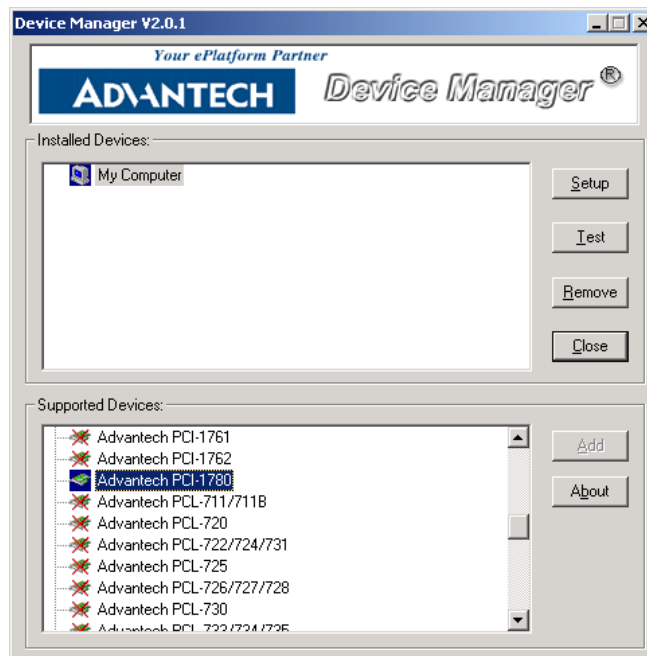

Fig. 2-4 The Device Manager dialog box

Step 3: Scroll down the *Supported Devices* box to find the device that you wish to install, then click the **Add...** button to evoke the *Existing unconfigured PCI-1780* dialog box such as one shown in Fig. 2-5. The *Existing unconfigured PCI-1780* dialog box lists all the installed devices on your system. Select the device you want to configure from the list box and press the **OK** button.

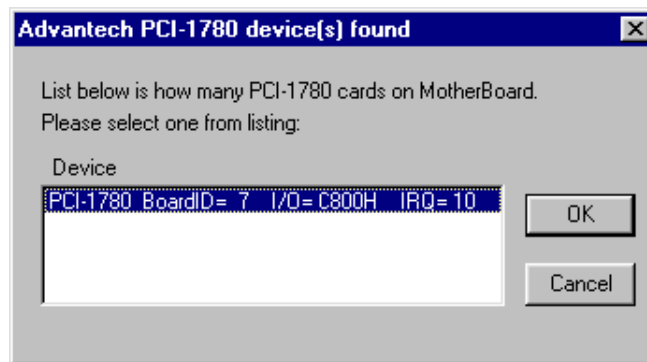

Fig. 2-5 The “Device(s) Found” dialog box

Step 4: After you have finished configuring the device, click **OK** and the *device name* will appear in the *Installed Devices* box as seen below:

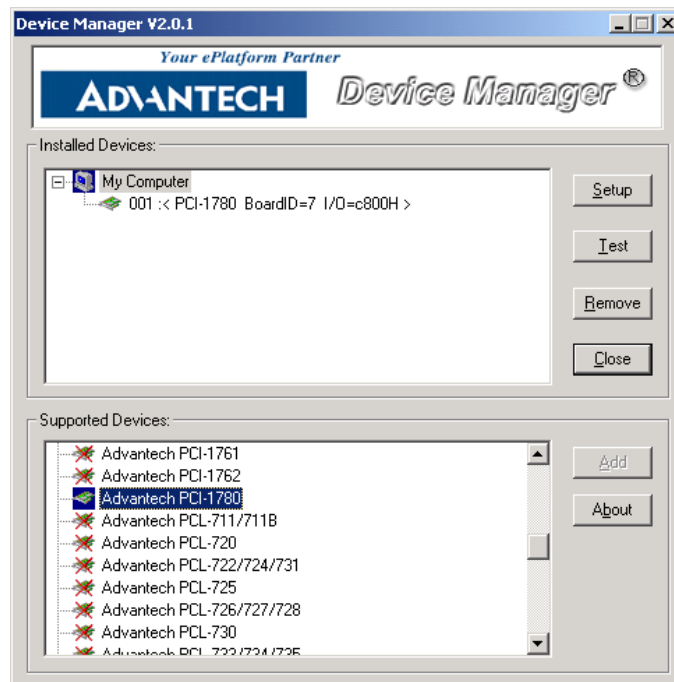

Fig. 2-6 The Device Name appearing on the list of devices box

Note:

As we have noted, the *device name* “001:<PCI-1780 BoardID=7 I/O=c800H>” begins with a *device number* “000”, which is specifically assigned to each card. The *device number* is passed to the driver to specify which device you wish to control.

After your card is properly installed and configured, you can click the **Test...** button to test your hardware by using the testing utility we supplied. For more detailed information, please refer to *Chapter 2* of the *Device Drivers Manual*.

You can also find the rich examples on the CD-ROM to speed up your programming.

3. Signal Connections

3.1 Overview

Maintaining signal connections is one of the most important factors in ensuring that your application system is sending and receiving data correctly. A good signal connection can avoid unnecessary and costly damage to your PC and other hardware devices. This chapter provides useful information about how to connect input and output signals to the PCI-1780 via the I/O connector.

3.2 Switch and Jumper Settings

The PCI-1780 card has one function switch and five jumper settings.

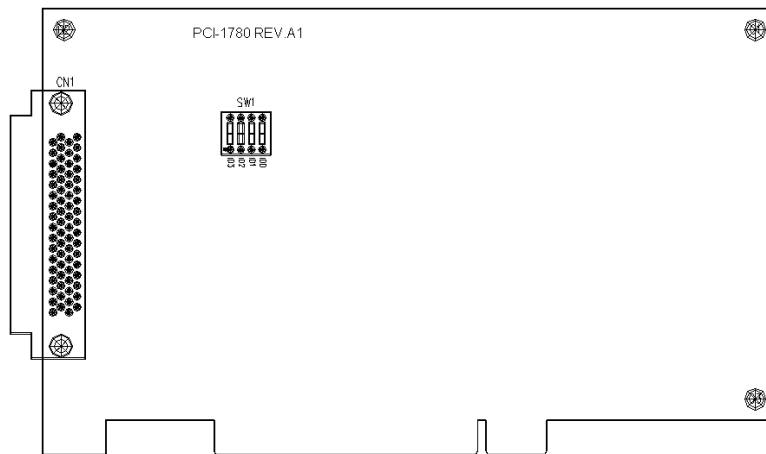

Fig. 3-1 Card connector, jumper and switch locations

Board ID setting (SW1)

ID3	ID2	ID1	ID0	Board ID
1	1	1	1	0
1	1	1	0	1
1	1	0	1	2
1	1	0	0	3
1	0	1	1	4
1	0	1	0	5
1	0	0	1	6
1	0	0	0	7
0	1	1	1	8
0	1	1	0	9
0	1	0	1	10
0	1	0	0	11
0	0	1	1	12
0	0	1	0	13
0	0	0	1	14
0	0	0	0	15

Note: On: 1, Off: 0

3.3 Signal Connections

Pin Assignment

Figure 3-2 shows the pin assignments for the 68-pin I/O connector on the PCI-1780.

GND	68	34	FOUT3
GND	67	33	FOUT2
GND	66	32	FOUT1
GND	65	31	FOUT0
GND	64	30	OUT7
GND	63	29	OUT6
GND	62	28	OUT5
GND	61	27	OUT4
GND	60	26	OUT3
GND	59	25	OUT2
GND	58	24	OUT1
GND	57	23	OUT0
DO7	56	22	DO6
DO5	55	21	DO4
DO3	54	20	DO2
DO1	53	19	DO0
+5V	52	18	+5V
DI7	51	17	DI6
DI5	50	16	DI4
DI3	49	15	DI2
DI1	48	14	DI0
GND	47	13	EXT CLK
GATE7	46	12	GATE6
GATE5	45	11	GATE4
GATE3	44	10	GATE2
GATE1	43	9	GATE0
GND	42	8	CLK7
GND	41	7	CLK6
GND	40	6	CLK5
GND	39	5	CLK4
GND	38	4	CLK3
GND	37	3	CLK2
GND	36	2	CLK1
GND	35	1	CLK0

Fig. 3-2 I/O connector pin assignments for the PCI-1780

I/O Connector Signal Description

Table 3-2 I/O connector signal descriptions

Signal Name	Reference	Direction	Description
GND	-	-	DC ground
+5V	GND	Output	+5 V_{DC} source
FOUT<0..3>	GND	Output	Frequency output channels
OUT<0..7>	GND	Output	Counter output channels
DO<0..7>	GND	Output	Digital output channels
EXT_CLK	GND	Input	External clock input
CLK<0..7>	GND	Input	Clock input channels
GATE<0..7>	GND	Input	Gate control channels
DI<0..7>	GND	Input	Digital input channels

Period measurement

This approach is a particular fit for a **low** frequency signal.

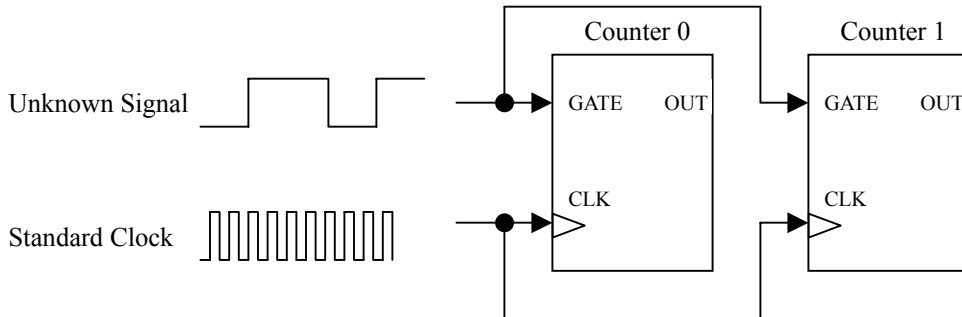

Figure 3-3: Period measurement

Implementing this measurement needs two counters. One for the up cycle period and another for the down cycle period. These added together gives the total period. The duty cycle can also be calculated by the up period being divided by the total period. Connect the unknown signal to each counter's Gate.

Apply a standard clock pulse to each counter. Counter 0 counts the up cycle. Counter 1 counts the down cycle. In PCI-1780, wiring is simple. Only connect the unknown signal to counter 0, and use the register to select the gate source. Counter 0 select the "Gate N", counter 1 select the "Gate N-1".

Apply the standard clock to both counters by clock source select register. It can change the clock for different measurement range. Counter 0 set as "Mode O" and gate polarity is positive. Counter 1 set as "Mode O" and gate polarity is negative.

Frequency measurement

This approach is a particular fit for a **high** frequency signal.

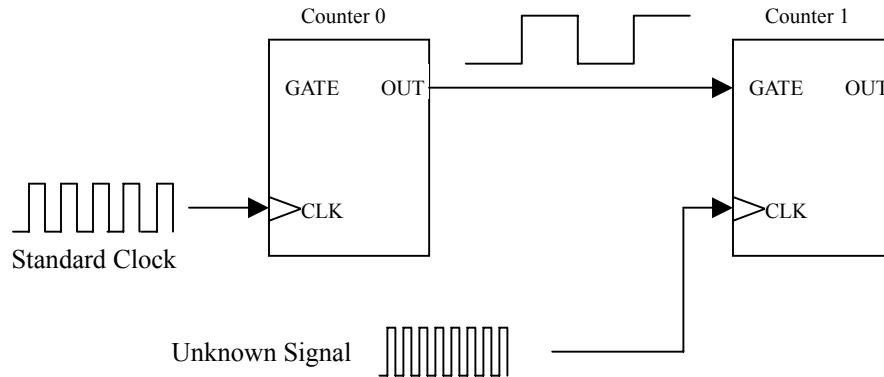

Figure 3-4: Frequency measurement

Implementing this measurement needs two counters. One for the up cycle period, another for the down cycle period. Adding them together gives the total period. The duty cycle can also be calculated by dividing the up period by the total period. Connect the unknown signal to each counter's Gate. Apply a standard clock to each counter. Counter 0 counts the up cycle. Counter 1 counts the down cycle. In PCI-1780, wiring is simple. Only connect the unknown signal to counter 0, and use the register to select the gate source. Counter 0 select the "Gate N", counter 1 select the "Gate N-1". Apply the standard clock to both counters by clock source select register. It could change the clock for different measurement range. Counter 0 set as "Mode O" and gate polarity is positive.

Appendix A. Specifications

Programmable Counter

Channels	8 (independent)
Resolution	16-bit
Programmable Clock Source	8 independent
Programmable Counter Modes	12
Max. Frequency	20 MHz
Interrupt source	8 counter outputs

Digital Input/Output

Input Channels	8	
Input Voltage	Low	0.8 V max.
	High	2.4 V min.
Interrupt source	Channel 0	
Output Channels	8	
Output Voltage	Low	0.5 V max. @ 24 mA (sink)
	High	2.4 V min. @ -15 mA (source)

General

I/O Connector Type	68-pin SCSI-II female	
Dimensions	175 mm x 100 mm (6.9" x 3.9")	
Power Consumption	Typical	+5 V @ 900 mA
	Max.	+5 V @ 1.2 A
Temperature	Operation	0 ~ 60 °C (32 ~140 °F) (refer to IEC 68-2-1,2)
	Storage	-20 ~ 70 °C (-4 ~ 158 °F)
Relative Humidity	5~95%RH non-condensing (refer to IEC 68-2-3)	
Certification	CE certified	

Appendix B. Block Diagram

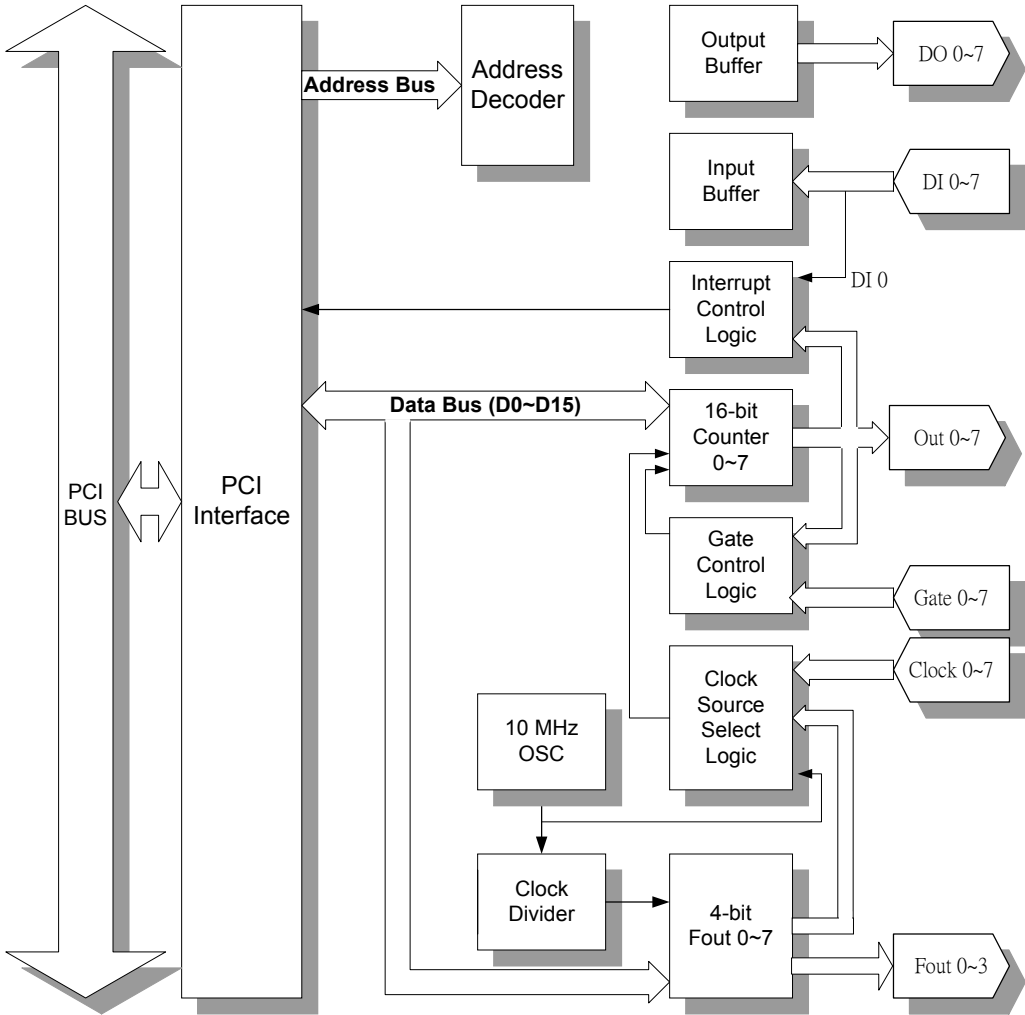

Appendix C. Register Structure and Format

C.1 Overview

The PCI-1780 is delivered with an easy-to-use 32-bit DLL driver for user programming under the Windows 2000/95/98/NT/ME/XP operating system. We advise users to program the PCI-1780 using the 32-bit DLL driver provided by Advantech to avoid the complexity of low-level programming by register.

The most important consideration in programming the PCI-1780 at register level is to understand the function of the card's registers. The information in the following sections is provided only for users who would like to do their own low-level programming.

C.2 I/O Port Address Map

The PCI-1780 requires 32 consecutive addresses in the PC's I/O space. The address of each register is specified as an offset from the card's base address. For example, BASE+0 is the card's base address and BASE+6 is the base address plus six bytes.

Table C-1 shows the function of each register of the PCI-1780 or driver and its address relative to the card's base address.

Table C-1 PCI-1780 register format (Part 1)

Base Address + HEX		PCI-1780 Register Format																
		15	14	13	12	11	10	9	8	7	6	5	4	3	2	1	0	
00H	W	Counter 0 Mode																
		CM15	CM14	CM13	CM12	CM11	CM10	CM9	CM8	CM7	CM6	CM5	CM4	CM3	CM2	CM1	CM0	
	R	N/A																
02H	W	Counter 0 Load																
		CL15	CL14	CL13	CL12	CL11	CL10	CL9	CL8	CL7	CL6	CL5	CL4	CL3	CL2	CL1	CL0	
	R	N/A																
04H	W	Counter 0 Hold																
		CH15	CH14	CH13	CH12	CH11	CH10	CH9	CH8	CH7	CH6	CH5	CH4	CH3	CH2	CH1	CH0	
	R	N/A																
06H	W															C2	C1	C0
		N/A																
	R																	
08H	W	Counter 1 Mode																
		CM15	CM14	CM13	CM12	CM11	CM10	CM9	CM8	CM7	CM6	CM5	CM4	CM3	CM2	CM1	CM0	
	R	N/A																
0AH	W	Counter 1 Load																
		CL15	CL14	CL13	CL12	CL11	CL10	CL9	CL8	CL7	CL6	CL5	CL4	CL3	CL2	CL1	CL0	
	R	N/A																
0CH	W	Counter 1 Hold																
		CH15	CH14	CH13	CH12	CH11	CH10	CH9	CH8	CH7	CH6	CH5	CH4	CH3	CH2	CH1	CH0	
	R	N/A																
0EH	W															C2	C1	C0
		N/A																
	R																	

Table C-1 PCI-1780 register format (Part 2)

Base Address + HEX		PCI-1780 Register Format															
		15	14	13	12	11	10	9	8	7	6	5	4	3	2	1	0
10H	W	Counter 2 Mode															
		CM15	CM14	CM13	CM12	CM11	CM10	CM9	CM8	CM7	CM6	CM5	CM4	CM3	CM2	CM1	CM0
10H	R	N/A															
12H	W	Counter 2 Load															
		CL15	CL14	CL13	CL12	CL11	CL10	CL9	CL8	CL7	CL6	CL5	CL4	CL3	CL2	CL1	CL0
12H	R	N/A															
14H	W	Counter 2 Hold															
		CH15	CH14	CH13	CH12	CH11	CH10	CH9	CH8	CH7	CH6	CH5	CH4	CH3	CH2	CH1	CH0
14H	R	N/A															
16H	W	Counter 2 Command															
																C2	C1
16H	R	N/A															
18H	W	Counter 3 Mode															
		CM15	CM14	CM13	CM12	CM11	CM10	CM9	CM8	CM7	CM6	CM5	CM4	CM3	CM2	CM1	CM0
18H	R	N/A															
1AH	W	Counter 3 Load															
		CL15	CL14	CL13	CL12	CL11	CL10	CL9	CL8	CL7	CL6	CL5	CL4	CL3	CL2	CL1	CL0
1AH	R	N/A															
1CH	W	Counter 3 Hold															
		CH15	CH14	CH13	CH12	CH11	CH10	CH9	CH8	CH7	CH6	CH5	CH4	CH3	CH2	CH1	CH0
1CH	R	N/A															
1EH	W	Counter 3 Command															
																C2	C1
1EH	R	N/A															

Table C-1 PCI-1780 register format (Part 3)

Base Address + HEX		PCI-1780 Register Format															
		15	14	13	12	11	10	9	8	7	6	5	4	3	2	1	0
20H	W	Counter 4 Mode															
		CM15	CM14	CM13	CM12	CM11	CM10	CM9	CM8	CM7	CM6	CM5	CM4	CM3	CM2	CM1	CM0
20H	R	N/A															
22H	W	Counter 4 Load															
		CL15	CL14	CL13	CL12	CL11	CL10	CL9	CL8	CL7	CL6	CL5	CL4	CL3	CL2	CL1	CL0
22H	R	N/A															
24H	W	Counter 4 Hold															
		CH15	CH14	CH13	CH12	CH11	CH10	CH9	CH8	CH7	CH6	CH5	CH4	CH3	CH2	CH1	CH0
24H	R	N/A															
26H	W	Counter 4 Command															
																C2	C1
26H	R	N/A															
28H	W	Counter 5 Mode															
		CM15	CM14	CM13	CM12	CM11	CM10	CM9	CM8	CM7	CM6	CM5	CM4	CM3	CM2	CM1	CM0
28H	R	N/A															
2AH	W	Counter 5 Load															
		CL15	CL14	CL13	CL12	CL11	CL10	CL9	CL8	CL7	CL6	CL5	CL4	CL3	CL2	CL1	CL0
2AH	R	N/A															
2CH	W	Counter 5 Hold															
		CH15	CH14	CH13	CH12	CH11	CH10	CH9	CH8	CH7	CH6	CH5	CH4	CH3	CH2	CH1	CH0
2CH	R	N/A															
2EH	W	Counter 5 Command															
																C2	C1
2EH	R	N/A															

Table C-1 PCI-1780 register format (Part 4)

Base Address + HEX		PCI-1780 Register Format															
		15	14	13	12	11	10	9	8	7	6	5	4	3	2	1	0
30H	W	Counter 6 Mode															
		CM15	CM14	CM13	CM12	CM11	CM10	CM9	CM8	CM7	CM6	CM5	CM4	CM3	CM2	CM1	CM0
30H	R	N/A															
32H	W	Counter 6 Load															
		CL15	CL14	CL13	CL12	CL11	CL10	CL9	CL8	CL7	CL6	CL5	CL4	CL3	CL2	CL1	CL0
32H	R	N/A															
34H	W	Counter 6 Hold															
		CH15	CH14	CH13	CH12	CH11	CH10	CH9	CH8	CH7	CH6	CH5	CH4	CH3	CH2	CH1	CH0
34H	R	N/A															
36H	W	Counter 6 Command															
																C2	C1
36H	R	N/A															
38H	W	Counter 7 Mode															
		CM15	CM14	CM13	CM12	CM11	CM10	CM9	CM8	CM7	CM6	CM5	CM4	CM3	CM2	CM1	CM0
38H	R	N/A															
3AH	W	Counter 7 Load															
		CL15	CL14	CL13	CL12	CL11	CL10	CL9	CL8	CL7	CL6	CL5	CL4	CL3	CL2	CL1	CL0
3AH	R	N/A															
3CH	W	Counter 7 Hold															
		CH15	CH14	CH13	CH12	CH11	CH10	CH9	CH8	CH7	CH6	CH5	CH4	CH3	CH2	CH1	CH0
3CH	R	N/A															
3EH	W	Counter 7 Command															
																C2	C1
3EH	R	N/A															

Table C-1 PCI-1780 register format (Part 5)

Base Address + HEX		PCI-1780 Register Format														
		15	14	13	12	11	10	9	8	7	6	5	4	3	2	1
40H	W	Command Enable														
										CE7	CE6	CE5	CE4	CE3	CE2	CE1
40H	R	N/A														
42H	W	Interrupt Control														
									DIO	C7	C6	C5	C4	C3	C2	C1
42H	R	Interrupt Status														
44H	W	Clear Interrupt														
									DIO	C7	C6	C5	C4	C3	C2	C1
44H	R	N/A														
48H	W	Digital Output														
										DO7	DO6	DO5	DO4	DO3	DO2	DO1
48H	R	Digital Input														
										DI7	DI6	DI5	DI4	DI3	DI2	DI1
4EH	W	N/A														
4EH	R	Board ID														
														BD3	BD2	BD1

Table C-1 PCI-1780 register format (Part 6)

Base Address + HEX		PCI-1780 Register Format														
		15	14	13	12	11	10	9	8	7	6	5	4	3	2	1
50H	W	FOUT 0 Control														
					FOE		FS2	FS1	FS0					DV3	DV2	DV1
50H	R	N/A														
52H	W	FOUT 1 Control														
					FOE		FS2	FS1	FS0					DV3	DV2	DV1
52H	R	N/A														
54H	W	FOUT 2 Control														
					FOE		FS2	FS1	FS0					DV3	DV2	DV1
54H	R	N/A														
56H	W	FOUT 3 Control														
					FOE		FS2	FS1	FS0					DV3	DV2	DV1
56H	R	N/A														
58H	W	FOUT 4 Control														
					FOE		FS2	FS1	FS0					DV3	DV2	DV1
58H	R	N/A														
5AH	W	FOUT 5 Control														
					FOE		FS2	FS1	FS0					DV3	DV2	DV1
5AH	R	N/A														
5CH	W	FOUT 6 Control														
					FOE		FS2	FS1	FS0					DV3	DV2	DV1
5CH	R	N/A														
5EH	W	FOUT 7 Control														
					FOE		FS2	FS1	FS0					DV3	DV2	DV1
5EH	R	N/A														

C.3 Counter 0/1/2/3/4/5/6/7 mode — BASE+00/08/10/18/20/28/30/38H

Table C-2 PCI-1780 Register for counter 0/1/2/3/4/5/6/7 mode

Base Addr.	15	14	13	12	11	10	9	8	7	6	5	4	3	2	1	0
00H	W	Counter 0 Mode														
		CM15	CM14	CM13	CM12	CM11	CM10	CM9	CM8	CM7	CM6	CM5	CM4	CM3	CM2	CM1
08H	W	Counter 1 Mode														
		CM15	CM14	CM13	CM12	CM11	CM10	CM9	CM8	CM7	CM6	CM5	CM4	CM3	CM2	CM1
10H	W	Counter 2 Mode														
		CM15	CM14	CM13	CM12	CM11	CM10	CM9	CM8	CM7	CM6	CM5	CM4	CM3	CM2	CM1
18H	W	Counter 3 Mode														
		CM15	CM14	CM13	CM12	CM11	CM10	CM9	CM8	CM7	CM6	CM5	CM4	CM3	CM2	CM1
20H	W	Counter 4 Mode														
		CM15	CM14	CM13	CM12	CM11	CM10	CM9	CM8	CM7	CM6	CM5	CM4	CM3	CM2	CM1
28H	W	Counter 5 Mode														
		CM15	CM14	CM13	CM12	CM11	CM10	CM9	CM8	CM7	CM6	CM5	CM4	CM3	CM2	CM1
30H	W	Counter 6 Mode														
		CM15	CM14	CM13	CM12	CM11	CM10	CM9	CM8	CM7	CM6	CM5	CM4	CM3	CM2	CM1
38H	W	Counter 7 Mode														
		CM15	CM14	CM13	CM12	CM11	CM10	CM9	CM8	CM7	CM6	CM5	CM4	CM3	CM2	CM1

- CM1 ~ CM0** **Output control**
- 00** Active high terminal count pulse
 - 01** Active low terminal count pulse
 - 10** TC toggled from low
 - 11** TC toggled from high
- CM2** **Output enable control**
- 0** Disable (high impedance)
 - 1** Enabled
- CM3** **Count control (up/down)**
- 0** Count down
 - 1** Count up
- CM4** **Count control (once/repetitively)**
- 0** Count Once
 - 1** Count Repetitively

CM5	Count control (reload)
0	Reload from LOAD register
1	Reload from LOAD or HOLD register
CM6	Count control (special gate)
0	Disable special gate
1	Enable special gate
CM7	Count control (special gate)
0	Count on rising edge
1	Count on falling edge
CM11 ~ CM8	Count source selection
0000	Internal clock
0001	OUT N-1
0010	CLK N
0011	CLK N-1
0100	FOUT 0
0101	FOUT 1
0110	FOUT 2
0111	FOUT 3
1000	FOUT 4
1001	FOUT 5
1010	FOUT 6
1011	FOUT 7
1100	GATE N-1
1101	N/A
1110	N/A
1111	N/A
CM13 ~ CM12	Gate source selection
00	No gating
01	OUT N-1
10	GATE N
11	GATE N-1

CM14**Gating polarity selection**

0 High level for level active, rising edge for edge active

1 Low level for level active, falling edge for edge active

CM15**Gate active edge or level**

0 Level active

1 Edge active

C.4 Counter 0/1/2/3/4/5/6/7 load — BASE+02/0A/12/1A/22/2A/32/3AH

Table C-3 PCI-1780 Register for counter 0/1/2/3/4/5/6/7 load

Base Addr.		15	14	13	12	11	10	9	8	7	6	5	4	3	2	1	0
02H	W	Counter 0 Load															
		CL15	CL14	CL13	CL12	CL11	CL10	CL9	CL8	CL7	CL6	CL5	CL4	CL3	CL2	CL1	CL0
0AH	W	Counter 1 Load															
		CL15	CL14	CL13	CL12	CL11	CL10	CL9	CL8	CL7	CL6	CL5	CL4	CL3	CL2	CL1	CL0
12H	W	Counter 2 Load															
		CL15	CL14	CL13	CL12	CL11	CL10	CL9	CL8	CL7	CL6	CL5	CL4	CL3	CL2	CL1	CL0
1AH	W	Counter 3 Load															
		CL15	CL14	CL13	CL12	CL11	CL10	CL9	CL8	CL7	CL6	CL5	CL4	CL3	CL2	CL1	CL0
22H	W	Counter 4 Load															
		CL15	CL14	CL13	CL12	CL11	CL10	CL9	CL8	CL7	CL6	CL5	CL4	CL3	CL2	CL1	CL0
2AH	W	Counter 5 Load															
		CL15	CL14	CL13	CL12	CL11	CL10	CL9	CL8	CL7	CL6	CL5	CL4	CL3	CL2	CL1	CL0
32H	W	Counter 6 Load															
		CL15	CL14	CL13	CL12	CL11	CL10	CL9	CL8	CL7	CL6	CL5	CL4	CL3	CL2	CL1	CL0
3AH	W	Counter 7 Load															
		CL15	CL14	CL13	CL12	CL11	CL10	CL9	CL8	CL7	CL6	CL5	CL4	CL3	CL2	CL1	CL0

CL15 ~ CL0 Counter load data

C.5 Counter 0/1/2/3/4/5/6/7 hold — BASE+04/0C/14/1C/24/2C/34/3CH

Table C-4 PCI-1780 Register for counter 0/1/2/3/4/5/6/7 hold

Base Addr.		15	14	13	12	11	10	9	8	7	6	5	4	3	2	1	0
04H	W	Counter 0 Hold															
		CH15	CH14	CH13	CH12	CH11	CH10	CH9	CH8	CH7	CH6	CH5	CH4	CH3	CH2	CH1	CH0
0CH	W	Counter 1 Hold															
		CH15	CH14	CH13	CH12	CH11	CH10	CH9	CH8	CH7	CH6	CH5	CH4	CH3	CH2	CH1	CH0
14H	W	Counter 2 Hold															
		CH15	CH14	CH13	CH12	CH11	CH10	CH9	CH8	CH7	CH6	CH5	CH4	CH3	CH2	CH1	CH0
1CH	W	Counter 3 Hold															
		CH15	CH14	CH13	CH12	CH11	CH10	CH9	CH8	CH7	CH6	CH5	CH4	CH3	CH2	CH1	CH0
24H	W	Counter 4 Hold															
		CH15	CH14	CH13	CH12	CH11	CH10	CH9	CH8	CH7	CH6	CH5	CH4	CH3	CH2	CH1	CH0
2CH	W	Counter 5 Hold															
		CH15	CH14	CH13	CH12	CH11	CH10	CH9	CH8	CH7	CH6	CH5	CH4	CH3	CH2	CH1	CH0
34H	W	Counter 6 Hold															
		CH15	CH14	CH13	CH12	CH11	CH10	CH9	CH8	CH7	CH6	CH5	CH4	CH3	CH2	CH1	CH0
3CH	W	Counter 7 Hold															
		CH15	CH14	CH13	CH12	CH11	CH10	CH9	CH8	CH7	CH6	CH5	CH4	CH3	CH2	CH1	CH0

CH15 ~ CH0 Counter hold data

C.6 Counter 0/1/2/3/4/5/6/7 command — BASE+06/0E/16/1E/26/2E/36/3EH

Table C-5 PCI-1780 Register for counter 0/1/2/3/4/5/6/7 command

Base Addr.	15	14	13	12	11	10	9	8	7	6	5	4	3	2	1	0
06H	W	Counter 0 Command														
																C2
0EH	W	Counter 1 Command														
																C2
16H	W	Counter 2 Command														
																C2
1EH	W	Counter 3 Command														
																C2
26H	W	Counter 4 Command														
																C2
2EH	W	Counter 5 Command														
																C2
36H	W	Counter 6 Command														
																C2
3EH	W	Counter 7 Command														
																C2

C2 ~ C0

Command code

- 000** Disarm counter
- 001** Load counter from LOAD
- 010** Disarm and save counter
- 011** Step counter
- 100** Arm counter
- 101** Load counter Arm counter
- 110** Save counter to HOLD
- 111** Reset counter

C.7 Command enable — BASE+40H

Table C-6 PCI-1780 Register for command enable

Base Addr.		15	14	13	12	11	10	9	8	7	6	5	4	3	2	1	0
40H	W	Command enable															
											CE7	CE6	CE5	CE4	CE3	CE2	CE1

CE n **Counter command enable bit (n : 0 ~ 7)**

0 Don't select this counter

1 Select the counter

C.8 Interrupt control — BASE+42H

Table C-7 PCI-1780 Register for interrupt control

Base Addr.		15	14	13	12	11	10	9	8	7	6	5	4	3	2	1	0
42H	W	Interrupt control															
										DI0	C7	C6	C5	C4	C3	C2	C1

- C_n** **Counter interrupt enable bit (n: 0 ~ 7)**
0 Disable interrupt for this counter
1 Enable interrupt for this counter
- DI0** **Interrupt enable bit**
0 Disable interrupt for DI0
1 Enable interrupt for DI0

C.9 Interrupt status — BASE+42H

Table C-8 PCI-1780 Register for interrupt status

Base Addr.		15	14	13	12	11	10	9	8	7	6	5	4	3	2	1	0
42H	R	Interrupt control															
										DI0	C7	C6	C5	C4	C3	C2	C1

- C_n** **Counter interrupt status bit (n: 0 ~ 7)**
0 No interrupt occurred
1 Interrupt occurred
- DI0** **Interrupt status bit**
0 No interrupt occurred form DI0
1 Interrupt occurred form DI0

C.10 Clear interrupt — BASE+44H

Write any data to these two bytes to clear the interrupt.

Table C-9 PCI-1780 Register for clear interrupt

Base Addr.		15	14	13	12	11	10	9	8	7	6	5	4	3	2	1	0
44H	W	Clear interrupt															

C.11 Digital output — BASE+48H

Table C-10 PCI-1780 Register for digital output

Base Addr.		15	14	13	12	11	10	9	8	7	6	5	4	3	2	1	0
48H	W	Digital output															
											DO7	DO6	DO5	DO4	DO3	DO2	DO1

C.12 Digital input — BASE+48H

Table C-11 PCI-1780 Register for digital input

Base Addr.		15	14	13	12	11	10	9	8	7	6	5	4	3	2	1	0
48H	R	Digital input															
											DI7	DI6	DI5	DI4	DI3	DI2	DI1

C.13 Board ID — BASE+4EH

The PCI-1780 offers Board ID register BASE+4EH. With correct Board ID settings, users can easily identify and access each card during hardware configuration and software programming.

Table C-12 PCI-1780 Register for board ID

Base Addr.		15	14	13	12	11	10	9	8	7	6	5	4	3	2	1	0
4EH	R	Board ID															
																BD3	BD2

BD3 ~ DB0

Board ID

BD0 LSB of the Board ID

BD3 MSB of the Board ID

BD3	BD2	BD1	BD0	Board ID
1	1	1	1	15
1	1	1	0	14
1	1	0	1	13
1	1	0	0	12
1	0	1	1	11
1	0	1	0	10
1	0	0	1	9
1	0	0	0	8
0	1	1	1	7
0	1	1	0	6
0	1	0	1	5
0	1	0	0	4
0	0	1	1	3
0	0	1	0	2
0	0	0	1	1
0	0	0	0	0

C.14 FOUT 0/1/2/3/4/5/6/7 control — BASE + 50~5FH

Table C-13 PCI-1780 Register for FOUT 0/1/2/3/4/5/6/7 Control

Base Addr.		15	14	13	12	11	10	9	8	7	6	5	4	3	2	1	0
50H	W	FOUT 0 Control															
					FOE		FS2	FS1	FS0						DV3	DV2	DV1
52H	W	FOUT 1 Control															
					FOE		FS2	FS1	FS0						DV3	DV2	DV1
54H	W	FOUT 2 Control															
					FOE		FS2	FS1	FS0						DV3	DV2	DV1
56H	W	FOUT 3 Control															
					FOE		FS2	FS1	FS0						DV3	DV2	DV1
58H	W	FOUT 4 Control															
					FOE		FS2	FS1	FS0						DV3	DV2	DV1
5AH	W	FOUT 5 Control															
					FOE		FS2	FS1	FS0						DV3	DV2	DV1
5CH	W	FOUT 6 Control															
					FOE		FS2	FS1	FS0						DV3	DV2	DV1
5EH	W	FOUT 7 Control															
					FOE		FS2	FS1	FS0						DV3	DV2	DV1

DV3 ~ DV0

FOUT divider

0000	Divide by 1
0001	Divide by 2
0010	Divide by 3
0011	Divide by 4
0100	Divide by 5
0101	Divide by 6
0110	Divide by 7
0111	Divide by 8
1000	Divide by 9
1001	Divide by 10
1010	Divide by 11
1011	Divide by 12
1100	Divide by 13
1101	Divide by 14
1110	Divide by 15
1111	Divide by 16

FS2 ~ FS0	FOUT source
	000 External clock
	001 CLK N
	010 FOUT N-1
	011 10 MHz clock
	100 1 MHz clock
	101 100 KHz clock
	110 10 KHz clock
	111 1 KHz clock
FOE	FOUT output enable
	0 Disable
	1 Enable

Appendix D. Waveform of each mode

The PCI-1780 offers 16 powerful counter functions to fulfill your industrial or laboratory applications. This chapter will describe each mode in detail with the waveform diagram.

Counter mode descriptions

Counter Mode register bits CM15-CM12 and CM6-CM4 select the operating mode for each counter (see Table D-1). To simplify references to a particular mode, each mode is assigned a letter from **A** through **X**. Representative waveforms for the counter modes are illustrated in Figure **A** through **X** (because the letter suffix in the figure number is keyed to the mode, Figures **M**, **N**, **P**, **Q**, **V**, **W** do not exist).

The figures assume counting on rising source edges. Those modes, which automatically disarm the counter ($CM4 = 0$) are shown with the WR pulse entering the required ARM command; for modes which count repetitively ($CM4 = 1$) the ARM command is omitted. Both a TC output waveform and a TC Toggled output waveform are shown for each mode.

The symbols **L** and **H** are used to represent count values equal to the **Load** and **Hold** register contents, respectively. The symbols **K** and **N** represent arbitrary count values. For each mode, the required bit pattern in the Counter Mode register is shown; "don't care" bits are marked "X". These figures are designed to clarify the mode descriptions.

To keep the following mode descriptions concise and to the point, the phrase "source edges" is used to refer to active-going source edges only, not to inactive-going edges. Similarly, the phrase "gate edges" refers only to active-going gate edges. Also, again to avoid verbosity and euphuism, the descriptions of some modes state that a counter is stopped or disarmed "on a TC, inhibiting further counting."

As is fully explained in the TC section of the document, for these modes the counter is actually stopped or disarmed following the active-going source edge which drives the counter out of TC. In other words, since a counter in the TC state always counts, irrespective of it's gating of arming status, the stopping or disarming of the count sequence is delayed until TC is terminated.

Counter mode table:

(N: No gate control, L: Level gate control, E: Edge gate control)

Table D-1 PCI-1780 counter mode

Counter Mode	A	B	C	D	E	F	G	H	I	J	K	L
Special Gate (CM6)	0	0	0	0	0	0	0	0	0	0	0	0
Reload Source (CM5)	0	0	0	0	0	0	1	1	1	1	1	1
Repetition (CM4)	0	0	0	1	1	1	0	0	0	1	1	1
Gate Control (CM15~CM12)	N	L	E	N	L	E	N	L	E	N	L	E
Count to TC once, then disarm	✓	✓	✓									
Count to TC twice, then disarm							✓	✓	✓			
Count to TC repeatedly without disarming				✓	✓	✓				✓	✓	✓
Gate input dose not gate counter input	✓			✓			✓			✓		
Count only during active gate level		✓			✓			✓			✓	
Start count on active gate edge and stop count on next TC			✓			✓						
Start count on active gate edge and stop count on second TC									✓			✓
Start count on active gate edge and stop count on inactive gate edge												
Reload counter from Load Register on TC	✓	✓	✓	✓	✓	✓						
Reload counter on each TC, alternating reload source between Load and Hold Registers							✓	✓	✓	✓	✓	✓

Counter Mode	M	N	O	P	Q	R	S	T	U	V	W	X
Special Gate (CM6)	1	1	1	1	1	1	1	1	1	1	1	1
Reload Source (CM5)	0	0	0	0	0	0	1	1	1	1	1	1
Repetition (CM4)	0	0	0	1	1	1	0	0	0	1	1	1
Gate Control (CM15~CM12)	N	L	E	N	L	E	N	L	E	N	L	E
Count to TC once, then disarm	✓	✓	✓									
Count to TC twice, then disarm							✓	✓	✓			
Count to TC repeatedly without disarming				✓	✓	✓				✓	✓	✓
Gate input dose not gate counter input	✓			✓			✓			✓		
Count only during active gate level		✓			✓			✓			✓	
Start count on active gate edge and stop count on next TC			✓			✓						
Start count on active gate edge and stop count on second TC									✓			✓
Start count on active gate edge and stop count on inactive gate edge			✓			✓			✓			✓
Reload counter from Load Register on TC	✓	✓	✓	✓	✓	✓						
Reload counter on each TC, alternating reload source between Load and Hold Registers							✓	✓	✓	✓	✓	✓

Note: Counter modes M, N, P, Q, S, T, V, W are identical to A, B, D, E, G, H, J, K.

D.1 Mode A waveform

Software-Triggered Strobe with No Hardware Gating

Mode A is one of the simplest operating modes. The counter will be available for countering source edges when it is issued and ARM command. On each TC the counter will reload from the **Load** register and automatically disarm itself, inhibiting further counting. Counting will resume when a new ARM command is issued.

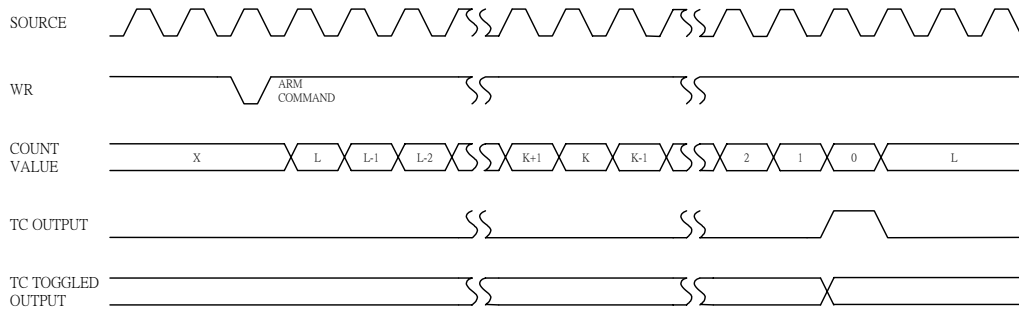

Mode A Waveforms

D.2 Mode B waveform

Software-Triggered Strobe with Level Gating

Mode B is identical to Mode A except that source edges are counted only when the assigned Gate is active. The counter must be armed before counting can occur. Once armed, the counter will count all source edges that occur while the Gate is active and disregard those edges which occur while the Gate is inactive.

This permits the Gate to turn the count process on and off. On each TC the counter will reload from the **Load** register and automatically disarm itself, inhibiting further counting until a new ARM command is issued.

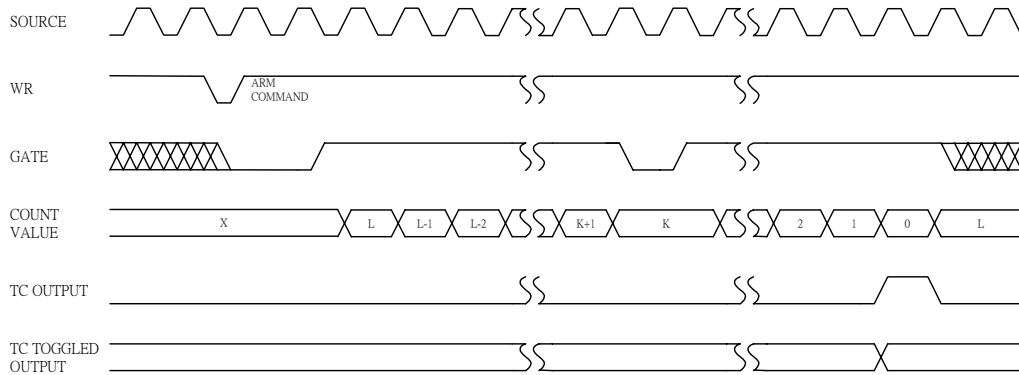

Mode B Waveforms

D.3 Mode C waveform

Hardware-Triggered Strobe

Mode C is identical to Mode A, except that counting will not begin until a Gate edge is applied to the armed counter, the counter must be armed before application of the triggering Gate edge; Gate edges applied to a disarmed counter are disregarded.

The counter will start counting on the first source edge after the triggering Gate edge and will continue counting until TC. At TC, the counter will reload from the **Load** register and automatically disarm itself. Counting will then remain inhibited until a new ARM command and a new Gate edge are applied in that order.

Note that after application of a triggering Gate edge, The Gate input will be disregarded for the remainder of the count cycle. This differs from Mode B, where the Gate can be modulated throughout the count cycle to stop and start the counter.

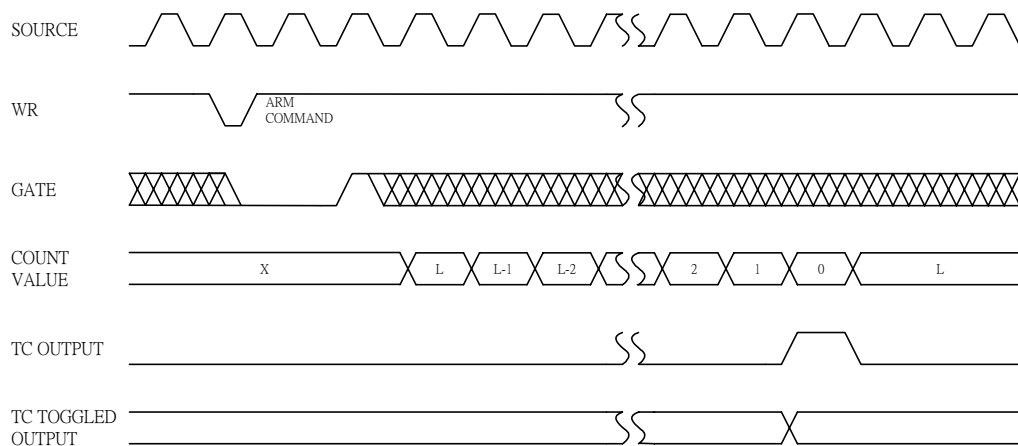

Mode C Waveforms

D.4 Mode D waveform

Rate Generator with No Hardware Gating

Mode D is typically used in frequency generation applications. In this mode, the Gate input does not affect counter operation. Once armed, the counter will count to TC repetitively. On each TC the counter will reload itself from the **Load** register; hence the **Load** register value determines the time between TCs. A square wave rate generator may be obtained by specifying the TC Toggled output mode in the Counter Mode register.

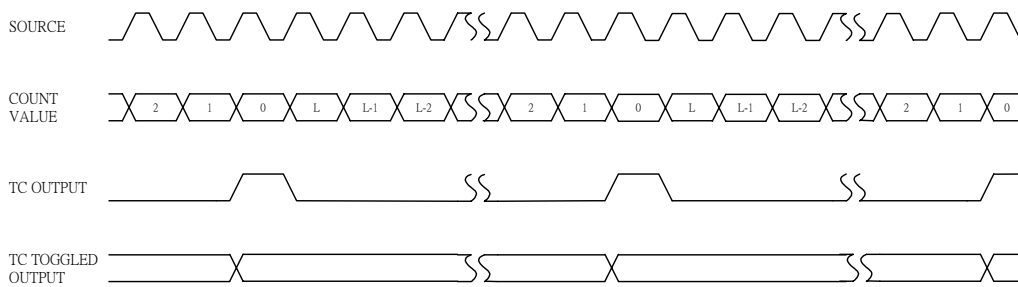

Mode D Waveforms

D.5 Mode E waveform

Rate Generator with Level Gating

Mode E is identical to Mode D, except the counter will only count those source edges that occur while the Gate input is active. This feature allows the counting process to be enabled and disabled under hardware control. A square wave rate generator may be obtained by specifying the TC Toggled output mode.

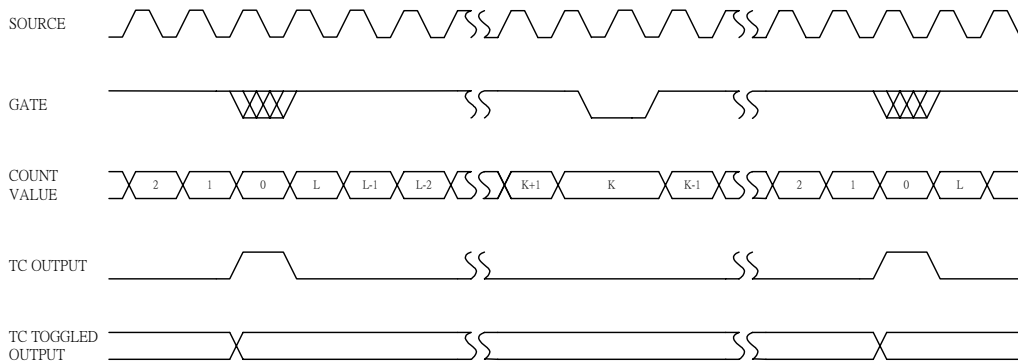

Mode E Waveforms

D.6 Mode F waveform

Non-Retriggerable One-Shot

Mode F provides a non-retriggerable one-shot timing function. The counter must be armed before it will function. Application of a Gate edge to the armed counter will enable counting. When the counter reaches TC, it will reload itself from the **Load** register. The counter will then stop counting, awaiting a new Gate edge.

Note that unlike Mode C, a new ARM command is not needed after TC, only a new Gate edge. After application of a triggering Gate edge, the Gate input is disregarded until TC.

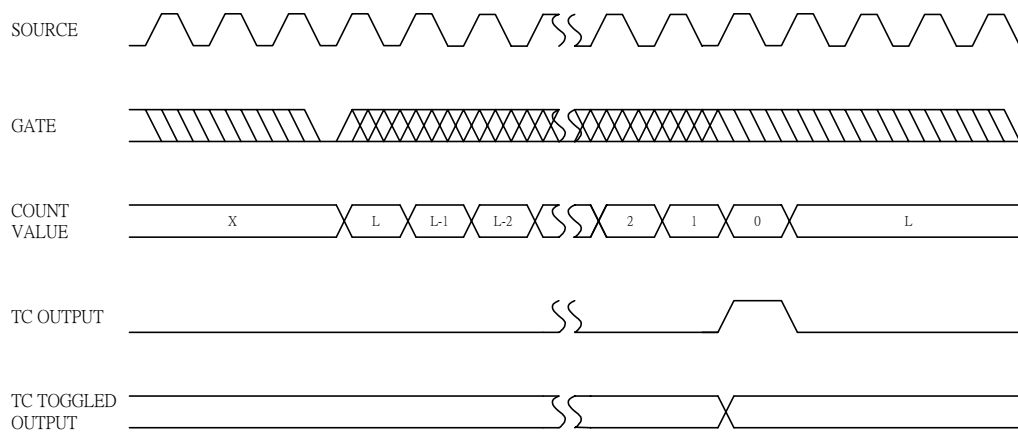

Mode F Waveforms

D.7 Mode G waveform

Software-Triggered Delayed Pulse One-Shot

In Mode G, the Gate does not affect the counter's operation. Once armed, the counter will count to TC twice and then automatically disarm itself. For most applications, the counter will initially be loaded from the **Load** register either by a LOAD command or by the last TC of an earlier timing cycle.

Upon counting to the first TC, the counter will reload itself from the **Hold** register. Counting will proceed until the second TC, when the counter will reload itself from the **Load** register and automatically disarm itself, inhibiting further counting. Counting can be resumed by issuing a new ARM command.

Specifying the TC Toggled output mode in the Counter Mode register may generate a software-triggered delayed pulse one-shot. The initial counter contents control the delay from the ARM command until the output pulse starts. The **Hold** register contents control the pulse duration.

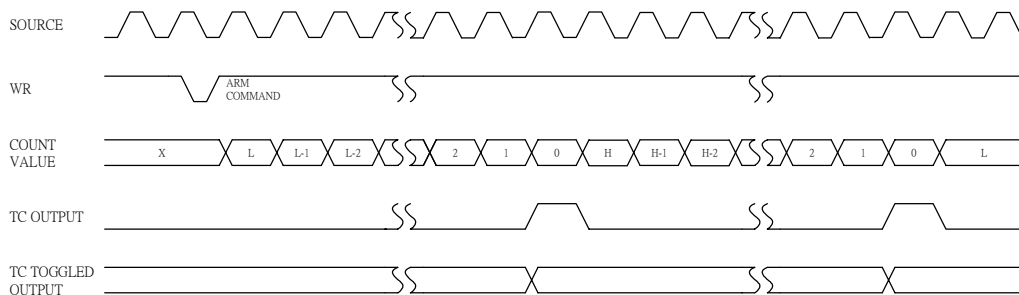

Mode G Waveforms

D.8 Mode H waveform

Software-Triggerred Delayed Pulse One-Shot with Hardware Gating

Mode H is identical to Mode G except that the Gate input is used to qualify which source edges are to be counted. The counter must be armed for counting to occur. Once armed, the counter will count all source edges that occur while the Gate is active and disregard those source edges that occur while the Gate is inactive. This permits the Gate to turn the count process on and off.

As with Mode G, the counter will be reloaded from the **Hold** register on the first TC and reloaded from the **Load** register and disarmed on the second TC. This mode allows the Gate to control the extension of both the initial output delay time and the pulse width.

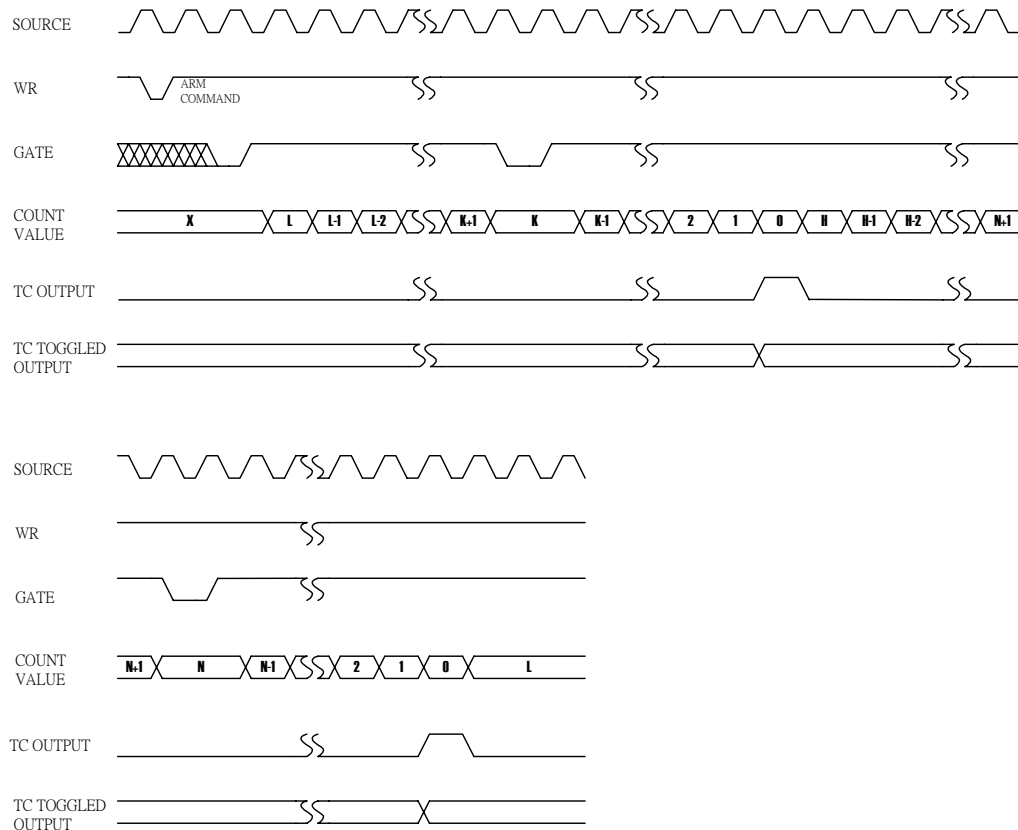

Mode H Waveforms

D.9 Mode I waveform

Hardware-Triggered Delayed Pulse Strobe

Mode I is identical to Mode G, except the counting will not begin until a Gate edge is applied to an armed counter. The counter must be armed before application of the triggering Gate edge; Gate edges applied to a disarmed counter are disregarded. An armed counter will start counting on the first source edge after the triggering Gate edge. Counting will then proceed in the same manner as in Mode G. After the second TC, the counter will disarm itself. An ARM command and Gate edge must be issued in this order to restart counting.

Note that after application of a triggering Gate edge, the Gate input will be disregarded until the second TC. This differs from Mode H, where the Gate can be modulated throughout the count cycle to stop and start the counter.

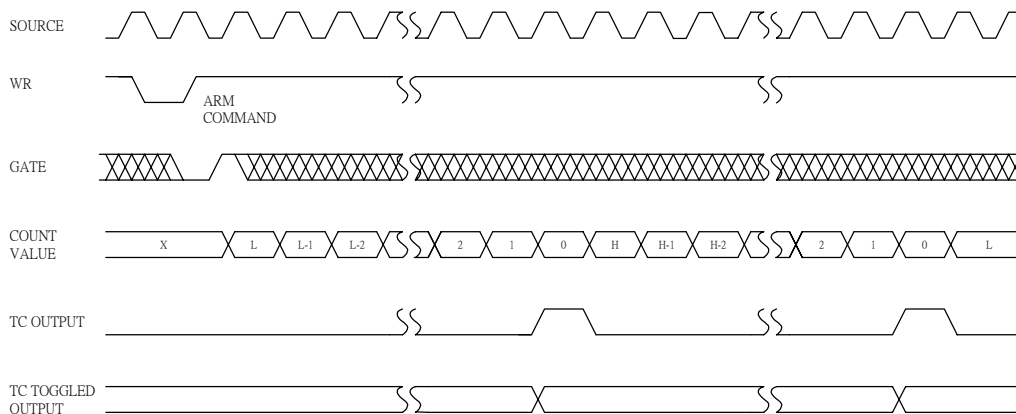

Mode I Waveforms

D.10 Mode J waveform

Variable Duty Cycle Rate Generator with No Hardware Gating

Mode J will find the greatest usage in frequency generation applications with variable duty cycle requirements. Once armed, the counter will count continuously until it is issued a DISARM command.

On the first TC, the counter will be reloaded from the **Hold** register. Counting will then proceed until the second TC at which time the counter will be reloaded from the **Load** register. Counting will continue, with the reload source alternating on each TC, until a DISARM command is issued to the counter. (The third TC reloads from the **Hold** register, the fourth TC reloads from the **Load** register, etc.)

Specifying the TC Toggled output in the Counter Mode register can generate a variable duty cycle output. The **Load** and **Hold** values then directly control the output duty cycle, with high resolution available when relatively high count values are used.

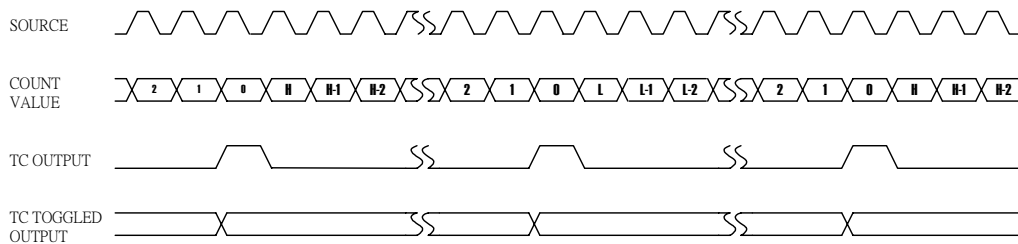

Mode J Waveforms

D.11 Mode K waveform

Variable Duty Cycle Rate Generator with Level Gating

Mode K is identical to Mode J except that source edges are only counted when the Gate is active. The counter must be armed for counting to occur. Once armed, the counter will count all source edges that occur while the Gate is active and disregard those source edges that occur while the Gate is inactive. This permits the Gate to turn the count process on and off.

As with Mode J, the reload source used will alternate on each TC, starting with the **Hold** register on the first TC after any allows the Gate to modulate the duty cycle of the output waveform. It can affect both the high and low portions of the output waveform.

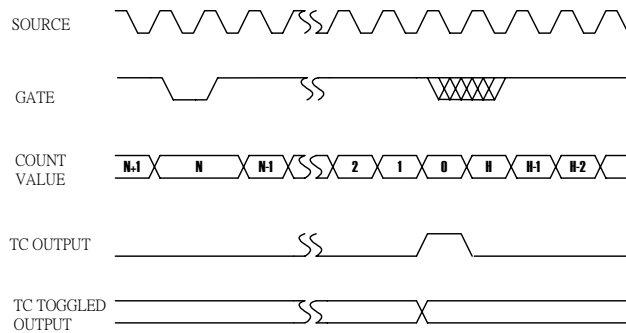
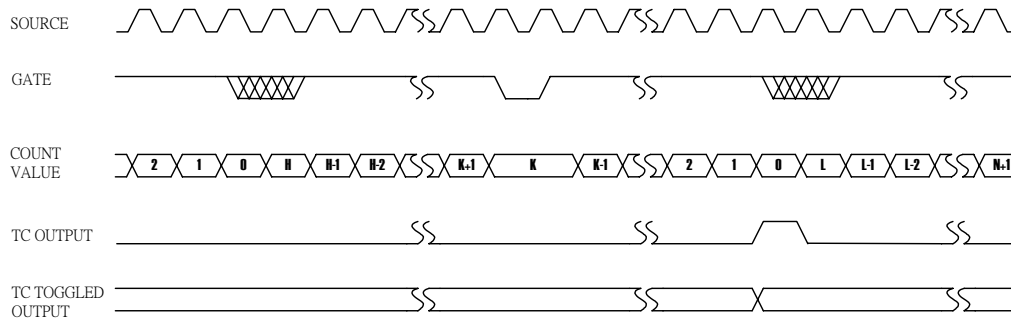

Mode K Waveforms

D.12 Mode L waveform

Hardware-Triggered Delayed Pulse One-Shot

Mode L is similar to Mode J except that counting will not begin until a Gate edge is applied to an armed counter. The counter must be armed before application of the triggering Gate edge; Gate edges applied to a disarmed counter are disregarded. The counter will start counting source edges and counting will proceed until the second TC.

Note that after application of a triggering Gate edge, the Gate input will be disregarded for the remainder of the count cycle. This differs from Mode K, where the gate can be modulated throughout the count cycle to stop and start the counter. On the first TC after application of the triggering Gate edge, the counter will be reloaded from the **Hold** register. On the second TC, the counter will be reloaded from the **Load** register and counting will stop until a new edge is issued to the counter. Note that unlike Mode K, new Gate edges are required after every second TC to continue counting.

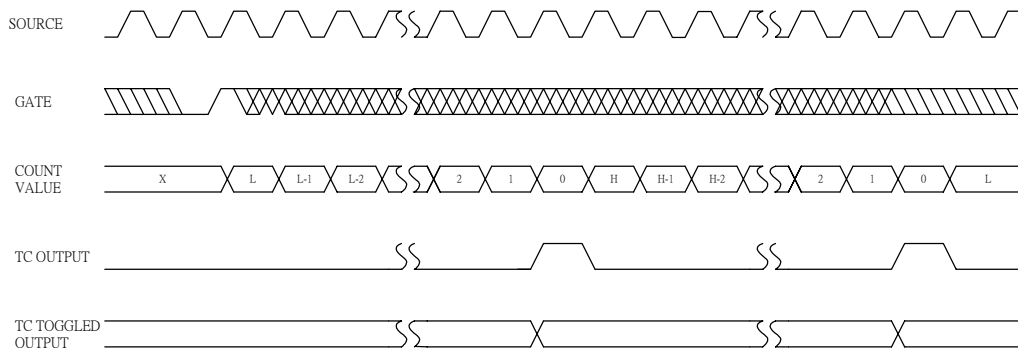

Mode L Waveforms

D.13 Mode O waveform

Hardware-Triggered Strobe with Edge Disarm

Mode O, shown in Figure O, is identical to Mode C except that the counter will be disarmed while an inactive-going Gate edge is applied to the counter. And the counter will hold the count value until it is issued a LOAD command or REST command.

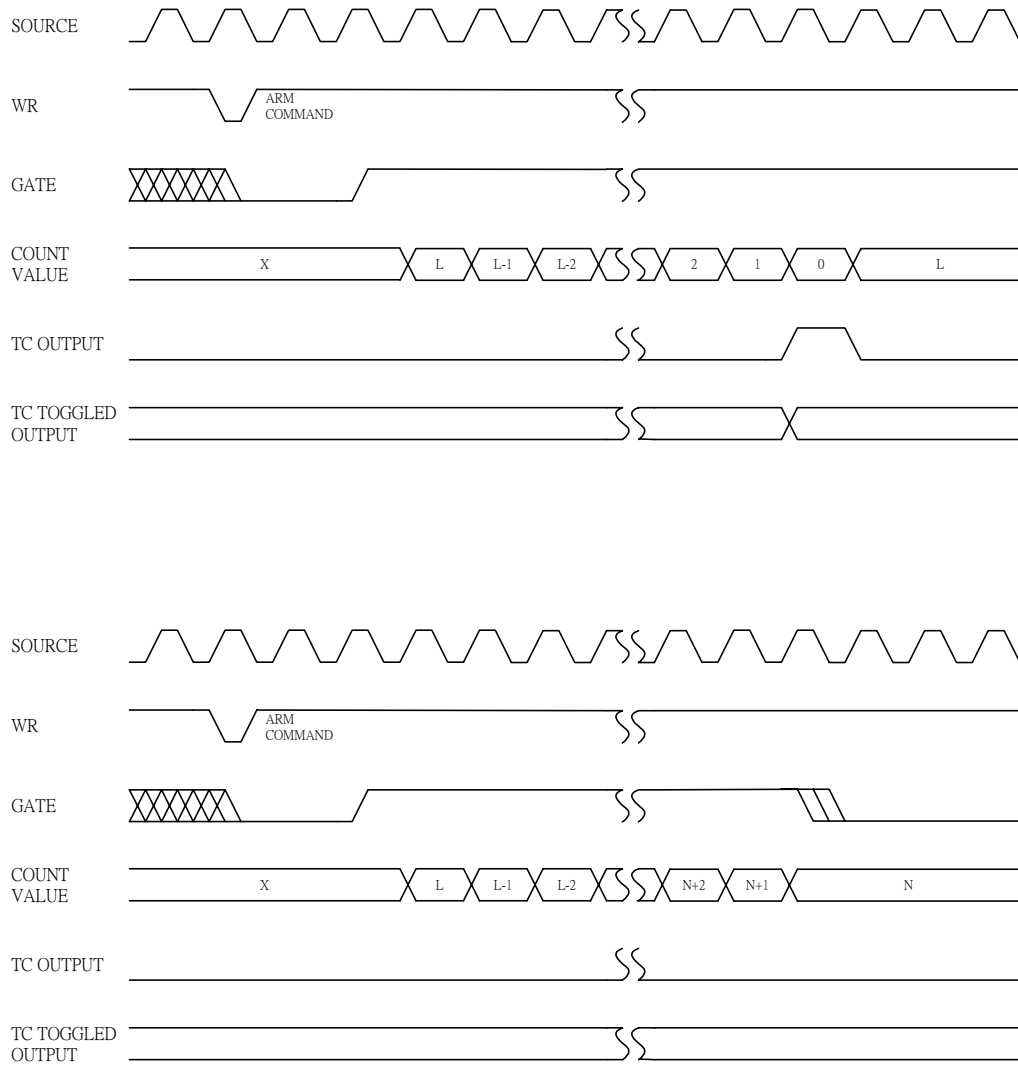

Mode O Waveforms

D.14 Mode R waveform

Non-Retriggerable One-Shot with Edge Disarm

Mode R is identical to Mode F except that the counter will be disarmed while an inactive-going Gate edge is applied to the counter. And the counter will hold the count value until it is issued a LOAD command or REST command.

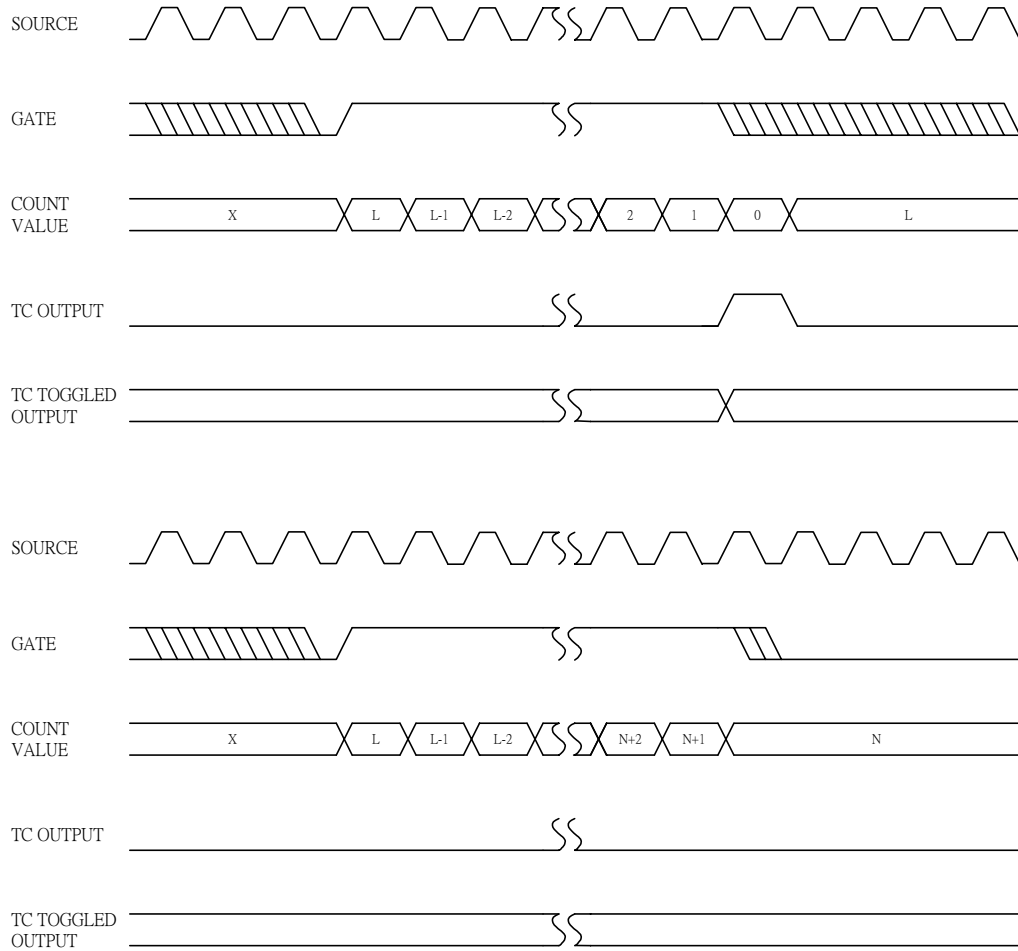

Mode R Waveforms

D.15 Mode U waveform

Hardware-Triggered Delayed Pulse Strobe with Edge Disarm

Mode U is identical to Mode I except that the counter will be disarmed while the Gate an inactive-going Gate edge is applied to the counter. And the counter will hold the count value until it is issued a LOAD command or REST command.

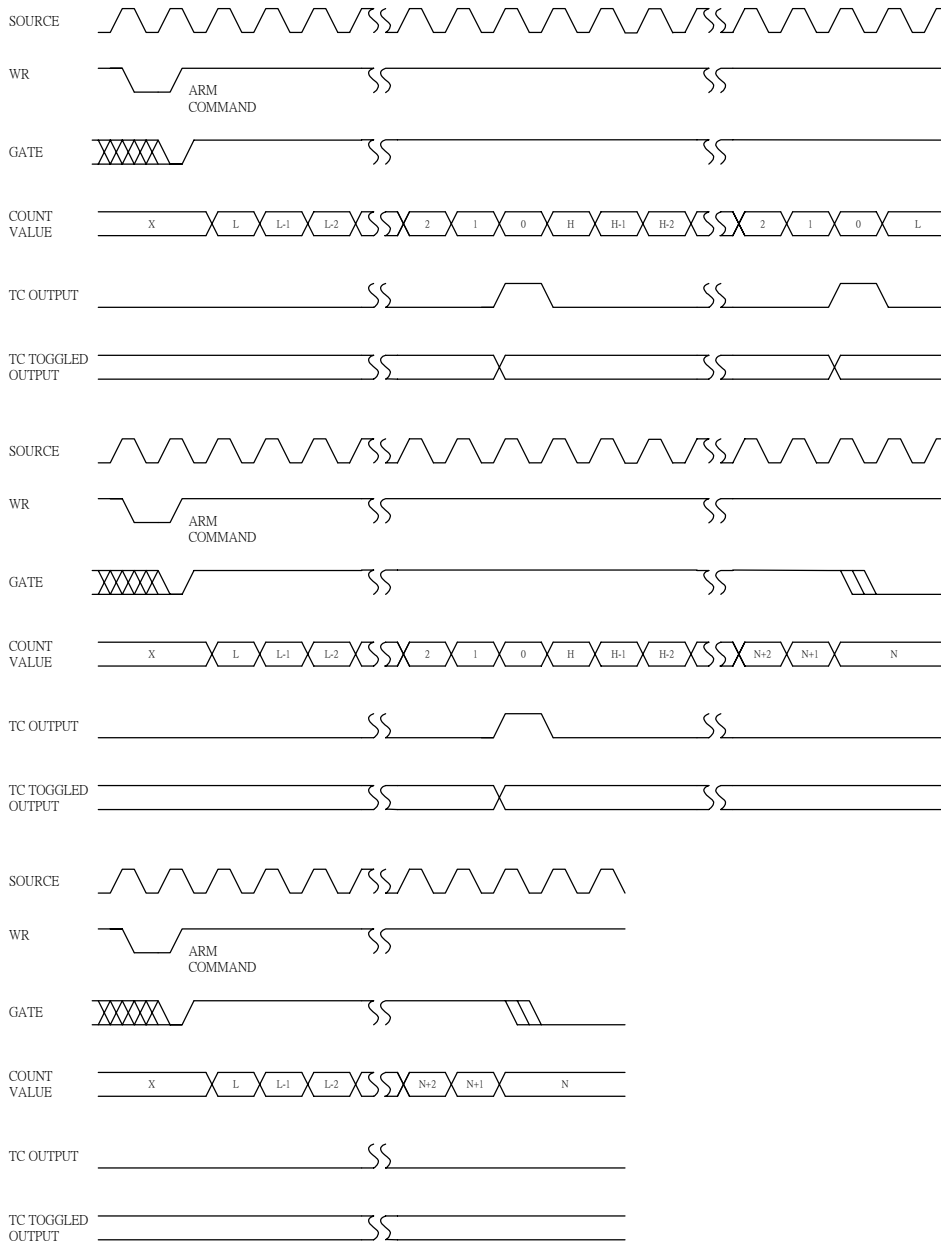

Mode U Waveforms

D.16 Mode X waveform

Hardware-Triggered Delayed Pulse One-Shot with Edge Disarm

Mode X is identical to Mode L except that the counter will be disarmed while an inactive-going Gate edge is applied to the counter. And the counter will hold the count value until it is issued a LOAD command or REST command.

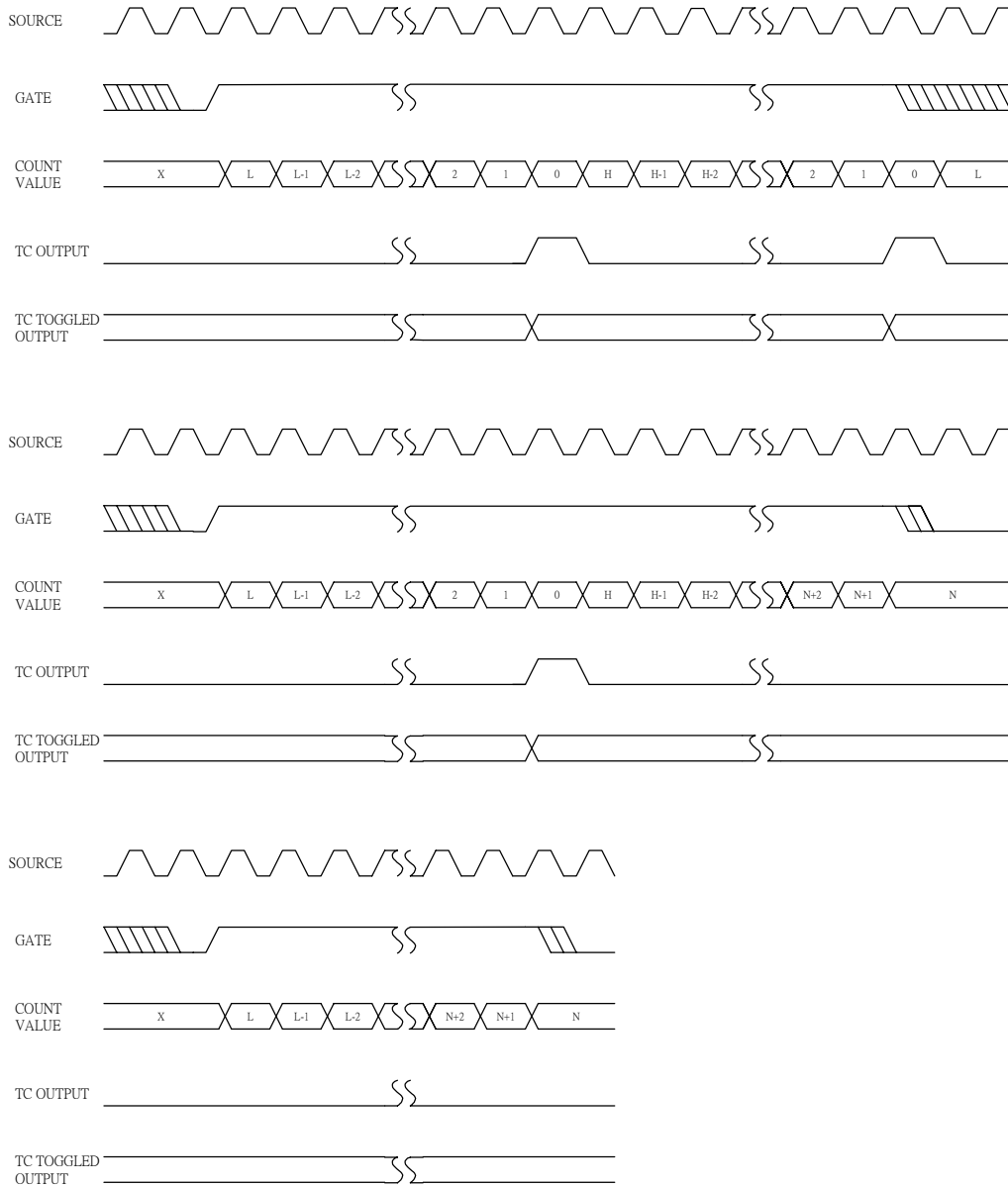

Mode X Waveforms