

User Manual

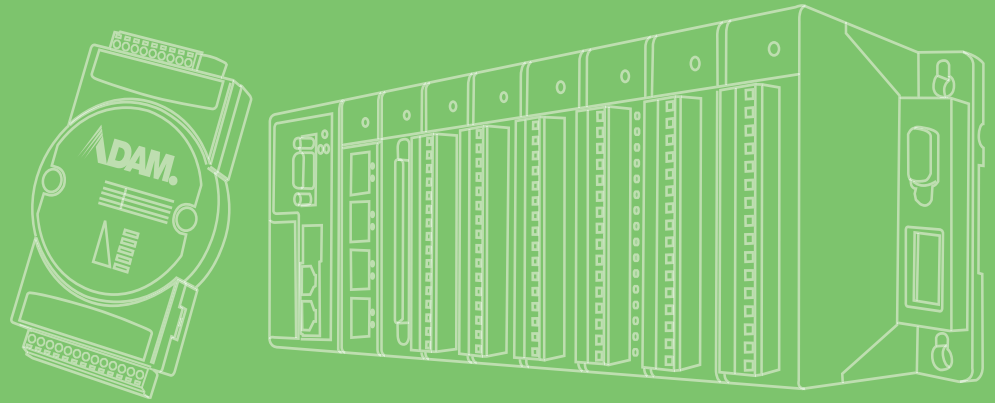

ADAM-5630 Series

ADVANTECH

Enabling an Intelligent Planet

Copyright

The documentation and the software included with this product are copyrighted 2018 by Advantech Co., Ltd. All rights are reserved. Advantech Co., Ltd. reserves the right to make improvements in the products described in this manual at any time without notice. No part of this manual may be reproduced, copied, translated or transmitted in any form or by any means without the prior written permission of Advantech Co., Ltd. Information provided in this manual is intended to be accurate and reliable. However, Advantech Co., Ltd. assumes no responsibility for its use, nor for any infringements of the rights of third parties, which may result from its use.

Acknowledgements

Intel and Pentium are trademarks of Intel Corporation.

Microsoft Windows and MS-DOS are registered trademarks of Microsoft Corp.

All other product names or trademarks are properties of their respective owners.

Product Warranty (2 years)

Advantech warrants to you, the original purchaser, that each of its products will be free from defects in materials and workmanship for two years from the date of purchase.

This warranty does not apply to any products which have been repaired or altered by persons other than repair personnel authorized by Advantech, or which have been subject to misuse, abuse, accident or improper installation. Advantech assumes no liability under the terms of this warranty as a consequence of such events.

Because of Advantech's high quality-control standards and rigorous testing, most of our customers never need to use our repair service. If an Advantech product is defective, it will be repaired or replaced at no charge during the warranty period. For out-of-warranty repairs, you will be billed according to the cost of replacement materials, service time and freight. Please consult your dealer for more details.

If you think you have a defective product, follow these steps:

1. Collect all the information about the problem encountered. (For example, CPU speed, Advantech products used, other hardware and software used, etc.) Note anything abnormal and list any onscreen messages you get when the problem occurs.
2. Call your dealer and describe the problem. Please have your manual, product, and any helpful information readily available.
3. If your product is diagnosed as defective, obtain an RMA (return merchandise authorization) number from your dealer. This allows us to process your return more quickly.
4. Carefully pack the defective product, a fully-completed Repair and Replacement Order Card and a photocopy proof of purchase date (such as your sales receipt) in a shippable container. A product returned without proof of the purchase date is not eligible for warranty service.
5. Write the RMA number visibly on the outside of the package and ship it prepaid to your dealer.

Part No. 2003563000

Printed in Taiwan

Edition 1

September 2018

Declaration of Conformity

CE

This product has passed the CE test for environmental specifications when shielded cables are used for external wiring. We recommend the use of shielded cables. This kind of cable is available from Advantech. Please contact your local supplier for ordering information.

FCC Class A

Note: This equipment has been tested and found to comply with the limits for a Class A digital device, pursuant to part 15 of the FCC Rules. These limits are designed to provide reasonable protection against harmful interference when the equipment is operated in a commercial environment. This equipment generates, uses, and can radiate radio frequency energy and, if not installed and used in accordance with the instruction manual, may cause harmful interference to radio communications. Operation of this equipment in a residential area is likely to cause harmful interference in which case the user will be required to correct the interference at his own expense.

Technical Support and Assistance

1. Visit the Advantech web site at www.advantech.com/support where you can find the latest information about the product.
2. Contact your distributor, sales representative, or Advantech's customer service center for technical support if you need additional assistance. Please have the following information ready before you call:
 - Product name and serial number
 - Description of your peripheral attachments
 - Description of your software (operating system, version, application software, etc.)
 - A complete description of the problem
 - The exact wording of any error messages

Warnings, Cautions and Notes

Warning! Warnings indicate conditions, which if not observed, can cause personal injury!



Caution! Cautions are included to help you avoid damaging hardware or losing data. e.g.



There is a danger of a new battery exploding if it is incorrectly installed. Do not attempt to recharge, force open, or heat the battery. Replace the battery only with the same or equivalent type recommended by the manufacturer. Discard used batteries according to the manufacturer's instructions.

Note! Notes provide optional additional information.



Packing List

The accessory package of ADAM-5630 series contains the following items:

- (A) ADAM-5630 series
- (B) 1 x warranty card

Safety Instructions

1. Read these safety instructions carefully.
2. Keep this User Manual for later reference.
3. Disconnect this equipment from any AC outlet before cleaning. Use a damp cloth. Do not use liquid or spray detergents for cleaning.
4. For plug-in equipment, the power outlet socket must be located near the equipment and must be easily accessible.
5. Keep this equipment away from humidity.
6. Put this equipment on a reliable surface during installation. Dropping it or letting it fall may cause damage.
7. The openings on the enclosure are for air convection. Protect the equipment from overheating. **DO NOT COVER THE OPENINGS.**
8. Make sure the voltage of the power source is correct before connecting the equipment to the power outlet.
9. Position the power cord so that people cannot step on it. Do not place anything over the power cord.
10. All cautions and warnings on the equipment should be noted.
11. If the equipment is not used for a long time, disconnect it from the power source to avoid damage by transient overvoltage.
12. Never pour any liquid into an opening. This may cause fire or electrical shock.
13. Never open the equipment. For safety reasons, the equipment should be opened only by qualified service personnel.
14. If one of the following situations arises, get the equipment checked by service personnel:
 - The power cord or plug is damaged.
 - Liquid has penetrated into the equipment.
 - The equipment has been exposed to moisture.
 - The equipment does not work well, or you cannot get it to work according to the user's manual.
 - The equipment has been dropped and damaged.
 - The equipment has obvious signs of breakage.
15. **DO NOT LEAVE THIS EQUIPMENT IN AN ENVIRONMENT WHERE THE STORAGE TEMPERATURE MAY GO BELOW -25° C (-13° F) OR ABOVE 70° C (158° F). THIS COULD DAMAGE THE EQUIPMENT. THE EQUIPMENT SHOULD BE IN A CONTROLLED ENVIRONMENT.**
16. **CAUTION: DANGER OF EXPLOSION IF BATTERY IS INCORRECTLY REPLACED. REPLACE ONLY WITH THE SAME OR EQUIVALENT TYPE RECOMMENDED BY THE MANUFACTURER, DISCARD USED BATTERIES ACCORDING TO THE MANUFACTURER'S INSTRUCTIONS.**

17. Due to the sensitive nature of the equipment it must be stored in a restricted access location, only accessible by qualified engineers.
18. When installing this equipment, ensure that the Earth cable is securely attached using a 3.5 mm screw.
19. The equipment does not include a power cord and plug. The sound pressure level at the operator's position according to IEC 704-1:1982 is no more than 70 dB (A).

DISCLAIMER: This set of instructions is given according to IEC 704-1. Advantech disclaims all responsibility for the accuracy of any statements contained herein.

Safety Precaution - Static Electricity

Follow these simple precautions to protect yourself from harm and the products from damage.

- To avoid electrical shock, always disconnect the power from your PC chassis before you work on it. Don't touch any components on the CPU card or other cards while the PC is on.
- Disconnect power before making any configuration changes. The sudden rush of power as you connect a jumper or install a card may damage sensitive electronic components.

Contents

Chapter 1	Introduction.....	1
1.1	Product Concepts and Positioning	2
	Table 1.1: Supported I/O Module List.....	2
1.2	Hardware Specifications	3
	1.2.1 General	3
	1.2.2 System Hardware	3
	1.2.3 System Software.....	3
	1.2.4 I/O Interface	3
	1.2.5 Environment.....	3
1.3	Safety Precautions	4
1.4	Chassis Dimensions.....	5
	Figure 1.1 ADAM-5630E chassis dimensions	5
	Figure 1.2 ADAM-5630 chassis dimensions.....	5
Chapter 2	Overview.....	1
2.1	Overview	2
	Figure 2.1 ADAM-5630E overview (the I/O module are optional, not included).....	2
2.2	LED Status Indicator	2
	Figure 2.2 ADAM-5630 series LED status indicator	2
2.2.1	System Status Indicator.....	3
Chapter 3	Wiring and Installation	1
3.1	Wiring	2
3.1.1	Power Supply Wiring.....	2
	Figure 3.1 Power Supply Wiring	2
	Table 3.1: DC Power Input Connector Pin Definition	2
3.1.2	Communication Ports.....	2
	Table 3.2: Debug Port Pin Definitions	2
	Table 3.3: USB Connector Pin Assignment.....	3
	Table 3.4: VGA Adaptor Cable Pin Assignments	4
	Table 3.5: Node ID Setting	4
3.2	Jumper Setting	5
3.2.1	Jumper Setting.....	5
	Figure 3.2 The location of Jumper on the power board	5
	Table 3.6: Jumper Setting for COM1	5
	Table 3.7: Jumper Setting for COM2, 3.....	6
	Figure 3.3 The location of Jumper on the main board	6
	Table 3.8: Jumper Setting for COM4.....	7
3.3	Installation	8
3.3.1	System mounting	8
	Figure 3.4 DIN-rail mounted Installation (8 slots as example)	8
	Figure 3.5 Wall mounted Installation (8 slots as example)	8
3.3.2	SD Card Installation	9
	Figure 3.6 SD Card Installation.....	9
3.3.3	Change RTC Battery.....	9
	Figure 3.7 Battery replacement	9

Chapter 1

Introduction

1.1 Product Concepts and Positioning

ADAM-5630 is a RISC architecture platform with high performance, wide temperature and flexible design. It serves as an edge intelligent DAQ platform connecting the multi field site devices and remote monitoring center by industry protocol, supporting 4/8 I/O slots for sensing and control in energy and environment application, which plays an important role.

To organize an ADAM-5630 Series Controller, you need to select I/O modules to interface the main unit with field devices or processes that you have previously determined. Advantech provides the following types of ADAM-5000 I/O modules for various applications so far. Following table is the I/O modules support list we provided for user's choice.

Table 1.1: Supported I/O Module List

Module	Name	Specification
Analog I/O	ADAM-5013	3-ch RTD input
	ADAM-5017	8-ch AI
	ADAM-5017P	8-ch AI with independent Input
	ADAM-5017H	8-ch High-speed AI
	ADAM-5017UH	8-ch Ultra high speed AI
	ADAM-5018	7-ch Thermocouple input
	ADAM-5018P	7-ch Thermocouple input with independent Input
	ADAM-5024	4-ch AO
Digital I/O	ADAM-5050	16-ch DI/O
	ADAM-5051	16-ch DI
	ADAM-5051D	16-ch DI w/LED
	ADAM-5051S	16-ch Isolated DI w/LED
	ADAM-5052	8-ch DI
	ADAM-5053S	32-ch Isolated DI (TTL)
	ADAM-5055S	16-ch. Isolated DI/O w/LED
	ADAM-5056	16-ch DO
	ADAM-5056D	16-ch DO w/LED
	ADAM-5056S	16-ch Isolated DO w/LED
	ADAM-5056SO	16-ch Iso. DO w/LED (source)
ADAM-5057S	32-ch Isolated DO (TTL)	
Relay Output	ADAM-5060	6-ch. Relay output
	ADAM-5069	8-Ch Power Relay output w/ LED
Counter/Frequency	ADAM-5080	4-ch Counter/Frequency
	ADAM-5081	4-ch High Speed Counter/Frequency
Serial I/O	ADAM-5091	4-port RS232/422/485 with Isolated

1.2 Hardware Specifications

1.2.1 General

- Certification: CE, FCC
- Dimensions (W x D x H):
 - 4 slots: 231 x 75 x 110 mm
 - 8 slots: 355 x 75 x 110 mm
- Enclosure: ABS +PC
- Mounting: DIN-Rain, Wall-Mount
- Power Consumption: 8W (Typical, no added on card)
- Power Requirements: 10~30 V_{DC}
- System Design: Fanless with no internal cabling
- OS Support: Real time Linux

1.2.2 System Hardware

- CPU: TI Cortex A8, 600MHz
- Memory: DDR3L 512GB
- Indicators: LEDs for Power, LAN (LINK, ACT), BAT, ERR, Programmable (LED1~LED4)
- Storage: 1GB Micro-SD card for system storage
- SD Slot: 1 x Micro-SD slot
- Display: DB15 VGA connector, 800x600 @ 60 Hz
- Watchdog Timer: Programmable 7-tier event handler, from 1 to 255 seconds for each tier
- Node ID: 8-bit

1.2.3 System Software

- OS Support: RT-Linux 3.12 above (Distributor: Yocto)
- Configuration Tool: web, C language
- Protocol Support: Modbus/TCP, Modbus/RTU
- Programming: Linux C

1.2.4 I/O Interface

- Serial Ports:
 - COM1: RS-232/485 (Screw terminal) Isolation 2500 V_{DC}
 - COM2: RS-485 (Screw terminal) Isolation 2500 V_{DC}
 - COM3: RS-485 (Screw terminal) Isolation 2500 V_{DC}
 - COM4: RS-232/485 (DB-9)
- Serial Port Speed: RS-232/RS-485: 50 ~ 115.2 kbps
- LAN: 2 x 10/100/1000 Base-T RJ-45 ports
- USB Ports: 2 x USB, Rev. 2.0 compliant

1.2.5 Environment

- Humidity: 5 ~ 95% (non-condensing)
- Operating Temperature: -40~70°C
- Storage Temperature: -40~85°C
- Safety Cert. Temperature: -20~50°C (-4~122° F)

- Operating Humidity: 20 ~ 95% (non-condensing)
- Shock Protection: IEC 60068-2-27
- Vibration Protection: IEC 60068-2-64 (Random 1 Oct./min, 1hr/axis.)

1.3 Safety Precautions

The following messages inform how to make each connection. In most cases, you will simply need to connect a standard cable

Warning! *Always disconnect the power cord from your chassis whenever you are working on it. Do not connect while the power is on. A sudden rush of power can damage sensitive electronic components. Only experienced electronics personnel should open the chassis.*



Caution! *Always ground yourself to remove any static electric charge before touching ADAM-5000 series. Modern electronic devices are very sensitive to static electric charges. Use a grounding wrist strap at all times. Place all electronic components on a static-dissipative surface or in a static-shielded bag.*



Note! *If DC voltage is supplied by an external circuit, please put a protection device in the power supply input port.*



1.4 Chassis Dimensions

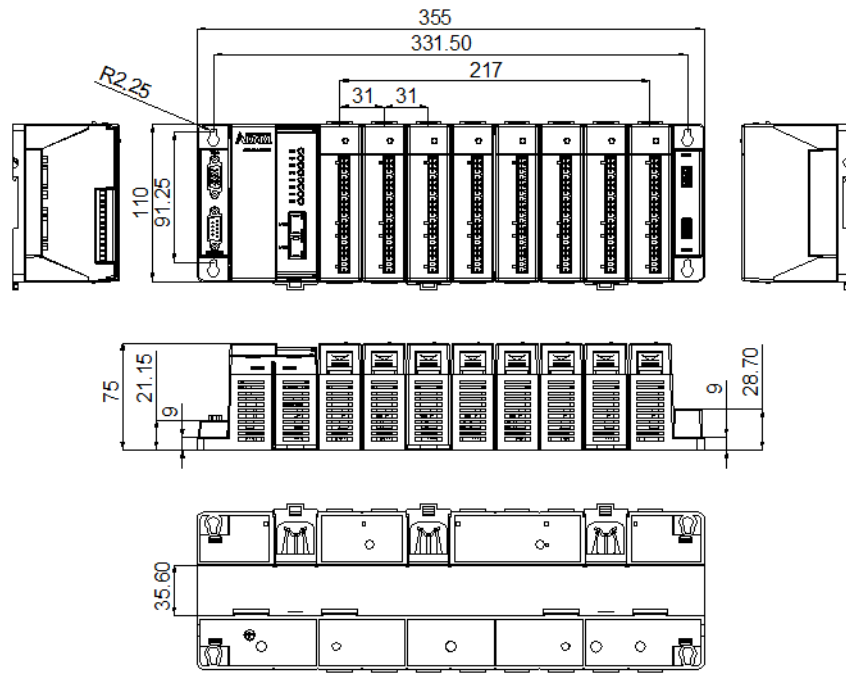

Figure 1.1 ADAM-5630E chassis dimensions

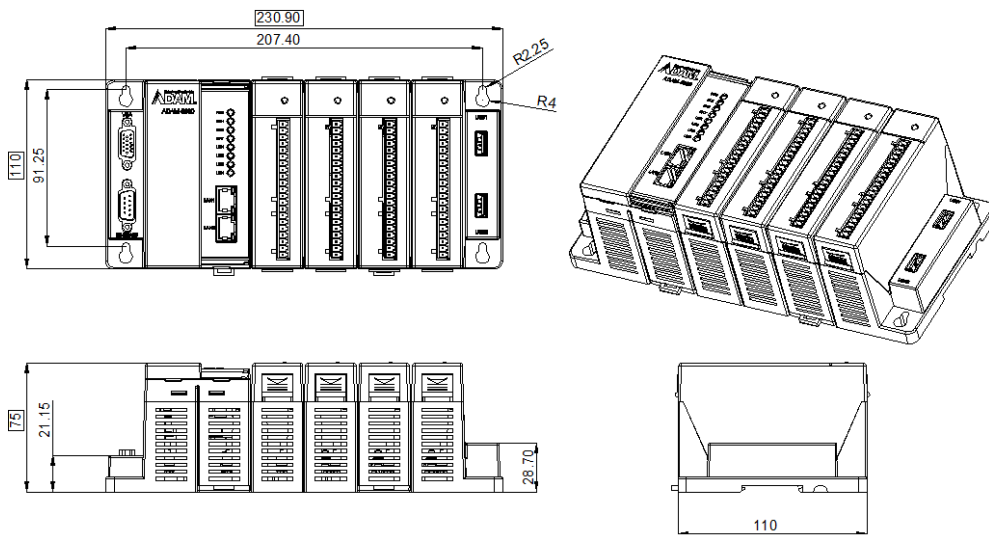

Figure 1.2 ADAM-5630 chassis dimensions

Chapter 2

Overview

2.1 Overview

The following figures show the indicators and connectors on ADAM-5630E.

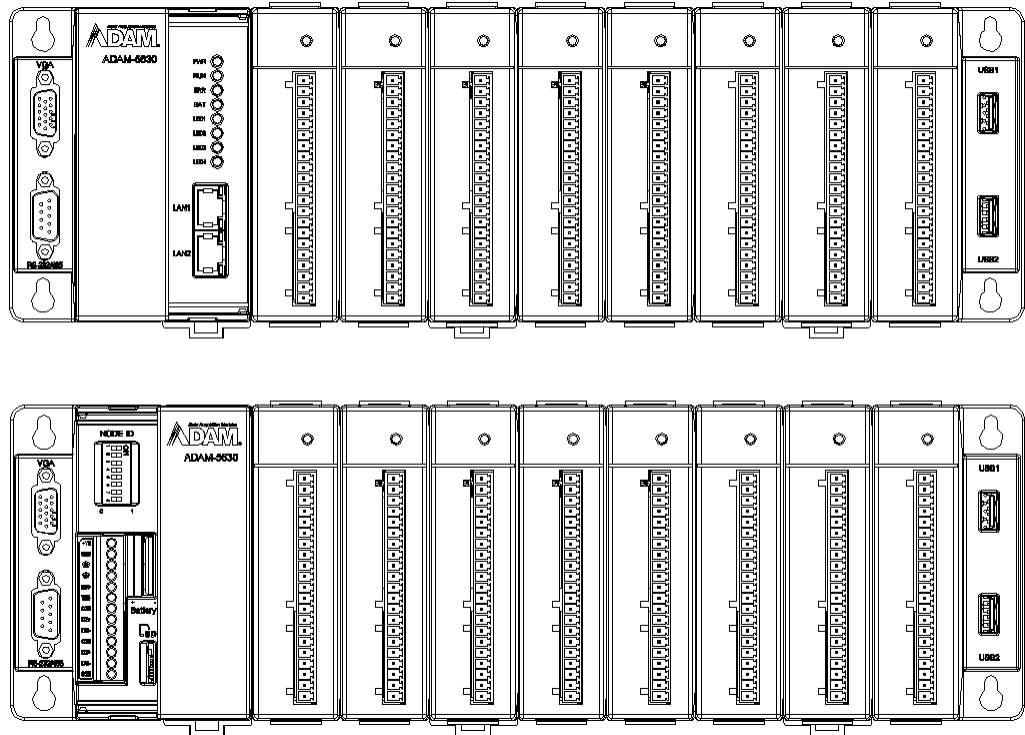

Figure 2.1 ADAM-5630E overview (the I/O module are optional, not included)

2.2 LED Status Indicator

- PWR ○
- RUN ○
- ERR ○
- BAT ○
- LED1 ○
- LED2 ○
- LED3 ○
- LED4 ○

Figure 2.2 ADAM-5630 series LED status indicator

2.2.1 System Status Indicator

LED	Status	Description
PWR	Green	Power is on
	Off	Power is off
BAT	On	Need to change Battery
	Off	Normal
LED1~LED4	Green	Customers can define the Programmable LED state according to the actual need.
	Off	

Chapter 3

Wiring and Installation

3.1 Wiring

3.1.1 Power Supply Wiring

ADAM-5630 supports power input ranging from 10 V_{DC} to 30V_{DC}.

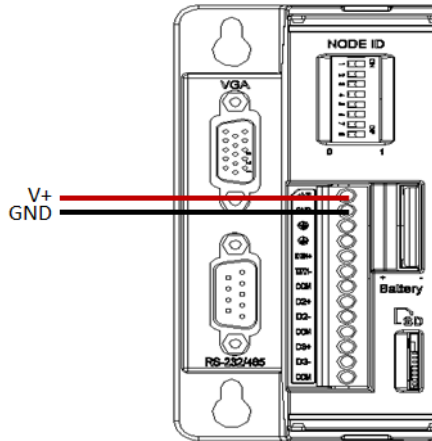

Figure 3.1 Power Supply Wiring

Table 3.1: DC Power Input Connector Pin Definition

Function	Pin	Screen Printing	Function Description
Power Input	1	V+	DC power input PIN
	2	GND	DC power input PIN
	3	⊕	GND

3.1.2 Communication Ports

3.1.2.1 DB-9 COM Ports (COM4)

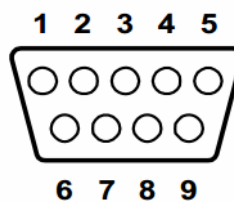
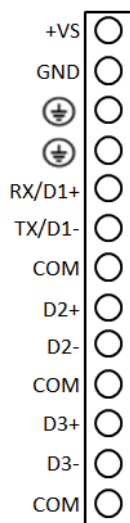

Table 3.2: Debug Port Pin Definitions

Pins	RS-232	RS-485
1	DCD	DATA-
2	RXD	
3	TXD	
4	DTR	DATA+
5	GND	
6	DSR	
7	RTS	
8	CTS	
9	RI	

3.1.2.2 Terminal Connector



3.1.2.3 USB Connector



Table 3.3: USB Connector Pin Assignment

Pin	Signal	Cable Color
1	VCC	Red
2	DATA-	White
3	DATA+	Green
4	GND	Black

3.1.2.4 LAN Connectors (LAN1~LAN2)



LED	Color	Description
Link	Orange	Lighting, Ethernet not connected
Act	Green	Blinking, Ethernet data being transmitted

3.1.2.5 VGA Display Connector

Table 3.4: VGA Adaptor Cable Pin Assignments

Pin	Assignment
1	RED
2	GREEN
3	BLUE
4	N/C
5	GND
6	GND
7	GND
8	GND
9	VCC
10	GND
11	N/C
12	N/C
13	N/C
14	N/C
15	N/C

3.1.2.6 Dial Switch Setting

ADAM-5630 series have an 8-bit node ID. The detailed definition is as follows:

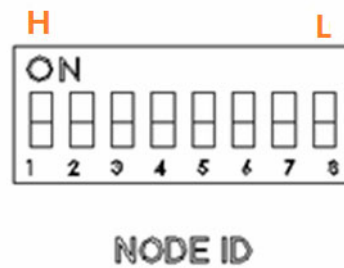

Table 3.5: Node ID Setting

Node ID	8-bit, support 0~255 devices.
---------	-------------------------------

3.2 Jumper Setting

3.2.1 Jumper Setting

The ADAM-5630 series has two types of jumper for user operation, as the below shown.

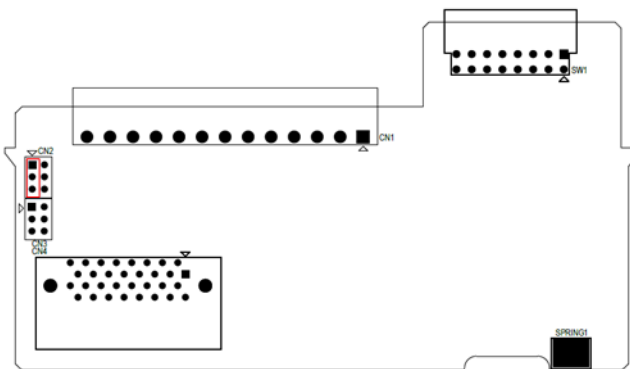
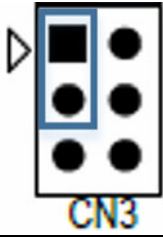
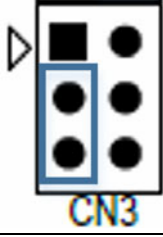
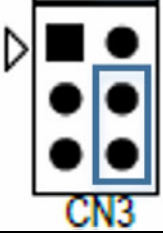
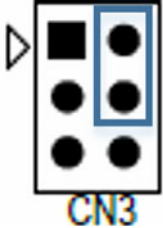

Figure 3.2 The location of Jumper on the power board

Table 3.6: Jumper Setting for COM1

Location	Description
	RS-232 mode for COM1
	RS-485 mode for COM1
	COM1 120 ohm TR in RS-485 mode
	COM1 300 ohm TR in RS-485 mode

Table 3.7: Jumper Setting for COM2, 3

Location	Description
	COM2 120 ohm TR in RS-485 mode
	COM2 300 ohm TR in RS-485 mode
CN3	
	COM3 120 ohm TR in RS-485 mode
	COM3 300 ohm TR in RS-485 mode

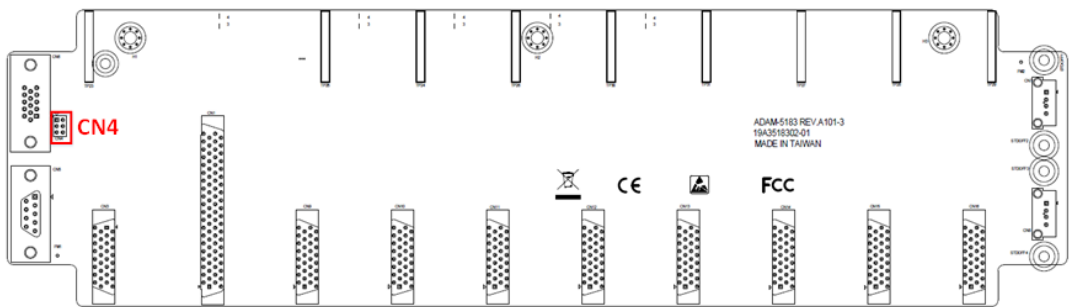
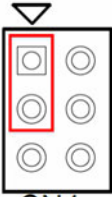
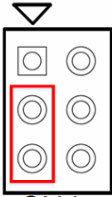
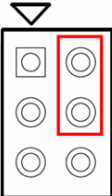
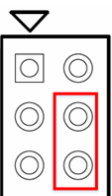

Figure 3.3 The location of Jumper on the main board

Table 3.8: Jumper Setting for COM4

Location	Description
 <p data-bbox="485 510 552 539">CN4</p>	RS-232 mode for COM4
 <p data-bbox="485 750 552 779">CN4</p>	RS-485 mode for COM4
 <p data-bbox="485 990 552 1019">CN4</p>	COM4 120 ohm TR in RS-485 mode
 <p data-bbox="485 1229 552 1258">CN4</p>	COM4 300 ohm TR in RS-485 mode

3.3 Installation

3.3.1 System mounting

ADAM-5630 series provides DIN-rail and wall mount, please refer the following examples:

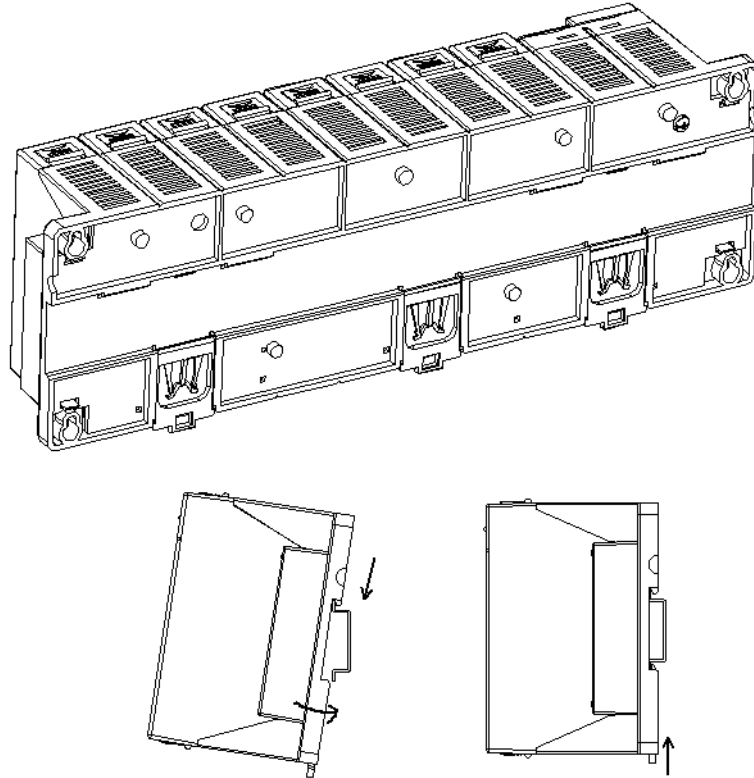

Figure 3.4 DIN-rail mounted Installation (8 slots as example)

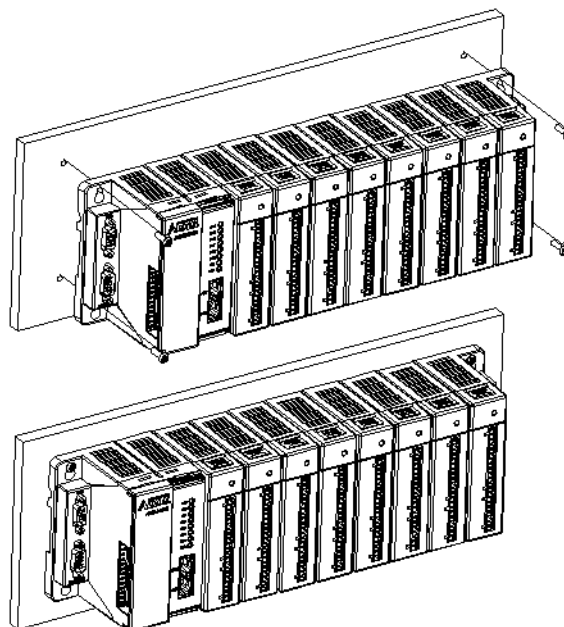

Figure 3.5 Wall mounted Installation (8 slots as example)

3.3.2 SD Card Installation

ADAM-5630 series are equipped with one Micro SD slots for data storage.

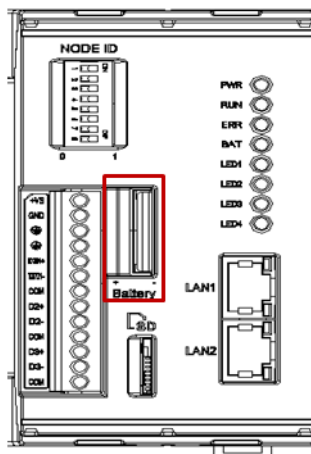

Figure 3.6 SD Card Installation

3.3.3 Change RTC Battery

ADAM-5630 series provide the external battery slot for user can easy change it.

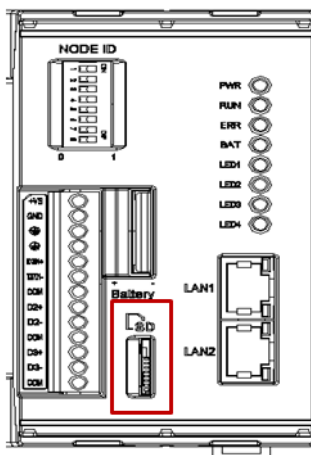

Figure 3.7 Battery replacement

www.advantech.com

Please verify specifications before quoting. This guide is intended for reference purposes only.

All product specifications are subject to change without notice.

No part of this publication may be reproduced in any form or by any means, electronic, photocopying, recording or otherwise, without prior written permission of the publisher.

All brand and product names are trademarks or registered trademarks of their respective companies.

© Advantech Co., Ltd. 2018