



NEXCOM International Co., Ltd.

Mobile Computing Solutions

Vehicle Telematics Computer

VTC 7250-7C8

User Manual

NEXCOM International Co., Ltd.

Published April 2022

www.nexcom.com

CONTENTS

Preface

Copyright	iv
Disclaimer	iv
Acknowledgements	iv
Regulatory Compliance Statements	iv
Declaration of Conformity.....	iv
RoHS Compliance	v
Warranty and RMA	vi
Technical Support and Assistance.....	ix
Conventions Used in this Manual.....	ix
Global Service Contact Information.....	x
Package Contents.....	xii

Chapter 1: Product Introduction

Physical Features.....	1
Front View.....	1
Rear View.....	1
Hardware Specifications.....	2
Connector Numbering	4

Chapter 2: External Connectors Pinout Description

ultraONE+ Connector.....	5
VGA Connector.....	5
Dual USB 3.1 Port.....	6
HDMI Connector	6
SIM2 and SIM3 Sockets.....	7

Reset Button.....	7
Power Button	8
Mic-in Connector	8
Line-out Connector	9
Dual USB 3.1 Port.....	9
Dual USB 3.1 Port.....	10
CAN/DIO Multiport Connector.....	10
COM1 RS232 Connector.....	11
COM3 RS-232/RS422/RS485 Connector	11
COM2 RS232 Connector.....	12
DC Out Connector	12
9V-36V DC Power Input	13
PoE1 to PoE4 Ports	13
PoE5 to PoE8 Ports	14

Chapter 3: Jumpers and Switches

Before You Begin	15
Precautions	15
Jumper Settings	16
Locations of the Jumpers and Connectors for the Motherboard.....	17
Top View.....	17
Bottom View.....	18
DIP Switch Settings.....	19
RTC Clear Selection.....	19
CAN Bus Impedance Control.....	19
Input Voltage Setup Selection.....	20

LVDS Resolution Control.....	20
GPIO Pull High Selection Switch	21
Internal Connectors.....	22
COM1 RS232 DB9 Connector	22
SIM Card Slot	22
GPS Wire to Board Connector	23
GPS Wire to Board Connector	23
GPS Battery Connector.....	24
RTC Battery Connector.....	24
RTC Battery Connector.....	25
Debug 80 Port Connector	25
USB Connectors (Reserved)	26
CAN-MCU Update Port	26
CAN-MCU Debug Port	27
MCU Debug Port	27
MCU Download Port.....	28
Mini-PCIe for USB/PCIe/mSATA.....	29
Mini-PCIe for USB/PCIe.....	30
Mini-PCIe for USB	31
M.2 B-Key for USB 3.0 + USB 2.0 (Reserved)	32
M.2 B-Key for USB 3.0 + USB 2.0.....	33
PoE Power & Low Speed Signal Connector	34
PoE High Speed Signal Connector	35
Locations of the Jumpers and Connectors for the PoE Expansion Module (VIOB-POE8-03)	36
Top View.....	36
Internal Connectors.....	37
SATA Connectors (7-pin and 15-pin)	37
Low Speed Board to Board Connector.....	38
High Speed Board to Board Connector.....	39
Chapter 4: System Setup	
Removing the Chassis Cover	40

Removing the CPU.....	42
Removing the Memory Module.....	43
Installing a WWAN Module (Mini-PCIe)	43
Installing a WWAN Module (M.2).....	44
Installing a WLAN Module (Half Mini-PCIe).....	44
Installing a SIM Card	45
Installing a SSD/HDD Drive	46

Appendix A: Software Demo Utility for I/O Ports of Function Control

Menu Screen	48
1. Config1	48
2. Config2.....	50
3. Config3	52
4. G-Sensor	53
5. PoE.....	54
6. System Event.....	55

Appendix B: GPS Feature

uBlox-NEO M8 Overview.....	56
Technical Specifications.....	56

Appendix C: Signal Connection of MCU DI/DO

GPIO Pinout Description.....	58
Digital Input.....	59
Digital Output.....	60

Appendix D: Vehicle Power Management Setup

Startup and Shutdown Voltage Setting	61
Power-on Delay Setting.....	63
Power-off Delay Setting	65

Appendix E: Power Consumption.....67

PREFACE

Copyright

This publication, including all photographs, illustrations and software, is protected under international copyright laws, with all rights reserved. No part of this manual may be reproduced, copied, translated or transmitted in any form or by any means without the prior written consent from NEXCOM International Co., Ltd.

Disclaimer

The information in this document is subject to change without prior notice and does not represent commitment from NEXCOM International Co., Ltd. However, users may update their knowledge of any product in use by constantly checking its manual posted on our website: <http://www.nexcom.com>. NEXCOM shall not be liable for direct, indirect, special, incidental, or consequential damages arising out of the use of any product, nor for any infringements upon the rights of third parties, which may result from such use. Any implied warranties of merchantability or fitness for any particular purpose is also disclaimed.

Acknowledgements

VTC 7250 is a trademark of NEXCOM International Co., Ltd. All other product names mentioned herein are registered trademarks of their respective owners.

Regulatory Compliance Statements

This section provides the FCC compliance statement for Class A devices and describes how to keep the system CE compliant.

Declaration of Conformity

FCC

This equipment has been tested and verified to comply with the limits for a Class A digital device, pursuant to Part 15 of FCC Rules. These limits are designed to provide reasonable protection against harmful interference when the equipment is operated in a commercial environment. This equipment generates, uses, and can radiate radio frequency energy and, if not installed and used in accordance with the instructions, may cause harmful interference to radio communications. Operation of this equipment in a residential area (domestic environment) is likely to cause harmful interference, in which case the user will be required to correct the interference (take adequate measures) at their own expense.

CE

The product(s) described in this manual complies with all applicable European Union (CE) directives if it has a CE marking. For computer systems to remain CE compliant, only CE-compliant parts may be used. Maintaining CE compliance also requires proper cable and cabling techniques.

RoHS Compliance



NEXCOM RoHS Environmental Policy and Status Update

NEXCOM is a global citizen for building the digital infrastructure. We are committed to providing green products and services, which are compliant with European Union RoHS (Restriction on Use of Hazardous Substance in Electronic Equipment) directive 2011/65/EU, to be your trusted green partner and to protect our environment.

RoHS restricts the use of Lead (Pb) < 0.1% or 1,000ppm, Mercury (Hg) < 0.1% or 1,000ppm, Cadmium (Cd) < 0.01% or 100ppm, Hexavalent Chromium (Cr6+) < 0.1% or 1,000ppm, Polybrominated biphenyls (PBB) < 0.1% or 1,000ppm, and Polybrominated diphenyl Ethers (PBDE) < 0.1% or 1,000ppm.

In order to meet the RoHS compliant directives, NEXCOM has established an engineering and manufacturing task force in to implement the introduction of green products. The task force will ensure that we follow the standard NEXCOM development procedure and that all the new RoHS components and new manufacturing processes maintain the highest industry quality levels for which NEXCOM are renowned.

How to recognize NEXCOM RoHS Products?

For existing products where there are non-RoHS and RoHS versions, the suffix "(LF)" will be added to the compliant product name.

All new product models launched after January 2013 will be RoHS compliant. They will use the usual NEXCOM naming convention.

Warranty and RMA

NEXCOM Warranty Period

NEXCOM manufactures products that are new or equivalent to new in accordance with industry standard. NEXCOM warrants that products will be free from defect in material and workmanship for 2 years, beginning on the date of invoice by NEXCOM.

NEXCOM Return Merchandise Authorization (RMA)

- Customers shall enclose the “NEXCOM RMA Service Form” with the returned packages.
- Customers must collect all the information about the problems encountered and note anything abnormal or, print out any on-screen messages, and describe the problems on the “NEXCOM RMA Service Form” for the RMA number apply process.
- Customers can send back the faulty products with or without accessories (manuals, cable, etc.) and any components from the card, such as CPU and RAM. If the components were suspected as part of the problems, please note clearly which components are included. Otherwise, NEXCOM is not responsible for the devices/parts.
- Customers are responsible for the safe packaging of defective products, making sure it is durable enough to be resistant against further damage and deterioration during transportation. In case of damages occurred during transportation, the repair is treated as “Out of Warranty.”
- Any products returned by NEXCOM to other locations besides the customers’ site will bear an extra charge and will be billed to the customer.

Repair Service Charges for Out-of-Warranty Products

NEXCOM will charge for out-of-warranty products in two categories, one is basic diagnostic fee and another is component (product) fee.

System Level

- Component fee: NEXCOM will only charge for main components such as SMD chip, BGA chip, etc. Passive components will be repaired for free, ex: resistor, capacitor.
- Items will be replaced with NEXCOM products if the original one cannot be repaired. Ex: motherboard, power supply, etc.
- Replace with 3rd party products if needed.
- If RMA goods can not be repaired, NEXCOM will return it to the customer without any charge.

Board Level

- Component fee: NEXCOM will only charge for main components, such as SMD chip, BGA chip, etc. Passive components will be repaired for free, ex: resistors, capacitors.
- If RMA goods can not be repaired, NEXCOM will return it to the customer without any charge.

Warnings

Read and adhere to all warnings, cautions, and notices in this guide and the documentation supplied with the chassis, power supply, and accessory modules. If the instructions for the chassis and power supply are inconsistent with these instructions or the instructions for accessory modules, contact the supplier to find out how you can ensure that your computer meets safety and regulatory requirements.

Cautions

Electrostatic discharge (ESD) can damage system components. Do the described procedures only at an ESD workstation. If no such station is available, you can provide some ESD protection by wearing an antistatic wrist strap and attaching it to a metal part of the computer chassis.

Safety Information

Before installing and using the device, note the following precautions:

- Read all instructions carefully.
- Do not place the unit on an unstable surface, cart, or stand.
- Follow all warnings and cautions in this manual.
- When replacing parts, ensure that your service technician uses parts specified by the manufacturer.
- Avoid using the system near water, in direct sunlight, or near a heating device.
- The load of the system unit does not solely rely for support from the rackmounts located on the sides. Firm support from the bottom is highly necessary in order to provide balance stability.
- The computer is provided with a battery-powered real-time clock circuit. There is a danger of explosion if battery is incorrectly replaced. Replace only with the same or equivalent type recommended by the manufacturer. Discard used batteries according to the manufacturer's instructions.

Installation Recommendations

Ensure you have a stable, clean working environment. Dust and dirt can get into components and cause a malfunction. Use containers to keep small components separated.

Adequate lighting and proper tools can prevent you from accidentally damaging the internal components. Most of the procedures that follow require only a few simple tools, including the following:

- A Philips screwdriver
- A flat-tipped screwdriver
- A grounding strap
- An anti-static pad

Using your fingers can disconnect most of the connections. It is recommended that you do not use needlenose pliers to disconnect connections as these can damage the soft metal or plastic parts of the connectors.

Warning!

1. Handling the unit: carry the unit with both hands and handle it with care.
2. Maintenance: to keep the unit clean, use only approved cleaning products or clean with a dry cloth.
3. CompactFlash: Turn off the unit's power before inserting or removing a CompactFlash storage card.
4. SIM: Do not insert or remove the SIM card when the **system is powered** on. Always **power** off the **system** before inserting or removing the SIM card.

Safety Precautions

- Read these safety instructions carefully.
- Keep this User Manual for later reference.
- Disconnect this equipment from any AC outlet before cleaning. Use a damp cloth. Do not use liquid or spray detergents for cleaning.
- For plug-in equipment, the power outlet socket must be located near the equipment and must be easily accessible.
- Keep this equipment away from humidity.
- Put this equipment on a stable surface during installation. Dropping it or letting it fall may cause damage.
- Do not leave this equipment in either an unconditioned environment or in a above 40°C storage temperature as this may damage the equipment.
- The openings on the enclosure are for air convection to protect the equipment from overheating. DO NOT COVER THE OPENINGS.
- Make sure the voltage of the power source is correct before connecting the equipment to the power outlet.
- Place the power cord in a way so that people will not step on it. Do not place anything on top of the power cord. Use a power cord that has been approved for use with the product and that it matches the voltage and current marked on the product's electrical range label. The voltage and current rating of the cord must be greater than the voltage and current rating marked on the product.
- All cautions and warnings on the equipment should be noted.
- If the equipment is not used for a long time, disconnect it from the power source to avoid damage by transient overvoltage.
- Never pour any liquid into an opening. This may cause fire or electrical shock.
- Never open the equipment. For safety reasons, the equipment should be opened only by qualified service personnel.
- If one of the following situations arises, get the equipment checked by service personnel:
 - a. The power cord or plug is damaged.
 - b. Liquid has penetrated into the equipment.
 - c. The equipment has been exposed to moisture.
 - d. The equipment does not work well, or you cannot get it to work according to the user's manual.
 - e. The equipment has been dropped and damaged.
 - f. The equipment has obvious signs of breakage.
- Do not place heavy objects on the equipment.
- The unit uses a three-wire ground cable which is equipped with a third pin to ground the unit and prevent electric shock. Do not defeat the purpose of this pin. If your outlet does not support this kind of plug, contact your electrician to replace your obsolete outlet.
- CAUTION: DANGER OF EXPLOSION IF BATTERY IS INCORRECTLY REPLACED. REPLACE ONLY WITH THE SAME OR EQUIVALENT TYPE RECOMMENDED BY THE MANUFACTURER. DISCARD USED BATTERIES ACCORDING TO THE MANUFACTURER'S INSTRUCTIONS.

Technical Support and Assistance

1. For the most updated information of NEXCOM products, visit NEXCOM's website at www.nexcom.com.
2. For technical issues that require contacting our technical support team or sales representative, please have the following information ready before calling:
 - Product name and serial number
 - Detailed information of the peripheral devices
 - Detailed information of the installed software (operating system, version, application software, etc.)
 - A complete description of the problem
 - The exact wordings of the error messages

Warning!

1. Handling the unit: carry the unit with both hands and handle it with care.
2. Maintenance: to keep the unit clean, use only approved cleaning products or clean with a dry cloth.

Conventions Used in this Manual



Warning:

Information about certain situations, which if not observed, can cause personal injury. This will prevent injury to yourself when performing a task.



Caution:

Information to avoid damaging components or losing data.



Note:

Provides additional information to complete a task easily.

Global Service Contact Information

Headquarters

NEXCOM International Co., Ltd.

9F, No. 920, Zhongzheng Rd.,
Zhonghe District, New Taipei City, 23586,
Taiwan, R.O.C.
Tel: +886-2-8226-7786
Fax: +886-2-8226-7782
www.nexcom.com

Asia

Taiwan

NexAIoT Headquarters

Industry 4.0 and Cloud Services

13F, No.922, Zhongzheng Rd.,
Zhonghe District, New Taipei City,
23586, Taiwan, R.O.C.
Tel: +886-2-8226-7796
Fax: +886-2-8226-7926
Email: jacobhuang@nexaiot.com
www.nexaiot.com

NexAIoT Co., Ltd.

Taichung Office

16F, No.250, Sec.2, Chongde Rd.,
Beitun District,
Taichung City, 406, Taiwan, R.O.C.
Tel: +886-4-2249-1179
Fax: +886-4-2249-1172
Email: jacobhuang@nexaiot.com
www.nexaiot.com

NexCOBOT Taiwan Co., Ltd.

13F, No.916, Zhongzheng Rd.,
Zhonghe District,
New Taipei City, 23586, Taiwan, R.O.C.
Tel: +886-2-8226-7786
Fax: +886-2-8226-7926
Email: jennyshern@nexcobot.com
www.nexcobot.com

GreenBase Technology Corp.

13F, No.922, Zhongzheng Rd.,
Zhonghe District,
New Taipei City, 23586, Taiwan, R.O.C.
Tel: +886-2-8226-7786
Fax: +886-2-8226-7900
Email: vivianlin@nexcom.com.tw
www.nexcom.com.tw

DivioTec Inc.

19F-1A, No.97, Sec.4, ChongXin Rd.,
Sanhong District,
New Taipei City, 24161, Taiwan, R.O.C.
Tel: +886-2-8976-3077
Email: sales@diviotec.com
www.diviotec.com

AIoT Cloud Corp.

13F, No.922, Zhongzheng Rd.,
Zhonghe District,
New Taipei City, 23586, Taiwan, R.O.C.
Tel: +886-2-8226-7786
Fax: +886-2-8226-7782
Email: alantsai@aiotcloud.net
www.aiotcloud.dev

EMBUX TECHNOLOGY CO., LTD.

13F, No.916, Zhongzheng Rd.,
Zhonghe District,
New Taipei City, 23586, Taiwan, R.O.C.
Tel: +886-2-8226-7786
Fax: +886-2-8226-7782
Email: info@embux.com
www.embux.com

TMR TECHNOLOGIES CO., LTD.

13F, No.916, Zhongzheng Rd.,
Zhonghe District,
New Taipei City, 23586, Taiwan, R.O.C.
Tel: +886-2-8226-7786
Fax: +886-2-8226-7782
Email: services@tmrtek.com
www.tmrtek.com

China NEXSEC Incorporated

201, Floor 2, Unit 2, Building 15, Yard 3,
Gaolizhang Road, Haidian District,
Beijing, 100094, China
Tel: +86-10-5704-2680
Fax: +86-10-5704-2681
Email: marketing@nexsec.cn
www.nexsec.cn

NEXCOM Shanghai

Room 406-407, Building C, No 154, Lane 953,
Jianchuan Road, Minhang District,
Shanghai, 201108, China
Tel: +86-21-5278-5868
Fax: +86-21-3251-6358
Email: sales@nexcom.cn
www.nexcom.cn

NEXCOM Surveillance Technology Corp.

Floor 8, Building B3, Xiufeng Industrial Zone,
GanKeng Community, Buji Street,
LongGang District,
ShenZhen, 518112, China
Tel: +86-755-8364-7768
Fax: +86-755-8364-7738
Email: steveyang@nexcom.com.tw
www.nexcom.cn

NEXGOL Chongqing

1st Building No.999,
Star Boulevard, Yongchuan Dist,
Chongqing City, 402160, China
Tel: +86-23-4960-9080
Fax: +86-23-4966-5855
Email: sales@nexgol.com.cn
www.nexcobot.cn

Beijing NexGemo Technology Co.,Ltd.

2F, Gemotech Building, No.1, Development Rd.,
Changping International Information Industry Base,
Changping District,
Beijing, 102206, China
Tel: +86-10-8072-2025
Fax: +86-10-8072-2022
Email: sales@gemotech.cn
www.nexgemo.cn

Japan

NEXCOM Japan

9F, Tamachi Hara Bldg.,
4-11-5, Shiba Minato-ku,
Tokyo, 108-0014, Japan
Tel: +81-3-5419-7830
Fax: +81-3-5419-7832
Email: sales@nexcom-jp.com
www.nexcom-jp.com

America

USA NEXCOM USA

46665 Fremont Blvd.,
Fremont CA 94538, USA
Tel: +1-510-656-2248
Fax: +1-510-656-2158
Email: sales@nexcom.com
www.nexcomusa.com

Europe

United Kingdom NEXCOM EUROPE

10 Vincent Avenue,
Crownhill Business Centre,
Milton Keynes, Buckinghamshire
MK8 0AB, United Kingdom
Tel: +44-1908-267121
Fax: +44-1908-262042
Email: sales.uk@nexcom.eu
www.nexcom.com

Package Contents

Before continuing, verify that the VTC 7250 package that you received is complete. Your VTC 7250 package should have all the items listed in the following table.

Item	P/N	Name	Specification	Qty
1	603ANT0115X00	GPS/GLONASS Antenna SANAV:SM-76G	SMA Male L=5000mm	1
2		VTC 7250 DVD Driver VER:1.0		1
3	4NCPF00510X00	Terminal Blocks 5P Phoenix Contact:1778014	5.08mm Female DIP Green	1
4	50333P0028X00	Washer for SMA CONN KANG YANG:WS6-0.8(B)	12.8x6.4x0.8mm PC Black	8
5	50333P0027X00	Washer for SMA CONN KANG YANG:TW-181	13x1.8mm Nylon 66 Natural	8
6	603POW0234X00	Power Cable 8-pin to 6-pin 12V DC OUT SUNJET:SLNEX822910	ATX 2x4 PIT:3.0mm to ATX 2x3 PIT:4.2mm UL1007 22AWG L=200mm	1
7	50311F0581X00	I Head Bolts Screw LONG FEI:I3x15.8 ISO NIGP	I3x5.8 AXISx2.8mm SCREWx3mm	8
8	5061000004X00	Damper Anti-Vibrate Grommet KANG YANG:TGM-50G(B)	D7xH2.8mm TPE COLOR: Black	8

CHAPTER 1: PRODUCT INTRODUCTION

Physical Features

Front View

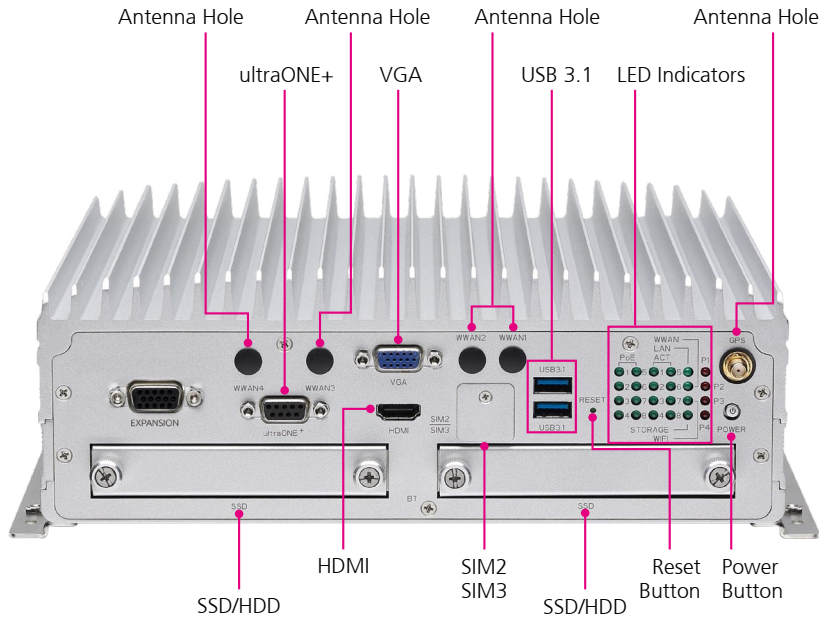

Rear View

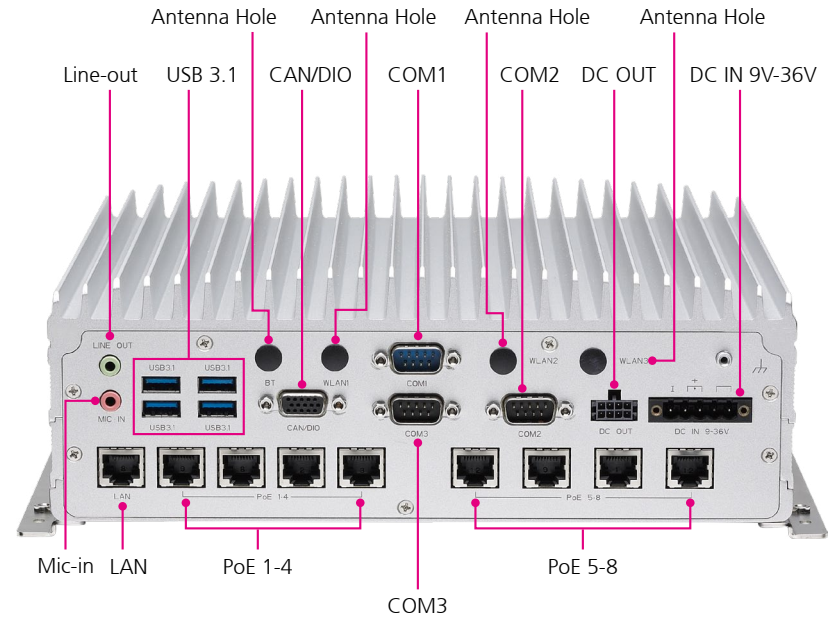

Hardware Specifications

CPU

- 8th generation Intel® Core™ (Coffee Lake-S) i7-8700T, up to 4 GHz, 35W, 6 core
- Compatible Intel® processor (by request)

Chipset

- Intel® Q370 platform controller hub

Memory

- 2-Channel 260-pin DDR4 SO-DIMM sockets up to 32GB/channel (64GB for two channels, non-ECC up to 2666 MHz), default 4GB + 4GB industrial grade memory

Video Output

- Chipset Intel® UHD Graphics 630
- 1 x HDMI 1.4b up to 4096 x 2160@30Hz
- 1 x VGA up to 1920 x 1200@60Hz
- 1 x ultraONE+ compatible with specific monitor

Storage

- 2 x 2.5" SATA 3.0 external SSD (compatible with 15mm height), RAID 0/1 supported
- 2 x mSATA 3.0 (shared with mini-PCIe slot)

Expansion

- 1 x M.2 3042 (default) Key B socket (USB 2.0, USB 3.1) for LTE/5G NR module with dual SIM
- 1 x Full-size mini-PCIe socket (USB 2.0) for LTE with dual SIM. Optional M.2 3042 Key B (USB 2.0, USB 3.1) for LTE/5G NR module

- 1 x Full-size mini-PCIe socket (USB 2.0, PCIe 3.0 & SATA 3.0 [auto detection])
- 1 x Full-size mini-PCIe socket (USB 2.0, PCIe 3.0 & SATA 3.0 [BIOS selection])

GNSS and Onboard Sensor

- 1 x Default U-blox NEO-M8N GNSS module for GPS/Glonass/QZSS/Galileo/Beidou
- Optional M8U/M8L modules with dead reckoning available
- TPM 2.0 by Infineon SLB9665TT2 (optional)
- G Sensor (3-axis, 10-bit resolution)

LAN and Power over Ethernet

- 8-Port LAN, 10/100/1000 Mbps I210-IT GbE, PoE 802.3af/at, max. 60W
- 1-Port LAN, 10/100/1000 Mbps I210-IT GbE

I/O Interface-Front

- 24 x LED indicators (including 4 x programmable LEDs)
- 1 x HDMI 1.4b
- 1 x VGA
- 1 x ultraONE+ for 10M video + audio output + 24VDC output
- 2 x USB 3.1 type A (5V/1A)
- 2 x Externally accessible SIM card sockets
- 2 x 2.5" removable SSD trays
- 1 x Reset button
- 1 x Power button
- 5 x SMA antennas

I/O Interface-Rear

- 8 x PoE 802.3af/at (Max. 60W)
- 1 x RJ45 LAN port, 10/100/1000 Mbps

- 1 x 5-pin terminal block for 9V~36V DC
- 1 x Mic-in, 1 x Line-out
- 1 x Connector (4 x 2) for 12VDC/2A output, power button, 2 x MDI
- 2 x DB9 for full RS232
- 1 x DB9 for full RS232/422/485 (RI, 5V/0.5A, 12V/0.5A)
- 1 x DB15
 - 1 x Isolated CANBus 2.0B
 - 1 x GPS DR (optional)
 - 4 x DI and 4 x DO
- 4 x SMA antennas
- 4 x USB 3.1 type A (5V/1A)

Power Management & Software Support

- Selectable boot-up & shut-down voltage for low power protection by software
- Setting 8-level power on/off delay time by software
- Support S3/S4 suspend mode
- 10~255 seconds WDT support, setup by software
- SDK (Windows/Linux) including utility and sample code

Operating System

- Windows 10/Linux/YOCTO (by request)

Dimensions

- 260 x 256 x 90.1 (W x D x H) (mm)

Weight

- 5.8kg

Environment

- Operating temperatures
 - -20°C~60°C (w/industrial SSD) with air flow
- Storage temperatures: -40°C~80°C
- Relative humidity: 90% (non-condensing)
- Vibration (random)
 - 2g@5~500 Hz (in operation, SSD)
- Vibration (SSD)
 - Operating: MIL-STD-810G, Method 514.6, Category 4, common carrier US highway truck vibration exposure
 - Storage: MIL-STD-810G, Method 514.6, Category 24, minimum integrity test
- Shock (SSD)
 - Operating: MIL-STD-810G, Method 516.6, Procedure I, functional shock=40g
 - Non-operating: MIL-STD-810G, Method 516.6, Procedure V, crash hazard shock test=75g

Certifications

- CE approval
- FCC Class A
- E13 Mark

Connector Numbering

The following diagrams indicate the numbers of the connectors. Use these numbers to locate the connectors' respective pinout assignments on chapter 2 of the manual.

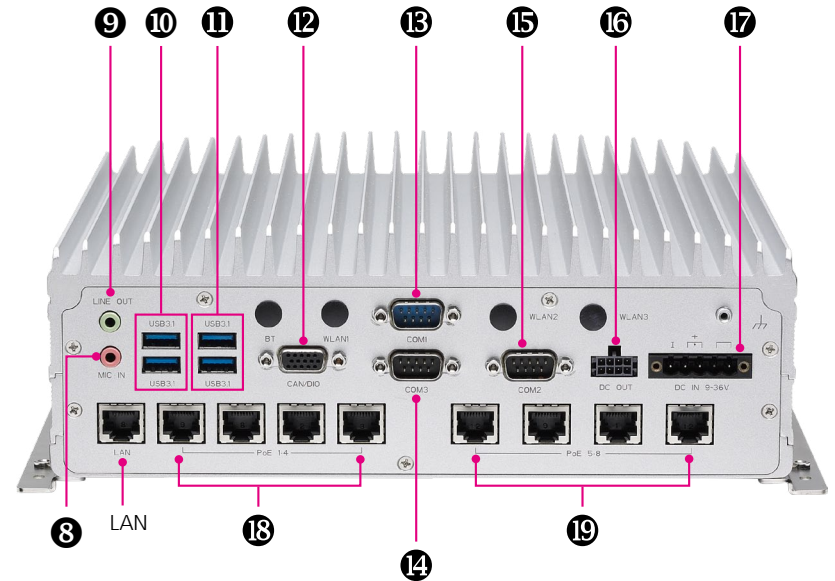
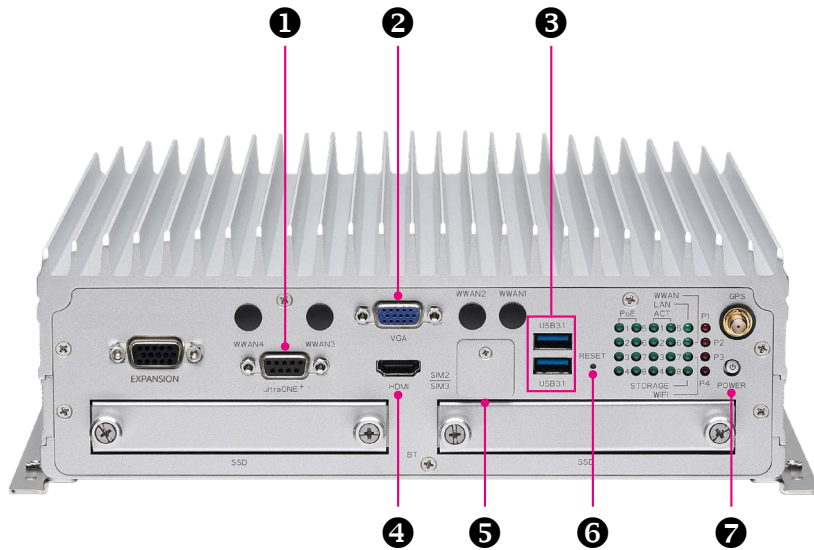

CHAPTER 2: EXTERNAL CONNECTORS PINOUT DESCRIPTION

ultraONE+ Connector

Connector number: 1

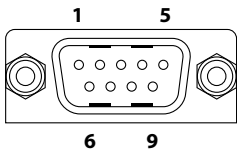

Pin	Definition	Pin	Definition
1	USB D-	2	GND
3	FPT LINKIII D-	4	POWER BUTTON
5	24V	6	USB D+
7	FPT LINKIII D+	8	24V ENABLE DETECT
9	GND		

VGA Connector

Connector number: 2

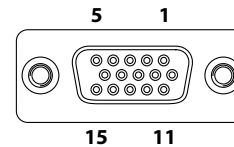

Pin	Definition	Pin	Definition
1	VGA_RED	2	VGA_GREEN
3	VGA_BLUE	4	NC
5	GND	6	GND
7	GND	8	GND
9	+5V	10	GND
11	NC	12	VGA_DATA
13	VGA_HS	14	VGA_VS
15	VGA_CLK		

Dual USB 3.1 Port

Connector number: 3

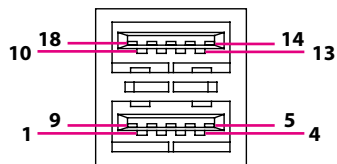

Pin	Definition	Pin	Definition
1	5V	2	USB_1N
3	USB_1P	4	GND
5	USB3_RX1N	6	USB3_RX1P
7	GND	8	USB3_TX1N
9	USB3_TX1P	10	5V
11	USB_2N	12	USB_2P
13	GND	14	USB3_RX2N
15	USB3_RX2P	16	GND
17	USB3_TX2N	18	USB3_TX2P

HDMI Connector

Connector number: 4

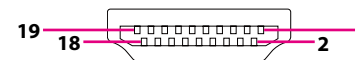

Pin	Definition	Pin	Definition
1	HDMI_TX2P	2	GND
3	HDMI_TX2N	4	HDMI_TX1P
5	GND	6	HDMI_TX1N
7	HDMI_TX0P	8	GND
9	HDMI_TX0N	10	HDMI_CLK_P
11	GND	12	HDMI_CLK_N
13	NC	14	NC
15	HDMI_SCL	16	HDMI_SDA
17	GND	18	HDMI_P5V
19	HDMI_HPD		

SIM2 and SIM3 Sockets

Connector number: 5

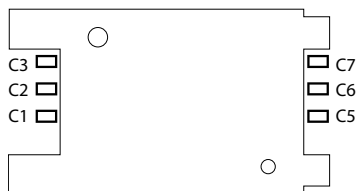

SIM2

Pin	Definition	Pin	Definition
C1	UIM_PWR	C5	NC
C2	UIM_RST	C6	UIM_DAT
C3	UIM_CLK	C7	NC

SIM3

Pin	Definition	Pin	Definition
C1	UIM_PWR	C5	NC
C2	UIM_RST	C6	UIM_DAT
C3	UIM_CLK	C7	SIM SELECT

Reset Button

Connector number: 6

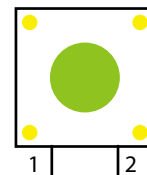

Pin	Definition
1	GND
2	RST_BTN#

Power Button

Connector number: 7



Pin	Definition	Pin	Definition
1	GND	2	HW_BT#
3	HW_BT#	4	GND
A1	PWRLED_A	C1	PWRLED_C

Mic-in Connector

Connector number: 8

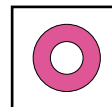

Pin	Definition	Pin	Definition
1	GND	2	MIC RIGHT
3	GND	4	MIC DETECT
5	MIC LIFT		

Line-out Connector

Connector number: 9

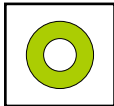

Pin	Definition	Pin	Definition
22	FRONT OUT RIGHT	23	GND
24	FRONT OUT DETECT	25	FRONT LEFT

Dual USB 3.1 Port

Connector number: 10

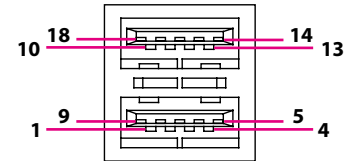

Pin	Definition	Pin	Definition
1	5V	2	USB_5N
3	USB_5P	4	GND
5	USB3_RX5N	6	USB3_RX5P
7	GND	8	USB3_TX5N
9	USB3_TX5P	10	5V
11	USB_6N	12	USB_6P
13	GND	14	USB3_RX6N
15	USB3_RX6P	16	GND
17	USB3_TX6N	18	USB3_TX6P

Dual USB 3.1 Port

Connector number: 11

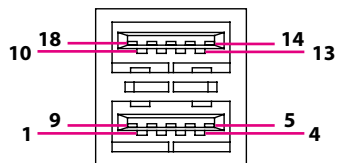

Pin	Definition	Pin	Definition
1	5V	2	USB_3N
3	USB_3P	4	GND
5	USB3_RX3N	6	USB3_RX3P
7	GND	8	USB3_TX3N
9	USB3_TX3P	10	5V
11	USB_4N	12	USB_4P
13	GND	14	USB3_RX4N
15	USB3_RX4P	16	GND
17	USB3_TX4N	18	USB3_TX4P

CAN/DIO Multiport Connector

Connector number: 12

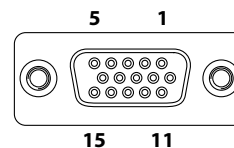

Pin	Definition	Pin	Definition
1	CAN H	2	ODOMETER
3	GPO3	4	GPI1
5	GPO0	6	CAN L
7	DIRECTION	8	GND
9	GPI2	10	GPO1
11	CAN GND	12	GND
13	GPI3	14	GPO2
15	GPI0		

COM1 RS232 Connector

Connector number: 13

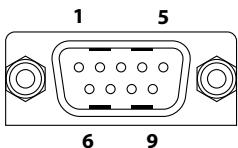

Pin	Definition	Pin	Definition
1	DCD1	2	RXD1
3	TXD1	4	DTR1
5	GND	6	DSR1
7	RTS1	8	CTS1
9	RI1		

COM3 RS-232/RS422/RS485 Connector

Connector number: 14

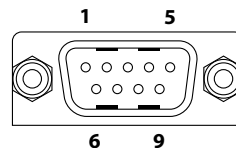

Pin	Definition	Pin	Definition
1	RS232 DCD#/RS422 TX- / RS485_DATA-	2	RS232 RX/RS422_TX+ / RS485_DATA+
3	RS232 TX/RS422_RX+	4	RS232 DTR#/RS422_RX-
5	GND	6	DSR#
7	RTS#	8	CTS#
9	RI#/12V/5V		

COM2 RS232 Connector

Connector number: 15

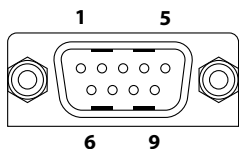

Pin	Definition	Pin	Definition
1	DCD2	2	RXD2
3	TXD2	4	DTR2
5	GND	6	DSR2
7	RTS2	8	CTS2
9	RI2		

DC Out Connector

Connector number: 16

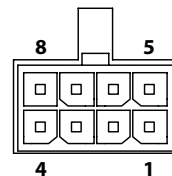

Pin	Definition	Pin	Definition
1	RESET BUTTON##	2	SLEEP BUTTON##
3	GND	4	GND
5	RS232 TX	6	RS232 RX
7	POWER BUTTON#	8	12V

9V-36V DC Power Input

Connector number: 17

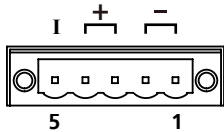

Pin	Definition	Pin	Definition
1	GND	2	GND
3	VIN	4	VIN
5	IGNITION		

PoE1 to PoE4 Ports

Connector number: 18

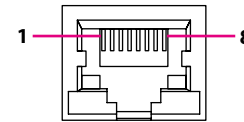

Pin	Definition	Pin	Definition
1	LANX_MDI_0P	2	LANX_MDI_0N
3	LANX_MDI_1P	4	LANX_MDI_2P
5	LANX_MDI_2N	6	LANX_MDI_1N
7	LANX_MDI_3P	8	LANX_MDI_3N

Red 'X' denotes the port number.

PoE5 to PoE8 Ports

Connector number: 19

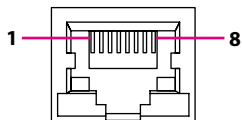

Pin	Definition	Pin	Definition
1	LANX_MDI_0P	2	LANX_MDI_0N
3	LANX_MDI_1P	4	LANX_MDI_2P
5	LANX_MDI_2N	6	LANX_MDI_1N
7	LANX_MDI_3P	8	LANX_MDI_3N

Red 'X' denotes the port number.

CHAPTER 3: JUMPERS AND SWITCHES

This chapter describes how to set the jumpers on the VTC 7250 motherboard.

Before You Begin

- Ensure you have a stable, clean working environment. Dust and dirt can get into components and cause a malfunction. Use containers to keep small components separated.
- Adequate lighting and proper tools can prevent you from accidentally damaging the internal components. Most of the procedures that follow require only a few simple tools, including the following:
 - A Philips screwdriver
 - A flat-tipped screwdriver
 - A set of jewelers screwdrivers
 - A grounding strap
 - An anti-static pad
- Using your fingers can disconnect most of the connections. It is recommended that you do not use needle-nosed pliers to disconnect connections as these can damage the soft metal or plastic parts of the connectors.
- Before working on internal components, make sure that the power is off. Ground yourself before touching any internal components, by touching a metal object. Static electricity can damage many of the electronic components. Humid environment tend to have less static electricity than dry environments. A grounding strap is warranted whenever danger of static electricity exists.

Precautions

Computer components and electronic circuit boards can be damaged by discharges of static electricity. Working on the computers that are still connected to a power supply can be extremely dangerous.

Follow the guidelines below to avoid damage to your computer or yourself:

- Always disconnect the unit from the power outlet whenever you are working inside the case.
- If possible, wear a grounded wrist strap when you are working inside the computer case. Alternatively, discharge any static electricity by touching the bare metal chassis of the unit case, or the bare metal body of any other grounded appliance.
- Hold electronic circuit boards by the edges only. Do not touch the components on the board unless it is necessary to do so. Don't flex or stress the circuit board.
- Leave all components inside the static-proof packaging that they shipped with until they are ready for installation.
- Use correct screws and do not over tighten screws.

Jumper Settings

A jumper is the simplest kind of electric switch. It consists of two metal pins and a cap. When setting the jumpers, ensure that the jumper caps are placed on the correct pins. When the jumper cap is placed on both pins, the jumper is short. If you remove the jumper cap, or place the jumper cap on just one pin, the jumper is open.

Refer to the illustrations below for examples of what the 2-pin and 3-pin jumpers look like when they are short (on) and open (off).

Two-Pin Jumpers: Open (Left) and Short (Right)

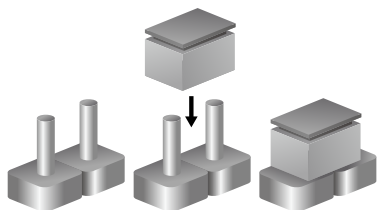

Three-Pin Jumpers: Pins 1 and 2 are Short

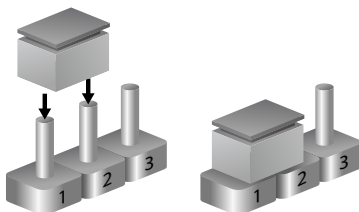

VTC 7250 System Components

The VTC 7250 consists of a motherboard and PoE board. This chapter describes the location and pinout assignment of the jumpers and connectors on each component.

Locations of the Jumpers and Connectors for the Motherboard

Top View

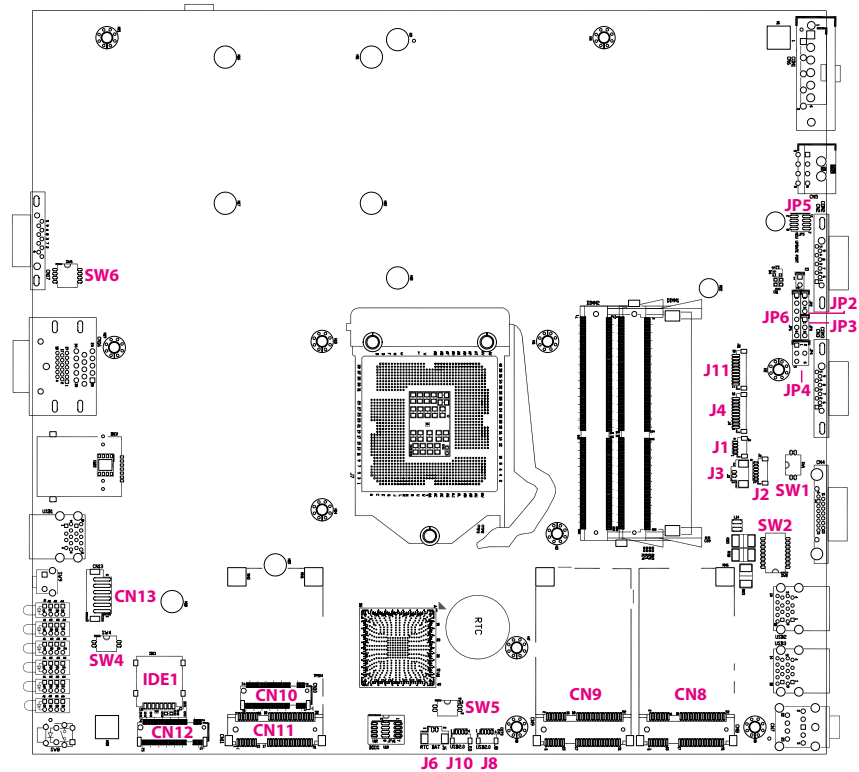

Bottom View

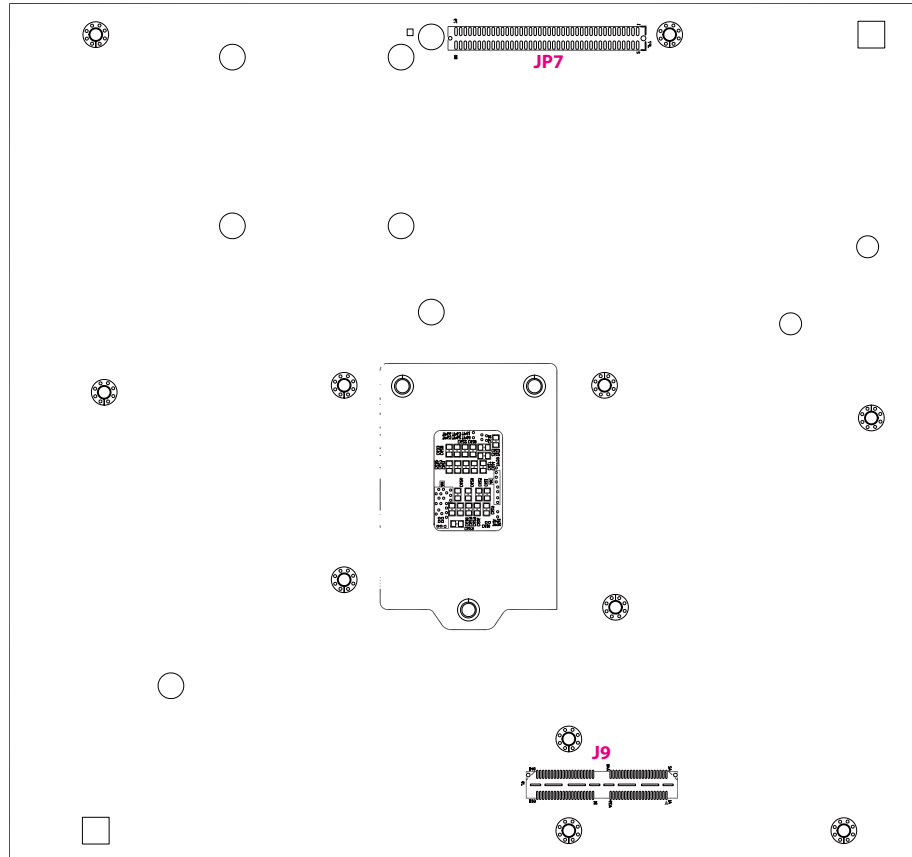

DIP Switch Settings

RTC Clear Selection

Connector location: SW5

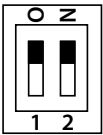

SW	RTC (Pin1)	SRTC/ME (Pin2)
OFF	Normal	Normal
ON	Clear CMOS	Clear ME

CAN Bus Impedance Control

Connector location: SW1

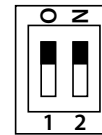

SW	RTC (Pin1)	SRTC/ME (Pin2)
1~2 ON	120 OHM	1~2 ON
1~2 OFF	Non	1~2 OFF

Input Voltage Setup Selection

Connector location: SW4

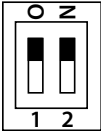

POWERSW (Pin1)	12V24V (Pin2)	Result
OFF	OFF	12V
OFF	ON	24V
ON	ON	9~36V

LVDS Resolution Control

Connector location: SW6

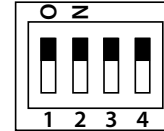

SW [3:0]	Function
0000	800 x 600 18-bit Single Port
0001	1024 x 768 18-bit Single Port
0010	1024 x 768 24-bit Single Port
0011	1280 x 768 18-bit Single Port
0100	1280 x 800 18-bit Single Port
0101	1280 x 960 18-bit Single Port
0110	800 x 480 18-bit Single Port
0111	1366 x 768 18-bit Single Port
1000	1366 x 768 24-bit Single Port

GPIO Pull High Selection Switch

Connector location: SW2

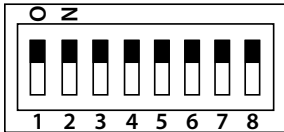

Pin	ON	OFF
1	GPI1 Internal Pull High (Default)	External Pull High
2	GPI2 Internal Pull High (Default)	External Pull High
3	GPI3 Internal Pull High (Default)	External Pull High
4	GPI4 Internal Pull High (Default)	External Pull High
5	GPO1 Internal Pull High (Default)	External Pull High
6	GPO2 Internal Pull High (Default)	External Pull High
7	GPO3 Internal Pull High (Default)	External Pull High
8	GPO4 Internal Pull High (Default)	External Pull High

Internal Connectors

COM1 RS232 DB9 Connector

Connector size: 1 x 10 = 10-pin header (1.0mm)

Connector location: J11



Pin	Definition	Pin	Definition
1	GND	2	GND
3	CTS1	4	DSR1
5	DTR1	6	RXD1
7	RI1	8	RTS1
9	TXD1	10	DCD1

SIM Card Slot

Connector location: IDE1

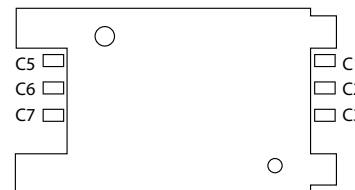

Pin	Definition	Pin	Definition
C1	UIM_PWR	C5	NC
C2	UIM_RST	C6	UIM_DAT
C3	UIM_CLK	C7	NC

GPS Wire to Board Connector

Connector size: 1 x 6 = 6-pin header

Connector location: J2

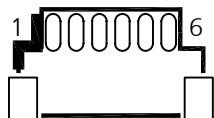

Pin	Definition	Pin	Definition
1	3.3V	2	GPS LED
3	TX	4	RX
5	GND	6	3.3V

GPS Wire to Board Connector

Connector size: 1 x 4 = 4-pin header

Connector location: J1

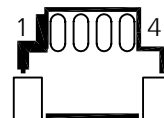

Pin	Definition	Pin	Definition
1	GND	2	NC
3	ODOMETER	4	DIRECTION

GPS Battery Connector

Connector size: 1 x 2 = 2-pin header

Connector location: J3

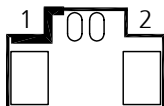

Pin	Definition
1	GND
2	VBAT

RTC Battery Connector

Connector size: 1 x 2 = 2-pin header

Connector location: J6

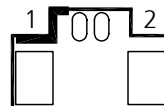

Pin	Definition
1	GND
2	VBAT

RTC Battery Connector

Connector size: 1 x 6 = 6-pin header

Connector location: CN13

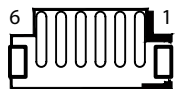

Pin	Definition	Pin	Definition
1	GND	2	FAN1 CONTROL
3	FAN1 SPEED	4	GND
5	FAN2 SPEED	6	FAN2 CONTROL

Debug 80 Port Connector

Connector size: 1 x 10 = 10-pin header (1.0mm)

Connector location: J4

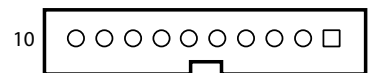

Pin	Definition	Pin	Definition
1	GND	2	PCIRST#
3	33M_CLK	4	LPC_FRAME#
5	LPC_AD3	6	LPC_AD2
7	LPC_AD1	8	LPC_AD0
9	VCC3	10	VCC3

USB Connectors (Reserved)

Connector size: 1 x 4 = 4-pin header (1.0mm)

Connector location: J8 and J10

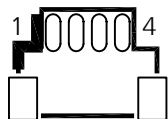

Pin	Definition	Pin	Definition
1	VCC	2	D-
3	D+	4	GND

CAN-MCU Update Port

Connector size: 1 x 6 = 6-pin header (2.54mm)

Connector location: JP6

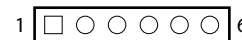

Pin	Definition	Pin	Definition
1	3.3V	2	SWDIO
3	SWDCLK	4	SWO
5	RESET#	6	GND

CAN-MCU Debug Port

Connector size: 1 x 3 = 3-pin header (2.54mm)

Connector location: JP3

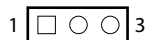

Pin	Definition
1	TX
2	RX
3	GND

MCU Debug Port

Connector size: 1 x 3 = 3-pin header (2.54mm)

Connector location: JP2

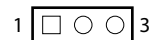

Pin	Definition
1	TX
2	RX
3	GND

MCU Download Port

Connector size: 2 x 4 = 8-pin header (1.27mm)

Connector location: JP5

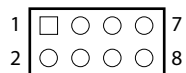

Pin	Definition	Pin	Definition
1	3.3V	2	MCU_TRST
3	MCU_TCK	4	MCU_TDO
5	MCU_RST	6	MCU_TDI
7	MCU_TMS	8	GND

COM3 RI/12V/5V Select Jumper

Connector size: 2 x 3 = 6-pin header

Connector location: JP4

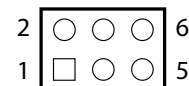

Pin	Definition
3-1	12V
3-4	RI
3-5	5V

Mini-PCIe for USB/PCIe/mSATA

Connector location: CN8

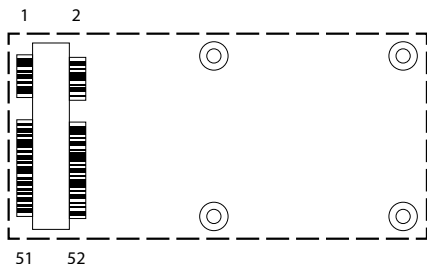

Pin	Definition	Pin	Definition
1	NC	2	+V3.3_MINI_2
3	NC	4	GND
5	NC	6	+V1.5S_MINI_2
7	CLKREQ#2	8	NC
9	GND	10	NC
11	MINICARD2_CN	12	NC
13	MINICARD2_CP	14	NC
15	GND	16	NC
17	NC	18	GND
19	NC	20	MINIPCI2_DIS#
21	GND	22	MINIPCI2_RST#
23	PCIE_RXP17_SATA_RXP4_R	24	+V3.3_MINI_2
25	PCIE_RXN17_SATA_RXN4_R	26	GND

Pin	Definition	Pin	Definition
27	GND	28	+V1.5S_MINI_2
29	GND	30	W_SM2_C
31	PCIE_TXN17_SATA_TXN4_C	32	W_SM2_D
33	PCIE_TXP17_SATA_TXP4_C	34	GND
35	GND	36	USB_10N_T
37	GND	38	USB_10P_T
39	+V3.3_MINI_2	40	GND
41	+V3.3_MINI_2	42	NC
43	GND	44	MINIPCI2_WLAN_LED#_R
45	NC	46	NC
47	NC	48	+V1.5S_MINI_2
49	NC	50	GND
51	SSD4_DETECT	52	+V3.3_MINI_2

Mini-PCIe for USB/PCIe

Connector location: CN9

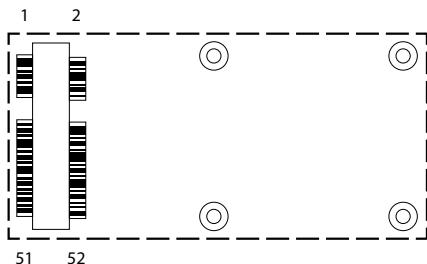

Pin	Definition	Pin	Definition
1	NC	2	+V3.3_MINI_3
3	NC	4	GND
5	NC	6	+V1.5S_MINI_3
7	CLKREQ#3	8	NC
9	GND	10	NC
11	PCIE_CN3	12	NC
13	PCIE_CP3	14	NC
15	GND	16	NC
17	NC	18	GND
19	NC	20	MINIPCI3_DIS#
21	GND	22	MINIPCI3_RST#
23	PE_RX18N_R	24	+V3.3_MINI_3
25	PE_RX18P_R	26	GND

Pin	Definition	Pin	Definition
27	GND	28	+V1.5S_MINI_3
29	GND	30	W_SM3_C
31	PE_TX18N_C	32	W_SM3_D
33	PE_TX18P_C	34	GND
35	GND	36	USB_11N_T
37	GND	38	USB_11P_T
39	+V3.3_MINI_3	40	GND
41	+V3.3_MINI_3	42	NC
43	GND	44	MINIPCI3_WLAN_LED#_R
45	NC	46	NC
47	NC	48	+V1.5S_MINI_3
49	NC	50	GND
51	MBT_DIS#_R	52	+V3.3_MINI_3

Mini-PCIe for USB

Connector location: CN11

SIM socket: SIM 2 (default)

SIM socket: SIM 3

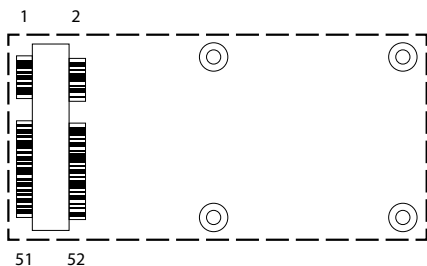

Pin	Definition	Pin	Definition
1	NC	2	+3.3V
3	NC	4	GND
5	NC	6	+1.5V
7	PCIE CLOCK REQUEST#	8	NC
9	GND	10	NC
11	PCIE_CLKN3	12	NC
13	PCIE_CLKP3	14	NC
15	GND	16	NC
17	NC	18	GND
19	NC	20	PCIE3 DISABLE#
21	GND	22	PCIE3 RESET#
23	PCIE_RXP3	24	+3.3V
25	PCIE_RXN3	26	GND

Pin	Definition	Pin	Definition
27	GND	28	+1.5V
29	GND	30	SMB_CLK
31	PCIE_TXN3	32	SMB_DATA
33	PCIE_TXP3	34	GND
35	GND	36	USB_5N
37	GND	38	USB_5P
39	+3.3V	40	GND
41	+3.3V	42	NC
43	GND	44	PCIE3_WLAN_LED#
45	NC	46	NC
47	NC	48	+1.5V
49	NC	50	GND
51	BT DISABLE#	52	+3.3V

M.2 B-Key for USB 3.0 + USB 2.0 (Reserved)

Connector location: CN10

SIM socket: SIM 2 (default)

SIM socket: SIM 3

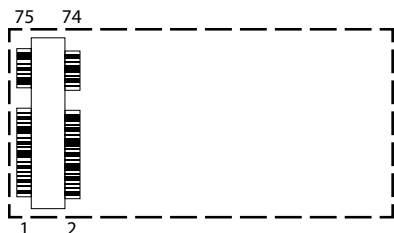

Pin	Definition	Pin	Definition
1	CONFIG3	2	3.3V
3	GND	4	3.3V
5	GND	6	POWER_OFF#
7	USB_9P_T	8	W1_DIS#
9	USB_9N_T	10	MINICARD1_WWAN_LED#
11	NC	20	NC
21	CONFIG0	22	NC
23	SMS_RI_3.5G_R	24	NC
25	NC	26	W2_DIS#
27	GND	28	NC
29	USB3_RXN9_T	30	SW2_RST
31	USB3_RXP9_T	32	SW2_CLK
33	GND	34	SW2_DAT
35	USB3_TXN9_T	36	SW2_PWR
37	USB3_TXP9_T	38	NC
39	GND	40	NC
41	NC	42	NC

Pin	Definition	Pin	Definition
43	NC	44	NC
45	GND	46	NC
47	NC	48	NC
49	NC	50	NC
51	GND	52	NC
53	NC	54	NC
55	NC	56	SMB_DATA
57	GND	58	SMB_CLK
59	NC	60	NC
61	NC	62	NC
63	NC	64	NC
65	NC	66	NC
67	RESET#	68	NC
69	CONFIG1	70	3.3V
71	GND	72	3.3V
73	GND	74	3.3V
75	CONFIG2		

M.2 B-Key for USB 3.0 + USB 2.0

Connector location: CN12

SIM socket: SIM 1 (default)

SIM socket: SIM 2

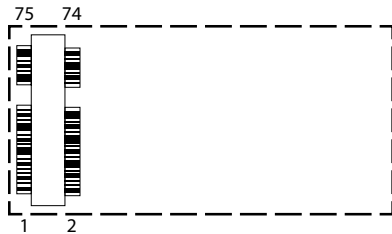

Pin	Definition	Pin	Definition
1	CONFIG3	2	3.3V
3	GND	4	3.3V
5	GND	6	POWER_OFF#
7	USB_7P_T	8	W1_DIS#
9	USB_7N_T	10	LTE_LED_PH
11	NA	20	NA
21	CONFIG0	22	NA
23	NA	24	NA
25	NA	26	W2_DIS#
27	GND	28	NA
29	USB3_PXN7_T	30	SW1_RST
31	USB3_PXP7_T	32	SW1_CLK
33	GND	34	SW1_DAT
35	USB3_TXN7_T	36	SW1_PWR
37	USB3_TXP7_T	38	NA
39	GND	40	NA
41	NA	42	NA

Pin	Definition	Pin	Definition
43	NA	44	NA
45	GND	46	NA
47	NA	48	NA
49	NA	50	NA
51	GND	52	NA
53	NA	54	PEWAKE#
55	NA	56	SM1_D
57	GND	58	SM1_C
59	NA	60	NA
61	NA	62	NA
63	NA	64	NA
65	NA	66	NA
67	RST#	68	SUSCLK_R
69	CONFIG1	70	3.3V
71	GND	72	3.3V
73	GND	74	3.3V
75	CONFIG2		

PoE Power & Low Speed Signal Connector

Connector location: JP7

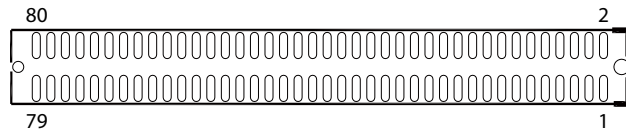

Pin	Definition	Pin	Definition
1	GND	2	VIN_M
3	GND	4	VIN_M
5	GND	6	VIN_M
7	GND	8	VIN_M
9	GND	10	VIN_M
11	GND	12	VIN_M
13	GND	14	VIN_M
15	GND	16	VIN_M
17	NC	18	NC
19	NC	20	NC
21	GND	22	V3.3ALW
23	MCU_I2C1_SCL	24	V3.3ALW
25	MCU_I2C1_SDA	26	EXP_ID_1
27	GND	28	EXP_ID_2
29	PCH_SMB_CLK	30	EXP_ID_3
31	PCH_SMB_DATA	32	EXP_ID_4
33	GND	34	SLP_S3#
35	VCC3_POK	36	SLP_S5#
37	VCC_EN	38	EXP_POE_POK
39	MB_MCU_PSE_PWREN	40	WAKE_ON_LAN_EN

Pin	Definition	Pin	Definition
41	MB_MCU_PSEA_RST	42	LAN_WAEK_N
43	MB_MCU_PSEB_RST	44	PLTRST#_POE
45	IO_USB_PWR_EN	46	GND
47	LAN_POE_LED0	48	LAN10G_ACTIVE_LED0
49	LAN_POE_LED1	50	LAN_ACTIVE_LED1
51	LAN_POE_LED2	52	LAN_ACTIVE_LED2
53	LAN_POE_LED3	54	LAN_ACTIVE_LED3
55	LAN_POE_LED4	56	LAN_ACTIVE_LED4
57	LAN_POE_LED5	58	LAN_ACTIVE_LED5
59	LAN_POE_LED6	60	LAN_ACTIVE_LED6
61	LAN_POE_LED7	62	LAN_ACTIVE_LED7
63	POE_PW_ERR#	64	V3P3_LAN1
65	NC	66	LAN_ACTIVE_LED8
67	POE_INSERT#	68	GND
69	SIO_AGND	70	USB_13N
71	POE_THER	72	USB_13P
73	GND	74	GND
75	USB_12N	76	USB_14N
77	USB_12P	78	USB_14P
79	GND	80	GND

PoE High Speed Signal Connector

Connector location: J9

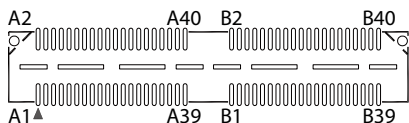

Pin	Definition	Pin	Definition
A1	PCIE_RXP5	A2	PCIE_TXP5
A3	PCIE_RXN5	A4	PCIE_TXN5
A5	GND	A6	GND
A7	PCIE_RXP6	A8	PCIE_TXP6
A9	PCIE_RXN6	A10	PCIE_TXN6
A11	GND	A12	GND
A13	PCIE_RXP7	A14	PCIE_TXP7
A15	PCIE_RXN7	A16	PCIE_TXN7
A17	GND	A18	GND
A19	PCIE_RXP8	A20	PCIE_TXP8
A21	PCIE_RXN8	A22	PCIE_TXN8
A23	GND	A24	GND
A25	PCIE_RXP14	A26	PCIE_TXP14
A27	PCIE_RXN14	A28	PCIE_TXN14
A29	GND	A30	GND
A31	PCIE_RXP15	A32	PCIE_TXP15
A33	PCIE_RXN15	A34	PCIE_TXN15
A35	GND	A36	GND
A37	PCIE_RXP16	A38	PCIE_TXP16
A39	PCIE_RXN16	A40	PCIE_TXN16

Pin	Definition	Pin	Definition
B1	PCIE_RXP21	B2	PCIE_TXP21
B3	PCIE_RXN21	B4	PCIE_TXN21
B5	GND	B6	GND
B7	PCIE_RXP22	B8	PCIE_TXP22
B9	PCIE_RXN22	B10	PCIE_TXN22
B11	GND	B12	GND
B13	PCIE_RXP23	B14	PCIE_TXP23
B15	PCIE_RXN23	B16	PCIE_TXN23
B17	GND	B18	GND
B19	PCIE_RXP24	B20	PCIE_TXP24
B21	PCIE_RXN24	B22	PCIE_TXN24
B23	GND	B24	GND
B25	PCIE_CLKP5	B26	PCIE_CLKP14
B27	PCIE_CLKN5	B28	PCIE_CLKN14
B29	GND	B30	GND
B31	SATA_TXP0B	B32	SATA_TXP0A
B33	SATA_TXN0B	B34	SATA_TXN0A
B35	GND	B36	GND
B37	SATA_RXN0B	B38	SATA_RXN0A
B39	SATA_RXP0B	B40	SATA_RXP0A

Locations of the Jumpers and Connectors for the PoE Expansion Module (VIOB-POE8-03)

Top View

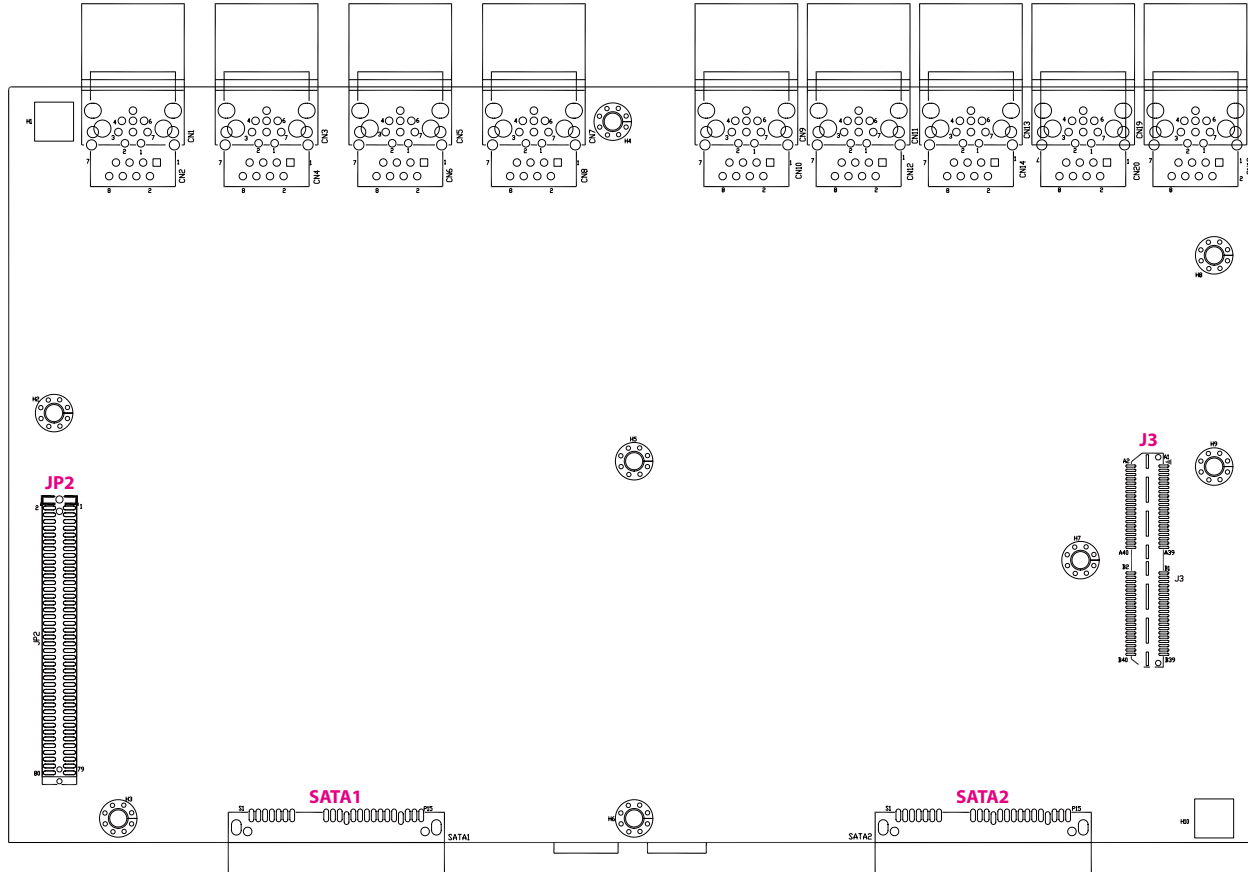

Internal Connectors

SATA Connectors (7-pin and 15-pin)

Connector type: Standard Serial ATA 7P and 15P

Connector location: SATA1 & SATA2

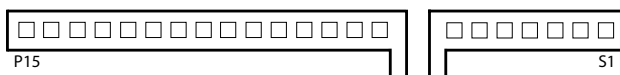

Pin	Definition	Pin	Definition
S1	GND	S2	SATA_TXP
S3	SATA_TXN	S4	GND
S5	SATA_RXN	S6	SATA_RXP
S7	GND	P1	NC
P2	NC	P3	NC
P4	GND	P5	GND
P6	GND	P7	VCC5
P8	VCC5	P9	VCC5
P10	GND	P11	NC
P12	GND	P13	NC
P14	NC	P15	NC

Low Speed Board to Board Connector

Connector location: JP2

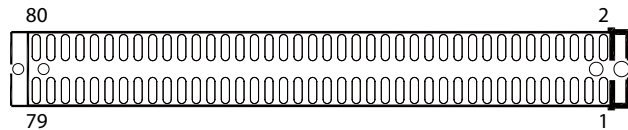

Pin	Definition	Pin	Definition
1	VIN_M(9-36V)	2	GND
3	VIN_M(9-36V)	4	GND
5	VIN_M(9-36V)	6	GND
7	VIN_M(9-36V)	8	GND
9	VIN_M(9-36V)	10	GND
11	VIN_M(9-36V)	12	GND
13	VIN_M(9-36V)	14	GND
15	VIN_M(9-36V)	16	GND
17	NC	18	NC
19	NC	20	NC
21	+V3.3ALW	22	GND
23	+V3.3ALW	24	MCU_I2C3_SCL_M
25	EXP_ID_1	26	MCU_I2C3_SDA_M
27	EXP_ID_2	28	GND
29	EXP_ID_3	30	SMB_CLK
31	EXP_ID_4	32	SMB_DATA
33	PM_SLP_S3#	34	GND
35	PM_SLP_S5#	36	VCC3_POK
37	EXP_POE_ALLPOK	38	VCC_EN
39	WAKE_ON_LAN_EN	40	MB_MCU_PSE_PWREN

Pin	Definition	Pin	Definition
41	LAN_WAEK_N	42	MB_MCU_PSEA_RST
43	PMU_PLTRST#	44	MB_MCU_PSEB_RST
45	GND	46	IO_USB_PWR_EN
47	LAN_10G_ACT#	48	POE1_LED#
49	LAN1_1G_ACT#	50	POE2_LED#
51	LAN2_1G_ACT#	52	POE3_LED#
53	LAN3_1G_ACT#	54	POE4_LED#
55	LAN4_1G_ACT#	56	POE5_LED#
57	LAN5_1G_ACT#	58	POE6_LED#
59	LAN6_1G_ACT#	60	POE7_LED#
61	LAN7_1G_ACT#	62	POE8_LED#
63	V3P3_LAN1	64	POE_ERRLED#
65	NC	66	NC
67	GND	68	GND
69	USB_13N	70	X550_THERM-DN
71	USB_13P	72	X550_THERM-DP
73	GND	74	GND
75	USB_14N	76	USB_15N
77	USB_14P	78	USB_15P
79	GND	80	GND

High Speed Board to Board Connector

Connector location: J3

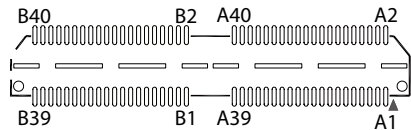

Pin	Definition	Pin	Definition
A1	PCIE_RXP5	A2	PCIE_TXP5
A3	PCIE_RXN5	A4	PCIE_TXN5
A5	GND	A6	GND
A7	PCIE_RXP6	A8	PCIE_TXP6
A9	PCIE_RXN6	A10	PCIE_TXN6
A11	GND	A12	GND
A13	PCIE_RXP7	A14	PCIE_TXP7
A15	PCIE_RXN7	A16	PCIE_TXN7
A17	GND	A18	GND
A19	PCIE_RXP8	A20	PCIE_TXP8
A21	PCIE_RXN8	A22	PCIE_TXN8
A23	GND	A24	GND
A25	PCIE_RXP14	A26	PCIE_TXP14
A27	PCIE_RXN14	A28	PCIE_TXN14
A29	GND	A30	GND
A31	PCIE_RXP15	A32	PCIE_TXP15
A33	PCIE_RXN15	A34	PCIE_TXN15
A35	GND	A36	GND
A37	PCIE_RXP16	A38	PCIE_TXP16
A39	PCIE_RXN16	A40	PCIE_TXN16

Pin	Definition	Pin	Definition
B1	PCIE_RXP21	B2	PCIE_TXP21
B3	PCIE_RXN21	B4	PCIE_TXN21
B5	GND	B6	GND
B7	PCIE_RXP22	B8	PCIE_TXP22
B9	PCIE_RXN22	B10	PCIE_TXN22
B11	GND	B12	GND
B13	PCIE_RXP23	B14	PCIE_TXP23
B15	PCIE_RXN23	B16	PCIE_TXN23
B17	GND	B18	GND
B19	PCIE_RXP24	B20	PCIE_TXP24
B21	PCIE_RXN24	B22	PCIE_TXN24
B23	GND	B24	GND
B25	PCIE_CLKP5	B26	PCIE_CLKP14
B27	PCIE_CLKN5	B28	PCIE_CLKN14
B29	GND	B30	GND
B31	SATA_TXP1	B32	SATA_TXP0
B33	SATA_TXN1	B34	SATA_TXN0
B35	GND	B36	GND
B37	SATA_RXP1	B38	SATA_RXP0
B39	SATA_RXN1	B40	SATA_RXN0

CHAPTER 4: SYSTEM SETUP

Removing the Chassis Cover



Prior to removing the chassis cover, make sure the unit's power is off and disconnected from the power sources to prevent electric shock or system damage.

1. Remove the screws on the front panel.



2. Remove the screws on the rear panel.

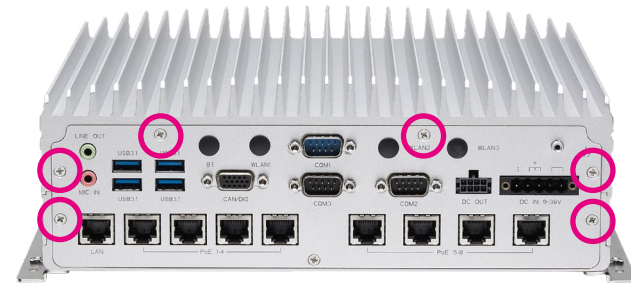

3. Remove the mounting bracket screws on the bottom of the enclosure.



4. After removing the brackets, loosen the screws on the bottom then remove the chassis top cover.



Removing the CPU

1. Locate the CPU socket and unlock the socket by pushing the load lever down, moving it sideways until it is released from the retention tab; then lift the load lever up.



Load Lever

Retention Tab

2. Lift the load plate up and remove the CPU from the socket.

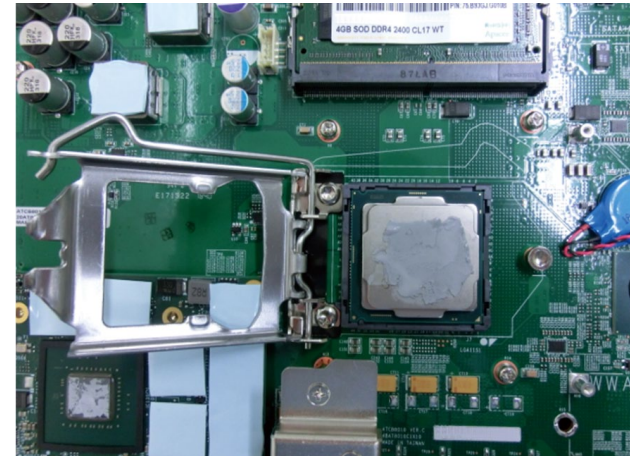

Removing the Memory Module

1. Push the ejector tabs which are at the ends of the socket outward. Then lift up the module and remove it from the socket.

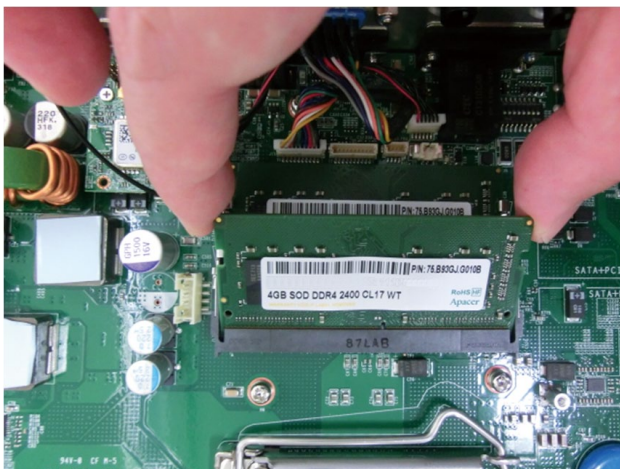

Installing a WWAN Module (Mini-PCIe)

1. Locate the WWAN Mini PCI Express slot (CN11). Insert the module into the Mini PCI Express slot at a 45 degrees angle until the gold-plated connector on the edge of the module completely disappears inside the slot. Then fasten screws into the mounting holes to secure the module.

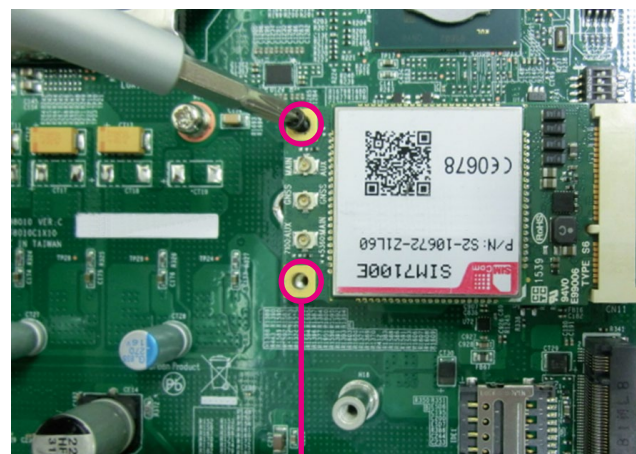

**Mounting
Screws**

Installing a WWAN Module (M.2)

1. Locate the M.2 slot (CN10). Insert the module into the M.2 slot at a 45 degrees angle until the gold-plated connector on the edge of the module completely disappears inside the slot. Then fasten a screw into the mounting hole to secure the module.

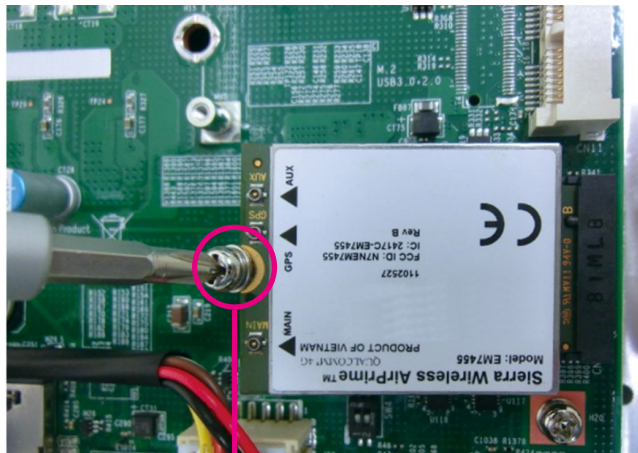

**Mounting
Screw**

Installing a WLAN Module (Half Mini-PCIe)

1. Locate the WLAN Mini PCI Express slot (CN9). Insert the module into the Mini PCI Express slot at a 45 degrees angle until the gold-plated connector on the edge of the module completely disappears inside the slot. Then fasten a screw into the mounting hole to secure the module.

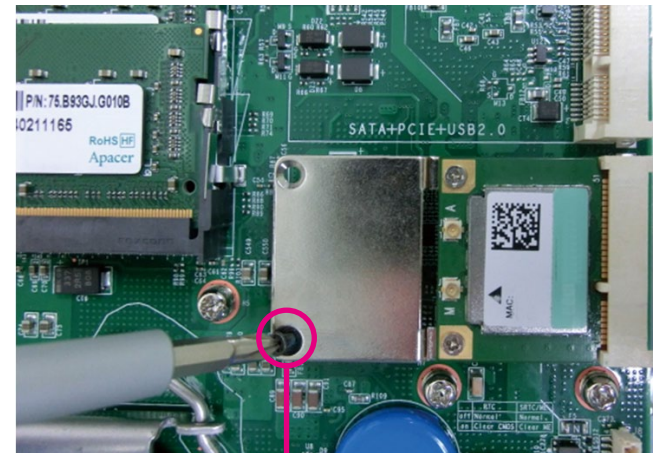

**Mounting
Screw**

Installing a SIM Card

1. Remove the SIM card cover.



2. Insert the SIM card into the SIM card slot.



3. Close the cover and secure it to the original position.

Installing a SSD/HDD Drive

1. The SSD/HDD bays on the front are used to install 2.5" hard drives. Loosen the thumb screws and remove the cover.

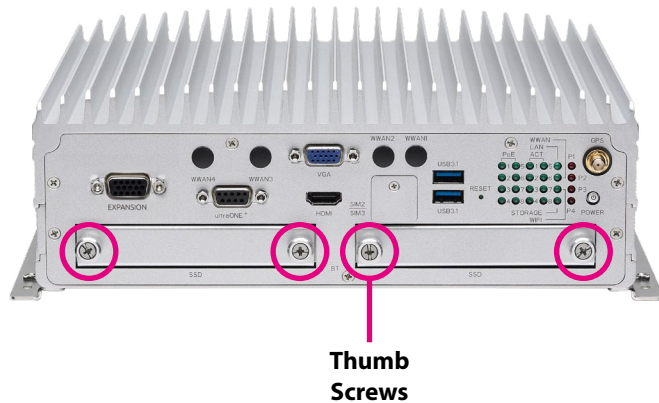

2. Place the storage drive into the drive bay with the SATA data and power connector facing towards the end. Align the storage drive's mounting holes with the mounting holes on the drive bay, and use the provided screws to secure the storage drive in place.

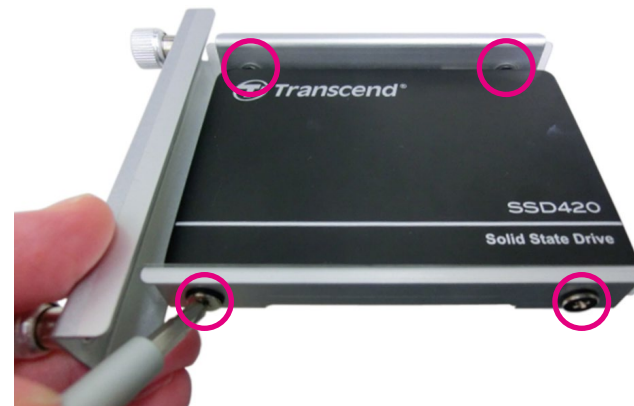

3. Insert the drive bay back to its original position and secure the thumb screws.



APPENDIX A: SOFTWARE DEMO UTILITY FOR I/O PORTS OF FUNCTION CONTROL

Menu Screen

1. Config1

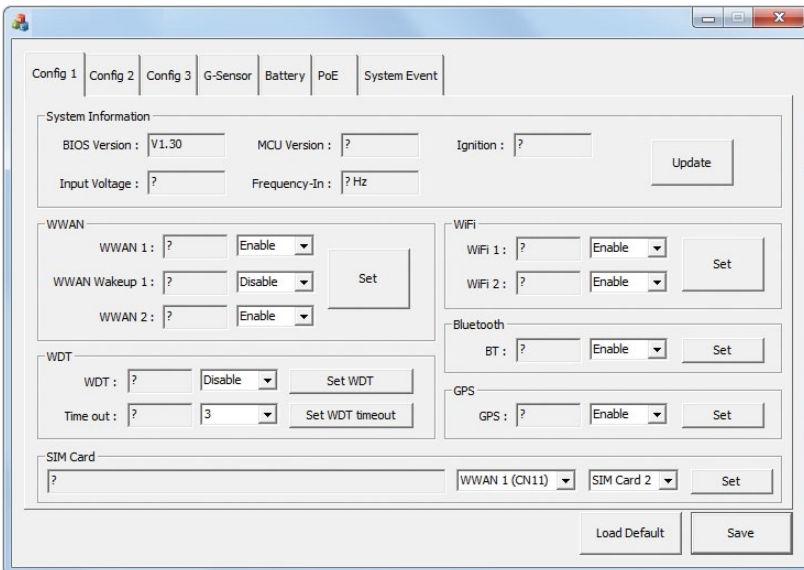

1.1 System Information

Displays basic information of the system.

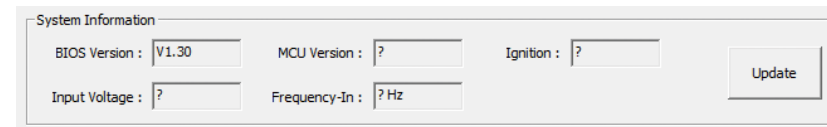

1.2 WWAN

Enables or disables the WWAN function and the wake-up function.

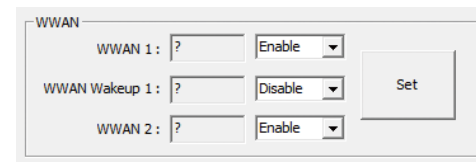

1.3 WDT

Enables or disables the watchdog function. WDT timeout timer can be configured.

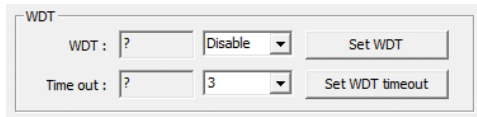

WDT

WDT : ? [Disable] [Set WDT]

Time out : ? 3 [Set WDT timeout]

1.4 WiFi

Enables or disables the WiFi function.

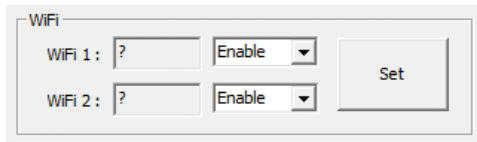

WiFi

WiFi 1 : ? [Enable] [Set]

WiFi 2 : ? [Enable]

1.5 Bluetooth

Enables or disables the Bluetooth function.

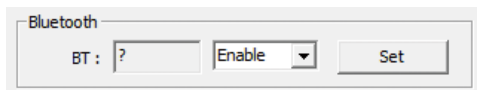

Bluetooth

BT : ? [Enable] [Set]

1.6 GPS

Enables or disables the GPS function.

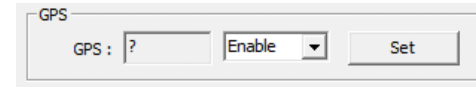

GPS

GPS : ? [Enable] [Set]

1.7 SIM Card

Selects the SIM Card for WWAN.

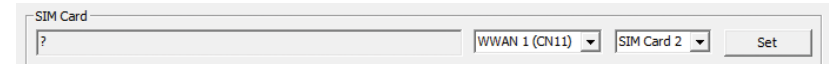

SIM Card

? [WWAN 1 (CN11)] [SIM Card 2] [Set]

2. Config2

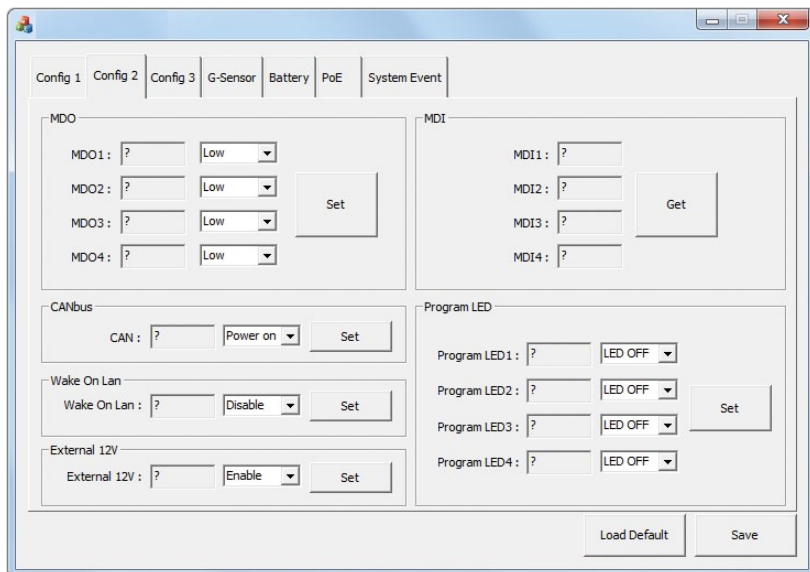

2.1 GPO

Configures GPO as high voltage level or low voltage level.

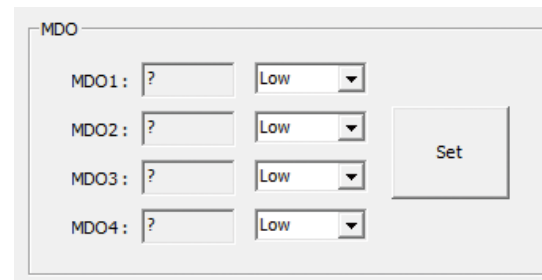

2.2 GPI

Reads the status (voltage level) of GPI.

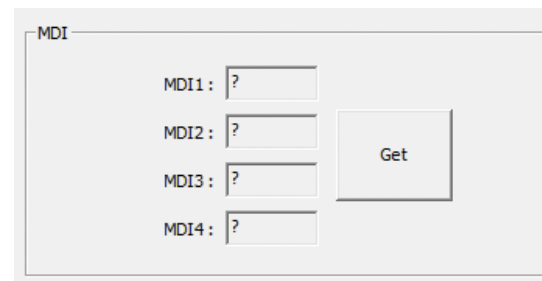

2.3 CAN Bus

Enables or disables the CAN Bus function.

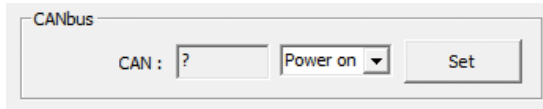

CANbus

CAN : ? Power on Set

2.4 Wake On LAN

Enables or disables the Wake On LAN function on LAN.

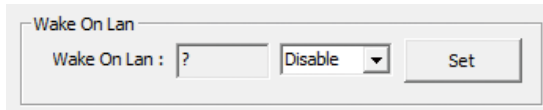

Wake On Lan

Wake On Lan : ? Disable Set

2.5 External 12V

Enables or disables the 12VDC power output.

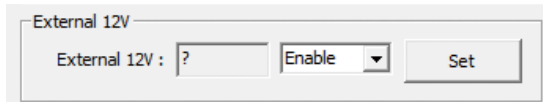

External 12V

External 12V : ? Enable Set

2.6 Programmable LED

Turns On/Off LED light.

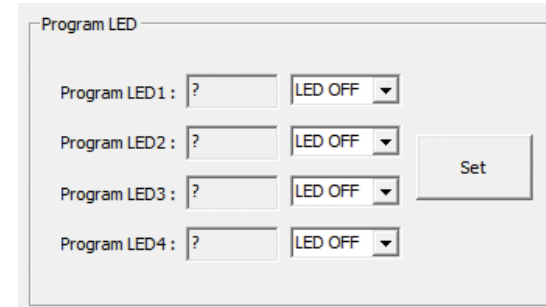

Program LED

Program LED1 : ? LED OFF

Program LED2 : ? LED OFF

Program LED3 : ? LED OFF

Program LED4 : ? LED OFF

Set

3. Config3

The screenshot shows the Config3 utility window with the following sections:

- Low Battery Voltage Protection:** Includes Voltage Level (input field with "?"), Startup/Shutdown settings for 12V and 24V (dropdowns with values 11.5V, 10.5V, 23.0V, 21.0V), and a Set button.
- Power Input Type:** Includes Power Type (input field with "?") and a Get button.
- Delay Time:** Includes Delay Off (input field with "?", Disable dropdown), Power Off (input field with "?", 20 Sec dropdown), Delay On (input field with "?", Disable dropdown), Power On (input field with "?", 10 Sec dropdown), and a Set button.
- RTC Wake Up Timer:** Includes Alarm (input field with "?", Disable dropdown) and a Set button.
- Alarm Timer:** Includes Hour (input field with "?", 0 dropdown), Min (input field with "?", 0 dropdown), Sec (input field with "?", 0 dropdown), and a Set button.
- Buttons:** Load Default and Save buttons at the bottom.

3.1 Low Battery Voltage Protection

Enables or disables low battery voltage protection function. Once it is enabled, one of 4 types of voltage levels can be selected.

This close-up shows the Low Battery Voltage Protection section with the Voltage Level input field containing "?", the Startup/Shutdown dropdowns showing values 11.5V, 10.5V, 23.0V, and 21.0V, and a Set button.

3.2 Power Type

Shows one of the following power types for input voltage:

- 12VDC
- 24VDC
- 9~36VDC

This close-up shows the Power Input Type section with the Power Type input field containing "?" and a Get button.

3.3 Delay On/Off Timer

Enables or disables the Delay On/Off function. Once this function is enabled, the delay timer can be configured.

This close-up shows the Delay Time section with Delay Off (input field with "?", Disable dropdown), Power Off (input field with "?", 20 Sec dropdown), Delay On (input field with "?", Disable dropdown), Power On (input field with "?", 10 Sec dropdown), and a Set button.

3.4 RTC Wake Up Timer

Enables or disables the RTC Wake Up function. Once this function is enabled, the timer can be configured.

This close-up shows the RTC Wake Up Timer section with Alarm (input field with "?", Disable dropdown) and a Set button. Below it, the Alarm Timer section shows Hour (input field with "?", 0 dropdown), Min (input field with "?", 0 dropdown), Sec (input field with "?", 0 dropdown), and a Set button.

4. G-Sensor

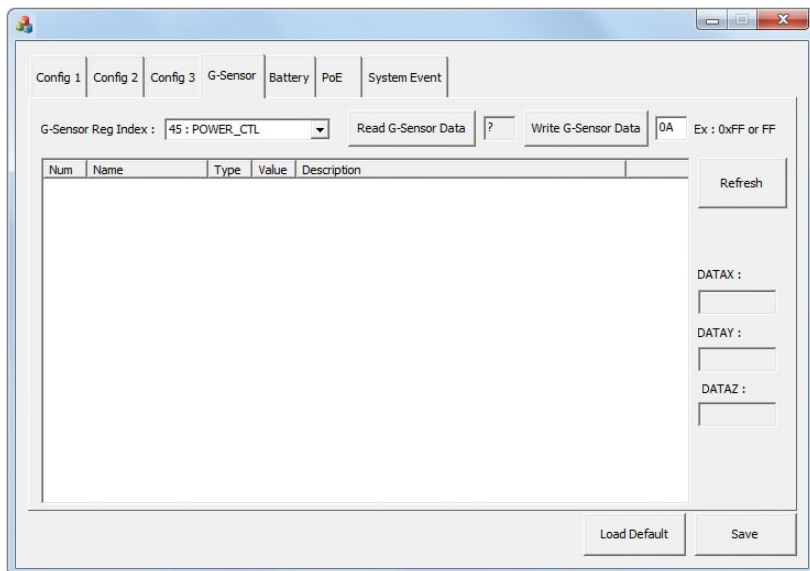

4.1 G-Sensor Registers

Selects the registers inside G-Sensor to read or write the data.

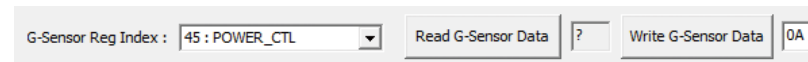

4.2 Register Table

Shows the value of all registers in G-Sensor, once the Refresh button is pressed.

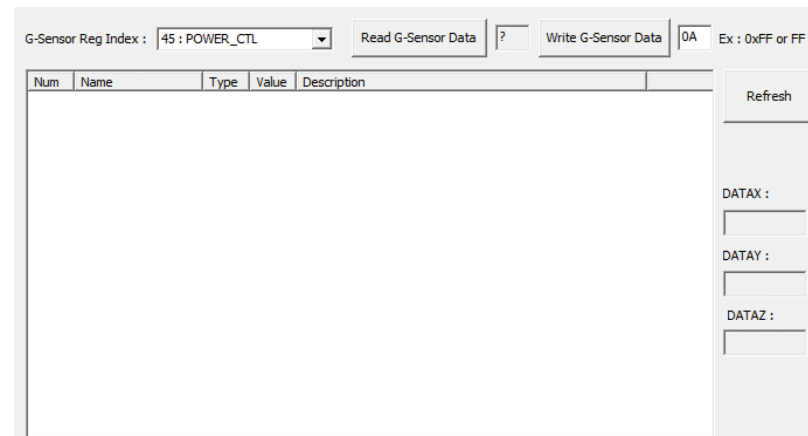

5. PoE

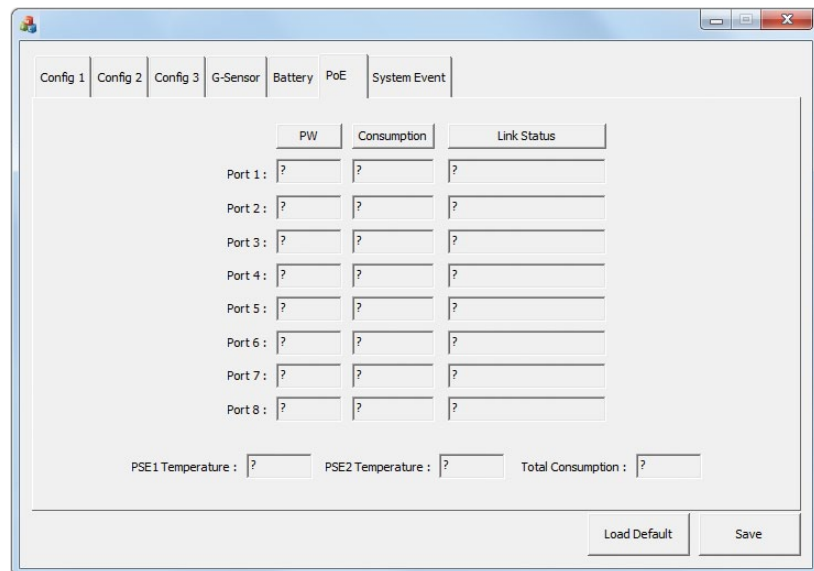

5.1 PoE

Shows the status of PoE power output.

5.2 Output (W)

Shows the power output of each PoE port.

5.3 Link Status

Shows the status of PoE link.

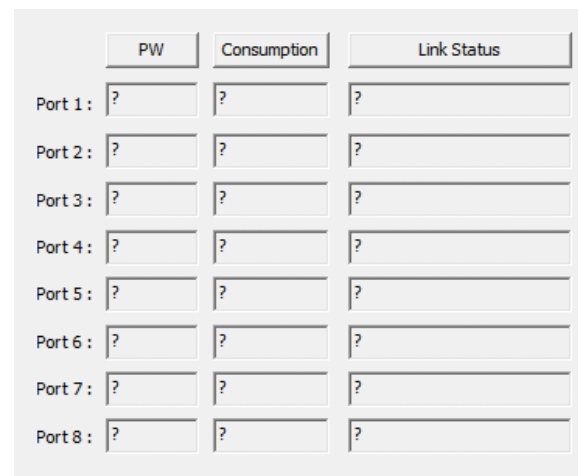

5.4 Total Output (W)

Shows the total power output of all PoE ports.



6. System Event

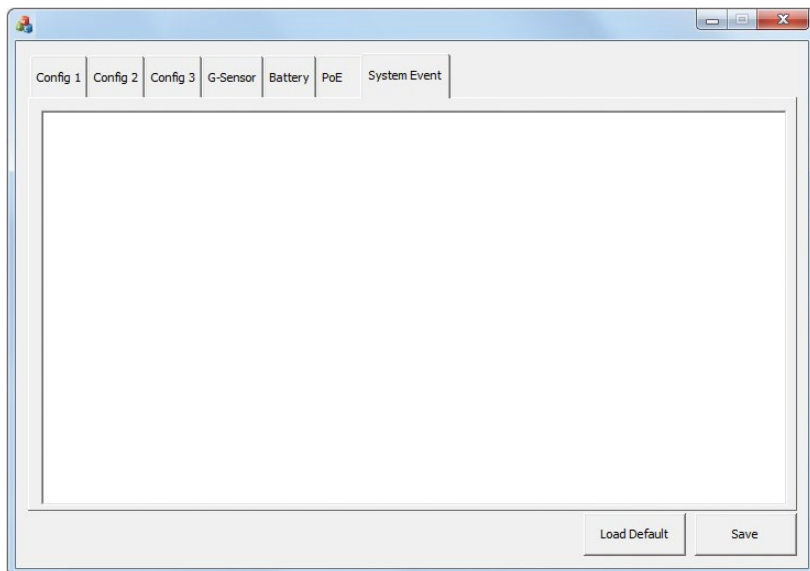

The System Event tab shows the following alarm messages:

1. Over voltage alarm
2. Lower voltage alarm
3. Over temperature alarm
4. Lower temperature alarm
5. Fan error alarm

APPENDIX B: GPS FEATURE

uBlox-NEO M8 Overview

The NEO-M8 series of standalone concurrent GNSS modules is built on the exceptional performance of the u-blox M8 GNSS (GPS, GLONASS, Galileo, BeiDou, QZSS and SBAS) engine in the industry proven NEO form factor.

The NEO-M8 series provides high sensitivity and minimal acquisition times while maintaining low system power. The NEO-M8M is optimized for cost sensitive applications, while NEO-M8N and NEO-M8Q provide best performance and easier RF integration. The NEO form factor allows easy migration from previous NEO generations. Sophisticated RF-architecture and interference suppression ensure maximum performance even in GNSS-hostile environments.

The NEO-M8 combines a high level of robustness and integration capability with flexible connectivity options. The future-proof NEO-M8N includes an internal Flash that allows simple firmware upgrades for supporting additional GNSS systems. This makes NEO-M8 perfectly suited to industrial and automotive applications.

The DDC (I²C compliant) interface provides connectivity and enables synergies with most u-blox cellular modules. For RF optimization the NEO-M8N/Q features an additional front-end LNA for easier antenna integration and a front-end SAW filter for increased jamming immunity.

u-blox M8 modules use GNSS chips qualified according to AEC-Q100, are manufactured in ISO/TS 16949 certified sites, and fully tested on a system level. Qualification tests are performed as stipulated in the ISO16750 standard: “Road vehicles – Environmental conditions and testing for electrical and electronic equipment”.

Technical Specifications

Features

Receiver type	72-channel u-blox M8 engine GPS/QZSS L1 C/A, GLONASS L10F, BeiDou B1 SBAS L1 C/A: WAAS, EGNOS, MSAS Galileo-ready E1B/C (NEO-M8N)		
Nav. update rate¹	Single GNSS: up to 18 Hz Concurrent GNSS: up to 10 Hz		
Position accuracy	2.0 m CEP		
		NEO-M8N/Q	NEO-M8M
Acquisition	Cold starts:	26 s	27 s
	Aided starts:	2 s	4 s
	Reacquisition:	1 s	1 s
Sensitivity	Tracking & Nav:	-167 dBm	-164 dBm
	Cold starts:	-148 dBm	-147 dBm
	Hot starts:	-156 dBm	-156 dBm
Assistance	AssistNow GNSS Online AssistNow GNSS Offline (up to 35 days) AssistNow Autonomous (up to 6 days) OMA SUPL & 3GPP compliant		
Oscillator	TCXO (NEO-M8N/Q), Crystal (NEO-M8M)		
RTC crystal	Built-in		
Noise figure	On-chip LNA (NEO-M8M). Extra LNA for lowest noise figure (NEO-M8N/Q)		

Features cont.

Anti jamming	Active CW detection and removal. Extra onboard SAW band pass filter (NEO-M8N/Q)
Memory	ROM (NEO-M8M/Q) or Flash (NEO-M8N)
Supported antennas	Active and passive
Odometer	Travelled distance
Data-logger	For position, velocity, and time (NEO-M8N)

¹ For NEO-M8M/Q

Electrical data

Supply voltage	1.65 V to 3.6 V (NEO-M8M) 2.7 V to 3.6 V (NEO-M8N/Q)
Power consumption²	23 mA @ 3.0 V (continuous) 5 mA @ 3.0 V Power Save Mode (1 Hz, GPS only)
Backup Supply	1.4 to 3.6 V

² NEO-M8M

Interfaces

Serial interfaces	1 UART 1 USBV2.0 full speed 12 Mbit/s 1 SPI (optional) 1 DDC (I ² C compliant)
Digital I/O	Configurable timepulse 1 EXTINT input for Wakeup
Timepulse	Configurable 0.25 Hz to 10 MHz
Protocols	NMEA, UBX binary, RTCM

VIOB-GPS-02 Module Connector Pin Definitions



J2 (GPS Side)



J9 (PC Side)

J2 Pin Definition

Pin	Definition	Pin	Definition
1	GPS_3V3	2	GND
3	GPS_TXD_M	4	GPS_RXD_M
5	NC	6	+V3.3ALW

J9 Pin Definition

Pin	Definition	Pin	Definition
1	GPS_BAT	2	GPS_LED#
3	GPS_TX	4	GPS_RX
5	GND	6	VCC3_GPS

COM Port for GPS: COM 4
Baud Rate: 9600

APPENDIX C: SIGNAL CONNECTION OF MCU DI/DO

GPIO Pinout Description

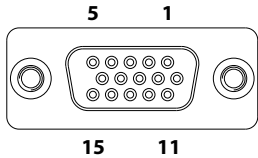

Pin	Definition	Pin	Definition
1		2	
3	GPO3	4	GPI1
5	GPO0	6	
7		8	
9	GPI2	10	GPO1
11		12	
13	GPI3	14	GPO2
15	GPI0		

Digital Input

CN12 connector for GPI signal (digital signal input). The CN12 connector has 4 digital input channels by default.

Wet Contact (default)

The SW2 switch needs to switch to “ON” state. The GPI signals have a pull up resistor to Vin Voltage internally.

The figure below shows how to connect an external source to one of the input channels.

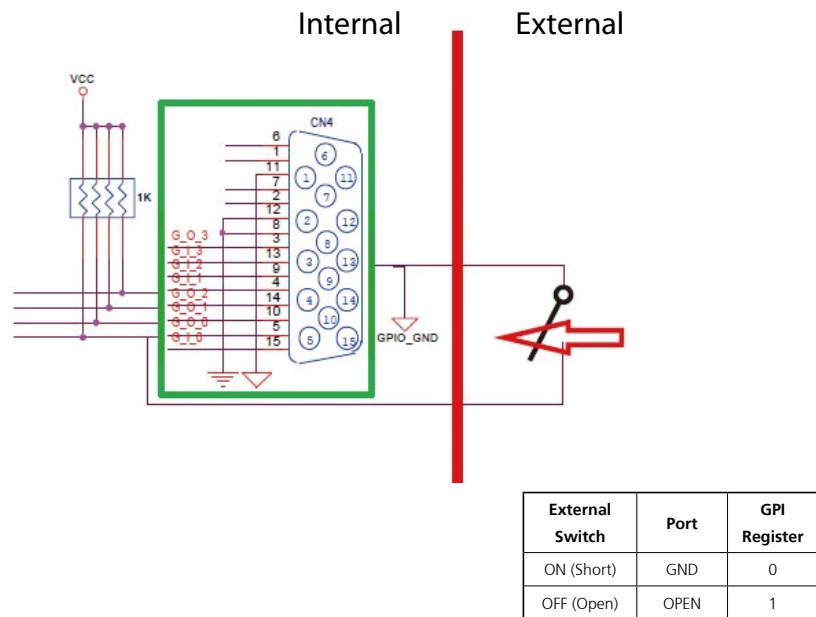

Dry Contact:

The SW2 switch needs to switch to “Low” state. The GPI signal will not have a pull up resistor internally.

The figure below shows how to connect an external source to one of the input channels.

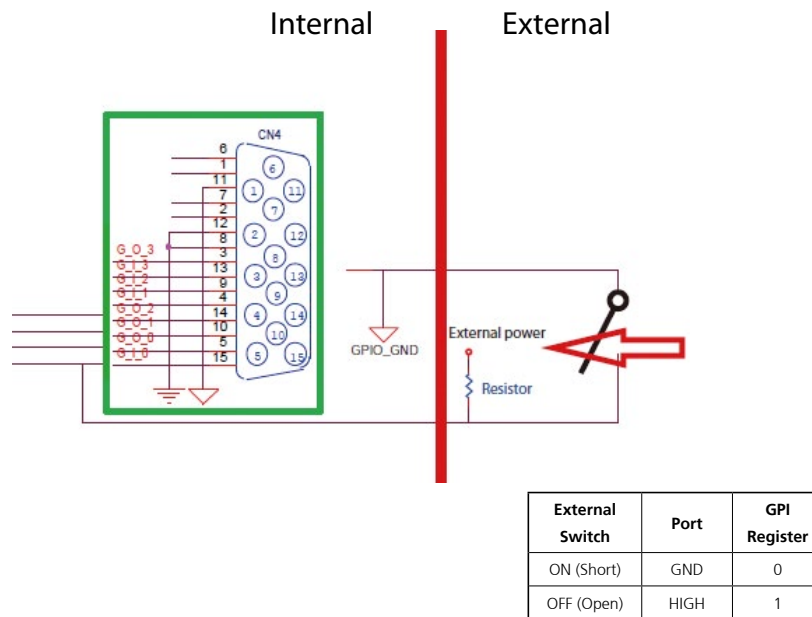

Digital Output

CN12 connector for GPO signal (digital signal output). The CN12 connector has 4 digital output channels by default.

The signal connection of CN12 supports two connected methods for output signal type. One is Low level (driven to 0V from GPO signal) other is High level (high voltage is provided from external device).

Wet Contact (default)

The SW2 switch needs to switch to “ON” state. The GPO signal will have a pull up resistor to Vin Voltage internally.

The figure below shows how to connect an external source to one of the output channels.

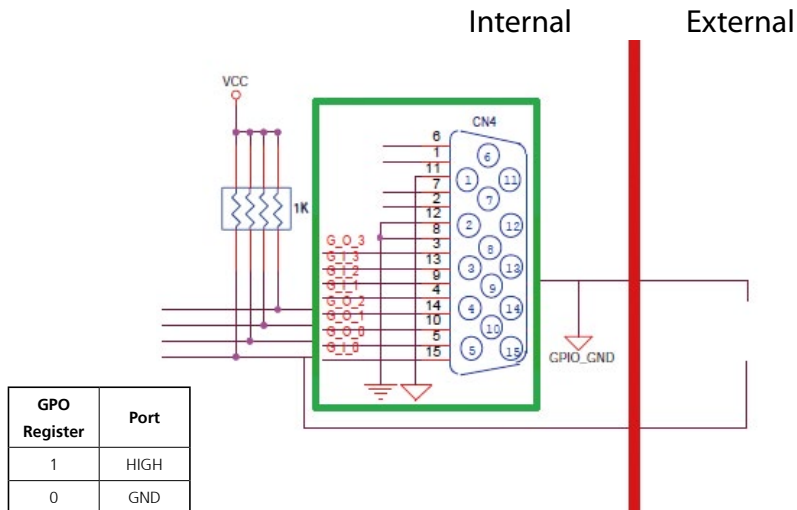

Dry Contact

The SW2 switch needs to switch to “Low” state. The GPO signal will not have a pull up resistor internally.

The figure below shows how to connect an external source to one of the output channels.

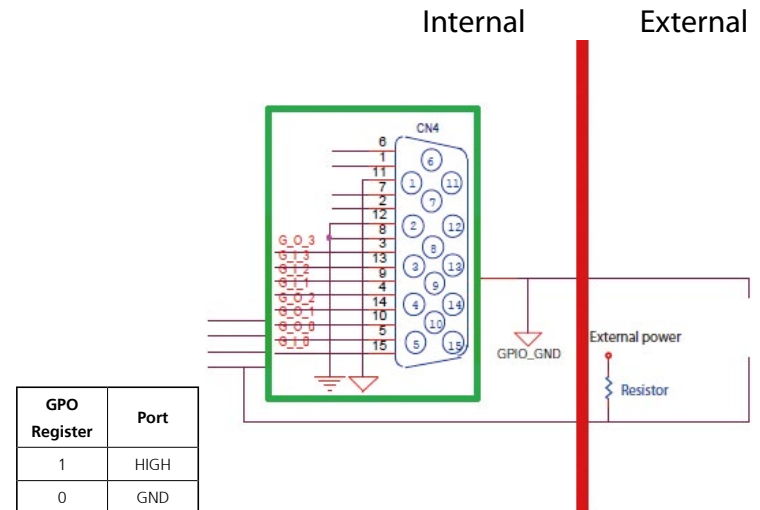

APPENDIX D: VEHICLE POWER MANAGEMENT SETUP

Startup and Shutdown Voltage Setting

Set the startup voltage to 11.5V or 23V and the shutdown voltage to 10.5V or 21V

If the input voltage is 12V: the startup voltage to 11.5V and the shutdown voltage to 10.5V.

If the input voltage is 24V: the startup voltage to 23V and the shutdown voltage to 21V.

Set the startup voltage to 12.0V or 24V and the shutdown voltage to 11.0V or 22V

If the input voltage is 12V: the startup voltage to 12V and the shutdown voltage to 11V.

If the input voltage is 24V: the startup voltage to 24V and the shutdown voltage to 22V.

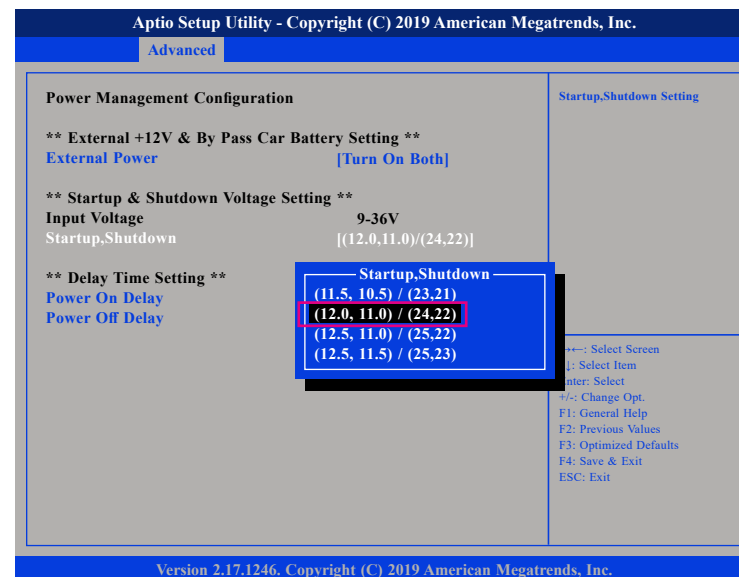
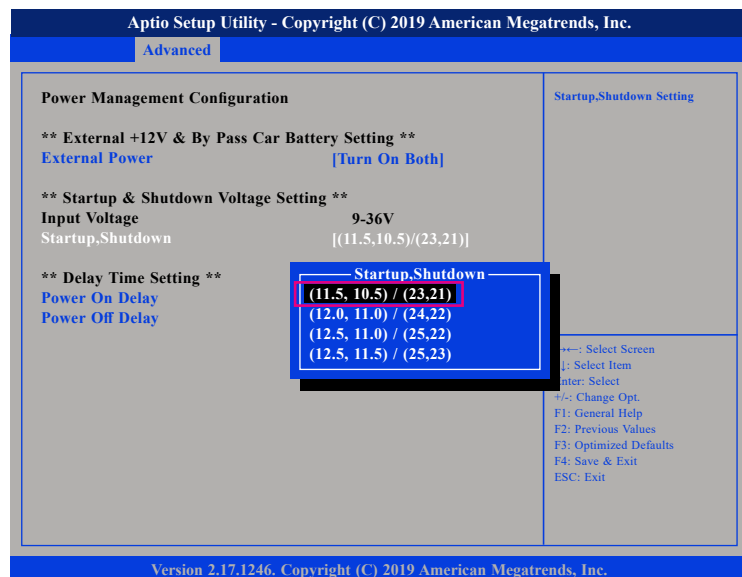

Set the startup voltage to 12.5V or 25V and the shutdown voltage to 11.0V or 22V

If the input voltage is 12V: the startup voltage to 12.5V and the shutdown voltage to 11V.

If the input voltage is 24V: the startup voltage to 25V and the shutdown voltage to 22V.

Set the startup voltage to 12.5V or 25V and the shutdown voltage to 11.0V or 22V

If the input voltage is 12V: the startup voltage to 12.5V and the shutdown voltage to 11.5V.

If the input voltage is 24V: the startup voltage to 25V and the shutdown voltage to 23V.

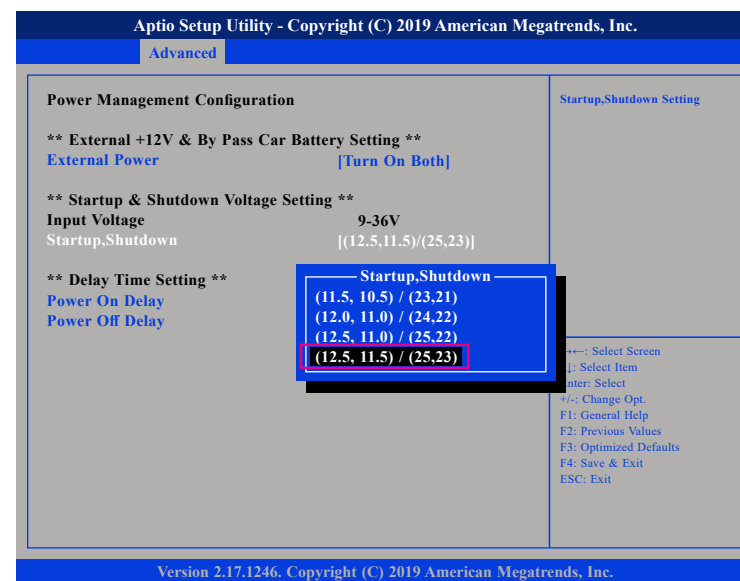
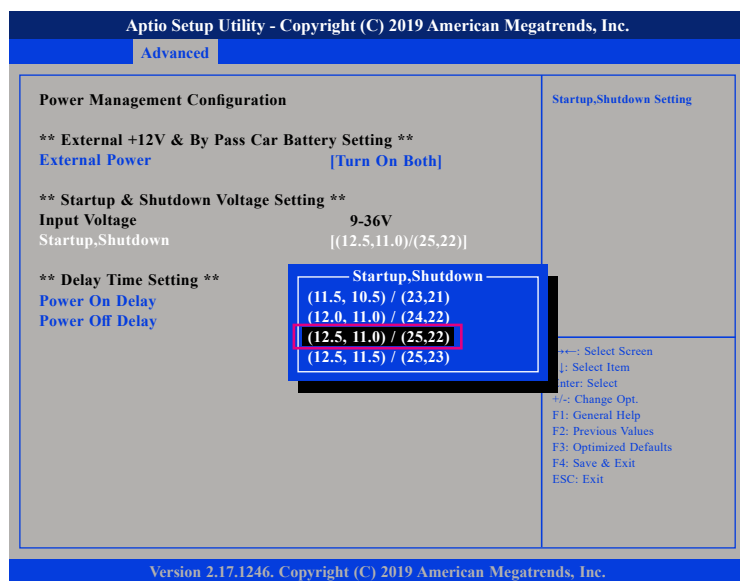

Power-on Delay Setting

Disable Power-on Delay

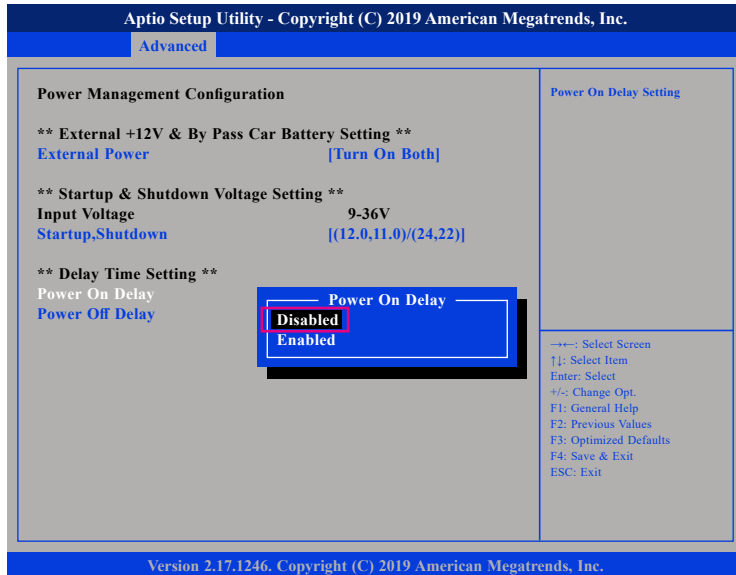

Enable Power-on Delay

Delay time can be set at 10sec/30sec/1min./5min./10min./15min./30min./1hour.

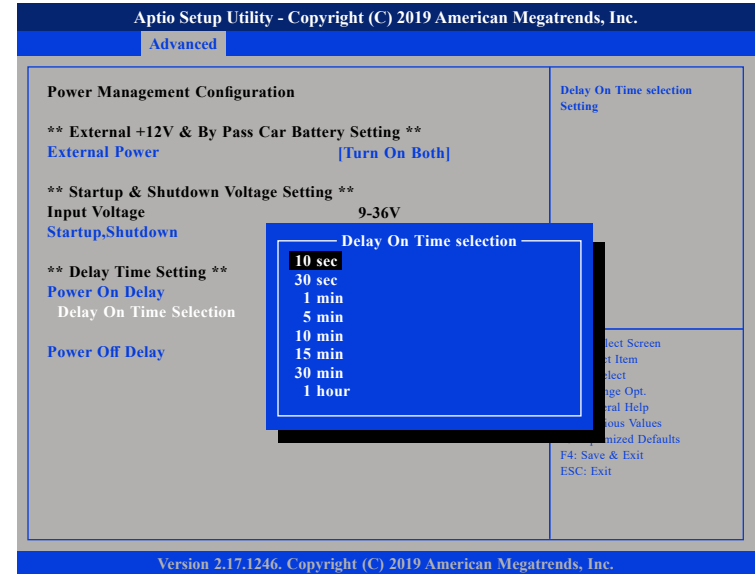
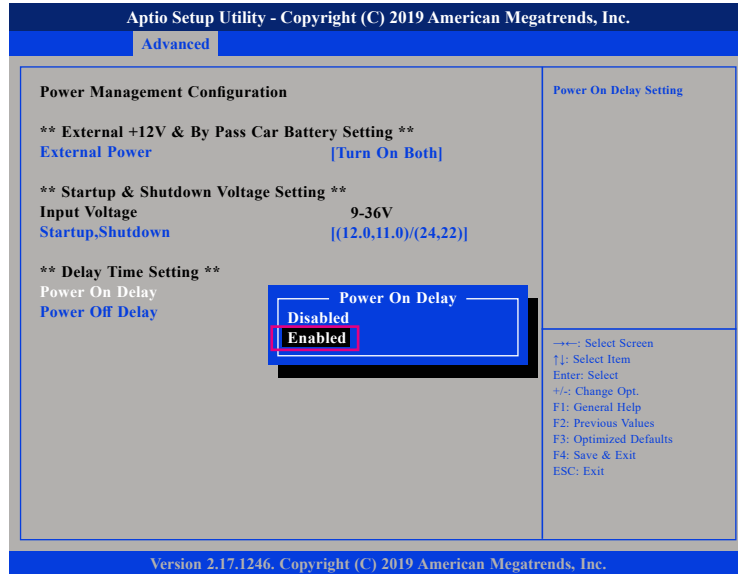

Power-off Delay Setting

Disable Power-off Delay

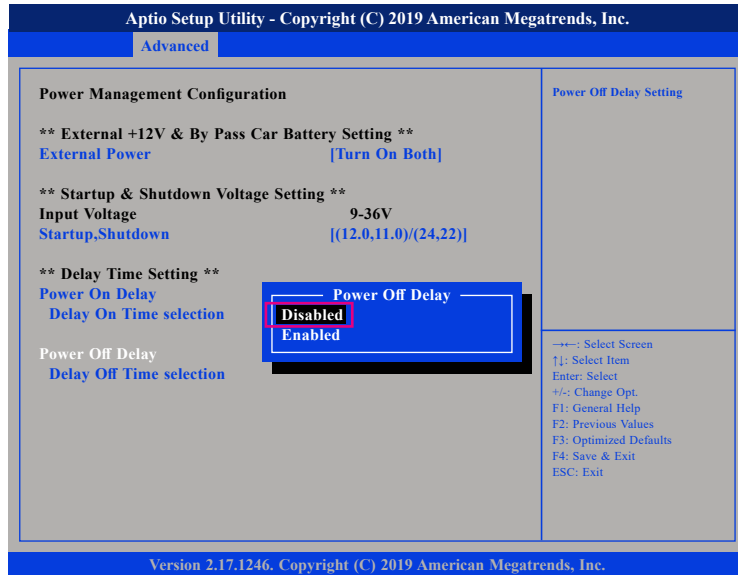

Enable Power-off Delay

Delay time can be set at 20sec/1min./5min./10min./30min./1hour/6hour/18hour.

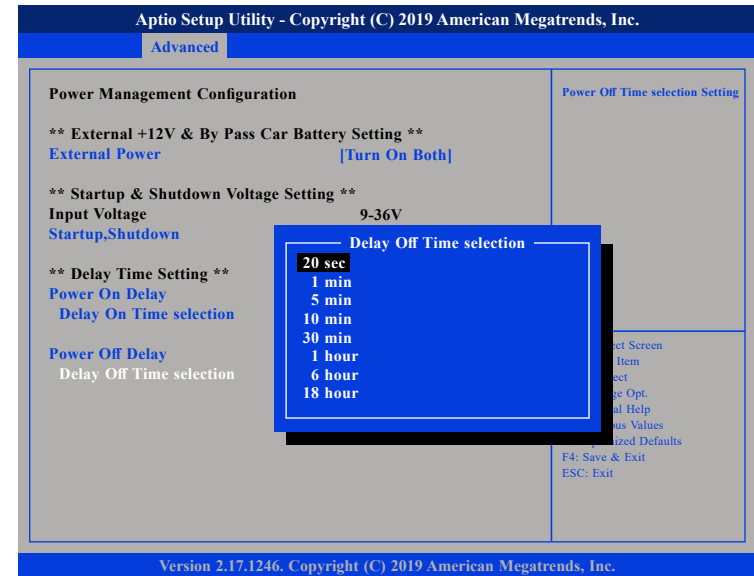
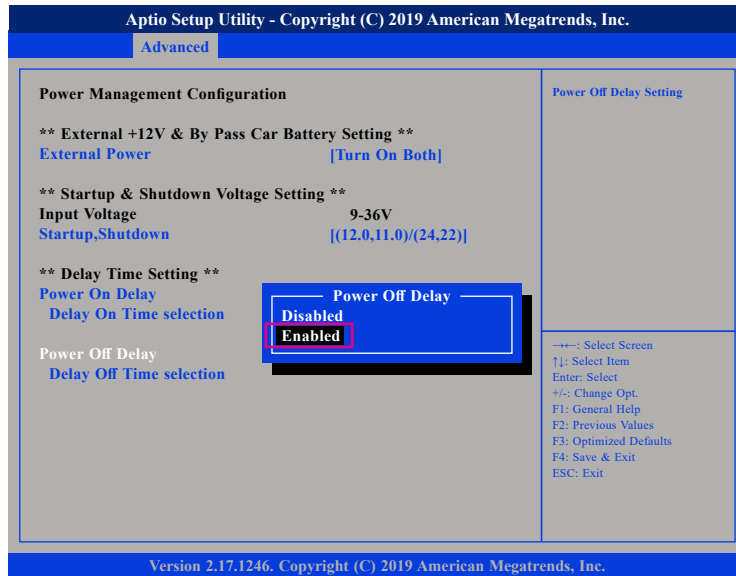

APPENDIX E: POWER CONSUMPTION

OS: Windows 10

Burn-in Software

Device:

Idle: Into OS + Display x3 (HDMI + VGA + ultraONE) + All module (unlink) + keyboard & mouse + speaker

Full State: Into OS + Display x3 (HDMI + VGA + ultraONE) + Burn In 100% + module (link) + play video + keyboard & mouse + speaker + COM transmit + GPS link

Full State + Loading: Full state + USB Load (5V/1A) x 4 + DC out (12V/2A) + COM PWR load (12V/1A) + POE (15W) x4

Item	Device	Test Case	Result		
			Current(A)	Watt(W)	
1	S0 State	Idle State	12V	4.27	51.24
			24V	2.27	54.48
			36V	1.65	59.4
		Full State	12V	8.29	99.48
			24V	4.31	103.44
			36V	3.22	115.92
		Full State + Loading	12V	14.3	171.6
			24V	7.09	171.16
			36V	4.90	176.4
		Full State + Loading (PoE_60W)	12V	20.41	244.92
			24V	9.73	233.52
			36V	6.60	237.6
2	S3 State	Full State Sleep Mode	12V	0.9A	
3	IGN OFF	Full State IGNITION OFF	12V	10mA	
			24V	10mA	