



**NEXCOM International Co., Ltd.**

## **Mobile Computing Solutions**

# **Vehicle Telematics & Railway Computer**

## **VTC 6222 and nROK 6222**

### User Manual

# CONTENTS

## Preface

Copyright .....	v
Disclaimer .....	v
Acknowledgements .....	v
Regulatory Compliance Statements .....	v
Declaration of Conformity.....	v
RoHS Compliance .....	vi
Warranty and RMA .....	vii
Technical Support and Assistance.....	x
Conventions Used in this Manual.....	x
Global Service Contact Information.....	xi
VTC 6222 Package Contents.....	xiii
nROK 6222 Package Contents.....	xiv

## Chapter 1: Product Introduction

VTC 6222 Physical Features.....	1
Front View.....	1
Rear View.....	1
Overview .....	2
Key Features .....	2
VTC 6222 Hardware Specifications.....	3
nROK 6222 Physical Features .....	5
Front View.....	5
Rear View.....	5
Overview .....	6

Key Features .....	6
nROK 6222 Hardware Specifications .....	7
Connector Numbering .....	9
nROK 6222 Front View.....	9
VTC 6222 Front View .....	9
nROK 6222 Rear View.....	10
VTC 6222 Rear View .....	10

## Chapter 2: External Connectors Pinout Description

Power Button .....	11
Reset.....	11
SATA/LAN LED Indicators .....	12
WWAN/WLAN LED Indicators .....	12
PoE LAN LED Indicators .....	13
STATUS LED Indicators (User Programmable).....	13
HDMI Connector .....	14
USB 3.0 Port.....	14
HDMI Connector .....	15
SIM1 to SIM2 Mini-SIM Sockets.....	15
SD Card Slot.....	16
M12 Audio Connector (nROK 6222).....	16
Mic-in Connector .....	17
Line-out2 Connector .....	17
M12 USB 2.0 Connector (nROK 6222).....	18
M12 LAN Connector (nROK 6222).....	18
M12 PoE LAN Connectors (nROK 6222).....	19

COM Port.....	19
Multi Port.....	20
VGA.....	20
DIO.....	21
DC Input (nROK 6222).....	21
Line-out1 Connector (VTC 6222).....	22
USB 2.0 Ports (VTC 6222).....	22
LAN Port (VTC 6222).....	23
PoE LAN Ports (VTC 6222).....	23
DC Input 9V-48V (VTC 6222).....	24

## Chapter 3: Jumpers and Connectors

Before You Begin .....	25
Precautions .....	25
Jumper Settings.....	26
VTC 6222 and nROK 6222 Connector Specification & Jumper Setting ..	27
Jumper and DIP Switch Settings .....	28
GPO Pull High Selection.....	28
GPI Pull High Selection .....	28
Input Voltage Selection Switch.....	29
RS422/RS485 Terminator Resistor Selection Switch .....	29
CAN Terminator Resistor Selection Switch.....	30
RTC Clear CMOS .....	30
Connectors.....	31
GPS Module RF Connector .....	31
Internal Audio Header (Line-out and Mic-in) .....	31
USB 2.0 DOM .....	32
SATA Connectors.....	32
SATA Power Connectors .....	33
GPS Battery Connector .....	33
RTC Battery Connector.....	34
PoE Power Connector.....	34

RS232/RS422/RS485/CAN Connector .....	35
GPIO Connector .....	35
DC 12V OUT Connector .....	36
Internal RS232 COM1 Connector .....	36
Internal VGA Connector .....	37
SIM1 to SIM2 Mini-SIM Slots .....	37
Full Size Mini-PCIe Socket (USB 2.0) for LTE Module with 2 x External SIM .....	38
Full Size Mini-PCIe Socket (USB 2.0, PCIe 2.0).....	39
Half Size Mini-PCIe Socket (USB 2.0, PCIe 2.0).....	40

## Chapter 4: System Setup

Removing the Chassis Cover .....	41
Installing a SSD/HDD Drive .....	42
Inserting SIM Cards.....	44
Inserting an SD Card.....	45
Installing a WLAN Module .....	46
Installing a WWAN Module.....	46
Installing a SO-DIMM Memory Module .....	47

## Appendix A: Software Demo Utility for I/O Ports of Function Control

Menu Screen .....	48
1. System 1 .....	48
2. System 2 .....	50
3. I/O .....	51
4. Module .....	53
5. G-Sensor .....	55
6. PoE.....	56
7. Event.....	57

## Appendix B: GPS Feature

uBlox-NEO M8 Overview.....	58
Technical Specifications.....	58

## Appendix C: Signal Connection of MCU DI/DO

GPIO Pinout Description.....	60
GPO Pull High Selection (JP5).....	60
GPI Pull High Selection (JP6).....	61
Digital Input.....	62
Digital Output.....	63

## Appendix D: Vehicle Power Management Setup

Startup and Shutdown Voltage Setting .....	64
Power-on Delay Setting.....	66
Power-off Delay Setting .....	68

## Appendix E: Pin Definition for the Multi Port Cable

P2 Connector Pinout.....	71
P1 and P3 Connector Pinouts.....	71
Green (Line-out) Connector .....	71
Pink (Mic-in) Connector.....	72
CN1 Connector Pinout.....	74
CN2 and CN3 Connector Pinouts.....	74
USB Connector.....	74
USB Connector.....	75
P1 Connector Pinout.....	77
P2 to P5 Connector Pinouts .....	77
CAN Connector.....	77
RS232 Connector .....	78
RS485/RS422 Connector .....	78
DC Output Connector .....	79
P1 Connector Pinout.....	81

## Appendix F: Power Consumption

# PREFACE

## Copyright

This publication, including all photographs, illustrations and software, is protected under international copyright laws, with all rights reserved. No part of this manual may be reproduced, copied, translated or transmitted in any form or by any means without the prior written consent from NEXCOM International Co., Ltd.

## Disclaimer

The information in this document is subject to change without prior notice and does not represent commitment from NEXCOM International Co., Ltd. However, users may update their knowledge of any product in use by constantly checking its manual posted on our website: <http://www.nexcom.com>. NEXCOM shall not be liable for direct, indirect, special, incidental, or consequential damages arising out of the use of any product, nor for any infringements upon the rights of third parties, which may result from such use. Any implied warranties of merchantability or fitness for any particular purpose is also disclaimed.

## Acknowledgements

VTC 6222 and nROK 6222 are trademarks of NEXCOM International Co., Ltd. All other product names mentioned herein are registered trademarks of their respective owners.

## Regulatory Compliance Statements

This section provides the FCC compliance statement for Class A devices and describes how to keep the system CE compliant.

## Declaration of Conformity

### FCC

This equipment has been tested and verified to comply with the limits for a Class A digital device, pursuant to Part 15 of FCC Rules. These limits are designed to provide reasonable protection against harmful interference when the equipment is operated in a commercial environment. This equipment generates, uses, and can radiate radio frequency energy and, if not installed and used in accordance with the instructions, may cause harmful interference to radio communications. Operation of this equipment in a residential area (domestic environment) is likely to cause harmful interference, in which case the user will be required to correct the interference (take adequate measures) at their own expense.

### CE

The product(s) described in this manual complies with all applicable European Union (CE) directives if it has a CE marking. For computer systems to remain CE compliant, only CE-compliant parts may be used. Maintaining CE compliance also requires proper cable and cabling techniques.

## RoHS Compliance



### **NEXCOM RoHS Environmental Policy and Status Update**

NEXCOM is a global citizen for building the digital infrastructure. We are committed to providing green products and services, which are compliant with European Union RoHS (Restriction on Use of Hazardous Substance in Electronic Equipment) directive 2011/65/EU, to be your trusted green partner and to protect our environment.

RoHS restricts the use of Lead (Pb) < 0.1% or 1,000ppm, Mercury (Hg) < 0.1% or 1,000ppm, Cadmium (Cd) < 0.01% or 100ppm, Hexavalent Chromium (Cr6+) < 0.1% or 1,000ppm, Polybrominated biphenyls (PBB) < 0.1% or 1,000ppm, and Polybrominated diphenyl Ethers (PBDE) < 0.1% or 1,000ppm.

In order to meet the RoHS compliant directives, NEXCOM has established an engineering and manufacturing task force in to implement the introduction of green products. The task force will ensure that we follow the standard NEXCOM development procedure and that all the new RoHS components and new manufacturing processes maintain the highest industry quality levels for which NEXCOM are renowned.

### **How to recognize NEXCOM RoHS Products?**

For existing products where there are non-RoHS and RoHS versions, the suffix "(LF)" will be added to the compliant product name.

All new product models launched after January 2013 will be RoHS compliant. They will use the usual NEXCOM naming convention.

## Warranty and RMA

### NEXCOM Warranty Period

NEXCOM manufactures products that are new or equivalent to new in accordance with industry standard. NEXCOM warrants that products will be free from defect in material and workmanship for 2 years, beginning on the date of invoice by NEXCOM.

### NEXCOM Return Merchandise Authorization (RMA)

- Customers shall enclose the “NEXCOM RMA Service Form” with the returned packages.
- Customers must collect all the information about the problems encountered and note anything abnormal or, print out any on-screen messages, and describe the problems on the “NEXCOM RMA Service Form” for the RMA number apply process.
- Customers can send back the faulty products with or without accessories (manuals, cable, etc.) and any components from the card, such as CPU and RAM. If the components were suspected as part of the problems, please note clearly which components are included. Otherwise, NEXCOM is not responsible for the devices/parts.
- Customers are responsible for the safe packaging of defective products, making sure it is durable enough to be resistant against further damage and deterioration during transportation. In case of damages occurred during transportation, the repair is treated as “Out of Warranty.”
- Any products returned by NEXCOM to other locations besides the customers’ site will bear an extra charge and will be billed to the customer.

### Repair Service Charges for Out-of-Warranty Products

NEXCOM will charge for out-of-warranty products in two categories, one is basic diagnostic fee and another is component (product) fee.

#### System Level

- Component fee: NEXCOM will only charge for main components such as SMD chip, BGA chip, etc. Passive components will be repaired for free, ex: resistor, capacitor.
- Items will be replaced with NEXCOM products if the original one cannot be repaired. Ex: motherboard, power supply, etc.
- Replace with 3rd party products if needed.
- If RMA goods can not be repaired, NEXCOM will return it to the customer without any charge.

#### Board Level

- Component fee: NEXCOM will only charge for main components, such as SMD chip, BGA chip, etc. Passive components will be repaired for free, ex: resistors, capacitors.
- If RMA goods can not be repaired, NEXCOM will return it to the customer without any charge.

## Warnings

Read and adhere to all warnings, cautions, and notices in this guide and the documentation supplied with the chassis, power supply, and accessory modules. If the instructions for the chassis and power supply are inconsistent with these instructions or the instructions for accessory modules, contact the supplier to find out how you can ensure that your computer meets safety and regulatory requirements.

## Cautions

Electrostatic discharge (ESD) can damage system components. Do the described procedures only at an ESD workstation. If no such station is available, you can provide some ESD protection by wearing an antistatic wrist strap and attaching it to a metal part of the computer chassis.

## Safety Information

Before installing and using the device, note the following precautions:

- Read all instructions carefully.
- Do not place the unit on an unstable surface, cart, or stand.
- Follow all warnings and cautions in this manual.
- When replacing parts, ensure that your service technician uses parts specified by the manufacturer.
- Avoid using the system near water, in direct sunlight, or near a heating device.
- The load of the system unit does not solely rely for support from the rackmounts located on the sides. Firm support from the bottom is highly necessary in order to provide balance stability.
- The computer is provided with a battery-powered real-time clock circuit. There is a danger of explosion if battery is incorrectly replaced. Replace only with the same or equivalent type recommended by the manufacturer. Discard used batteries according to the manufacturer's instructions.

## Installation Recommendations

Ensure you have a stable, clean working environment. Dust and dirt can get into components and cause a malfunction. Use containers to keep small components separated.

Adequate lighting and proper tools can prevent you from accidentally damaging the internal components. Most of the procedures that follow require only a few simple tools, including the following:

- A Philips screwdriver
- A flat-tipped screwdriver
- A grounding strap
- An anti-static pad

Using your fingers can disconnect most of the connections. It is recommended that you do not use needlenose pliers to disconnect connections as these can damage the soft metal or plastic parts of the connectors.

### Warning!

1. Handling the unit: carry the unit with both hands and handle it with care.
2. Maintenance: to keep the unit clean, use only approved cleaning products or clean with a dry cloth.
3. CompactFlash: Turn off the unit's power before inserting or removing a CompactFlash storage card.
4. SIM: Do not insert or remove the SIM card when the **system is powered** on. Always **power** off the **system** before inserting or removing the SIM card.



## Safety Precautions

- Read these safety instructions carefully.
- Keep this User Manual for later reference.
- Disconnect this equipment from any AC outlet before cleaning. Use a damp cloth. Do not use liquid or spray detergents for cleaning.
- For plug-in equipment, the power outlet socket must be located near the equipment and must be easily accessible.
- Keep this equipment away from humidity.
- Put this equipment on a stable surface during installation. Dropping it or letting it fall may cause damage.
- Do not leave this equipment in either an unconditioned environment or in a above 40°C storage temperature as this may damage the equipment.
- The openings on the enclosure are for air convection to protect the equipment from overheating. DO NOT COVER THE OPENINGS.
- Make sure the voltage of the power source is correct before connecting the equipment to the power outlet.
- Place the power cord in a way so that people will not step on it. Do not place anything on top of the power cord. Use a power cord that has been approved for use with the product and that it matches the voltage and current marked on the product's electrical range label. The voltage and current rating of the cord must be greater than the voltage and current rating marked on the product.
- All cautions and warnings on the equipment should be noted.
- If the equipment is not used for a long time, disconnect it from the power source to avoid damage by transient overvoltage.
- Never pour any liquid into an opening. This may cause fire or electrical shock.
- Never open the equipment. For safety reasons, the equipment should be opened only by qualified service personnel.
- If one of the following situations arises, get the equipment checked by service personnel:
  - a. The power cord or plug is damaged.
  - b. Liquid has penetrated into the equipment.
  - c. The equipment has been exposed to moisture.
  - d. The equipment does not work well, or you cannot get it to work according to the user's manual.
  - e. The equipment has been dropped and damaged.
  - f. The equipment has obvious signs of breakage.
- Do not place heavy objects on the equipment.
- The unit uses a three-wire ground cable which is equipped with a third pin to ground the unit and prevent electric shock. Do not defeat the purpose of this pin. If your outlet does not support this kind of plug, contact your electrician to replace your obsolete outlet.
- CAUTION: DANGER OF EXPLOSION IF BATTERY IS INCORRECTLY REPLACED. REPLACE ONLY WITH THE SAME OR EQUIVALENT TYPE RECOMMENDED BY THE MANUFACTURER. DISCARD USED BATTERIES ACCORDING TO THE MANUFACTURER'S INSTRUCTIONS.
- The computer is provided with CD drives that comply with the appropriate safety standards including IEC 60825.

## Technical Support and Assistance

1. For the most updated information of NEXCOM products, visit NEXCOM's website at [www.nexcom.com](http://www.nexcom.com).
2. For technical issues that require contacting our technical support team or sales representative, please have the following information ready before calling:
  - Product name and serial number
  - Detailed information of the peripheral devices
  - Detailed information of the installed software (operating system, version, application software, etc.)
  - A complete description of the problem
  - The exact wordings of the error messages

### Warning!

1. Handling the unit: carry the unit with both hands and handle it with care.
2. Maintenance: to keep the unit clean, use only approved cleaning products or clean with a dry cloth.

## Conventions Used in this Manual



### Warning:

Information about certain situations, which if not observed, can cause personal injury. This will prevent injury to yourself when performing a task.



### Caution:

Information to avoid damaging components or losing data.



### Note:

Provides additional information to complete a task easily.

## Global Service Contact Information

### Headquarters

#### **NEXCOM International Co., Ltd.**

9F, No. 920, Zhongzheng Rd.,  
Zhonghe District, New Taipei City, 23586,  
Taiwan, R.O.C.  
Tel: +886-2-8226-7786  
Fax: +886-2-8226-7782  
www.nexcom.com

### Asia

#### **Taiwan**

#### **NexAIoT Headquarters**

#### **Industry 4.0 and Cloud Services**

13F, No.922, Zhongzheng Rd.,  
Zhonghe District, New Taipei City,  
23586, Taiwan, R.O.C.  
Tel: +886-2-8226-7796  
Fax: +886-2-8226-7926  
Email: jacobhuang@nexaiot.com  
www.nexaiot.com

#### **NexAIoT Co., Ltd.**

#### **Taichung Office**

16F, No.250, Sec.2, Chongde Rd.,  
Beitun District,  
Taichung City, 406, Taiwan, R.O.C.  
Tel: +886-4-2249-1179  
Fax: +886-4-2249-1172  
Email: jacobhuang@nexaiot.com  
www.nexaiot.com

#### **NexCOBOT Taiwan Co., Ltd.**

13F, No.916, Zhongzheng Rd.,  
Zhonghe District,  
New Taipei City, 23586, Taiwan, R.O.C.  
Tel: +886-2-8226-7786  
Fax: +886-2-8226-7926  
Email: jennyshern@nexcobot.com  
www.nexcobot.com

#### **GreenBase Technology Corp.**

13F, No.922, Zhongzheng Rd.,  
Zhonghe District,  
New Taipei City, 23586, Taiwan, R.O.C.  
Tel: +886-2-8226-7786  
Fax: +886-2-8226-7900  
Email: vivianlin@nexcom.com.tw  
www.nexcom.com.tw

#### **DivioTec Inc.**

19F-1A, No.97, Sec.4, ChongXin Rd.,  
Sanhong District,  
New Taipei City, 24161, Taiwan, R.O.C.  
Tel: +886-2-8976-3077  
Email: sales@diviotec.com  
www.diviotec.com

#### **AIoT Cloud Corp.**

13F, No.922, Zhongzheng Rd.,  
Zhonghe District,  
New Taipei City, 23586, Taiwan, R.O.C.  
Tel: +886-2-8226-7786  
Fax: +886-2-8226-7782  
Email: alantsai@aiotcloud.net  
www.aiotcloud.dev

#### **EMBUX TECHNOLOGY CO., LTD.**

13F, No.916, Zhongzheng Rd.,  
Zhonghe District,  
New Taipei City, 23586, Taiwan, R.O.C.  
Tel: +886-2-8226-7786  
Fax: +886-2-8226-7782  
Email: info@embux.com  
www.embux.com

#### **TMR TECHNOLOGIES CO., LTD.**

13F, No.916, Zhongzheng Rd.,  
Zhonghe District,  
New Taipei City, 23586, Taiwan, R.O.C.  
Tel: +886-2-8226-7786  
Fax: +886-2-8226-7782  
Email: services@tmrtek.com  
www.tmrtek.com

## China NEXSEC Incorporated

201, Floor 2, Unit 2, Building 15, Yard 3,  
Gaolizhang Road, Haidian District,  
Beijing, 100094, China  
Tel: +86-10-5704-2680  
Fax: +86-10-5704-2681  
Email: marketing@nexsec.cn  
www.nexsec.cn

## NEXCOM Shanghai

Room 406-407, Building C, No 154, Lane 953,  
Jianchuan Road, Minhang District,  
Shanghai, 201108, China  
Tel: +86-21-5278-5868  
Fax: +86-21-3251-6358  
Email: sales@nexcom.cn  
www.nexcom.cn

## NEXCOM Surveillance Technology Corp.

Floor 8, Building B3, Xiufeng Industrial Zone,  
GanKeng Community, Buji Street,  
LongGang District,  
ShenZhen, 518112, China  
Tel: +86-755-8364-7768  
Fax: +86-755-8364-7738  
Email: steveyang@nexcom.com.tw  
www.nexcom.cn

## NEXGOL Chongqing

1st Building No.999,  
Star Boulevard, Yongchuan Dist,  
Chongqing City, 402160, China  
Tel: +86-23-4960-9080  
Fax: +86-23-4966-5855  
Email: sales@nexgol.com.cn  
www.nexcom.cn

## Beijing NexGemo Technology Co.,Ltd.

Room 205, No.1, Fazhan Rd.,  
Beijing International Information Industry Base,  
Changping District,  
Beijing, 102206, China  
Tel: +86-10-8072-2025  
Fax: +86-10-8072-2022  
Email: sales@nexgemo.cn  
www.nexgemo.com

## Japan

### NEXCOM Japan

9F, Tamachi Hara Bldg.,  
4-11-5, Shiba Minato-ku,  
Tokyo, 108-0014, Japan  
Tel: +81-3-5419-7830  
Fax: +81-3-5419-7832  
Email: sales@nexcom-jp.com  
www.nexcom-jp.com

## America

### USA NEXCOM USA

46665 Fremont Blvd.,  
Fremont CA 94538, USA  
Tel: +1-510-656-2248  
Fax: +1-510-656-2158  
Email: sales@nexcom.com  
www.nexcomusa.com

## Europe

### United Kingdom NEXCOM EUROPE

10 Vincent Avenue,  
Crownhill Business Centre,  
Milton Keynes, Buckinghamshire  
MK8 0AB, United Kingdom  
Tel: +44-1908-267121  
Fax: +44-1908-262042  
Email: sales.uk@nexcom.eu  
www.nexcom.com

## VTC 6222 Package Contents

Before continuing, verify that the package that you received is complete. Your package should have all the items listed in the following table.

Item	P/N	Name	Specification	Qty
1	60110A0267X00	Inner Box for VTC 6222-C4S VER:A YI GIA	286x180x50mm B Flute	1
2	60111A0700X00	Inner Carton for VTC 6222-C4S VER:A YI GIA	365x300x230mm AB Flute	1
3	60111A0701X00	Outside Carton for VTC 6222-C4S VER:A YI GIA	379x315x251mm B Flute	1
4	6012200052X00	PE Zipper Bag #8	170x240mm, w/China RoHS Symbol	1
5	6012200053X00	PE Zipper Bag #3	100x70mm, w/China RoHS Symbol	1
6	6012200094X00	PE Bag for APPC 1230T VER:A Taiwan EPE	330x432x0.08mm	1
7	6013301296X00	EPE for VTC 6222-C4S VER:A Sentenel	355x210x104.5mm	1
8	50311F0581X00	I Head Bolts Screw Long Fei:I3x15.8 ISO NIGP	I3x5.8 Axis x2.8mm Screw x3mm	2
9	50333P0027X00	Washer for SMA CONN Kang Yang:TW-181	13x1.8mm Nylon 66 Natural	8
10	50333P0028X00	Washer for SMA CONN Kang Yang:WS6-0.8(B)	12.8x6.4x0.8mm PC Black	4
11	5061000004X00	Damper Anti-vibrate Grommet Kang Yang:TGM-50G(B)	D7xH2.8mm TPE Color:Black	4
12	4NCPM00302X00	Terminal Blocks 3P Phoenix Contact:1777992	5.08mm Male DIP Green	8
13	602DCD1643X00	VTC 6222-C4S DVD Driver VER:1.0	JCL	1
14	603ANT0115X00	GPS/Glonass Antenna SANAV:SM-76G	SMA Male L=5000mm	1

## nROK 6222 Package Contents

Before continuing, verify that the package that you received is complete. Your package should have all the items listed in the following table.

Item	P/N	Name	Specification	Qty
1	60110A0267X00	Inner Box for VTC 6222-C4S VER:A YI GIA	286x180x50mm B Flute	1
2	60111A0700X00	Inner Carton for VTC 6222-C4S VER:A YI GIA	365x300x230mm AB Flute	1
3	60111A0701X00	Outside Carton for VTC 6222-C4S VER:A YI GIA	379x315x251mm B Flute	1
4	6012200052X00	PE Zipper Bag #8	170x240mm, w/China RoHS Symbol	1
5	6012200053X00	PE Zipper Bag #3	100x70mm, w/China RoHS Symbol	1
6	6012200094X00	PE Bag for APPC 1230T VER:A Taiwan EPE	330x432x0.08mm	1
7	6013301296X00	EPE for VTC 6222-C4S VER:A Sentenel	355x210x104.5mm	1
8	50311F0581X00	I Head Bolts Screw Long Fei:13x15.8 ISO NIGP	13x5.8 Axis x2.8mm Screw x3mm	2
9	50333P0027X00	Washer for SMA CONN Kang Yang:TW-181	13x1.8mm Nylon 66 Natural	8
10	50333P0028X00	Washer for SMA CONN Kang Yang:WS6-0.8(B)	12.8x6.4x0.8mm PC Black	4
11	5061000004X00	Damper Anti-Vibrate Grommet Kang Yang:TGM-50G(B)	D7xH2.8mm TPE Color:Black	4
12	603POW0378X00	Power Cable ST:MD-5108077	Waterproof M12 A Coded 5-pin (female) to Open L=300mm	8
13	602DCD1643X00	VTC 6222-C4S DVD Driver VER:1.0	JCL	1
14	603ANT0115X00	GPS/Glonass Antenna SANAV:SM-76G	SMA Male L=5000mm	1

## Ordering Information

The following provides ordering information for VTC 6222 and nROK 6222.

- **VTC 6222-C4S (P/N: 10V00622200X0)**

Intel Atom® processor E3950 up to 2.0GHz CPU, 4GB DDR3L SO-DIMM, DC input 9~48 VDC, 1 x VGA, 2 x HDMI, 1 x LAN, 4 x PoE, 2 x RS-232, 1 x RS-422/485, 8 x GPIO, 1 x USB 3.0, 2 x USB 2.0

- **nROK 6222-AC4S (P/N: 10A00622200X0)**

Intel Atom® processor E3950 up to 2.0GHz CPU, 4GB DDR3L SO-DIMM, DC input 24/36 VDC w/o isolation, 1 x VGA, 2 x HDMI, 1 x LAN, 4 x PoE, 2 x RS-232, 1 x RS-422/485, 8 x GPIO, 1 x USB 3.0, 2 x USB 2.0

- **VTK6222-APK (P/N: 10VK0622200X0)**

Attachable power kit for power isolation, DC input 24VDC

- **VTK6222-FPK (P/N: 10VK0622201X0)**

Attachable power kit for power isolation, DC input 110VDC

# CHAPTER 1: PRODUCT INTRODUCTION

## VTC 6222 Physical Features

### Front View

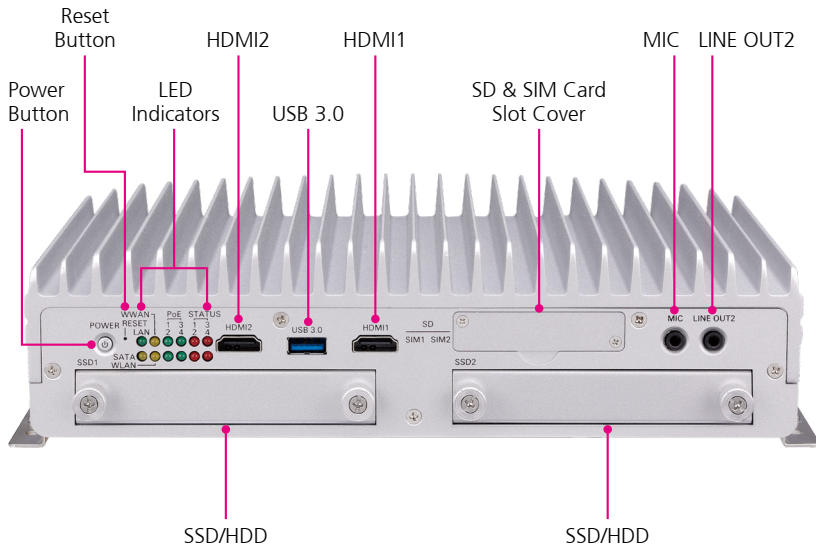

### Rear View

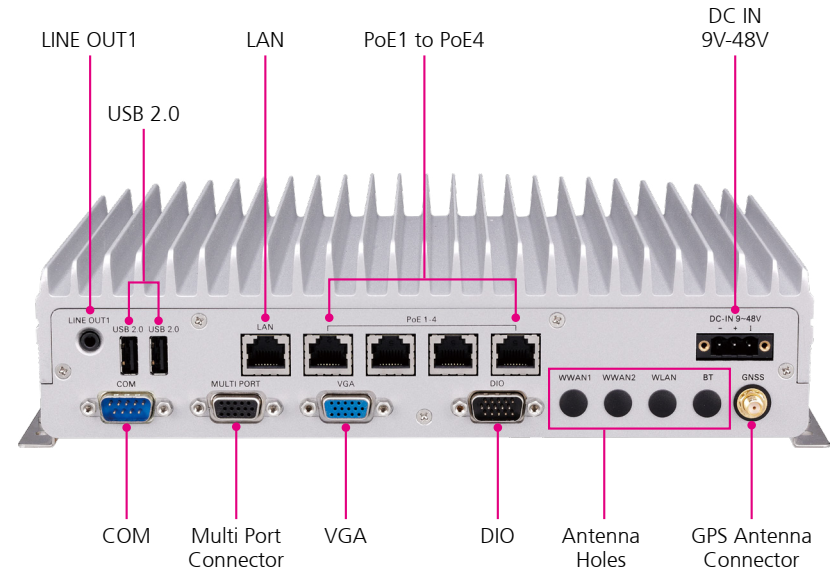



## Overview

VTC 6222, based on Intel Atom® quad core processor E3950 (up to 2.0GHz), is specifically comply with stringent E mark standard in rugged, fanless and compact mechanism. VTC 6222 provides complete communication capability between vehicle and computer with built-in CAN BUS 2.0B interface. Equipped with intelligent power management, VTC 6222 can be waked on by ignition, RTC timer or SMS message remotely. VTC 6222 supports 4 x 802.3at/3af (max. 60W) PoE ports to connect with IP cameras. The design of 2.5" removable SSD and SD memory card helps to access storage easily. VTC 6222 keeps the flexibility to meet the demand for video surveillance in vehicle application.

## Key Features

- Intel Atom® processor quad core E3950, up to 2.0GHz
- 4 x PoE (802.3af/at, max. 60W)
- Built-in u-blox-M8N GPS
- Built-in CAN Bus 2.0B
- Three video outputs, one VGA and two HDMI
- E Mark conformity
- 3 x mini-PCIe socket expansion
- Dual external storage (compatible with 15mm disk)
- 1 x USB DOM to run OS
- 1 x SD card for exporting and backing up data

## VTC 6222 Hardware Specifications

### CPU

- Intel Atom® processor quad core E3950, up to 2.0GHz, 12W, 4 core

### Memory

- 1 x 204-pin DDR3L SO-DIMM socket support 1866MHz up to 8GB, default 4GB

### Video Output

- Chipset Intel® HD Graphics 505
- 2 x HDMI 1.4b up to 4096 x 2160 @30Hz
- 1 x VGA up to 1920 x 1200 @60Hz

### Storage

- 2 x 2.5" SSD/HDD SATA 3.0 (compatible with 15mm drive)
- 1 x SD memory card 3.0 (externally accessible)
- 1 x USB EDC for USB DOM

### Expansion

- 1 x Full size mini-PCIe socket (USB 2.0) for LTE module, BOM optional
- M.2 3042 Key B (USB 2.0, USB 3.0) for LTE/5G NR module with 2 x external SIM
- 1 x Full size mini-PCIe socket (USB 2.0, PCIe 2.0)
- 1 x Half size mini-PCIe socket (USB 2.0, PCIe 2.0)

### GNSS and Onboard Sensor

- 1 x Default U-blox NEO-M8N GNSS for GPS/Glonass/QZSS/Galileo/Beidou
- G Sensor (3-axis, 10-bit resolution)

### LAN and Power over Ethernet

- 4-Port LAN, 10/100/1000 Mbps I210-IT GbE, PoE 802.3af/at, max. 60W
- 1-Port LAN, 10/100/1000 Mbps I210-IT GbE

### Security

- TPM 2.0: Infineon SLB9665TT2.0FW5.62 (BOM optional)

### I/O Interface-Front

- 12 x LED indicators (including 3 x programmable LEDs)
- 2 x Externally accessible SIM card sockets with cover
- 2 x 2.5" removable SSD trays
- 1 x Externally accessible SD card socket with cover
- 1 x Reset button
- 1 x Power button
- 1 x USB 3.0 type A (5V/0.9A)
- 2 x HDMI 1.4b
- 1 x Mic-in, 1 x line-out

### I/O Interface-Rear

- 1 x 3-pin terminal block for 9V~48V DC
- 1 x RJ45 10/100/1000 Mbps
- 4 x PoE 802.3af/at (max. 60W)
- 1 x VGA
- 1 x DB9 full RS-232
- 4 x SMA antenna
- 2 x USB 2.0 type A (5V/0.5A)
- 1 x Line-out
- 1 x DB15 (DIO)

- 4 x DI with isolation
- 4 x DO with isolation
- Vin, GND for GPIO
- 1 x DB15 (Multi Port)
  - 1 x RS422/RS485
  - 1 x RS232 (TX/RX)
  - 1 x CAN 2.0B
  - 1 x 12VDC, 2A output (Vout, GND)

### Power Management

- Power input 9~48 VDC
- Selectable boot-up & shut-down voltage for low power protection by software
- Setting 8-level power on/off delay time by software
- Support S3/S4 suspend mode
- 10~255 seconds WDT support, setup by software
- SDK (Windows/Linux) including utility and sample code

### Operating System

- Windows 10/Linux

### Dimensions

- 260mm (W) x 196mm (D) x 66.5mm (H)

### Weight

- 3.2kg

### Environment

- Operating temperatures:
  - -40°C to 70°C (w/ industrial SSD) with air flow
- Storage temperatures: -40°C to 80°C
- Relative humidity: 10% to 90% (non-condensing)
- Vibration (SSD)
  - Operating: MIL-STD-810G, Method 514.6, Category 4, common carrier US highway truck vibration exposure
  - Storage: MIL-STD-810G, Method 514.6, Category 24, minimum integrity test
- Shock (SSD)
  - Operating: MIL-STD-810G, Method 516.6, Procedure I, functional shock=40g
  - Non-operating: MIL-STD-810G, Method 516.6, Procedure V, crash hazard shock test=75g

### Standards/Certifications

- CE
- FCC Class A
- E13 mark

# nROK 6222 Physical Features

## Front View

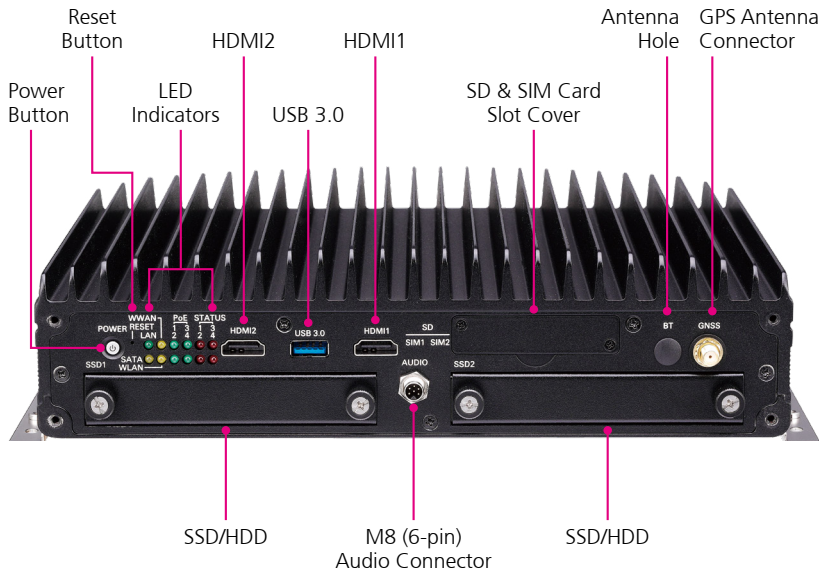

## Rear View

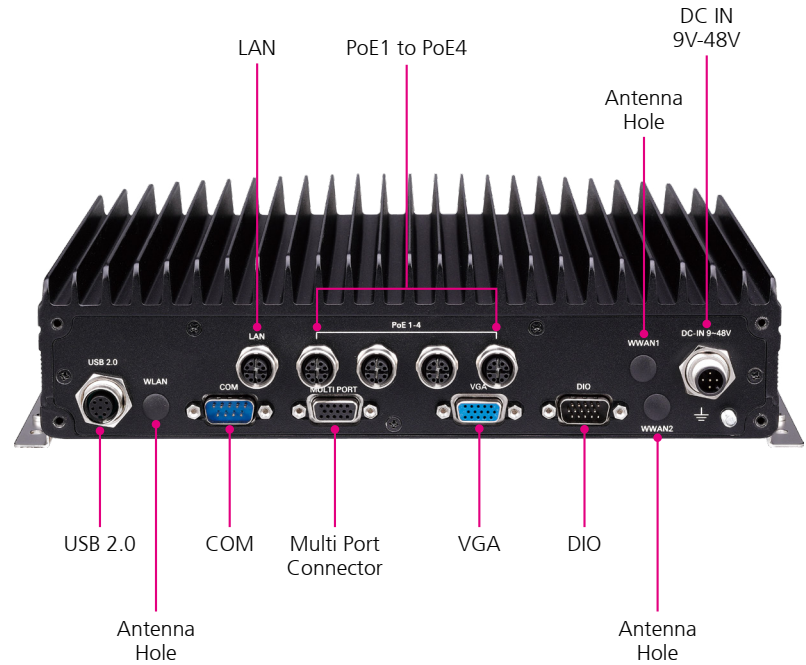

## Overview

nROK 6222, based on Intel Atom® quad core processor E3950 (up to 2.0GHz), is specifically comply with stringent EN50155 standard in rugged, fanless and compact mechanism. nROK 6222 provides complete communication capability between train and computer with built-in CAN BUS 2.0B interface. Equipped with intelligent power management, nROK 6222 can be waked on by ignition, RTC timer or SMS message remotely. nROK 6222 supports 4 x 802.3at/3af (Max. 60W) PoE ports to connect with IP cameras. The design of 2.5" removable SSD and SD memory card helps to access storage easily. nROK 6222 keeps the flexibility to meet the demand for video surveillance in train application. Moreover, nROK 6222 is protected against sudden power surges through an attachable VTK6222-PK power isolation kit.

## Key Features

- Intel Atom® processor quad core E3950, up to 2.0GHz
- 4 x PoE (802.3af/at, max. 60W)
- Built-in u-blox-M8N GPS
- Three video outputs, one VGA and two HDMI
- EN50155 conformity
- 3 x mini-PCIe socket expansion
- Dual external storage (compatible with 15mm disk)
- 1 x USB DOM to run OS
- 1 x SD card for exporting and backing up data
- Optional power isolation kit support

## nROK 6222 Hardware Specifications

### CPU

- Intel Atom® E3950 processor, quad core, up to 2.0GHz, 12W, 4 core

### Memory

- 1 x 204-pin DDR3L SO-DIMM socket support 1866MHz up to 8GB, default 4GB

### Video Output

- Chipset Intel® HD Graphics 505
- 2 x HDMI 1.4b up to 4096 x 2160 @30Hz
- 1 x VGA up to 1920 x 1200 @60Hz

### Storage

- 2 x 2.5" SSD/HDD SATA 3.0 (compatible with 15mm drive)
- 1 x SD memory card 3.0 (externally accessible)
- 1 x USB EDC for USB DOM

### Expansion

- 1 x Full size mini-PCIe socket (USB 2.0) for LTE module, BOM optional
- M.2 3042 Key B socket (USB 2.0, USB 3.0) for LTE/5G NR module with 2 x external SIM
- 1 x Full size mini-PCIe socket (USB 2.0, PCIe 2.0)
- 1 x Half size mini-PCIe socket (USB 2.0, PCIe 2.0)

### GNSS and Onboard Sensor

- 1 x Default U-blox NEO-M8N GNSS for GPS/Glonass/QZSS/Galileo/Beidou
- G Sensor (3-axis, 10-bit resolution)

### LAN and Power over Ethernet

- 4-Port LAN, 10/100/1000 Mbps I210-IT GbE, PoE 802.3af/at, max. 60W
- 1-Port LAN, 10/100/1000 Mbps I210-IT GbE

### Security

- TPM 2.0: Infineon SLB9665TT2.0FW5.62 (BOM optional)

### I/O Interface-Front

- 12 x LED indicators (including 3 x programmable LEDs)
- 2 x Externally accessible SIM card sockets with cover
- 2 x 2.5" removable SSD trays
- 1 x Externally accessible SD card socket with cover
- 1 x Reset button
- 1 x Power button
- 1 x USB 3.0 type A (5V/0.9A)
- 2 x HDMI 1.4b
- 1 x M8 (6-pin) for 1 x Mic-in (mono) and 1 x Line-out (stereo)
- 2 x SMA antennas

### I/O Interface-Rear

- 1 x M12 (5-pin) DC input with ignition
  - 24 / 36 VDC (9~48V), non-isolation
- 1 x M12 X-coded LAN port, 10/100/1000 Mbps
- 4 x M12 X-coded PoE 802.3af/at (max. 60W)
- 1 x VGA
- 1 x M12 with two USB 2.0
- 1 x DB9 full RS-232 (isolation)
- 3 x SMA antennas

- 1 x DB15 (DIO)
  - 4 x DI with isolation
  - 4 x DO with isolation
  - Vin, GND for GPIO
- 1 x DB15 (Multi Port)
  - 1 x RS422/RS485
  - 1 x RS232 (TX/RX)
  - 1 x CAN 2.0B

### Power Management & Software Support

- Power input 24/36 VDC w/o isolation
- Selectable boot-up & shut-down voltage for low power protection by software
- Setting 8-level power on/off delay time by software
- Support S3/S4 suspend mode
- 10~255 seconds WDT support, setup by software
- SDK (Windows/Linux) including utility and sample code

### Operating System

- Windows 10/Linux

### Dimensions

- 260mm (W) x 196mm (D) x 66.5mm (H)

### Weight

- 3.4kg

### Environment

- Operating temperatures: EN 50155, class OT4 (-40~70°C), 85°C for 10 minutes (w/ industrial SSD) with air flow
- Storage temperatures: -40°C to 80°C
- Relative humidity: 10% to 90% (non-condensing)
- Vibration (SSD)
  - Operating: MIL-STD-810G, Method 514.6, Category 4, common carrier US highway truck vibration exposure
  - Storage: MIL-STD-810G, Method 514.6, Category 24, minimum integrity test
- Shock (SSD)
  - Operating: MIL-STD-810G, Method 516.6, Procedure I, functional shock=40g
  - Non-operating: MIL-STD-810G, Method 516.6, Procedure V, crash hazard shock test=75g

### Standards/Certifications

- CE
- FCC Class A
- EN 50155: 2017
  - Ambient temperature EN 50155, Class OT4 (-40~70°C), 85°C for 10 minutes
  - Interruptions of voltage supply class S1
  - Supply change over class C1, C2
- EMC EN 50121-3-2: 2016
- Environment EN 60068-2-1, EN 60068-2-2, EN 60068-2-30
- Shock and vibration IEC 61373 Class B
- Protective coating class PC1 (PC2, by request)
- EN 45545-2:2013+A1:2015 (PCB)

## Connector Numbering

The following diagrams indicate the numbers of the connectors. Use these numbers to locate the connectors' respective pinout assignments on chapter 2 of the manual.

### nROK 6222 Front View

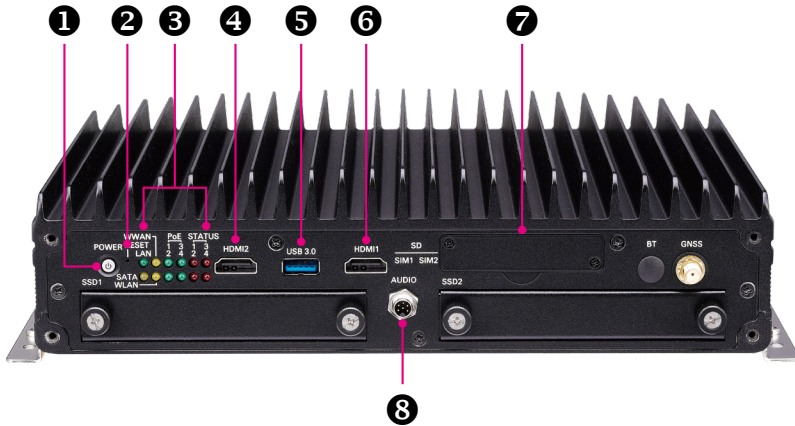

### VTC 6222 Front View





### nROK 6222 Rear View

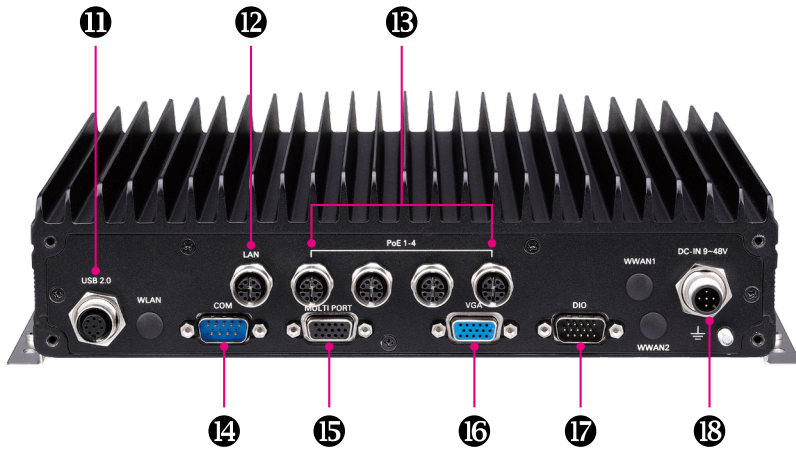

### VTC 6222 Rear View

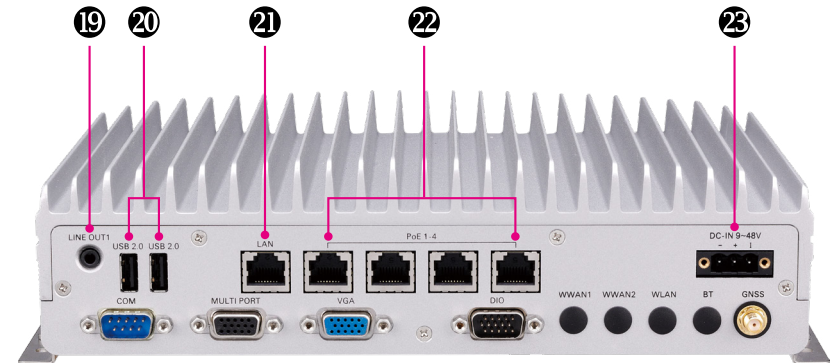

# CHAPTER 2: EXTERNAL CONNECTORS PINOUT DESCRIPTION

## Power Button

Connector number: 1



LED Color	Description
Red	Power failure
Blue	Power on and ready
Off	Power off

## Reset

Connector Number: 2

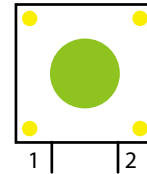

Pin	Definition
Open	Normal (Default)
Short	Reset

## SATA/LAN LED Indicators

Connector Number: 3

### LAN



### SATA

LED	LED Behavior
LAN	Blinking/On (Green): LAN activity/access
SATA	Blinking (Yellow): Storage access

## WWAN/WLAN LED Indicators

Connector Number: 3

### WWAN



### WLAN

LED	LED Behavior
WWAN	On (Yellow): WWAN active
WLAN	On (Yellow): WLAN active

## PoE LAN LED Indicators

Connector Number: 3

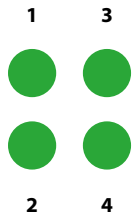

LED	LED Behavior
1	On (Green): PoE LAN1 active
2	On (Green): PoE LAN2 active
3	On (Green): PoE LAN3 active
4	On (Green): PoE LAN4 active

## STATUS LED Indicators (User Programmable)

Connector Number: 3

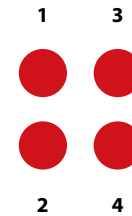

LED	LED Behavior
1	User programmable LED (Red)
2	User programmable LED (Red)
3	User programmable LED (Red)
4	User programmable LED (Red)

## HDMI Connector

Connector number: 4

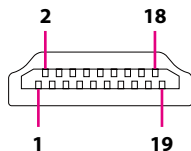

Pin	Definition	Pin	Definition
1	HDMI_TX2P_L	2	GND
3	HDMI_TX2N_L	4	HDMI_TX1P_L
5	GND	6	HDMI_TX1N_L
7	HDMI_TX0P_L	8	GND
9	HDMI_TX0N_L	10	HDMI_CLK_P_L
11	GND	12	HDMI_CLK_N_L
13	NC	14	NC
15	HDMI_SCL	16	HDMI_SDA
17	GND	18	HDMI_P5V
19	HDMI_HPD		

## USB 3.0 Port

Connector Number: 5

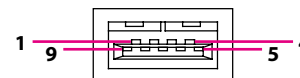

Pin	Definition	Pin	Definition
1	USB_5V	2	USB2.0_DATA-
3	USB2.0_DATA+	4	GND
5	USB3.0_RX_N	6	USB3.0_RX_P
7	GND	8	USB3.0_TX_N
9	USB3.0_TX_P		

## HDMI Connector

Connector number: 6

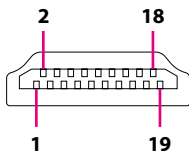

Pin	Definition	Pin	Definition
1	HDMI_TX2P_L	2	GND
3	HDMI_TX2N_L	4	HDMI_TX1P_L
5	GND	6	HDMI_TX1N_L
7	HDMI_TX0P_L	8	GND
9	HDMI_TX0N_L	10	HDMI_CLK_P_L
11	GND	12	HDMI_CLK_N_L
13	NC	14	NC
15	HDMI_SCL	16	HDMI_SDA
17	GND	18	HDMI_P5V
19	HDMI_HPD		

## SIM1 to SIM2 Mini-SIM Sockets

Connector number: 7

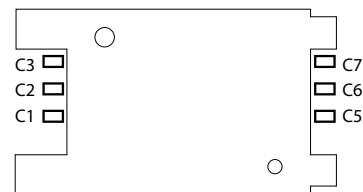

### SIM1-1/1-2 to SIM4-1/4-2

Pin	Definition	Pin	Definition
C1	UIM_PWR	C5	NC
C2	UIM_RST	C6	UIM_DAT
C3	UIM_CLK	C7	NC



Note: SIM4-1/4-2 (BOM optional)

## SD Card Slot

Connector Number: 7

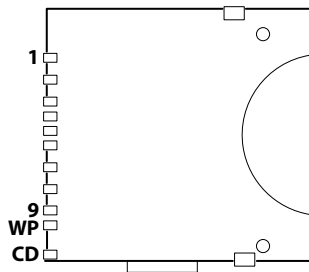

Pin	Definition	Pin	Definition
1	SD_DATA3	2	SD_CMD
3	GND	4	SD_VDD (3.3V)
5	SD_CLK	6	GND
7	SD_DATA0	8	SD_DATA1
9	SD_DATA2	WP	SD_WP
CD	SD_CD		
MH1	GND	MH2	GND

## M12 Audio Connector (nROK 6222)

Connector Number: 8

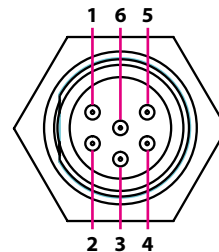

Pin	Definition	Pin	Definition
1	GND	2	MIC_JDETECT
3	MIC_L	4	LINE OUT_R
5	LINE OUT_JDETECT	6	LINE OUT_L

## Mic-in Connector

Connector Number: 9

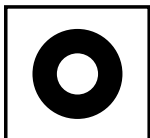

Pin	Definition	Pin	Definition
1	MIC1_R	2	MIC_JD
3	NC	4	MIC1_L
5	GND	6	GND

## Line-out2 Connector

Connector Number: 10

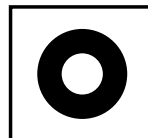

Pin	Definition	Pin	Definition
1	SURR OUT_R	2	SURR_JD
3	NC	4	SURR OUT_L
5	GND	6	GND



## M12 USB 2.0 Connector (nROK 6222)

Connector Number: 11

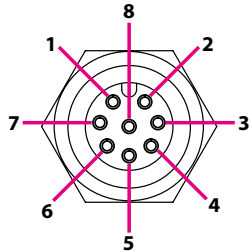

Pin	Definition	Pin	Definition
1	USB1_N	2	USB1_P
3	USB1_VCC5	4	USB1_GND
5	USB2_N	6	USB2_P
7	USB2_VCC5	8	USB2_GND

## M12 LAN Connector (nROK 6222)

Connector Number: 12

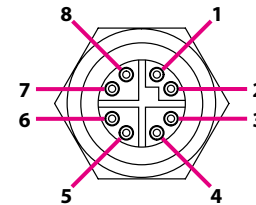

Pin	Definition	Pin	Definition
1	LAN_MDI0P	2	LAN_MDI0N
3	LAN_MDI1P	4	LAN_MDI1N
5	LAN_MDI2P	6	LAN_MDI2N
7	LAN_MDI3P	8	LAN_MDI3N

## M12 PoE LAN Connectors (nROK 6222)

Connector Number: 13

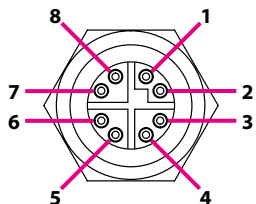

Pin	Definition	Pin	Definition
1	POE_LAN(4-1)_MDI0P	2	POE_LAN(4-1)_MDI0N
3	POE_LAN(4-1)_MDI1P	4	POE_LAN(4-1)_MDI1N
5	POE_LAN(4-1)_MDI2P	6	POE_LAN(4-1)_MDI2N
7	POE_LAN(4-1)_MDI3P	8	POE_LAN(4-1)_MDI3N

## COM Port

Connector Number: 14

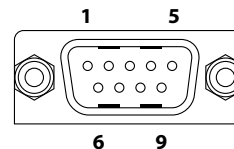

Pin	Definition	Pin	Definition
1	DCD	2	RX
3	TX	4	DTR
5	GND	6	DSR
7	RTS	8	CTS
9	RI		

## Multi Port

Connector Number: 15

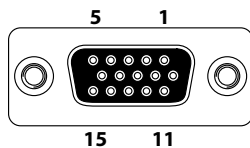

Pin	Definition	Pin	Definition
1	CAN_H	2	RS232_RX
3	RS232_TX	4	RS485_TX-
5	RS485_TX+	6	CAN_L
7	ISO_GND	8	ISO_GND
9	RS422_TX-	10	RS422_TX+
11	CANISO_GND	12	GND
13	GND	14	DC 12V
15	DC 12V		

## VGA

Connector Number: 16

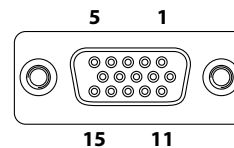

Pin	Definition	Pin	Definition
1	VGA_RED	2	VGA_GREEN
3	VGA_BLUE	4	CH7517_SPC_R
5	GND	6	GND
7	GND	8	GND
9	VGA_+5V	10	GND
11	CH7517_SPD_R	12	VGA_DATA
13	VGA_HS	14	VGA_VS
15	VGA_CLK		

## DIO

Connector Number: 17

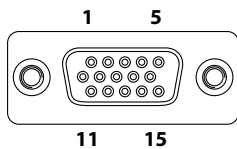

Pin	Definition	Pin	Definition
1	GPI 1	2	GPI 2
3	GPI 3	4	GPI 4
5	GPO 1	6	GPO 2
7	GPO 3	8	GPO 4
9	VIN-GPIO	10	GND

## DC Input (nROK 6222)

Connector Number: 18

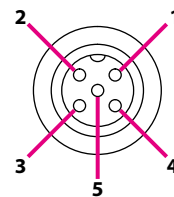

Pin	Definition	Pin	Definition
1	VIN	2	VIN
3	GND	4	GND
5	IGNITION		

## Line-out1 Connector (VTC 6222)

Connector Number: 19

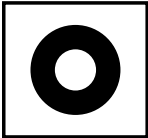

Pin	Definition	Pin	Definition
1	FRONT OUT_R	2	FRONT_JD
3	NC	4	FRONT OUT_L
5	GND	6	GND

## USB 2.0 Ports (VTC 6222)

Connector Number: 20

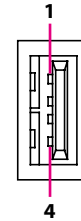

Pin	Definition	Pin	Definition
1	USB_5V	2	DATA-
3	DATA+	4	GND

## LAN Port (VTC 6222)

Connector number: 21

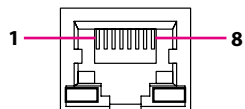

Pin	Definition	Pin	Definition
1	LAN_MDI0P	2	LAN_MDI0N
3	LAN_MDI1P	4	LAN_MDI2P
5	LAN_MDI2N	6	LAN_MDI1N
7	LAN_MDI3P	8	LAN_MDI3N
MH1	GND	MH2	GND

## PoE LAN Ports (VTC 6222)

Connector number: 22

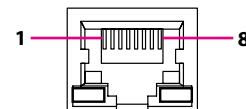

Pin	Definition	Pin	Definition
1	POE_LAN(4-1)_MDI0P	2	POE_LAN(4-1)_MDI0N
3	POE_LAN(4-1)_MDI1P	4	POE_LAN(4-1)_MDI2P
5	POE_LAN(4-1)_MDI2N	6	POE_LAN(4-1)_MDI1N
7	POE_LAN(4-1)_MDI3P	8	POE_LAN(4-1)_MDI3N
MH1	GND	MH2	GND

## DC Input 9V-48V (VTC 6222)

Connector Number: 23

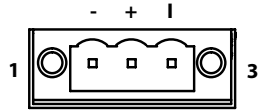

Pin	Definition
1	GND
2	VIN
3	IGNITION

# CHAPTER 3: JUMPERS AND CONNECTORS

This chapter describes how to set the jumpers on the VTC 6222 and nROK 6222 motherboard.

## Before You Begin

- Ensure you have a stable, clean working environment. Dust and dirt can get into components and cause a malfunction. Use containers to keep small components separated.
- Adequate lighting and proper tools can prevent you from accidentally damaging the internal components. Most of the procedures that follow require only a few simple tools, including the following:
  - A Philips screwdriver
  - A flat-tipped screwdriver
  - A set of jewelers screwdrivers
  - A grounding strap
  - An anti-static pad
- Using your fingers can disconnect most of the connections. It is recommended that you do not use needle-nosed pliers to disconnect connections as these can damage the soft metal or plastic parts of the connectors.
- Before working on internal components, make sure that the power is off. Ground yourself before touching any internal components, by touching a metal object. Static electricity can damage many of the electronic components. Humid environment tend to have less static electricity than

dry environments. A grounding strap is warranted whenever danger of static electricity exists.

## Precautions

Computer components and electronic circuit boards can be damaged by discharges of static electricity. Working on the computers that are still connected to a power supply can be extremely dangerous.

Follow the guidelines below to avoid damage to your computer or yourself:

- Always disconnect the unit from the power outlet whenever you are working inside the case.
- If possible, wear a grounded wrist strap when you are working inside the computer case. Alternatively, discharge any static electricity by touching the bare metal chassis of the unit case, or the bare metal body of any other grounded appliance.
- Hold electronic circuit boards by the edges only. Do not touch the components on the board unless it is necessary to do so. Don't flex or stress the circuit board.
- Leave all components inside the static-proof packaging that they shipped with until they are ready for installation.
- Use correct screws and do not over tighten screws.



## Jumper Settings

A jumper is the simplest kind of electric switch. It consists of two metal pins and a cap. When setting the jumpers, ensure that the jumper caps are placed on the correct pins. When the jumper cap is placed on both pins, the jumper is short. If you remove the jumper cap, or place the jumper cap on just one pin, the jumper is open.

Refer to the illustrations below for examples of what the 2-pin and 3-pin jumpers look like when they are short (on) and open (off).

Two-Pin Jumpers: Open (Left) and Short (Right)

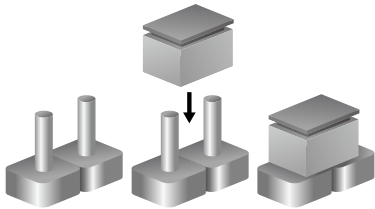

Three-Pin Jumpers: Pins 1 and 2 are Short

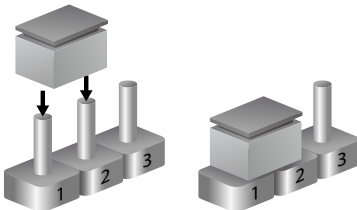

# VTC 6222 and nROK 6222 Connector Specification & Jumper Setting

## VTC 6222 and nROK 6222 Carrier Board Placement

The figure below is the carrier board used in the VTC 6222 system. It shows the locations of the jumpers and connectors.

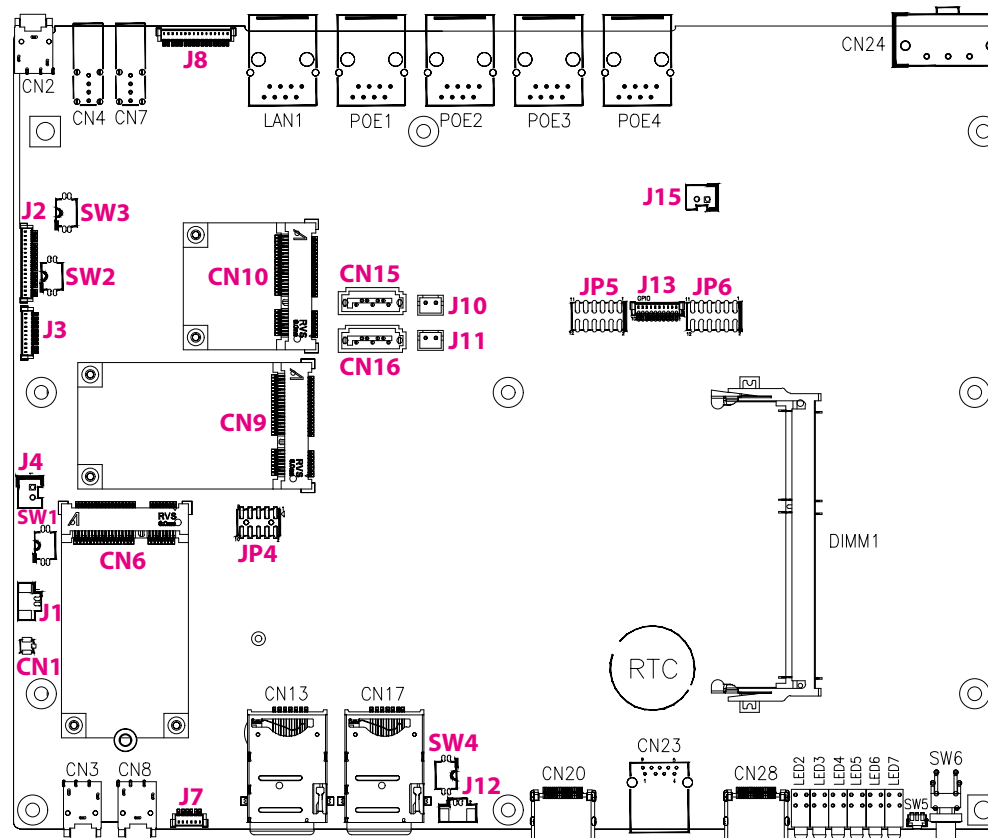

## Jumper and DIP Switch Settings

### GPO Pull High Selection

Connector type: 2x6 12-pin header, 2.0mm pitch  
Connector location: JP5

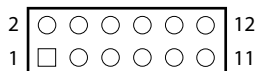

Pin	Definition
1-3 Short	GPO1 Pull High (Default) Voltage by Vin
3-5 Short	GPO1 Float
9-7 Short	GPO2 Pull High (Default) Voltage by Vin
9-11 Short	GPO2 Float
4-2 Short	GPO3 Pull High (Default) Voltage by Vin
4-6 Short	GPO3 Float
10-8 Short	GPO4 Pull High (Default) Voltage by Vin
10-12 Short	GPO4 Float

### GPI Pull High Selection

Connector type: 2x6 12-pin header, 2.0mm pitch  
Connector location: JP6

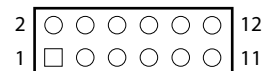

Pin	Definition
1-3 Short	GPI1 Activity Low (Default) Voltage by Vin
3-5 Short	GPI1 Activity High
7-9 Short	GPI2 Activity Low (Default) Voltage by Vin
9-11 Short	GPI2 Activity High
2-4 Short	GPI3 Activity Low (Default) Voltage by Vin
4-6 Short	GPI3 Activity High
8-10 Short	GPI4 Activity Low (Default) Voltage by Vin
10-12 Short	GPI4 Activity High

## Input Voltage Selection Switch

Connector type: 2-pin DIP switch  
Connector location: SW1

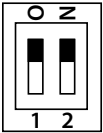

Pin	Definition
1 OFF, 2 OFF	12V
1 OFF, 2 ON	24V
1 ON, 2 ON	9-36V (Default)

## RS422/RS485 Terminator Resistor Selection Switch

Connector type: 2-pin DIP switch  
Connector location: SW2

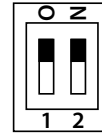

Pin	Definition
1 ON, 2 ON	RS422/RS485 Terminator Resistor (Default)
1 OFF, 2 OFF	RS422/RS485 No Terminator Resistor

## CAN Terminator Resistor Selection Switch

Connector type: 2-pin DIP switch

Connector location: SW3

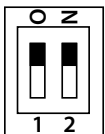

Pin	Definition
1 ON, 2 ON	CAN Terminator Resistor (Default)
1 OFF, 2 OFF	CAN No Terminator Resistor

## RTC Clear CMOS

Connector type: 2-pin DIP switch

Connector location: SW4

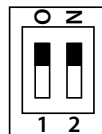

Pin	Definition
1 OFF, 2 OFF	RTC Normal (Default) ME Normal (Default)
1 ON, 2 ON	RTC Clear CMOS ME Clear

## Connectors

### GPS Module RF Connector

Connector type: 1x3 3-pin header

Connector location: CN1

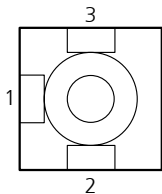

Pin	Definition
1	VCC_RF_ANT
2	GND
3	GND

### Internal Audio Header (Line-out and Mic-in)

Connector type: 1x3 3-pin header, 1.0mm pitch

Connector location: J7

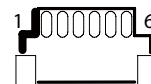

Pin	Definition	Pin	Definition
1	SURR OUT_L	2	SURR_JD
3	SURR OUT_R	4	MIC1_L
5	MIC_JD	6	GND

\* The audio header on J7 is co-layered with the audio jacks on CN3 and CN8. Default is CN3 and CN8.

\* The audio jacks on CN2, CN3 and CN8 are only available on VTC 6222.

## USB 2.0 DOM

Connector type: 2x5 10-pin header, 2.0mm pitch

Connector location: JP4

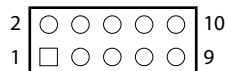

Pin	Definition	Pin	Definition
1	USB_5V	2	N.C
3	DATA-	4	N.C
5	DATA+	6	N.C
7	GND	8	N.C
9	N.C	10	N.C

## SATA Connectors

Connector type: Standard Serial ATA 7P (1.27mm, SATA-M-180)

Connector location: CN15 and CN16

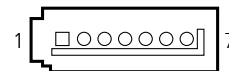

Pin	Definition	Pin	Definition
1	GND	2	SATA_TXP(1-0)
3	SATA_TXN(1-0)	4	GND
5	SATA_RXN(1-0)	6	SATA_RXP(1-0)
7	GND		

## SATA Power Connectors

Connector type: 1x2 2-pin header, 2.5mm pitch  
Connector location: J10 and J11

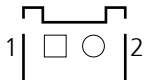

Pin	Definition
1	VCC5
2	GND

## GPS Battery Connector

Connector type: 1x2 2-pin header, 1.25mm pitch  
Connector location: J1

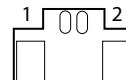

Pin	Definition
1	GND
2	GPS_RTC



## RTC Battery Connector

Connector type: 1x2 2-pin header, 1.25mm pitch

Connector location: J12

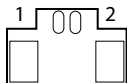

Pin	Definition
1	GND
2	RTC_BAT

## PoE Power Connector

Connector type: 1x2 2-pin header, 2.5mm pitch

Connector location: J15



Pin	Definition
1	ISO_54V_POE
2	PSE_ISOGND

## RS232/RS422/RS485/CAN Connector

Connector type: 1x16 16-pin header, 1.0mm pitch

Connector location: J2



Pin	Definition	Pin	Definition
1	CAN_H	2	CAN_L
3	CANISO_GND	4	CANISO_GND
5	CANISO_GND	6	ISO_GND
7	ISO_GND	8	ISO_GND
9	ISO_GND	10	ISO_GND
11	RS422_TX+	12	RS422_TX-
13	RS485_TX+	14	RS485_TX-
15	RS232_RXD	16	RS232_TXD

## GPIO Connector

Connector type: 1x10 10-pin header, 1.0mm pitch

Connector location: J13

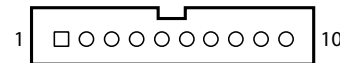

Pin	Definition	Pin	Definition
1	GPOISO_GND	2	VIN_GPIO (By VIN)
3	CON_GPO4	4	CON_GPO3
5	CON_GPO2	6	CON_GPO1
7	CON_GPI4	8	CON_GPI3
9	CON_GPI2	10	CON_GPI1

## DC 12V OUT Connector

Connector type: 1x2 2-pin header, 2.5mm pitch  
 Connector location: J4

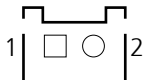

Pin	Definition
1	12V_OUT
2	GND

## Internal RS232 COM1 Connector

Connector type: 1x10 10-pin header, 1.0mm pitch  
 Connector location: J3

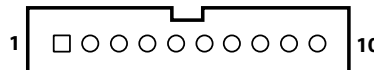

Pin	Definition	Pin	Definition
1	GND	2	GND
3	SP_CTS_1	4	SP_DSR_1
5	SP_DTR_1	6	SP_RXD_1
7	COM1_RI#_PW	8	SP_RTS_1
9	SP_TXD_1	10	SP_DCD_1

## Internal VGA Connector

Connector type: 1x16 16-pin header, 1.0mm pitch

Connector location: J8

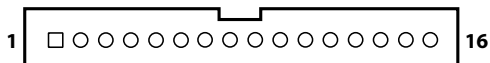

Pin	Definition	Pin	Definition
1	GND	2	VGA_+5V
3	VGA_CLK	4	VGA_DATA
5	VGA_VS	6	VGA_HS
7	GND	8	GND
9	GND	10	GND
11	VGA_BLUE	12	GND
13	VGS_GREEN	14	GND
15	VGA_RED	16	GND

## SIM1 to SIM2 Mini-SIM Slots

SIM1 Connector location: CN17

SIM2 Connector location: CN13

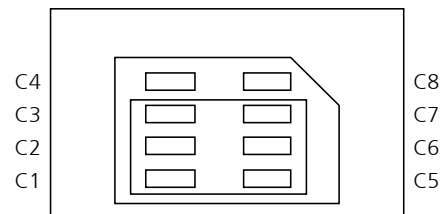

Pin	Definition	Pin	Definition
C1	SIM_PWR	C2	SIM_RST
C3	SIM_CLK	C4	NC
C5	GND	C6	NC
C7	SIM_DAT	C8	NC

## Full Size Mini-PCle Socket (USB 2.0) for LTE Module with 2 x External SIM

\* No 3G Voice

Connector location: WWAN, CN6

SIM socket: SIM 1

SIM socket: SIM 2

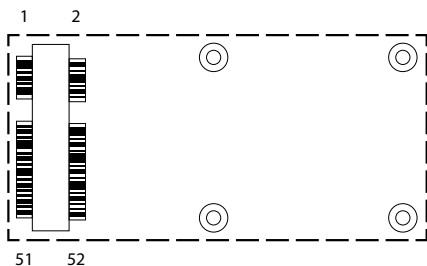

Pin	Definition	Pin	Definition
1	WAKE#_3G	2	V3.5G_P_A (+3.3V)
3	NC	4	GND
5	NC	6	NC
7	UIM2_RESET/NC	8	UIM1_PWR
9	GND	10	UIM1_DATA
11	VREF_PCIE	12	UIM1_CLK
13	UIM2_PWR/NC	14	UIM1_RESET
15	GND	16	NC
17	UIM2_CLK/NC	18	GND
19	UIM2_DATA/NC	20	3.5G_DIS#_A
21	GND	22	3.5G_RST#_A
23	USB3.0_RX1N	24	V3.5G_P_A (+3.3V)
25	USB3.0_RX1P	26	GND

Pin	Definition	Pin	Definition
27	GND	28	NC
29	GND	30	NC
31	USB3.0_TX1N	32	NC
33	USB3.0_TX1P	34	GND
35	GND	36	USB_ON
37	GND	38	USB_OP
39	V3.5G_P_A (+3.3V)	40	GND
41	V3.5G_P_A (+3.3V)	42	3.5G_LED#_A
43	GND	44	NC
45	NC	46	NC
47	NC	48	NC
49	NC	50	GND
51	NC	52	V3.5G_P_A(+3.3V)

## Full Size Mini-PCIe Socket (USB 2.0, PCIe 2.0)

Connector location: CN9

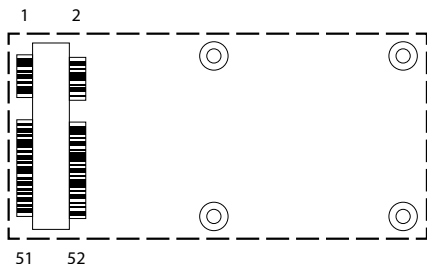

Pin	Definition	Pin	Definition
1	PCIE_WAKE#1	2	+V3.3_MINI_1
3	N.C	4	GND
5	N.C	6	+V1.5S_MINI_1
7	PCIE_CLKREQ1#	8	NC
9	GND	10	NC
11	PCIE_CLKN1	12	NC
13	PCIE_CLKP1	14	NC
15	GND	16	NC
17	N.C	18	GND
19	N.C	20	WIFI_DIS#_a
21	GND	22	PCIE_RST#
23	PCIE_RXN1	24	+V3.3_MINI_1
25	PCIE_RXP1	26	GND

Pin	Definition	Pin	Definition
27	GND	28	+V1.5S_MINI_1
29	GND	30	NC
31	PCIE_TXN1	32	NC
33	PCIE_TXP1	34	GND
35	GND	36	USB_3N
37	GND	38	USB_3P
39	+V3.3_MINI_1	40	GND
41	+V3.3_MINI_1	42	N.C
43	GND	44	WLAN_LED#_A
45	NC	46	N.C
47	NC	48	+V1.5S_MINI_1
49	NC	50	GND
51	BT_DIS#_A	52	+V3.3_MINI_1

## Half Size Mini-PCIe Socket (USB 2.0, PCIe 2.0)

Connector location: CN10

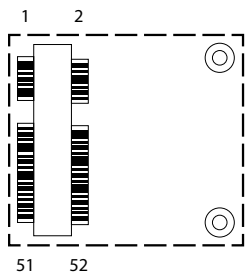

Pin	Definition	Pin	Definition
1	PCIE_WAKE#2	2	+V3.3_MINI_2
3	N.C	4	GND
5	N.C	6	+V1.5S_MINI_2
7	PCIE_CLKREQ2#	8	NC
9	GND	10	NC
11	PCIE_CLKN2	12	NC
13	PCIE_CLKP2	14	NC
15	GND	16	NC
17	N.C	18	GND
19	N.C	20	WIFI_DIS#_B
21	GND	22	PCIE_RST#
23	PCIE_RXN2	24	+V3.3_MINI_2
25	PCIE_RXP2	26	GND

Pin	Definition	Pin	Definition
27	GND	28	+V1.5S_MINI_2
29	GND	30	NC
31	PCIE_TXN2	32	NC
33	PCIE_TXP2	34	GND
35	GND	36	USB_4N
37	GND	38	USB_4P
39	+V3.3_MINI_2	40	GND
41	+V3.3_MINI_2	42	N.C
43	GND	44	WLAN_LED#_B
45	NC	46	N.C
47	NC	48	+V1.5S_MINI_2
49	NC	50	GND
51	BT_DIS#_B	52	+V3.3_MINI_2

# CHAPTER 4: SYSTEM SETUP

## Removing the Chassis Cover



Prior to removing the chassis cover, make sure the unit's power is off and disconnected from the power sources to prevent electric shock or system damage.

1. The screws on the front, rear and sides are used to secure the cover to the chassis. Remove these screws and put them in a safe place for later use. With the screws removed, pull up the bottom cover to remove it.



Bottom View



Front View



Rear View



## Installing a SSD/HDD Drive

1. Loosen the thumb screws on the SSD/HDD drive bay and slide the drive bay out.



**Thumb  
Screws**

2. Insert the storage drive into the drive bay with the SATA data and power connector facing towards the end. Align the storage drive's mounting holes with the mounting holes on the drive bay, and use the provided screws to secure the storage drive in place.



**SATA  
Data/Power  
Connector**

**Mounting  
Screws**

3. Insert the drive bay back in the SSD/HDD slot and tighten the thumb screws to secure it in place.



## Inserting SIM Cards

1. Remove the SIM/SD card cover on the front panel and insert the SIM cards. Please take note of the SIM card installation direction as shown in the following picture.

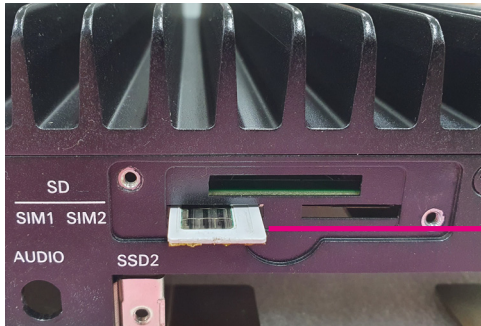

**Installation direction  
for SIM slot**

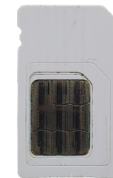

**Mini-SIM**

## Inserting an SD Card

1. Remove the SIM/SD card cover on the front panel and insert the SD card. Please take note of the SD card installation direction as shown in the following picture.

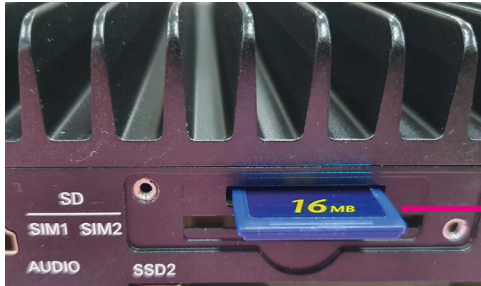

Installation direction  
for SD card



## Installing a WLAN Module

1. Locate the WLAN mini PCI Express slot (CN10). Insert the module into the mini PCI Express slot at a 45 degrees angle until the gold-plated connector on the edge of the module completely disappears inside the slot. Then fasten a screw into the mounting hole to secure the module.

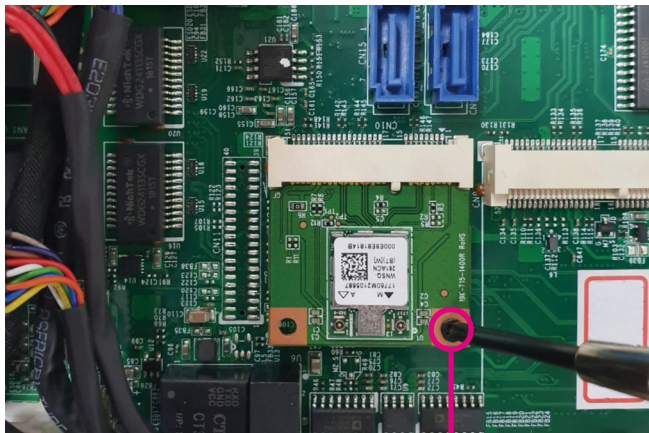

**Mounting  
Screw**

## Installing a WWAN Module

1. Locate the WWAN mini PCI Express slot (CN6). Insert the module into the mini PCI Express slot at a 45 degrees angle until the gold-plated connector on the edge of the module completely disappears inside the slot. Then fasten a screw into the mounting hole to secure the module.

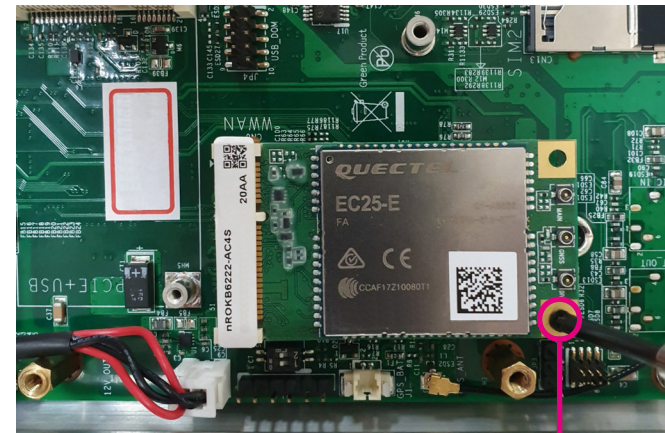

**Mounting  
Screw**

## Installing a SO-DIMM Memory Module

1. Push the ejector tabs which are at the ends of the socket outward. Then insert the module into the socket at an approximately 30 degrees angle. Apply firm even pressure to each end of the module until it slips down into the socket. The contact fingers on the edge of the module will almost completely disappear inside the socket.

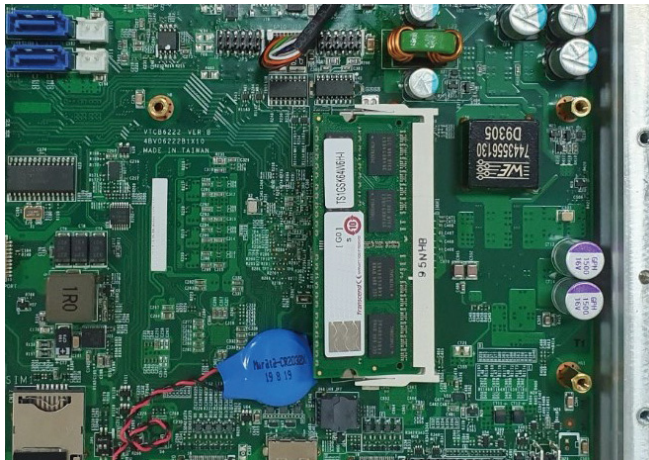

# APPENDIX A:

## SOFTWARE DEMO UTILITY FOR I/O PORTS OF FUNCTION CONTROL

NEXCOM's software demo utility enables users to test and control different I/O port functions on VTC 6222 and nROK 6222. This document shows how to use the utility.

There are also source code files of the utility in the CD. Users can refer to the source codes to develop their applications.

## Menu Screen

### 1. System 1

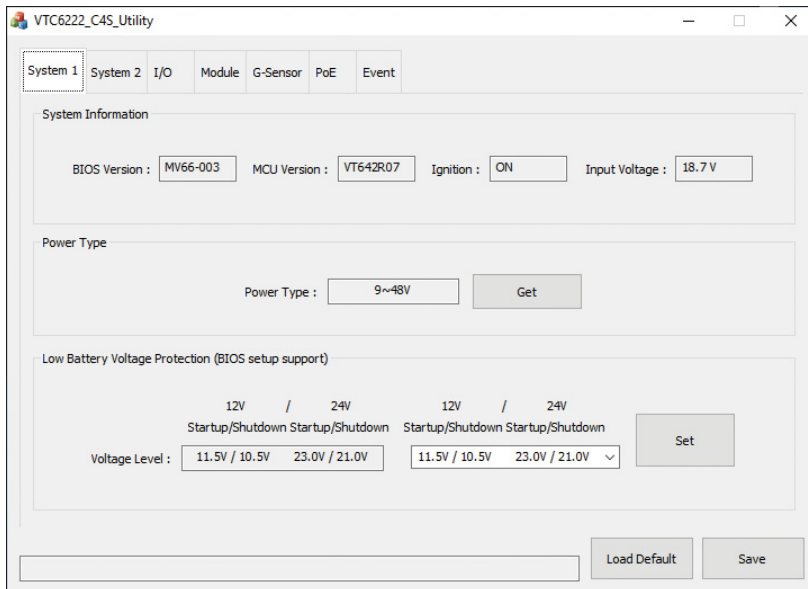

The screenshot shows the VTC6222\_C4S\_Utility application window. The 'System 1' tab is selected. The 'System Information' section displays the following fields:

- BIOS Version: MV66-003
- MCU Version: VT642R07
- Ignition: ON
- Input Voltage: 18.7 V

The 'Power Type' section shows:

- Power Type: 9~48V
- Get button

The 'Low Battery Voltage Protection (BIOS setup support)' section shows:

- Two voltage level settings for 12V and 24V, each with Startup/Shutdown and Startup/Shutdown options.
- Current settings: 11.5V / 10.5V and 23.0V / 21.0V.
- Set button

At the bottom, there are 'Load Default' and 'Save' buttons.

#### 1.1 System Information

Displays basic information of the system.

BIOS Version: Shows the BIOS version.

MCU Version: Shows the MCU version.

Ignition: Shows the signal of ignition.

- ON: Signal of ignition is high.

- OFF: Signal of ignition is low.

Input Voltage: Shows the voltage level of power-in.



This inset screenshot shows the 'System Information' section of the utility, displaying the same fields as the main screenshot:

- BIOS Version: MV66-003
- MCU Version: VT642R07
- Ignition: ON
- Input Voltage: 18.7 V

## 1.2 Power Type

Shows the input voltage setting in the SW DIP switch.

- If the setting is 12V: 12V is shown.
- If the setting is 24V: 24V is shown.
- If the setting is 9V~48V: 9V~48V is shown.



Power Type

Power Type : 9~48V Get

## 1.3 Low Battery Voltage Protection

Configures the Low Battery Voltage Protection Startup/Shutdown voltage level during 12V/24V.

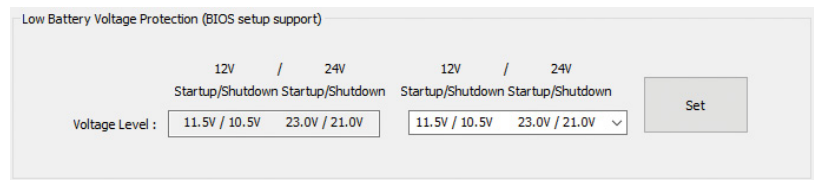

Low Battery Voltage Protection (BIOS setup support)

12V / 24V 12V / 24V

Startup/Shutdown Startup/Shutdown Startup/Shutdown Startup/Shutdown

Voltage Level : 11.5V / 10.5V 23.0V / 21.0V 11.5V / 10.5V 23.0V / 21.0V Set



## 2. System 2

The screenshot shows the VTC6222\_C45\_Utility application window with the 'System 2' tab selected. The interface includes several configuration sections:

- Power On/Off Delay Timer (BIOS setup support):**
  - Power Off Delay:    Delay Off Time:
  - Power On Delay:    Delay On Time:
- RTC Wake Up Timer (BIOS setup support):**
  - RTC Wake Up:
  - Timer Setting: Hour:    Min:    Sec:
- Watchdog Timer:**
  - WDT:
  - Time interval:

At the bottom of the window are buttons for 'Load Default' and 'Save'.

### 2.1 Power On/Off Delay Timer

Configures the power on/off delay timer. Click the Set button after configuration to apply the settings.

This panel shows the configuration for the Power On/Off Delay Timer. It includes:

- Power Off Delay:    Delay Off Time:
- Power On Delay:    Delay On Time:

### 2.2 RTC Wake Up Timer

Enables or disables the Alarm Wake Up function. Once this function is enabled, the Alarm Timer can be configured.

This panel shows the configuration for the RTC Wake Up Timer. It includes:

- RTC Wake Up:
- Timer Setting: Hour:    Min:    Sec:

### 2.3 Watchdog Timer

Enables or disables the Watchdog Timer function. There are several selections of time. The timer of Watchdog Timer can also be cleared by the Set WDT button.

This panel shows the configuration for the Watchdog Timer. It includes:

- WDT:
- Time interval:

### 3. I/O

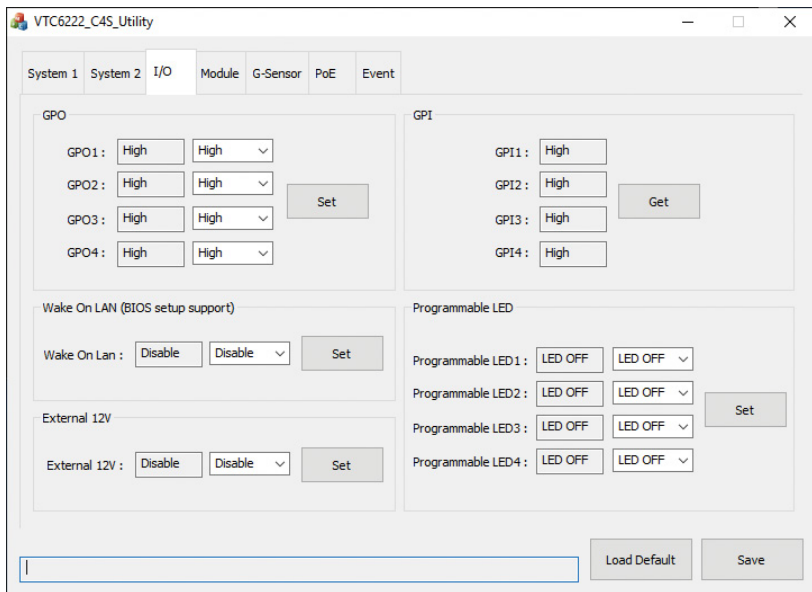

#### 3.1 GPO

Configures GPO as high voltage level or low voltage level.

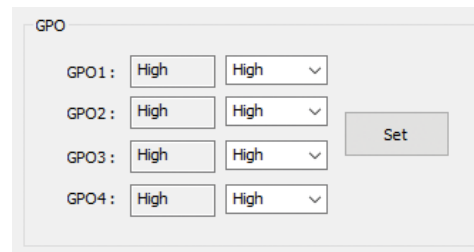

#### 3.2 GPI

Reads the status (voltage level) of GPI.



### 3.3 Wake On Lan

Enables or disables the Wake On LAN function.



Wake On LAN (BIOS setup support)

Wake On Lan :

### 3.4 External 12V

Enables or disables the External 12V function.

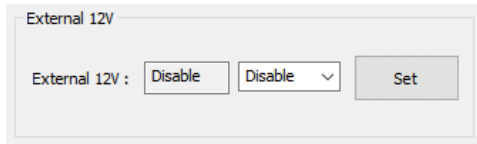

External 12V

External 12V :

### 3.5 Programmable LED

Defines the Programmable LED as on or off.

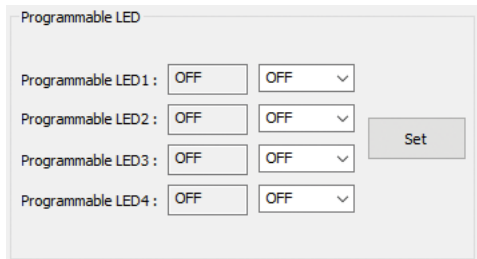

Programmable LED

Programmable LED1 :

Programmable LED2 :

Programmable LED3 :

Programmable LED4 :

## 4. Module

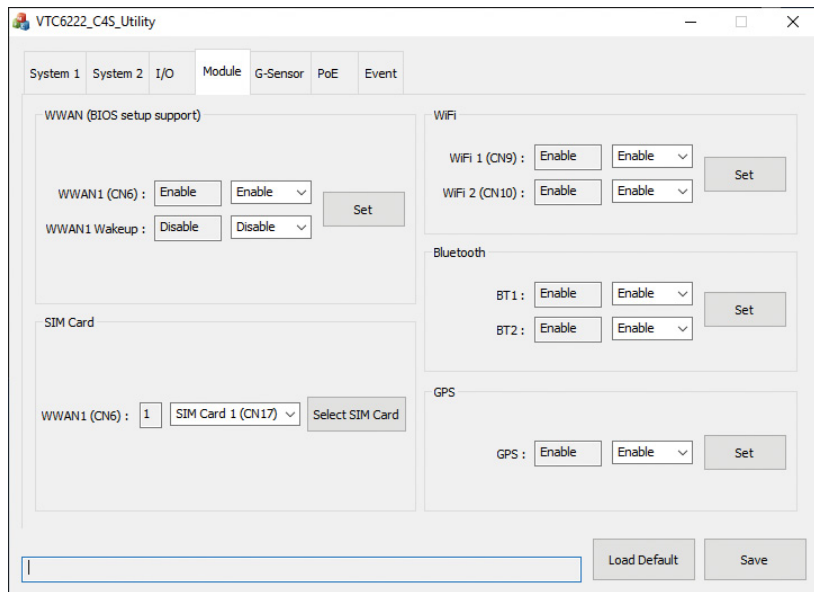

### 4.1 WWAN

Enables or disables the WWAN1 function on CN6 mini-PCIe socket.  
 Enables or disables the WWAN1 wakeup function.  
 The setting can also be cleared by the Set button.

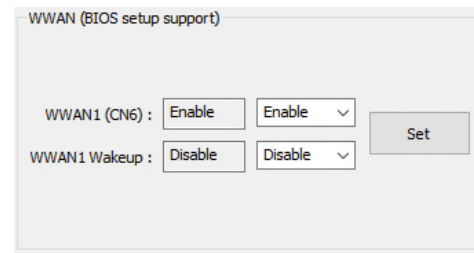

### 4.2 SIM Card

Selects the SIM card setting on WWAN1 is from SIM CARD1 or SIM CARD2.  
 Click the Select SIM Card button after configuration to apply the settings.

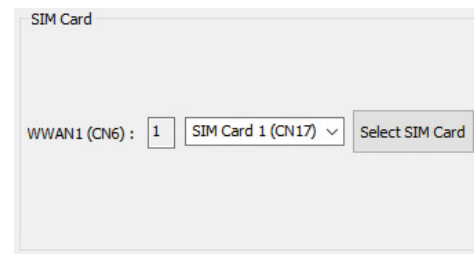

### 4.3 WiFi

Enables or disables the Wi-Fi module function on CN9 mini-PCIe socket.  
Enables or disables the Wi-Fi module function on CN10 mini-PCIe socket.  
The setting can also be cleared by the Set button.

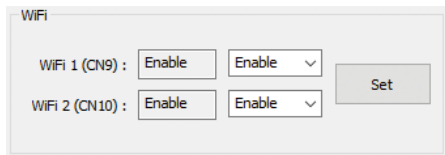

WiFi

WiFi 1 (CN9) :   ▾

WiFi 2 (CN10) :   ▾

### 4.4 Bluetooth

Enables or disables the BT1 (CN9) function.  
Enables or disables the BT2 (CN10) function.  
The setting can also be cleared by the Set button.

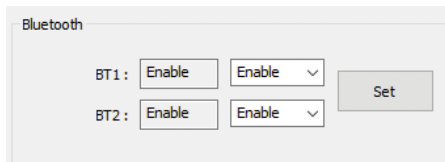

Bluetooth

BT1 :   ▾

BT2 :   ▾

### 4.5 GPS

Enables or disables the GPS function.

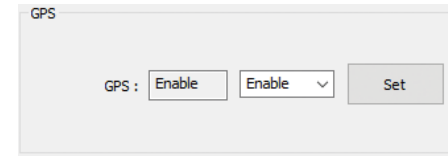

GPS

GPS :   ▾

## 5. G-Sensor

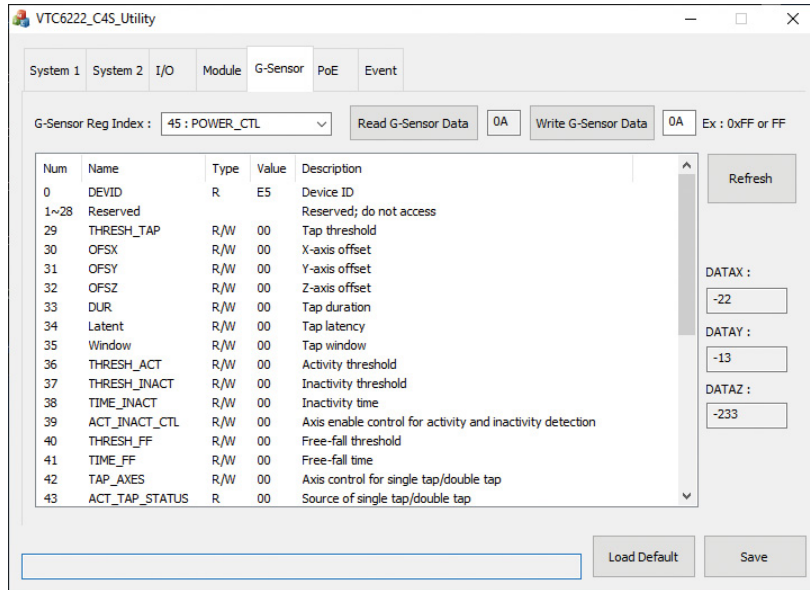

### 5.1 G-Sensor Register Index

Selects the registers inside G-Sensor to read or write the data.

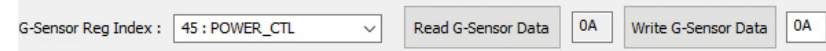

### 5.2 Register Table

Shows the value of all registers in G-Sensor, once the Refresh Button is pressed.

Num	Name	Type	Value	Description
0	DEVID	R	E5	Device ID
1~28	Reserved			Reserved; do not access
29	THRESH_TAP	R/W	00	Tap threshold
30	OSFX	R/W	00	X-axis offset
31	OSFY	R/W	00	Y-axis offset
32	OSFZ	R/W	00	Z-axis offset
33	DUR	R/W	00	Tap duration
34	Latent	R/W	00	Tap latency
35	Window	R/W	00	Tap window
36	THRESH_ACT	R/W	00	Activity threshold
37	THRESH_INACT	R/W	00	Inactivity threshold
38	TIME_INACT	R/W	00	Inactivity time
39	ACT_INACT_CTL	R/W	00	Axis enable control for activity and inactivity detection
40	THRESH_FF	R/W	00	Free-fall threshold
41	TIME_FF	R/W	00	Free-fall time
42	TAP_AXES	R/W	00	Axis control for single tap/double tap
43	ACT_TAP_STATUS	R	00	Source of single tap/double tap

## 6. PoE

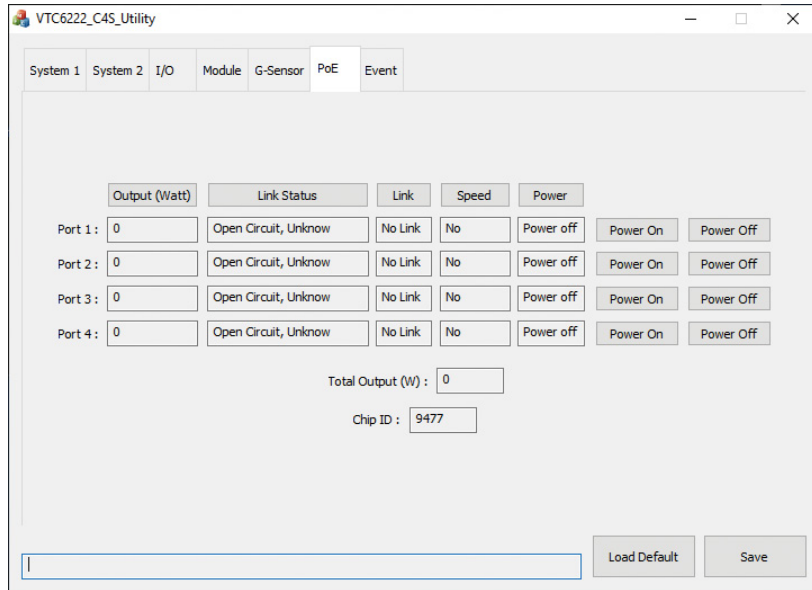

### 6.1 PoE

Shows the status of PoE power output.

	Output (Watt)	Link Status	Link	Speed	Power
Port 1 :	0	Open Circuit, Unknown	No Link	No	Power off
Port 2 :	0	Open Circuit, Unknown	No Link	No	Power off
Port 3 :	0	Open Circuit, Unknown	No Link	No	Power off
Port 4 :	0	Open Circuit, Unknown	No Link	No	Power off

Output (Watt): Shows the power output of each PoE port.

Link Status/Link: Shows the status of the PoE link.

Speed: Shows the speed of the PoE link.

Power: Shows the status of the PoE power output.

Power On Button: Enables PoE power output.

Power Off Button: Disables PoE power output.

### 6.2 Total Output (W)

Shows the total power output of all PoE ports.



## 7. Event

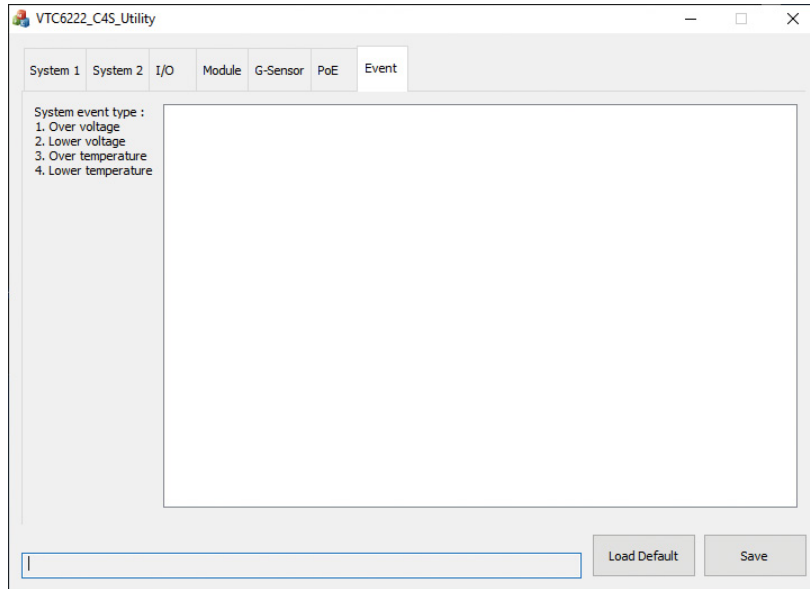

The Event tab shows the following alarm messages:

1. Over voltage alarm
2. Lower voltage alarm
3. Over temperature alarm
4. Lower temperature alarm

### (Information)

Date: YYMMDD

Time: HHMMSS

GPS Status: 0: Searching 1: Fixed

GPS Latitude

GPS Longitude

G Sensor X value: 0 ~ 65535

G Sensor Y value: 0 ~ 65535

G Sensor Z value: 0 ~ 65535

**Activation Time:** Define when tracker function starts after ignition signal becomes low.

**Send Period:** Define the interval time to send the information to server, when Tracker Mode is "Continue".

**Acceleration Force:** Define the value of G-sensor that triggers the event.

**Tilt Angle:** Define the value of tilt angle that triggers the event.

**IMEI:** IMEI of WWAN module will be shown.



# APPENDIX B: GPS FEATURE

## uBlox-NEO M8 Overview

*\*The GPS is an onboard module on the system.*

The NEO-M8 series of standalone concurrent GNSS modules is built on the exceptional performance of the u-blox M8 GNSS (GPS, GLONASS, Galileo, BeiDou, QZSS and SBAS) engine in the industry proven NEO form factor.

The NEO-M8 series provides high sensitivity and minimal acquisition times while maintaining low system power. The NEO-M8M is optimized for cost sensitive applications, while NEO-M8N and NEO-M8Q provide best performance and easier RF integration. The NEO form factor allows easy migration from previous NEO generations. Sophisticated RF-architecture and interference suppression ensure maximum performance even in GNSS-hostile environments.

The NEO-M8 combines a high level of robustness and integration capability with flexible connectivity options. The future-proof NEO-M8N includes an internal Flash that allows simple firmware upgrades for supporting additional GNSS systems. This makes NEO-M8 perfectly suited to industrial and automotive applications.

The DDC (I<sup>2</sup>C compliant) interface provides connectivity and enables synergies with most u-blox cellular modules. For RF optimization the NEO-M8N/Q features an additional front-end LNA for easier antenna integration and a front-end SAW filter for increased jamming immunity.

u-blox M8 modules use GNSS chips qualified according to AEC-Q100, are manufactured in ISO/TS 16949 certified sites, and fully tested on a system level. Qualification tests are performed as stipulated in the ISO16750 standard: “Road vehicles – Environmental conditions and testing for electrical and electronic equipment”.

## Technical Specifications

### Features

<b>Receiver type</b>	72-channel u-blox M8 engine GPS/QZSS L1 C/A, GLONASS L10F, BeiDou B1 SBAS L1 C/A: WAAS, EGNOS, MSAS Galileo-ready E1B/C (NEO-M8N)		
<b>Nav. update rate<sup>1</sup></b>	Single GNSS: up to 18 Hz Concurrent GNSS: up to 10 Hz		
<b>Position accuracy</b>	2.0 m CEP		
<b>Acquisition</b>		NEO-M8N/Q	NEO-M8M
	Cold starts:	26 s	27 s
	Aided starts:	2 s	4 s
	Reacquisition:	1 s	1 s
<b>Sensitivity</b>			
	Tracking & Nav:	-167 dBm	-164 dBm
	Cold starts:	-148 dBm	-147 dBm
	Hot starts:	-156 dBm	-156 dBm
<b>Assistance</b>	AssistNow GNSS Online AssistNow GNSS Offline (up to 35 days) AssistNow Autonomous (up to 6 days) OMA SUPL & 3GPP compliant		
<b>Oscillator</b>	TCXO (NEO-M8N/Q), Crystal (NEO-M8M)		
<b>RTC crystal</b>	Built-in		
<b>Noise figure</b>	On-chip LNA (NEO-M8M). Extra LNA for lowest noise figure (NEO-M8N/Q)		

## Features cont.

---

<b>Anti jamming</b>	Active CW detection and removal. Extra onboard SAW band pass filter (NEO-M8N/Q)
<b>Memory</b>	ROM (NEO-M8M/Q) or Flash (NEO-M8N)
<b>Supported antennas</b>	Active and passive
<b>Odometer</b>	Travelled distance
<b>Data-logger</b>	For position, velocity, and time (NEO-M8N)

<sup>1</sup> For NEO-M8M/Q

## Electrical data

---

<b>Supply voltage</b>	1.65 V to 3.6 V (NEO-M8M) 2.7 V to 3.6 V (NEO-M8N/Q)
<b>Power consumption<sup>2</sup></b>	23 mA @ 3.0 V (continuous) 5 mA @ 3.0 V Power Save Mode (1 Hz, GPS only)
<b>Backup Supply</b>	1.4 to 3.6 V

<sup>2</sup> NEO-M8M

## Interfaces

---

<b>Serial interfaces</b>	1 UART 1 USBV2.0 full speed 12 Mbit/s 1 SPI (optional) 1 DDC (I <sup>2</sup> C compliant)
<b>Digital I/O</b>	Configurable timepulse 1 EXTINT input for Wakeup
<b>Timepulse</b>	Configurable 0.25 Hz to 10 MHz
<b>Protocols</b>	NMEA, UBX binary, RTCM

### COM Port for GPS: COM 4

Baud Rate: 9600

# APPENDIX C: SIGNAL CONNECTION OF MCU DI/DO

## GPIO Pinout Description

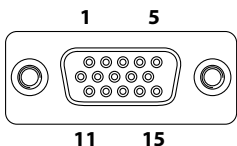

Pin	Definition	Pin	Definition
1	GPI 1	2	GPI 2
3	GPI 3	4	GPI 4
5	GPO 1	6	GPO 2
7	GPO 3	8	GPO 4
9	VIN-GPIO	10	GND

## GPO Pull High Selection (JP5)

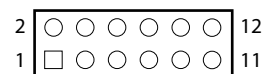

Pin	Definition
1-3 Short	GPO1 Pull High (Default) Voltage by Vin
3-5 Short	GPO1 Float
9-7 Short	GPO2 Pull High (Default) Voltage by Vin
9-11 Short	GPO2 Float
4-2 Short	GPO3 Pull High (Default) Voltage by Vin
4-6 Short	GPO3 Float
10-8 Short	GPO4 Pull High (Default) Voltage by Vin
10-12 Short	GPO4 Float

## GPI Pull High Selection (JP6)

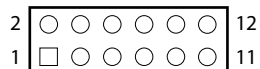

Pin	Definition
1-3 Short	GPI1 Activity Low/Internal Pull High (Default) Voltage by Vin
3-5 Short	GPI1 Activity High/External Pull High
7-9 Short	GPI2 Activity Low/Internal Pull High (Default) Voltage by Vin/External Pull High
9-11 Short	GPI2 Activity High
2-4 Short	GPI3 Activity Low/Internal Pull High (Default) Voltage by Vin
4-6 Short	GPI3 Activity High/External Pull High
8-10 Short	GPI4 Activity Low/Internal Pull High (Default) Voltage by Vin
10-12 Short	GPI4 Activity High/External Pull High

# Digital Input

J13 connector for GPI signal (digital signal input)  
 The J13 has 4 digital input channels by default.

Wet Contact (default)

The GPI signals have a pull up resistor to Vin Voltage internally.

The figure below shows how to connect an external output source to one of the input channels.

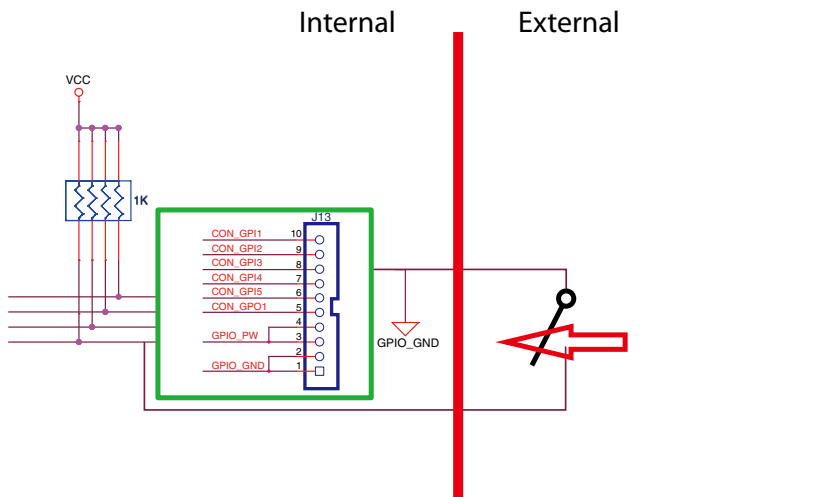

External Switch	Port	GPI Register
ON (Short)	GND	0
OFF (Open)	OPEN	1

Dry Contact:

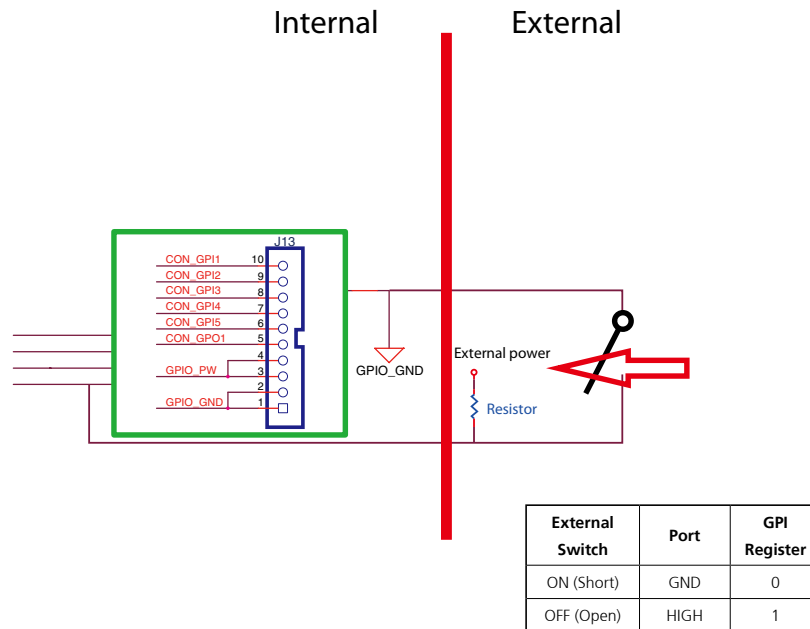

External Switch	Port	GPI Register
ON (Short)	GND	0
OFF (Open)	HIGH	1

## Digital Output

J13 connector for GPO signal (digital signal output)  
 The J13 connector has 4 digital output channels by default.

The signal connection of J13 supports two connected methods for output signal type. The output signal has two states, one is low level (driven to 0V from GPO signal) while the other is open (high voltage is provided from external device).

### Wet Contact (default)

The JP5 needs to switch to short 1-3, 7-9, 2-4 and 8-10 individually. The GPO signal will have a pull up resistor to Voltage internally. The output signal has two states, one is low level (driven to 0V from GPO signal) while the other is high level (driven to Vin Voltage).

The figure below shows how to connect an external input source to one of the output channels.

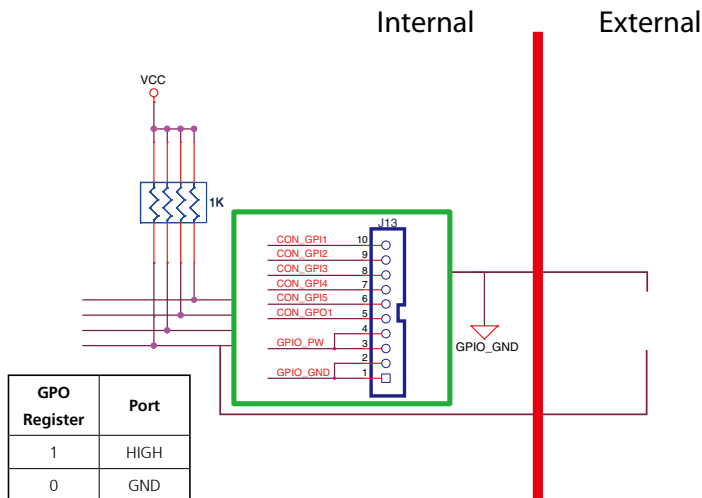

### Dry Contact

Each channel can accept 9~48Vdc voltage. And it is able to drive 4.5~24mA current for low level.

The JP5 needs to short 3-5, 9-11, 4-6 and 10-12 individually. The GPO signal will not have a pull up resistor internally.

The figure below shows how to connect an external input source to one of the output channels.

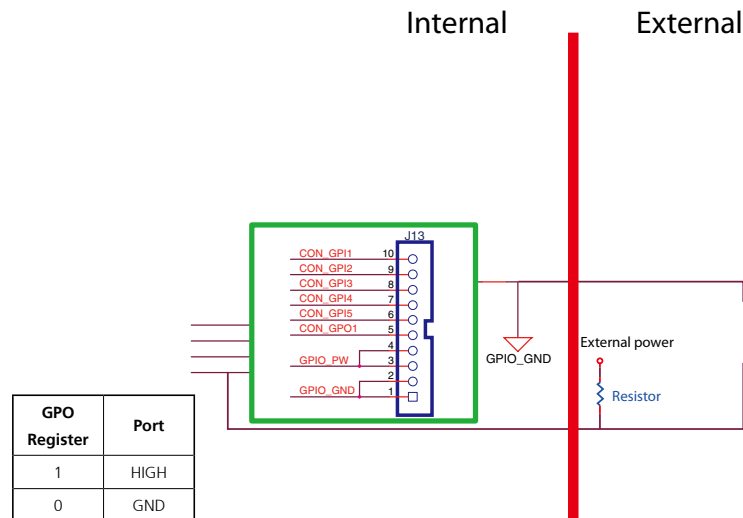

# APPENDIX D: VEHICLE POWER MANAGEMENT SETUP

## Startup and Shutdown Voltage Setting

Set the startup voltage to 11.5V or 23V and the shutdown voltage to 10.5V or 21V

If the input voltage is 12V: the startup voltage to 11.5V and the shutdown voltage to 10.5V.

If the input voltage is 24V: the startup voltage to 23V and the shutdown voltage to 21V.

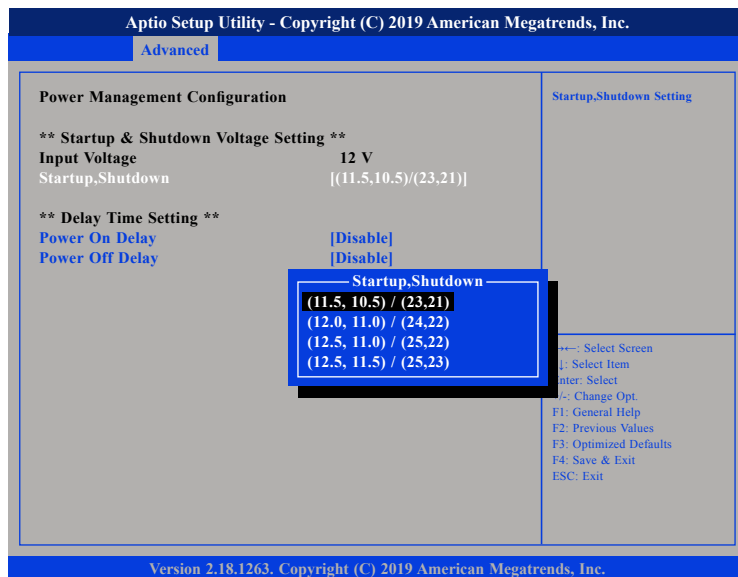

Set the startup voltage to 12.0V or 24V and the shutdown voltage to 11.0V or 22V

If the input voltage is 12V: the startup voltage to 12V and the shutdown voltage to 11V.

If the input voltage is 24V: the startup voltage to 24V and the shutdown voltage to 22V.

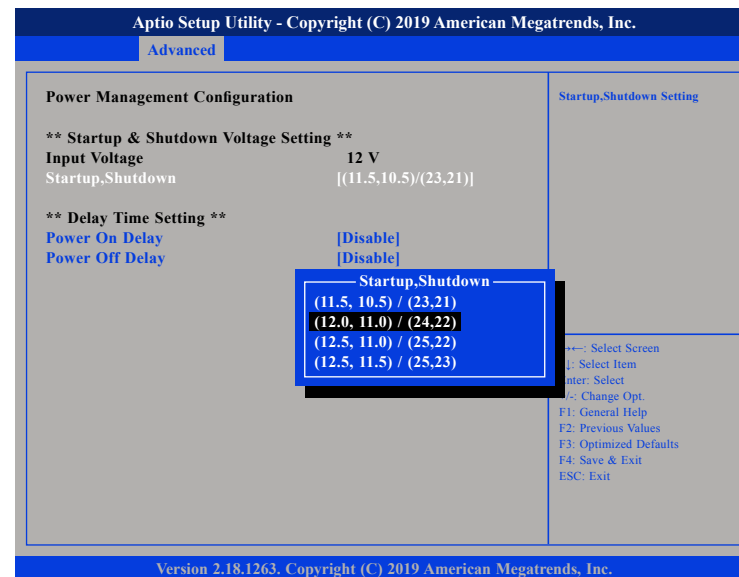

### Set the startup voltage to 12.5V or 25V and the shutdown voltage to 11.0V or 22V

If the input voltage is 12V: the startup voltage to 12.5V and the shutdown voltage to 11V.

If the input voltage is 24V: the startup voltage to 25V and the shutdown voltage to 22V.

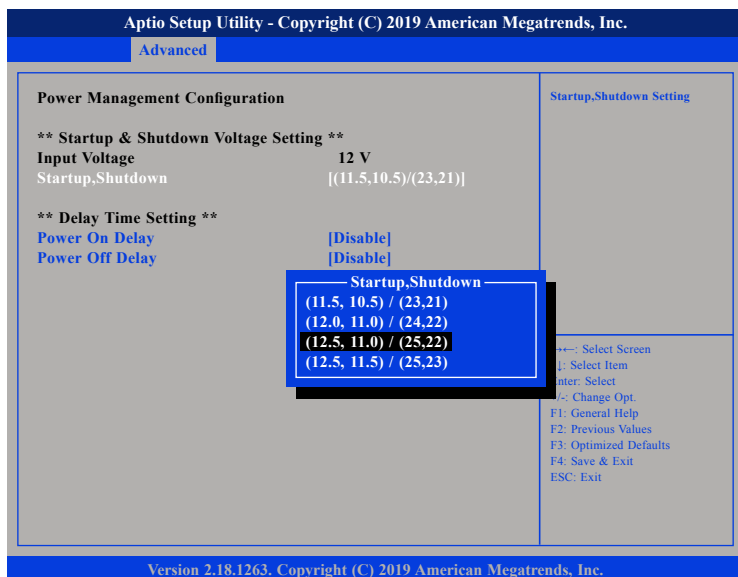

### Set the startup voltage to 12.5V or 25V and the shutdown voltage to 11.0V or 22V

If the input voltage is 12V: the startup voltage to 12.5V and the shutdown voltage to 11.5V.

If the input voltage is 24V: the startup voltage to 25V and the shutdown voltage to 23V.

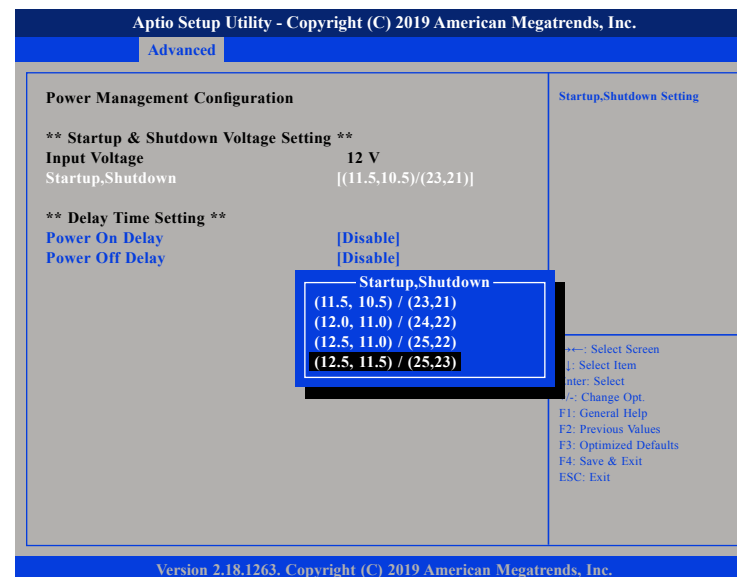



# Power-on Delay Setting

## Disable Power-on Delay

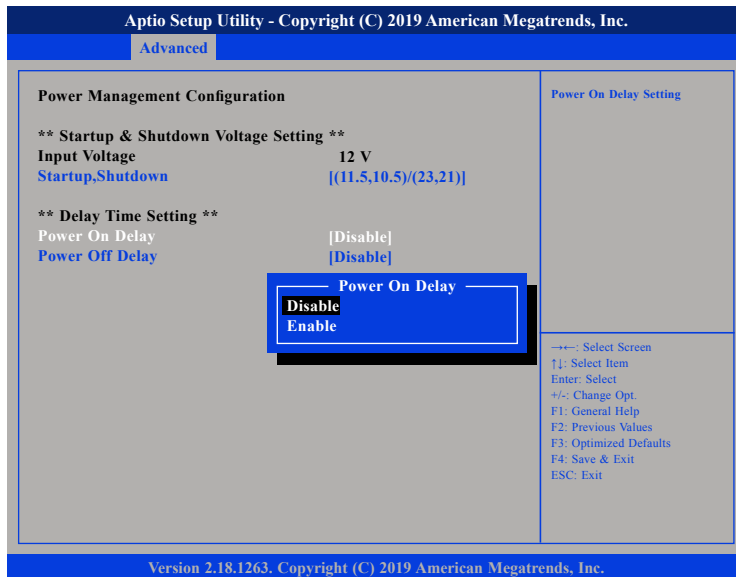

## Enable Power-on Delay

Delay time can be set at 10 sec/30 sec/1 min./5 min./10 min./15 min./30 min./1 hour.

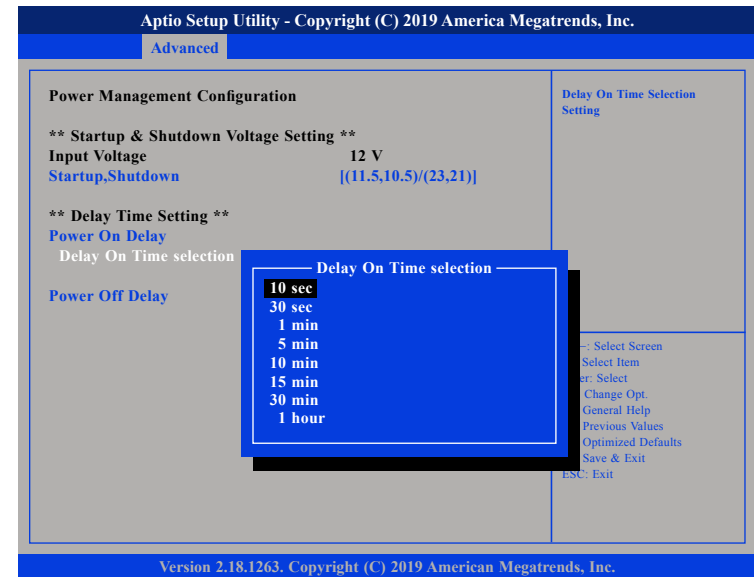
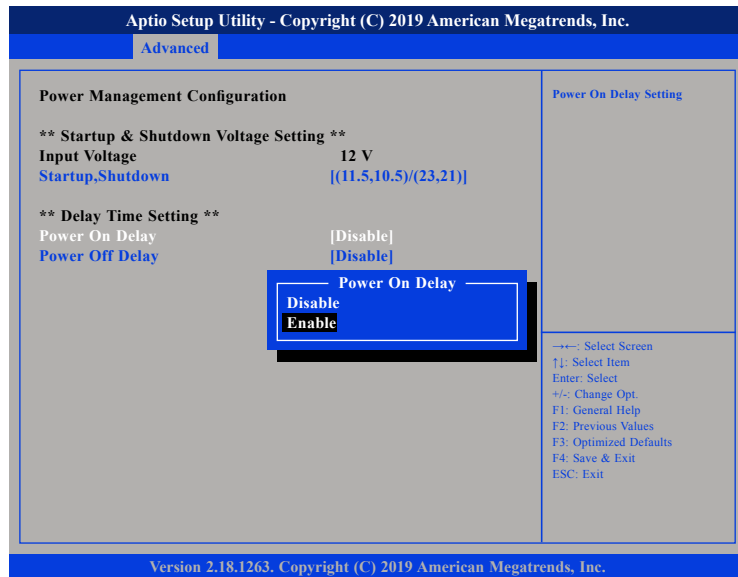

# Power-off Delay Setting

## Disable Power-off Delay

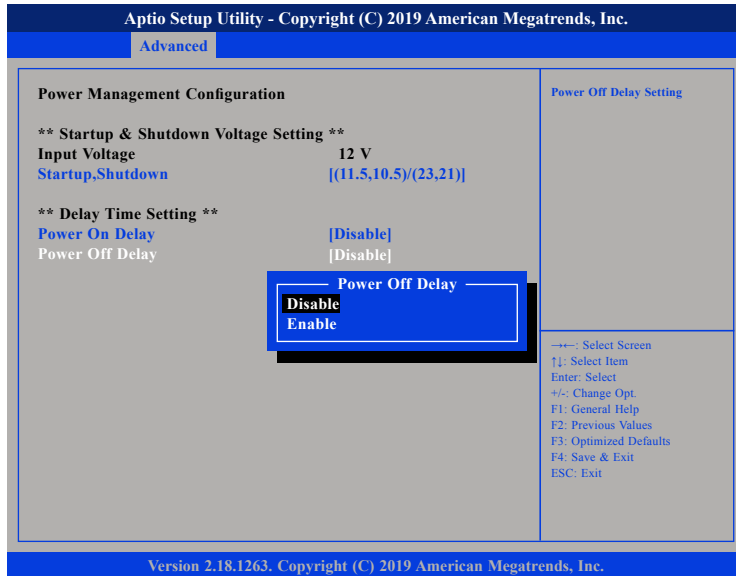

## Enable Power-off Delay

Delay time can be set at 20 sec/1 min./5 min./10 min./30 min./1 hour/6 hour/18 hour.

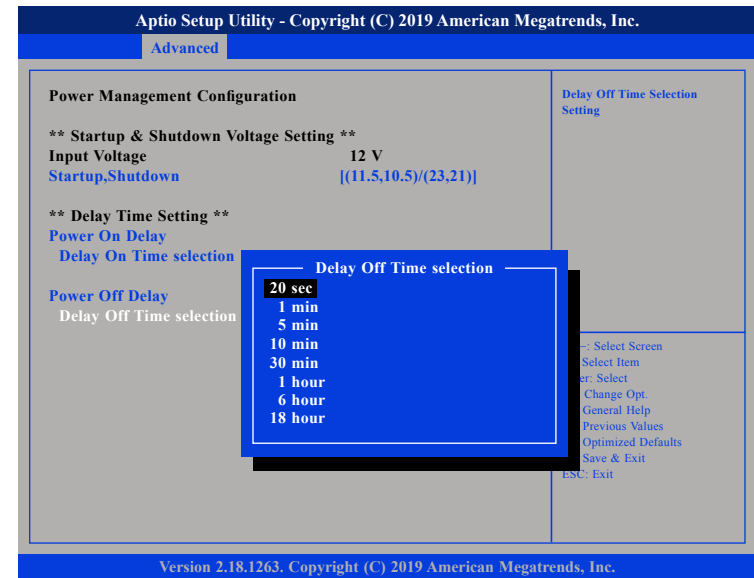
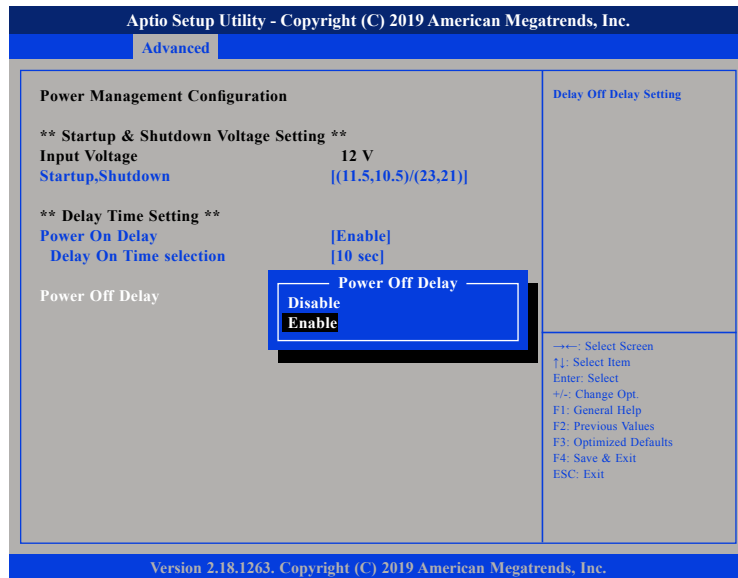

# APPENDIX E: PIN DEFINITION FOR THE MULTI PORT CABLE

The audio port consists of a 6-pin female connector and multiple output connectors. The following tables in this appendix list the pin signals of the P2 connector and its corresponding pin signals to the output connectors.

**nROK 6222 Front View**



**Audio Port Cable**

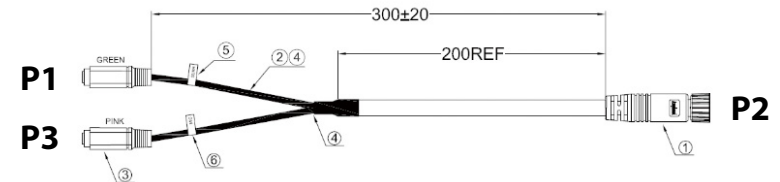

## P2 Connector Pinout

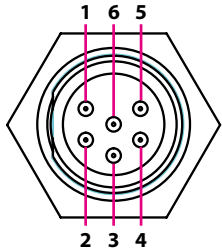

Pin	Definition	Pin	Definition
1	FRONT_L	2	FRONT_JD
3	FRONT_R	4	MIC_L
5	MIC_JD	6	AGND

## P1 and P3 Connector Pinouts Green (Line-out) Connector

Connector location: P1

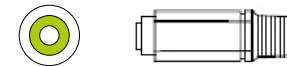

P2 Pin	P1 Pin	Definition
1	L	FRONT_L
2	G	FRONT_JD
3	R	FRONT_R

## Pink (Mic-in) Connector

Connector location: P3

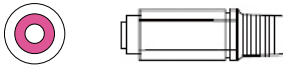

P2 Pin	P3 Pin	Definition
4	L	MIC_L
5	G	MIC_JD
6	G	AGND

The USB port consists of an 8-pin male M12 connector and multiple output connectors. The following tables in this appendix list the pin signals of the CN1 connector and its corresponding pin signals to the output connectors.

### nROK 6222 Rear View



### USB Port Cable

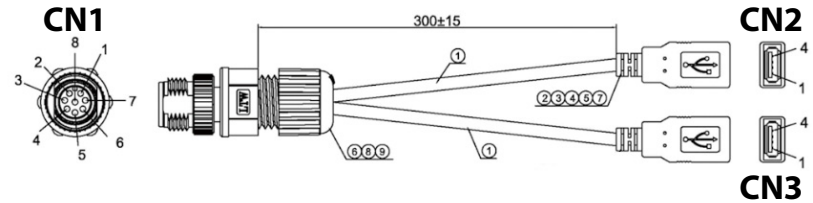



## CN1 Connector Pinout

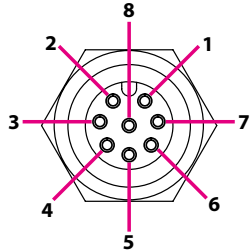

Pin	Definition	Pin	Definition
1	D-	2	D+
3	VCC	4	GND
5	D1	6	D+
7	VCC	8	GND

## CN2 and CN3 Connector Pinouts USB Connector

Connector location: CN2

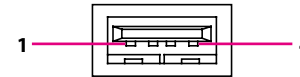

CN1 Pin	CN2 Pin	Definition
1	2	D-
2	3	D+
3	1	VCC
4	4	GND

## USB Connector

Connector location: CN3



CN1 Pin	CN3 Pin	Definition
5	2	D-
6	3	D+
7	1	VCC
8	4	GND

The multi port consists of a 15-pin male D-sub connector and multiple output connectors. The following tables in this appendix list the pin signals of the P1 connector and its corresponding pin signals to the output connectors.

### nROK 6222 Rear View



### VTC 6222 Rear View

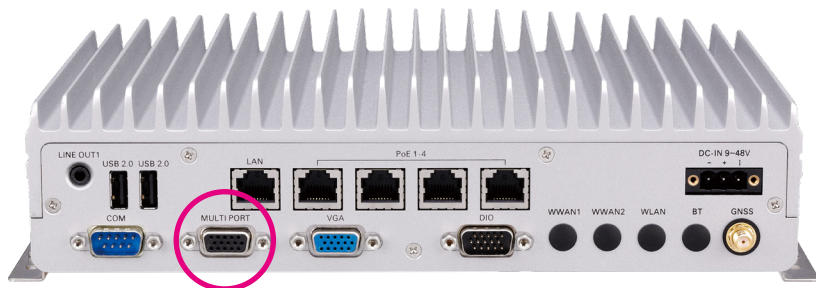

### Multi Port Cable

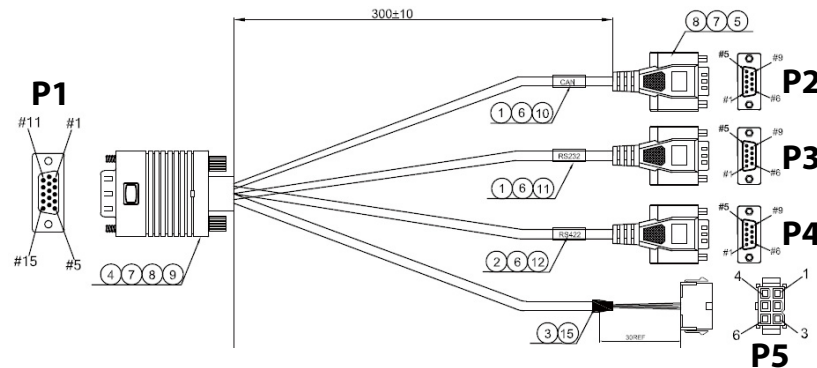

## P1 Connector Pinout

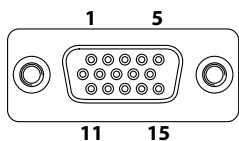

Pin	Definition	Pin	Definition
1	CAN_H	2	RS232_RX
3	RS232_TX	4	RS485_TX-
5	RS485_TX+	6	CAN_L
7	ISO_GND	8	ISO_GND
9	RS422_TX-	10	RS422_TX+
11	CAN ISO_GND	12	GND
13	GND	14	12V
15	12V		

## P2 to P5 Connector Pinouts

### CAN Connector

Connector location: P2

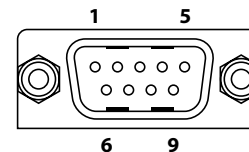

P1 Pin	P2 Pin	Definition
1	3	CAN_H
6	5	CAN_L
11	2	CAN ISO_GND

## RS232 Connector

Connector location: P3

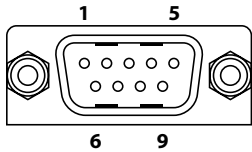

P1 Pin	P3 Pin	Definition
2	2	RS232_RX
3	3	RS232_TX
7	5	ISO_GND

## RS485/RS422 Connector

Connector location: P4

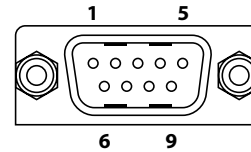

P1 Pin	P4 Pin	Definition
4	4	RS485_TX-
5	3	RS485_TX+
8	5	ISO_GND
9	1	RS422_TX-
10	2	RS422_TX+

## DC Output Connector

Connector location: P5

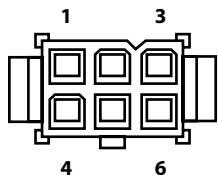

P1 Pin	P5 Pin	Definition
12	5	GND
13	5	GND
14	2	12V
15	2	12V

The DIO port consists of a 15-pin female D-sub connector and multiple output connectors. The following tables in this appendix list the pin signals of the P1 connector and its corresponding pin signals to the output connectors.

**nROK 6222 Rear View**



**VTC 6222 Rear View**

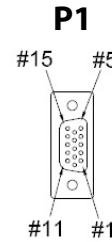
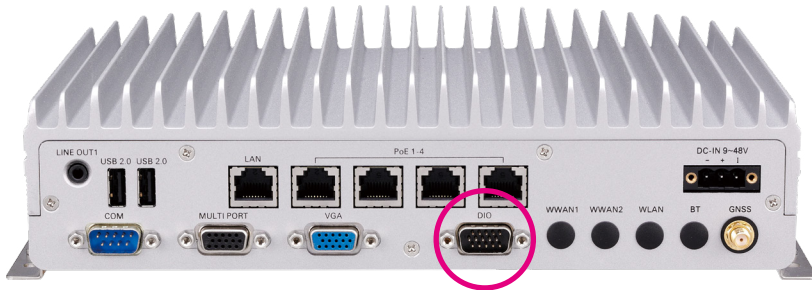

**DIO Port Cable**

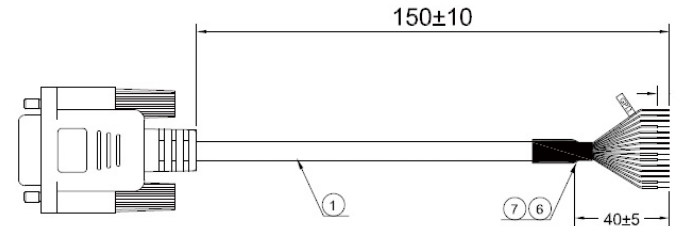

## P1 Connector Pinout

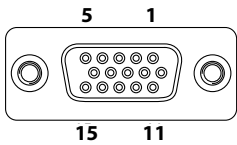

Pin	Definition	Pin	Definition
1	GPI1	2	GPI2
3	GPI3	4	GPI4
5	GPO1	6	GPO2
7	GPO3	8	GPO4
9	VIN_GPIO	10	GND



# APPENDIX F: POWER CONSUMPTION

**OS:** Windows 10

**Burn-in Software:**

**Device:**

Idle: Into OS + display x 3 + all module (unlink) + keyboard & mouse + audio

Full State: Burn-in 100% + mini PCIe dummy load + play video + keyboard & mouse + audio + COM trans + GPS link

Full State + Loading: Full state + USB load (5V/1A x 1, 5V/0.5A x 3) + DC out (12V/2A) + PoE dummy load (15W x 4)

Item	Device	Test Case		Result	
				Current(A)	Watt(W)
1	S0 State	Idle State (Display x 2 <VGA + HDMI>)	12V	1.85	22.2
			24V	0.94	22.56
			36V	0.71	25.56
			48V	0.56	25.92
		Full State	12V	2.91	34.92
			24V	1.49	35.76
			36V	1.06	38.16
			48V	0.82	39.36
		Full State + Loading	12V	6.28	75.36
			24V	3.13	75.12
			36V	2.15	77.4
			48V	1.63	78.24
		Full State + Loading (+PoE x 4)	12V	12.76	153.12
			24V	6.21	149.04
			36V	4.2	151.2
			48V	3.18	152.64

Item	Device	Test Case		Result	
				Current(A)	Watt(W)
2	S3 State	Full State Sleep Mode	12V	0.39A	4.86
			12V WWAN	0.41A	4.92
			12V WWAN PoE 60W	6.63A	79.56
3	IGN OFF	Full State IGNITION OFF	12V	6mA	0.07
			12V WWAN	6mA	0.07
			24V	8mA	0.19
			24V WWAN	8mA	0.19
			36V	10mA	0.36
			36V WWAN	10mA	0.36
			48V	14mA	0.67
48V WWAN	14mA	0.67			

\*WWAN: Enable wakeup function of WWAN module