



tGW-700-T Series Quick Start

V1.0, Oct. 2020

What's in the box?

In addition to this guide, the package includes the following items:



tGW-700-T Module x 1



Quick Start x1 (This Document)

Related Information

- tGW Series Product Page:

http://www.icpdas.com/en/product/guide+Industrial_Communication+Gateway+tGW_Modbus_Gateway#1063

- Documentation & Firmware:

<http://www.icpdas.com/en/download/index.php?nation=US&kind1=&model=&kw=tGW-700>

- NS-205/M-7000 Product Page (optional):

http://www.icpdas.com/en/product/guide+Industrial_Communication+Ethernet_Communication+Ethernet_Switch

http://www.icpdas.com/en/product/guide+Remote_I_O_Module_and_Unit+RS-485_I_O_Modules+I-7000#467

1 Connecting the Power and Host PC

1) Make sure your PC has workable network settings.

Disable or well configure your Windows firewall and Anti-Virus firewall first, else the “Search Servers” on Chapter 5 may not work. (Please contact with your system Administrator)

2) Connect both the tGW-700-T and your PC to the same sub network or the same Ethernet switch.

3) Supply power (+12~+48 V_{DC}) to the tGW-700-T.

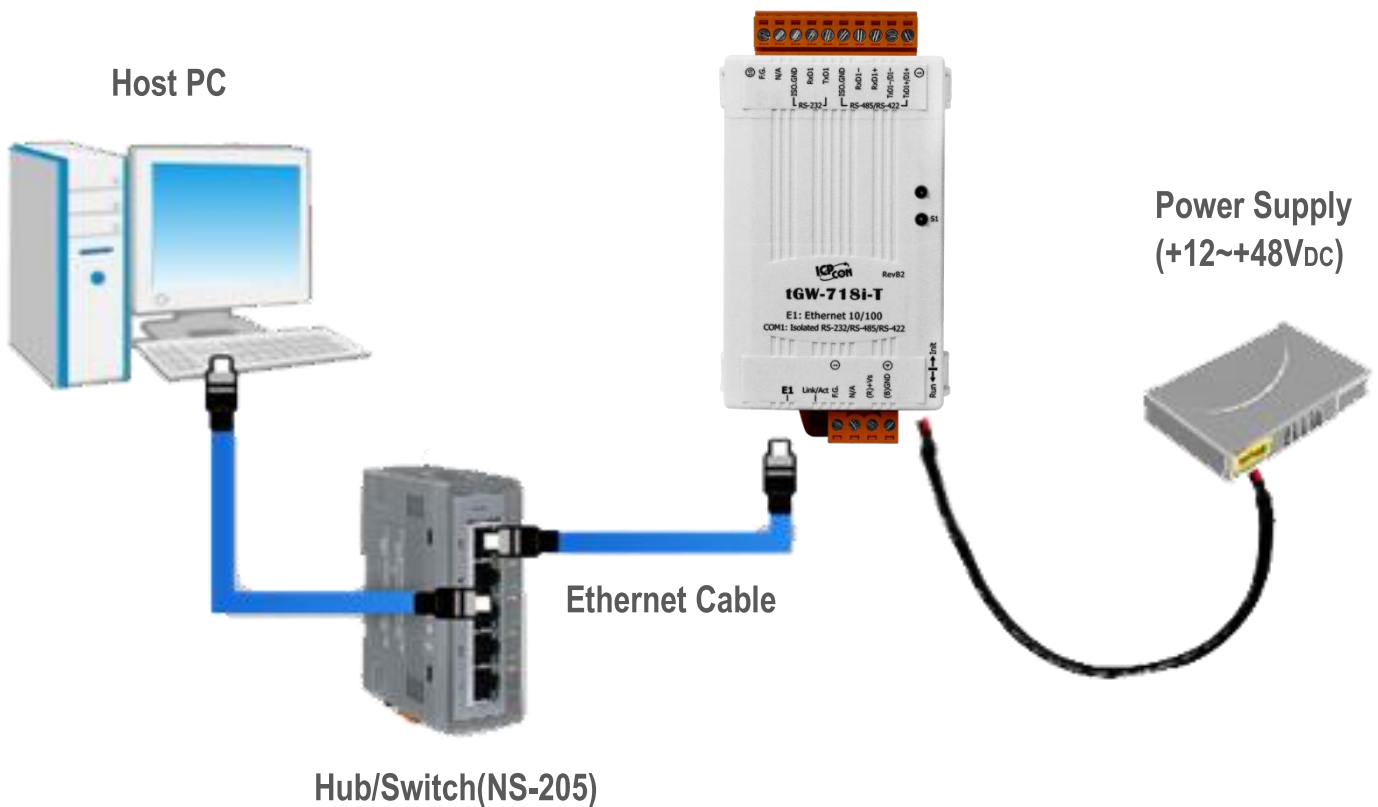

2

Installing Software on Your PC

Install eSearch Utility, which can be obtained from the website:



 http://www.icpdas.com/en/product/guide+Software+Utility_Driver+eSearch_Utility

3

Wiring Notes

Wiring Notes for RS-232/485/422 Interfaces:

: Here, the RS-232 and RS-485 wiring is used as an example.

<input checked="" type="checkbox"/> RS-232 Wiring	<input type="checkbox"/> RS-422 Wiring																								
<table border="1"> <thead> <tr> <th>tGW-700-T</th> <th>RS-232 Modbus Device</th> </tr> </thead> <tbody> <tr> <td>RxD</td> <td>TxD</td> </tr> <tr> <td>TxD</td> <td>RxD</td> </tr> <tr> <td>GND</td> <td>GND</td> </tr> <tr> <td>RTS</td> <td>CTS</td> </tr> <tr> <td>CTS</td> <td>RTS</td> </tr> </tbody> </table>	tGW-700-T	RS-232 Modbus Device	RxD	TxD	TxD	RxD	GND	GND	RTS	CTS	CTS	RTS	<table border="1"> <thead> <tr> <th>tGW-700-T</th> <th>RS-422 Modbus Device</th> </tr> </thead> <tbody> <tr> <td>TxD+</td> <td>RxD+</td> </tr> <tr> <td>TxD-</td> <td>RxD-</td> </tr> <tr> <td>RxD+</td> <td>TxD+</td> </tr> <tr> <td>RxD-</td> <td>TxD-</td> </tr> <tr> <td>GND</td> <td>GND</td> </tr> </tbody> </table>	tGW-700-T	RS-422 Modbus Device	TxD+	RxD+	TxD-	RxD-	RxD+	TxD+	RxD-	TxD-	GND	GND
tGW-700-T	RS-232 Modbus Device																								
RxD	TxD																								
TxD	RxD																								
GND	GND																								
RTS	CTS																								
CTS	RTS																								
tGW-700-T	RS-422 Modbus Device																								
TxD+	RxD+																								
TxD-	RxD-																								
RxD+	TxD+																								
RxD-	TxD-																								
GND	GND																								
<table border="1"> <thead> <tr> <th>tGW-700-T</th> <th>RS-485 Modbus Device</th> </tr> </thead> <tbody> <tr> <td>Data+</td> <td>Data+</td> </tr> <tr> <td>Data-</td> <td>Data-</td> </tr> <tr> <td>GND</td> <td>GND</td> </tr> </tbody> </table>	tGW-700-T	RS-485 Modbus Device	Data+	Data+	Data-	Data-	GND	GND																	
tGW-700-T	RS-485 Modbus Device																								
Data+	Data+																								
Data-	Data-																								
GND	GND																								

4 Connecting the Modbus Devices

- 1) Connect the Modbus device (e.g., M-7022, optional) to the COM1 on tGW-700-T.
- 2) Supply power to the Modbus device (e.g., M-7022, Device ID:1).

⚠ Note: The wiring and supply power method depends on your Modbus device.

➤ RS-485 Wiring

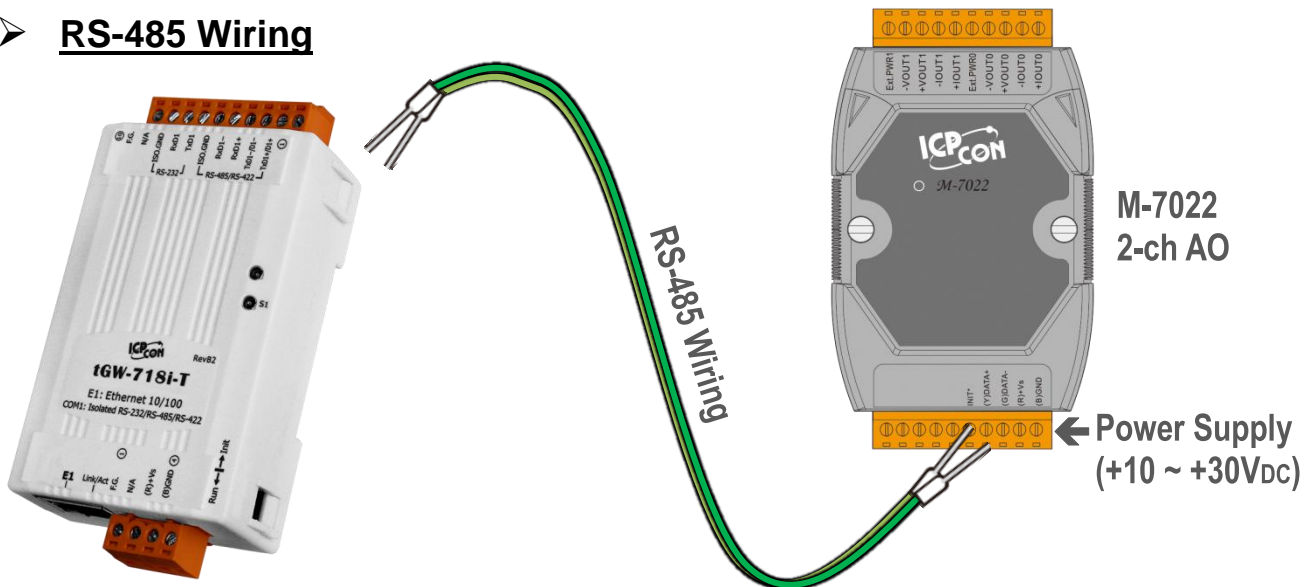

➤ RS-232 Wiring

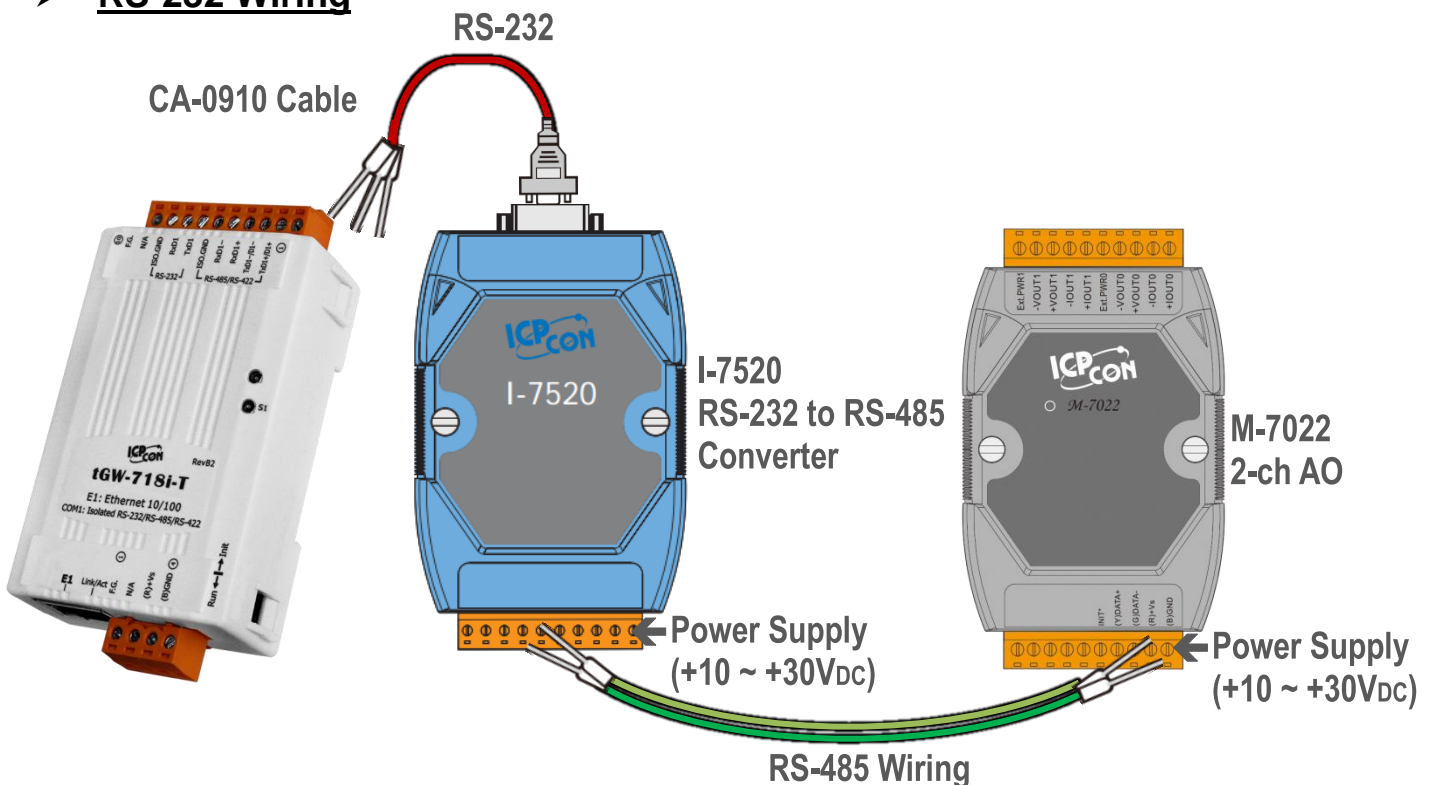

5

Configuring Network Settings

- 1) Double-click the eSearch Utility shortcut on the desktop.
- 2) Click the “**Search Servers**” to search your tGW-700-T.
- 3) Double-click the name of tGW-700-T to open the “**Configure Server (UDP)**” dialog box.

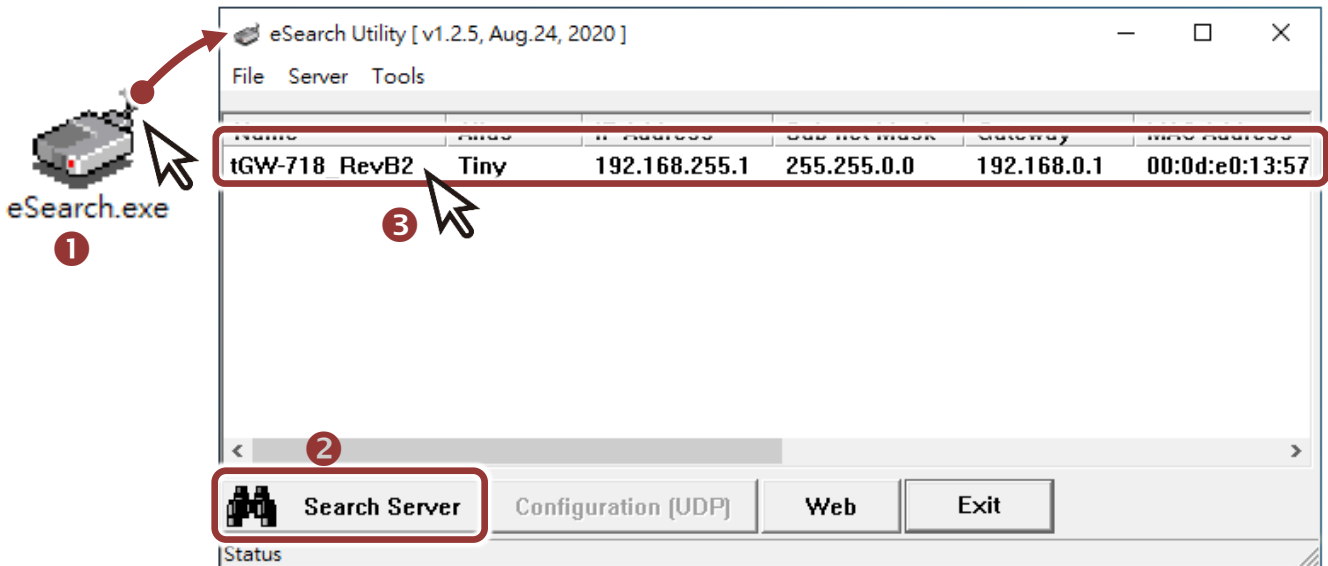

Factory Default Settings of tGW-700-T:

IP Address	192.168.255.1
Subnet Mask	255.255.0.0
Gateway	192.168.0.1

- 4) Contact your Network Administrator to obtain a correct network configuration (such as **IP/Mask/Gateway**). **Enter the network settings** and click “**OK**”. **⚠️ Note: The tGW-700-T will use the new settings 2 seconds later.**

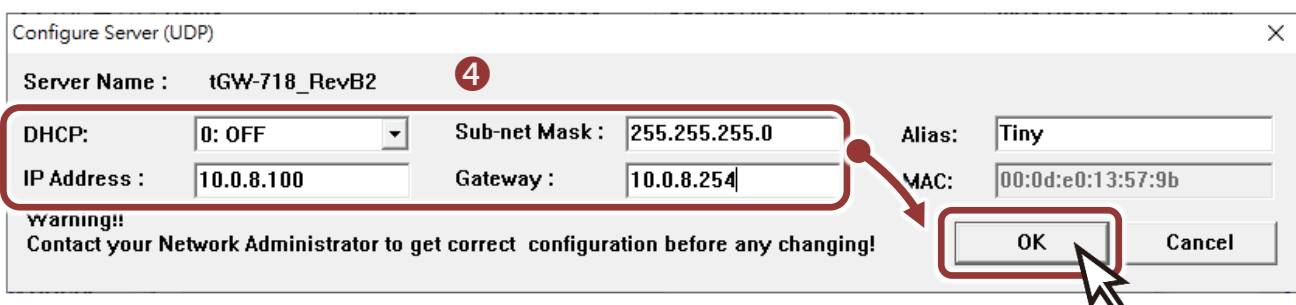

- 5) Wait 2 seconds and click “**Search Servers**” button again to ensure the tGW-700-T is working well with new configuration.
- 6) Click the name of tGW-700-T to select it.
- 7) Click the “**Web**” button to log in to the web configuration pages.
(Or enter the URL address of the tGW-700-T in the address bar of the browser.)

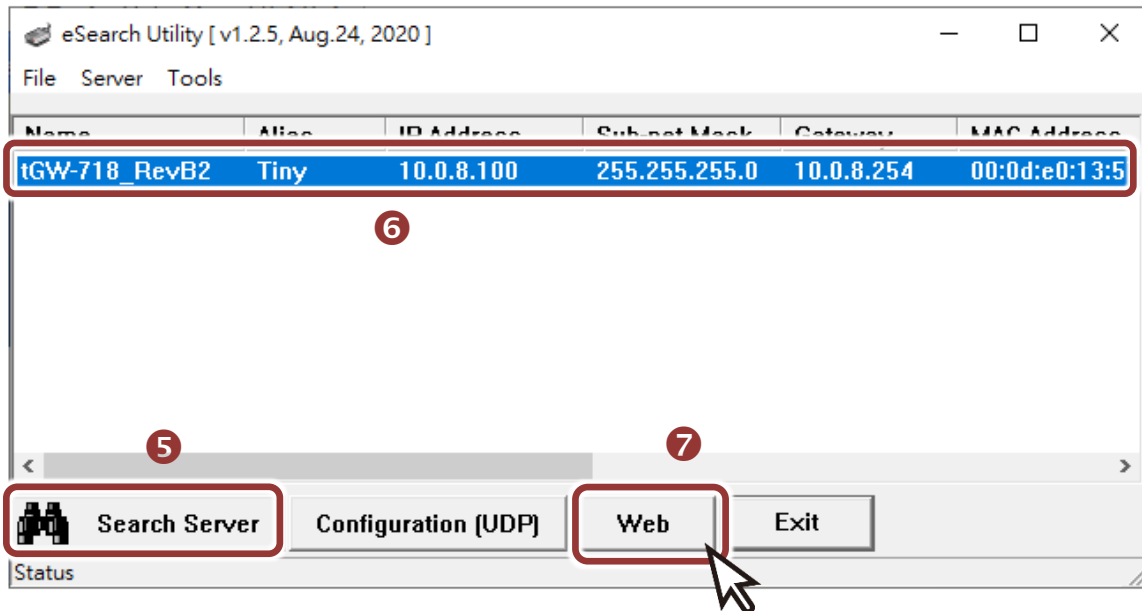

6 Configuring the Serial Port

Note that if you intend to use Internet Explorer, ensure that the cache function is disabled in order to prevent browser access errors, please disable your Internet Explorer cache as follow: **(If you are not using IE browser, please skip this step.)**

Step1: Click “**Tools**” >> “**Internet Options...**” in the menu items.

Step 2: Click “**General**” tab and click the “**Settings...**” button in Temporary Internet files frame.

Step3: Click “**Every visit to the page**” and click the “**OK**” in Settings box and Internet Options box.

1) Enter the password in the login password field and click “**Submit**”.

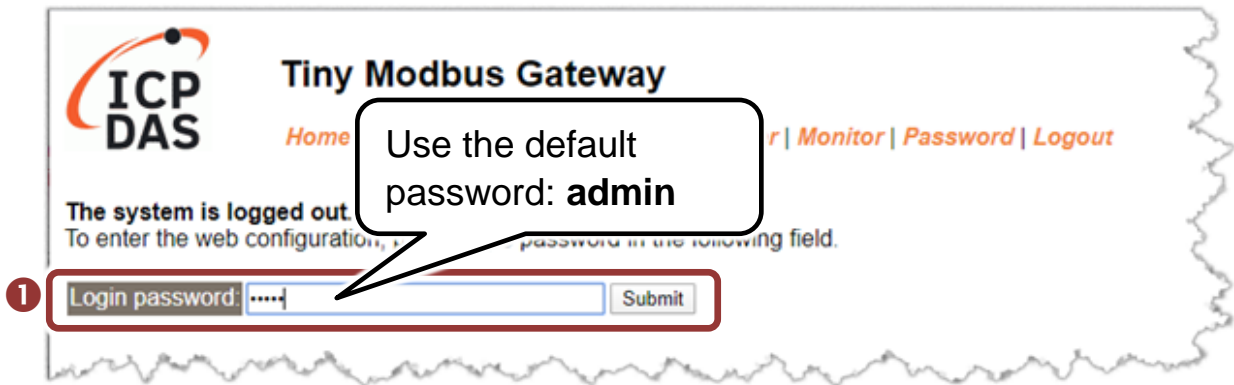

2) Click the “**Port1**” tab to display the “**Port1 Settings**” page.

3) Select the appropriate **Baud Rate, Data Format and Modbus Protocol** (e.g., 19200, 8N2 and Modbus RTU) from the relevant drop down options.

⚠ Note: The Baud Rate, Data Format and Modbus protocol settings depends on your Modbus device.

4) Click “**Submit**” to save your settings.

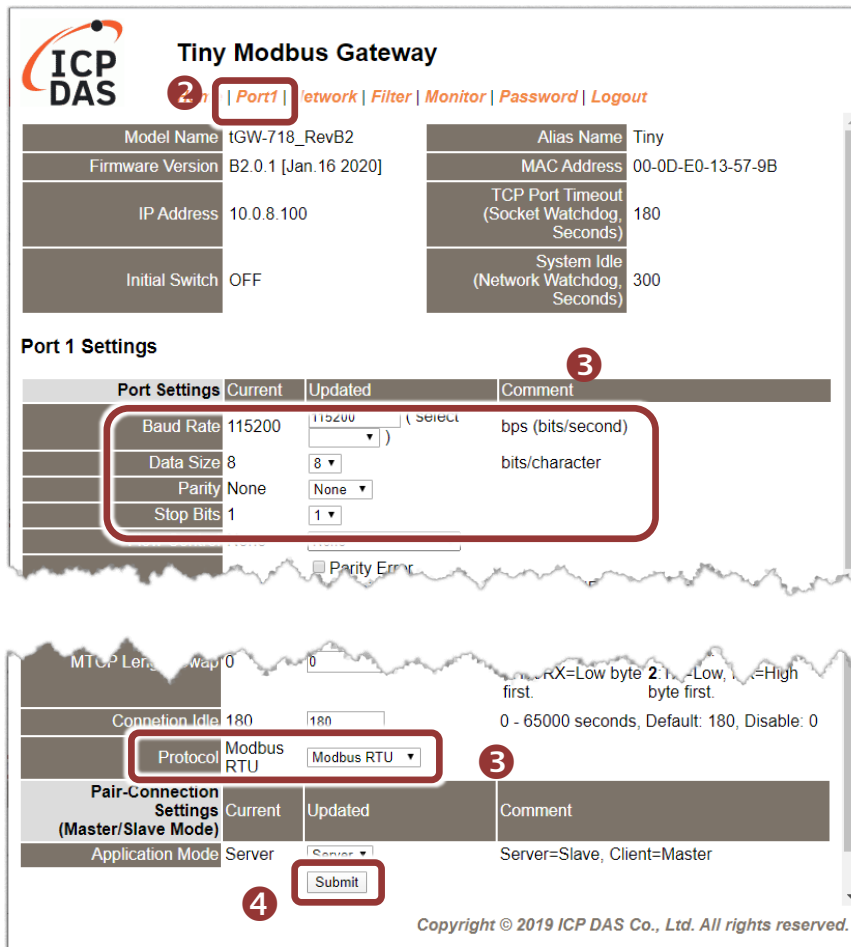

7 Self-Test

- 1) In the eSearch Utility, select the “**Modbus TCP Master**” item from the “**Tools**” menu to open the Modbus TCP Master Utility.

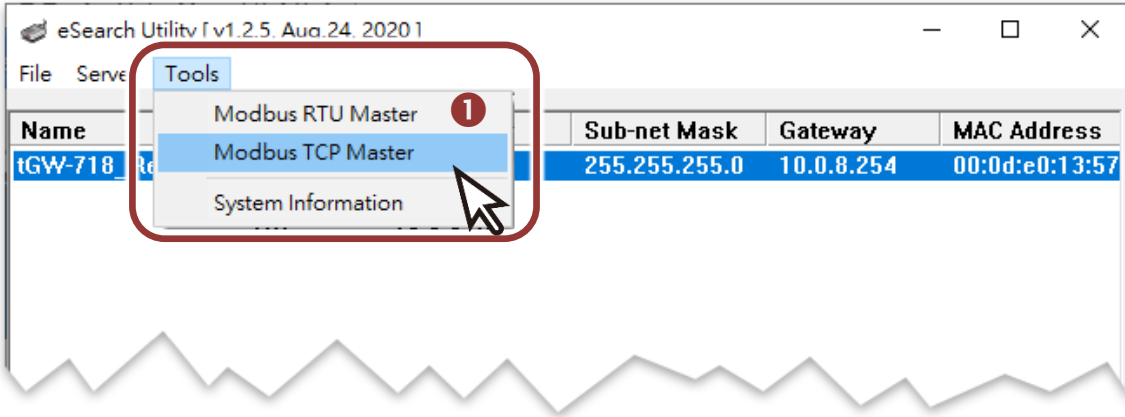

- 2) In the Modbus TCP Modbus Utility, enter the IP address of tGW-700-T and click “**Connect**” to connect the tGW-700-T.
- 3) Refer to “**Protocol Description**” section and type the Modbus command in the “Command” field then click “**Send command**”.
- 4) If the response data is correct, it means the test is success.

⚠ Note: The Modbus command settings depends on your Modbus device.

