

Quick Start

for PCIe-S112(i) PCIe-S142(i)



June 2021/ Version 1.0

1

What's in the Shipping Package?

The package includes the following items:

- 1 PCIe-S112 or PCIe-S142



- 2 Quick Start Guide (This Guide)



- 3 Software CD (V6.1 or later)



2

Installing Windows Driver

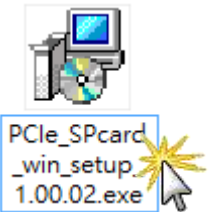

- 1 Launch the **Windows XP/7/8/10/2012/2016 (32/64-bit) driver setup program (PCIe_SPCard_Win_Setup_1.00.02.exe)**, which can be obtained from either the companion CD-ROM or the web site:



CD: \Napdos\multiport\windows\



<https://www.icpdas.com/en/download/index.php?nation=US&kw=PCIe+Series+Card+Windows+Driver>

- 2 Click the **“Next>”** button to start the installation.
- 3 Click the **“Next>”** button to install the driver into the default folder.
- 4 In the installation process, the Command Prompt windows will be displayed, don't care. And please do not close this Command Prompt window in installation process.
- 5 Select the **“NO, I will restart the computer later”** and click the **“Finish”** button.

3

Installing the Hardware

- 1 Shut down and power off your computer.
- 2 Remove the cover from the computer.
- 3 Select an unused PCI Express slot.
- 4 Carefully insert your PCIe-S1x2 card into the PCI Express slot.
- 5 Replace the PC cover.
- 6 Power on the computer.
- 7 Follow the prompt message to finish the Plug & Play steps.
- 8 Please open the “**Device Manager**” to verify the COM port installation, as follows steps:

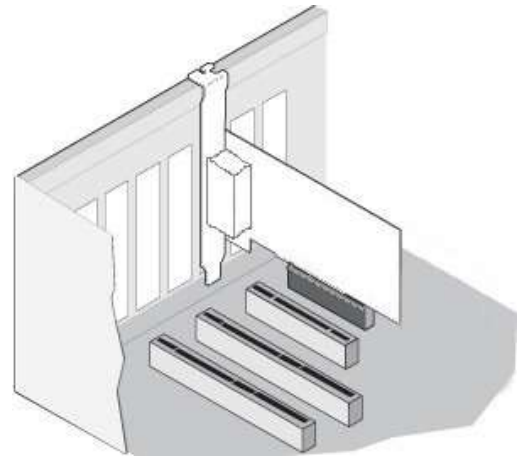

8-1: In Windows 7, Click “**Start**” button, and then click “**Control Panel**”.

8-2: Click “**System and Maintenance**”, and then click “**Device Manager**”.

8-3: Verify that the COM ports of PCIe-S112/S142 card are listed correctly.

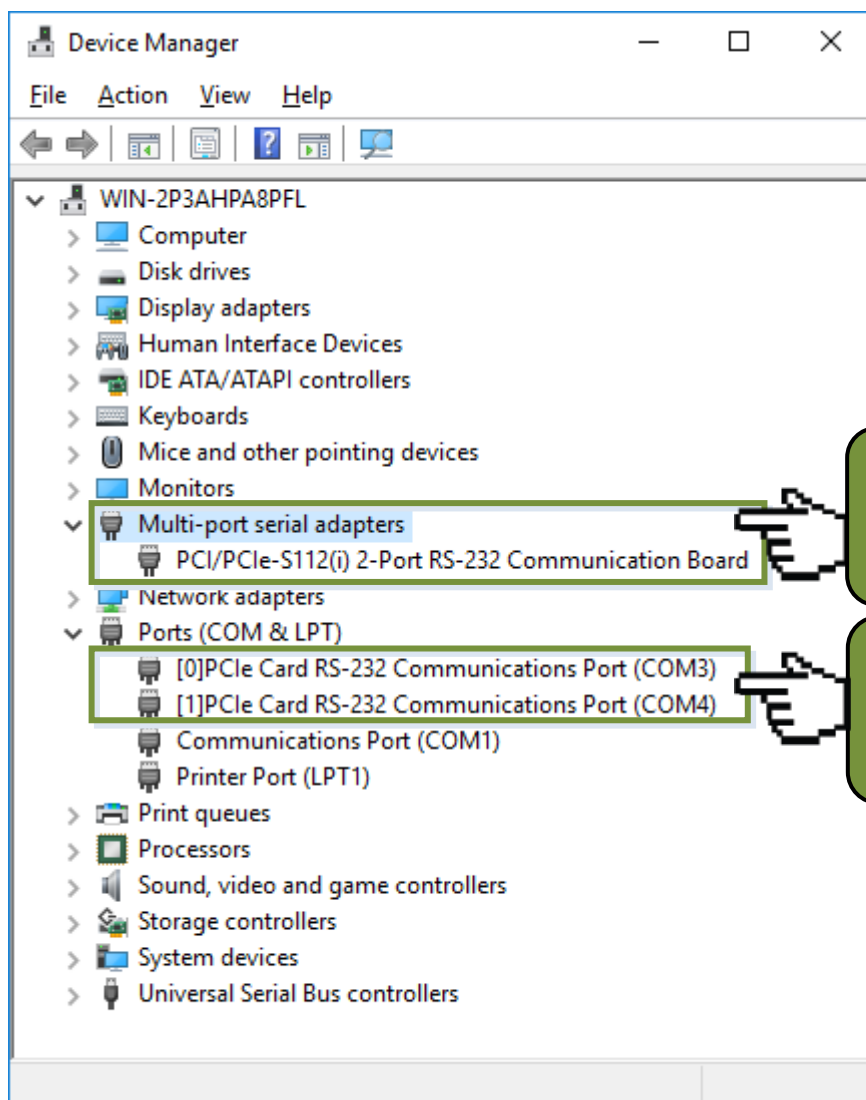

Successful Installation
Check whether the PCIe-S1x2 card is listed correctly or not.

Successful Installation
COM port mapping is automatically applied depending on the PC.

4

Manual COM Port Configuration

If the auto-configuration for COM Port is messy or that is not you need, you can change the COM port mappings. For detailed configuration steps, please refer to the following steps:

- 1 Open Windows **Device Manager** and **right click** the serial port of the PCIe-S1x2 series card.
- 2 Select the **“Properties”** item from the popup menu.
- 3 Click the **“Port Settings”** tab and click the **“Advanced...”** button.
- 4 Select the appropriate **COM Port number** from the **“COM Port Number:”** drop-down options and click the **“OK”** button. **Note that the COM port display “(in use)” means this COM port is being used. Therefore, please do not select it.**
- 5 Click the **“OK”** button in the “Properties” dialog box.
- 6 **Restart your computer** to complete the configuration.

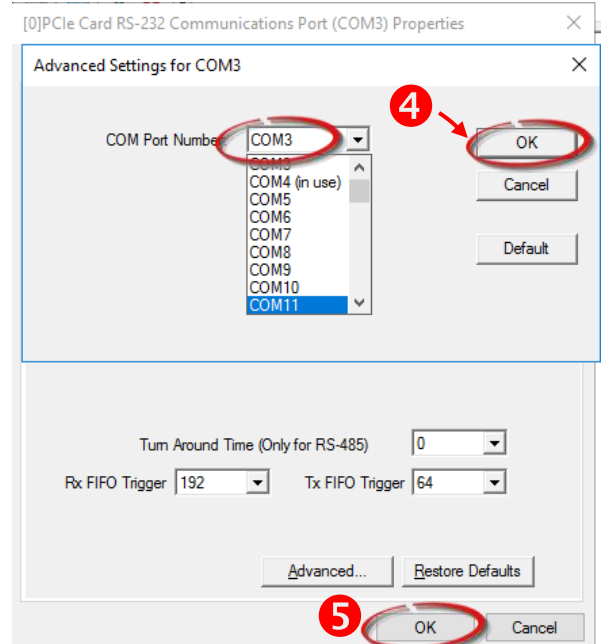
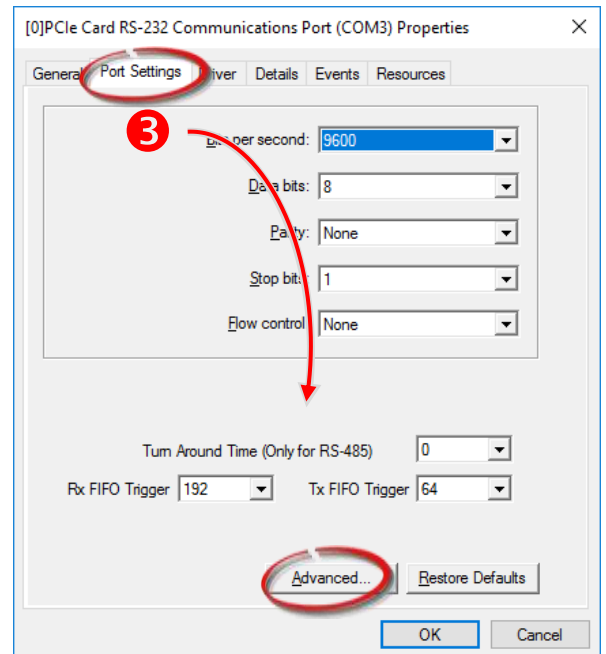
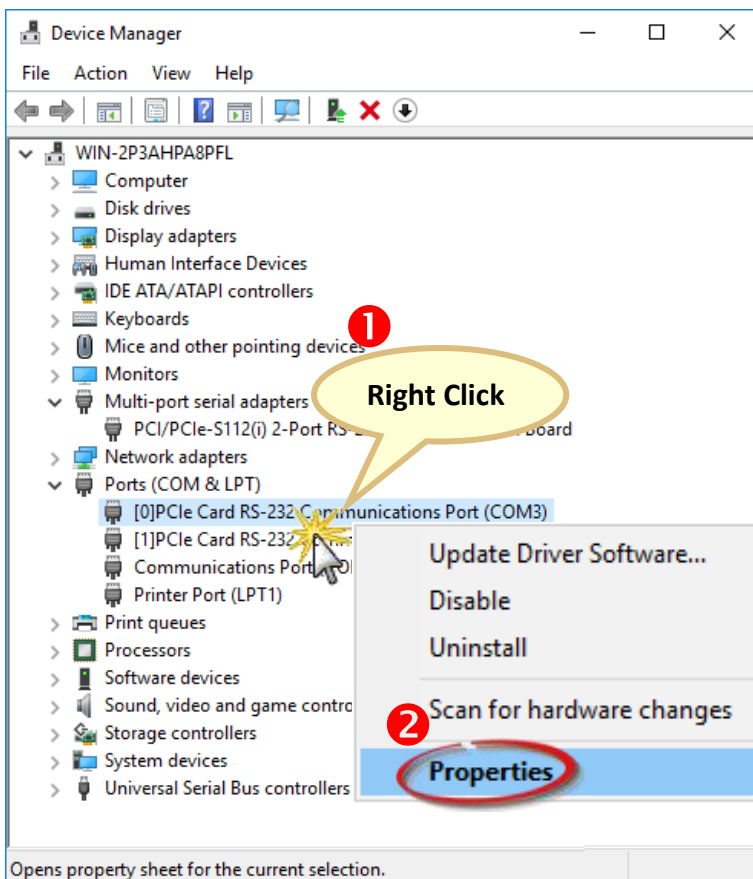

5

Pin Assignments and RS-232 Cable Wiring for PCIe-S112(i)

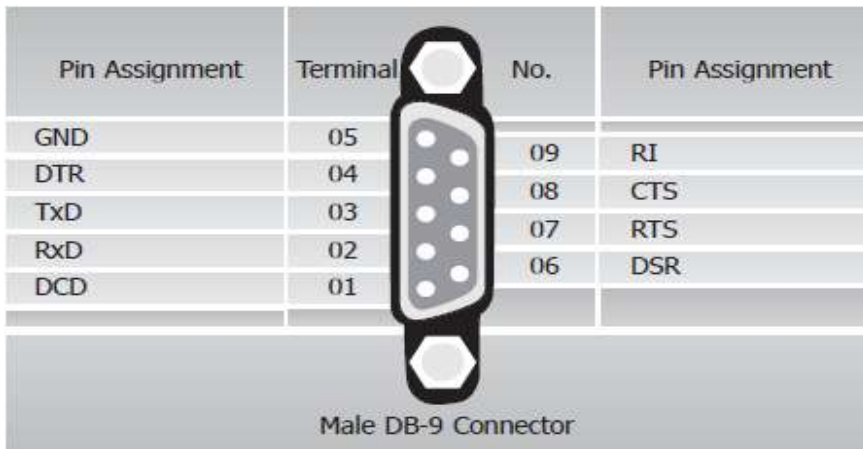

PCIe-S112 Card		RS-232 Wiring		Device
Signal	PIN		PIN	Signal
RxD	2	←	3	TxD
TxD	3	→	2	RxD
GND	5	↔	5	GND
DTR	4	→	6	DSR
--	--		1	DCD
DCD	1		--	--
DSR	6	←	4	DTR
RTS	7	→	8	CTS
CTS	8	←	7	RTS
RI	9	←	9	RI

6

Pin Assignments and RS-422/485 Cable Wiring for PCIe-S142(i)

Pin Assignment	Terminal	No.	Pin Assignment
GND/VEE	05	09	CTS-(A)
RxD-(A)	04	08	CTS+(B)
RxD+(B)	03	07	RTS+(B)
TxD+(B)/Data+(B)	02	06	RTS-(A)
TxD-(A)/Data-(A)	01		



RS-422/485 Male DB-9 Connector

PCIe-S142 Card		RS-485 Wiring		Device
Signal	PIN		PIN	Signal
DATA-	1	↔	1	DATA-
DATA+	2	↔	2	DATA+

Note: The RS-485 bus is a differential (balanced) signal, thus you cannot wire the Data+ with Data- directly for a single port loop-back test. It will not work at all.

PCIe-S142 Card		RS-422 Wiring		Device
Signal	PIN		PIN	Signal
TxD-	1	→	4	RxD-
TxD+	2	→	3	RxD+
RxD+	3	←	2	TxD+
RxD-	4	←	1	TxD-
GND	5	↔	5	GND
RTS-	6	→	9	CTS-
RTS+	7	→	8	CTS+
CTS+	8	←	7	RTS+
CTS-	9	←	6	RTS-

7

Self-Test Wiring

Step 1: Connect the DN-09-2 terminal board (optional) to the PCIe-S1x2 series card using the CA-0910F cables (optional).

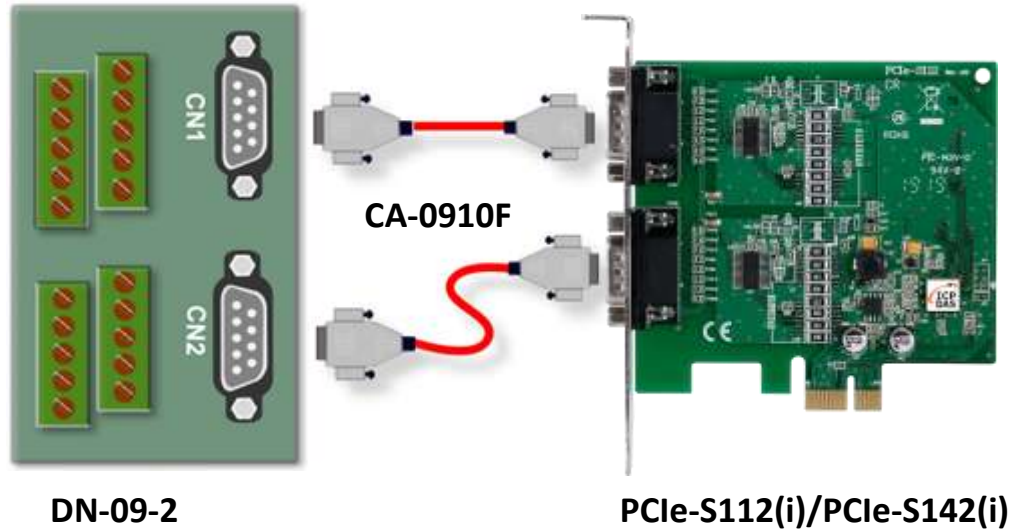

Step 2: Wire the Port 0 and Port1.

➤ **PCIe-S112(i) card (RS-232 Wiring):** Shorting the RxD, TxD and GND pins of both Port0 and Port1.

Port0 Signal	PIN		PIN	Port1 Signal
TxD0	3	↔	2	RxD1
RxD0	2	↔	3	TxD1
GND	5	↔	5	GND

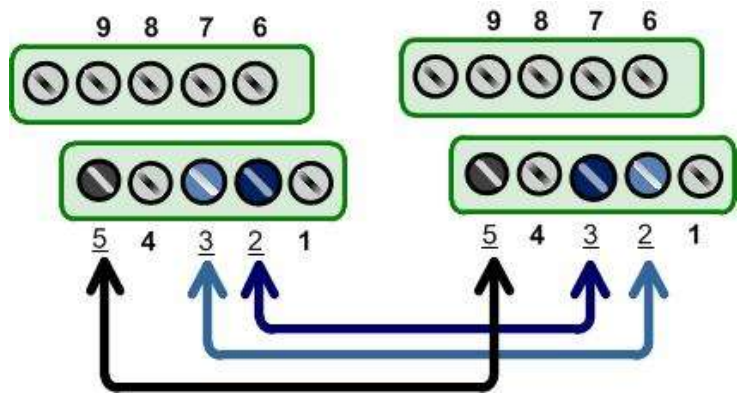

➤ **PCIe-S114(i) card (RS-485 Wiring):** Shorting the Port0 Data+ and Port1 Data+ and the Port0 Data- and Port1 Data- pins.

Port0 Signal	PIN		PIN	Port1 Signal
Data0-	1	↔	1	Data1-
Data0+	2	↔	2	Data1+

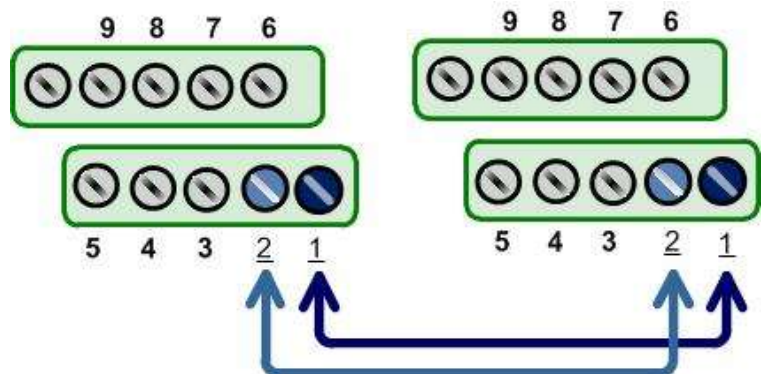

8

Execute the Test Program

Step 1: Execute the **Test2COM.exe** program, which can be downloaded from:

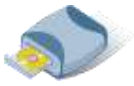

CD:\Napdos\multiport\utility



Test2COM.exe



<https://www.icpdas.com/en/download/index.php?nation=US&kw=Test2COM>

Step 2: Set the appropriate COM Ports, Baud Rate and Data Format information to the values shown in the image below.

- ❶ COM Ports: Enter **COM3** (First), **COM4** (Second).
- ❷ Data Bits: Check **"8"**
- ❸ Parity: Check **"None"**
- ❹ Stop Bits: Check **"1"**
- ❺ Baud Rates: Check values **9600 to 115200**
- ❻ Test Loops: Type **"1"**
- ❼ Click **"Start Test"** to begin the test.

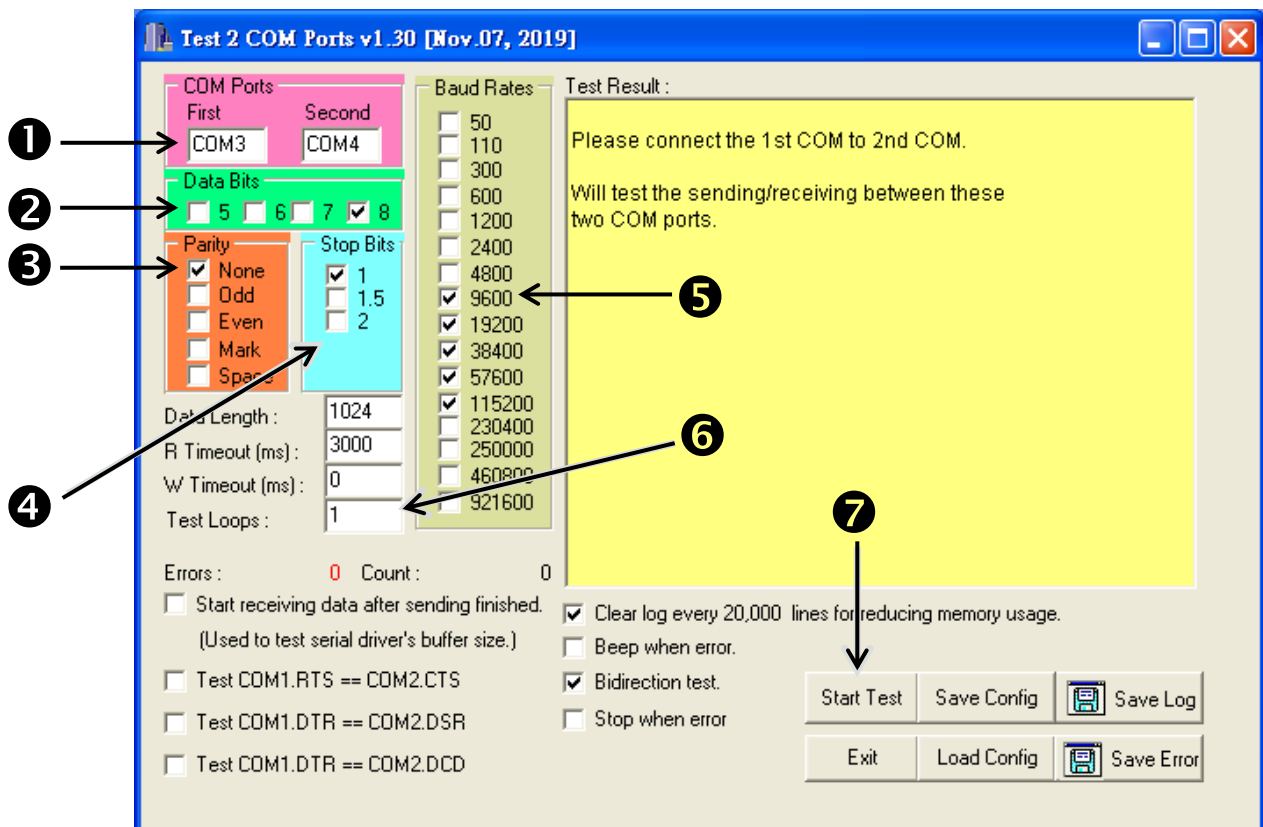

9

Successful Testing

Once the test is complete, verify the test results.

If the result indicates that the test was successful, the expanded COM Port is ready-to-use.

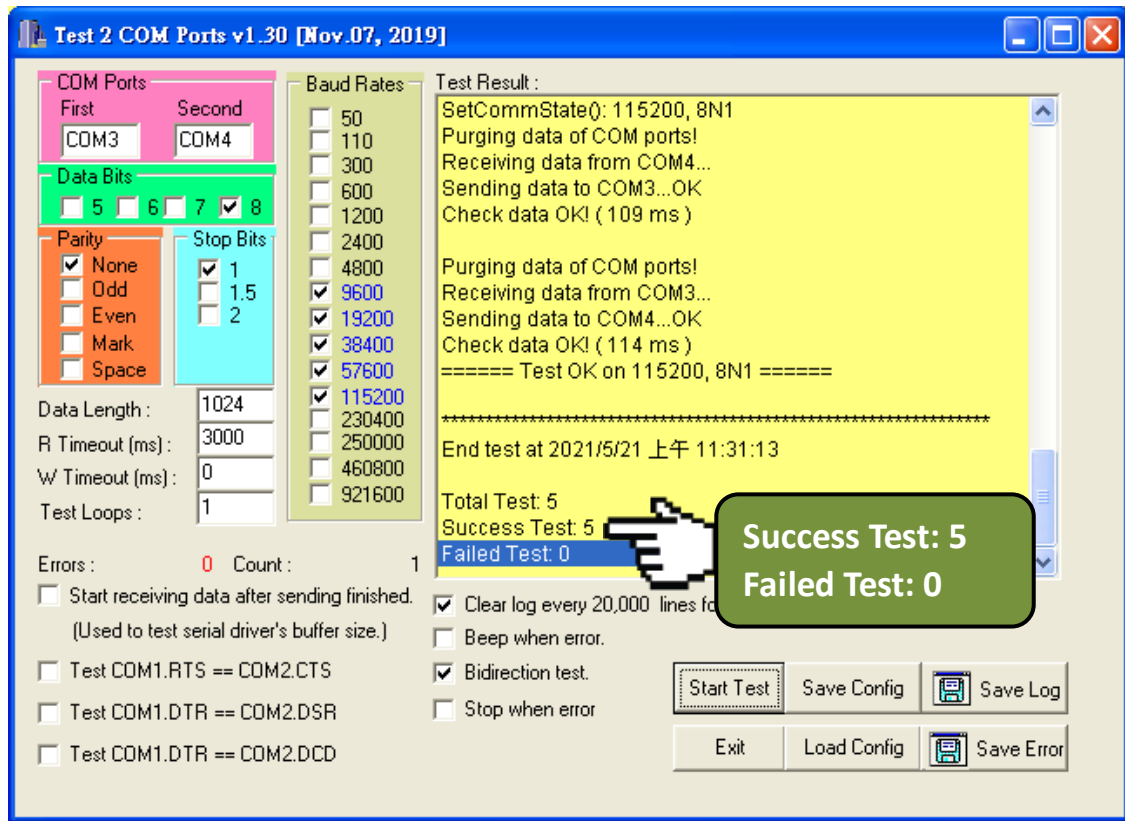

Related Information

- PCIe-S112(i)/PCIe-S142(i) card product page:
<https://www.icpdas.com/en/product/guide+Industrial+Communication+Serial+Communication+Multi-port+Serial+Board#793>
- DN-09-2 and CA-0910F product page (optional):
<https://www.icpdas.com/en/product/DN-09-2>
<https://www.icpdas.com/en/product/CA-0910F>
- Software and documentation:
CD: \Napdos\multiport\
<https://www.icpdas.com/en/download/index.php?model=PCIe-S112>