



# User's Manual

## PPC-150P

DMP Vortex86 DX2 / DX3 Processor

Compact Panel PC with 15" PCAP Touchscreen

PPC-150P-D2 Series with DX2 processor

PPC-150P-D3 Series with DX3 processor

(Revision 1.0A)

## REVISION

DATE	VERSION	DESCRIPTION
2018/8/31	Version 1.0A	New Release

ICOP TECHNOLOGY INC.

# COPYRIGHT

The information in this manual is subject to change without notice for continuous improvement in the product. All rights are reserved. The manufacturer assumes no responsibility for any inaccuracies that may be contained in this document, and makes no commitment to update or to keep current the information contained in this manual.

No part of this manual may be reproduced, copied, translated or transmitted, in whole or in part, in any form or by any means without the prior written permission of the ICOP Technology Inc.

©Copyright 2018 ICOP Technology Inc.  
Manual # IUMPPC150P-01 Ver.1.0A Aug, 2018

# TRADEMARKS ACKNOWLEDGMENT

Vortex86DX2™ and Vortex86DX3™ are the registered trademark of DMP Electronics Inc. Other brand names or product names appearing in this document are the properties and registered trademarks of their respective owners. All names mentioned herewith are served for identification purpose only.

For more detailed information or if you are interested in other ICOP products, please visit our official websites at:

- Global: [www.icop.com.tw](http://www.icop.com.tw)
- USA: [www.icoptech.com](http://www.icoptech.com)
- Japan: [www.icop.co.jp](http://www.icop.co.jp)
- Europe: [www.icoptech.eu](http://www.icoptech.eu)
- China: [www.icop.com.cn](http://www.icop.com.cn)

For technical support or demo images of operating systems download, please visit our websites at:

- ICOP Technical Resource: <http://tech.icop.com.tw/>
- Software Support: <http://www.icoptech.net/>

This Manual is for the PPC-150P.

# SAFETY INFORMATION

- Read these Safety instructions carefully.
- Please carry the unit with both hands, handle carefully.
- Make sure the voltage of the power source is correct before connecting the equipment to the power outlet.
- Do not expose your Panel PC to rain or moisture in order to prevent shock and fire hazard.
- Input voltage rated +12 ~ 24 VDC
- Operating temperature between 0~+50°C (+32~+122°F).
- Keep PPC-150P away from humidity.
- When a Compact Flash Card or a SATA Slim is the main operating system storage, please turn off power before inserting or removing. Do not open the cabinet to avoid electrical shock. Refer to your nearest dealer for qualified personnel servicing.
- Never touch un-insulated terminals or wire unless your power adaptor is disconnected.
- Locate your Panel PC as close as possible to the socket outline for easy access and to avoid force caused by entangling of your arms with surrounding cables from the Panel PC.
- USB connectors are not supplied with Limited Power Sources.
- If the equipment is not used for a long time, disconnect it from the power source to avoid damage by transient overvoltage.

## **WARNING!**



*DO NOT ATTEMPT TO OPEN OR TO DISASSEMBLE THE CHASSIS (ENCASING) OF THIS PRODUCT. PLEASE CONTACT YOUR DEALER FOR SERVICING FROM QUALIFIED TECHNICIAN.*

# Content

Content .....	iv
Ch. 1 General Information .....	1
1.1 Product Description .....	2
1.2 Product Specifications .....	3
1.3 Inspection standard for TFT-LCD Panel .....	5
1.4 Product Dimensions.....	8
1.5 Panel Mounting Instruction .....	10
1.6 Ordering Information.....	12
Ch. 2 System Installation.....	14
2.1 CPU Board Outline .....	15
2.2 Connector Summary.....	16
2.3 Connector Pin Assignments.....	17
2.4 External I/O Overview.....	19
2.5 External I/O Pin Assignment.....	20
2.6 Watchdog Timer.....	21
Ch. 3 Hardware Installation.....	22
3.1 Installing the SATA Slim .....	23
3.2 Installing the Compact Flash .....	25
Ch. 4 Driver Installation .....	26
4.1 PPC-150P Development Note .....	28
4.2 BIOS Default Setting.....	29
4.3 Serial Ports Setting (RS232/422/485) .....	30
Ch. 5 Extension I/O ( <i>Optional</i> ) .....	37
5.1 Extension I/O Overview ( <i>Optional</i> ).....	38
5.2 Extension I/O Pin Assignment ( <i>Optional</i> ).....	39
Warranty.....	40

# Ch. 1

## General Information

[1.1 Product Description](#)

[1.2 Product Specifications](#)

[1.3 Inspection standard for TFT-LCD Panel](#)

[1.4 Product Dimensions](#)

[1.5 Mounting Instruction](#)

[1.6 Ordering Information](#)

# 1.1 Product Description

ICOP Technology Inc. is proudly going to release a brand new Panel PC, which offers fanless design, low power consumption, and IP65 front panel. The PPC-150P is powered by DMP's latest Vortex86DX2 and DX3 SoCs, the 3<sup>rd</sup> generation SoCs of Vortex86 family, and dual-channel 1GB / 2GB DDRII (DDRIII) chipset that handles processing more efficiently and provides faster performance. The resistive touch panel with LED backlight TFT LCD increases operation convenience and visibility in outdoor environments. The ultra-compact and thin exterior design is perfect for the present demanding embedded and productive applications.

The new PPC-150P inherited PDX/PMX-series' smooth appearance and ultra-texture aluminum exterior design to make your industrial applications look more stylish. The versatile I/O ports, IP65 front panel, 10/100Mbps Ethernet, GIGA high-speed Ethernet etc. can fulfill fundamental functions. Our consistent advantages feature stable performance, extended working temperature support, low power consumption and fanless design. The expandable customize I/O ports can be accommodated connectivity requirements to industrial machine platforms and industrial automation equipment's needs.

The PPC-150P supports Windows Embedded CE 6.0, Windows Embedded Standard 2009, Windows Embedded Standard 7 and Linux to meet ready-to-market demand and provide competitive advantages for customers.

# 1.2 Product Specifications

## CPU BOARD SPECIFICATIONS

CPU	DM&P Vortex86DX2- 933MHz / DX3-1GHz
Cache	DX2: L1:16KB I-Cache, 16KB D-Cache L2: 256KB Cache DX3: L1:32KB I-Cache, 32KB D-Cache L2: 512KB Cache
BIOS	AMI BIOS
Memory	512MB / 1GB / 2GB DDR2(DDR3) onboard
Watchdog Timer	Software Programmable from 30.5u to 512 seconds x 2 sets
LAN	Integrated 10/100M Ethernet X1 Giga Ethernet (Optional) X1
PoE <b>(Optional)</b>	Optional upon 10/100Mbps Ethernet x 1 Support IEEE 802.3AT
Audio	HD Audio-Realtek ALC262 CODEC
Internal Drives	Compact Flash Type I / II Slot SATA SLIM SD Slot (Optional)
I/O	RS-232/422/485 x 2 USB Ports (Ver2.0) x 3 PS/2 KB Audio-Out RJ-45 Port x 1 GIGA Ethernet Port X 1 (Optional)

## MECHANICAL & ENVIRONMENT

Power Requirement	+12 ~ 24VDC
Power Consumption	+24VDC @ 1A



Operating Temperature	0~+50°C (+32~+122°F) / -20~+60°C (-4~+140°F; <b>DX2 with 800MHz</b> )
Storage Temperature	-30~+70°C (-22~ +158°F)
Operating Humidity	0% ~ 90% Relative Humidity, Non-Condensing
Dimensions	354.85x280.85x54.9mm (13.97"x11.06"x2.16")
Weight	4.00 Kg
Protection	IP65 Front Panel
Certification	CE / FCC / VCCI / Vibration/ Shock

## LCD SPECIFICATIONS

Display Type	15" XGA TFT LCD
Backlight Unit	LED
Display Resolution	1024(W) x 768(H)
Brightness (cd/m <sup>2</sup> )	250 nits
Contrast Ratio	600 : 1
Display Color	262,144
Pixel Pitch (mm)	0.297 (H) x 0.297 (V)
Viewing Angle	Vertical 160°, Horizontal 160°
Backlight Lifetime	30,000 hrs

## TOUCHSCREEN

Type	Capacitive
Hardness	≥6H
Transmittance	≥85%
Controller	USB interface
Software Driver	Linux, Win CE, Win XP, Win 7, Windows Embedded Standard
Durability	100 million

## 1.3 Inspection standard for TFT-LCD Panel

DEFECT TYPE			LIMIT				Note	
VISUAL DEFECT	INTERNAL	SPOT	$\varphi < 0.15\text{mm}$		Ignore		Note1	
			$0.15\text{mm} \leq \varphi \leq 0.5\text{mm}$		$N \leq 4$			
			$0.5\text{mm} < \varphi$		$N=0$			
		FIBER	$0.03\text{mm} < W \leq 0.1\text{mm}, L \leq 5\text{mm}$		$N \leq 3$		Note1	
			$1.0\text{mm} < W, 1.5\text{mm} < L$		$N=0$			
		POLARIZER BUBBLE	$\varphi < 0.15\text{mm}$		Ignore		Note1	
			$0.15\text{mm} \leq \varphi \leq 0.5\text{mm}$		$N \leq 2$			
			$0.5\text{mm} < \varphi$		$N=0$			
		Mura	It' OK if mura is slight visible through 6%ND filter					
		ELECTRICAL DEFECT	BRIGHT DOT	A Grade			B Grade	
C Area	O Area			Total	C Area	O Area	Total	Note3
$N \leq 0$	$N \leq 2$			$N \leq 2$	$N \leq 2$	$N \leq 3$	$N \leq 5$	Note2
DARK DOT	$N \leq 2$		$N \leq 3$	$N \leq 3$	$N \leq 3$	$N \leq 5$	$N \leq 8$	
TOTAL DOT	$N \leq 4$			$N \leq 5$	$N \leq 6$	$N \leq 8$	Note2	
TWO ADJACENT DOT	$N \leq 0$		$N \leq 1$ pair	$N \leq 1$ pair	$N \leq 1$ pair	$N \leq 1$ pair	$N \leq 1$ pair	Note4
THREE OR MORE ADJACENT DOT	NOT ALLOWED							
LINE DEFECT	NOT ALLOWED							

(1) One pixel consists of 3 sub-pixels, including R, G, and B dot. (Sub-pixel = Dot)

(2) Little bright Dot acceptable under 6% ND-Filter.

**(3) If require G0 grand (Total dot  $N \leq 0$ ), please contact region sales.**

**[ Note 1 ]** W: Width[mm]; L: Length[mm]; N: Number;  $\varphi$ : Average Diameter.

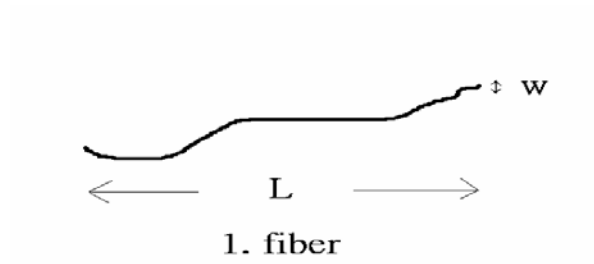
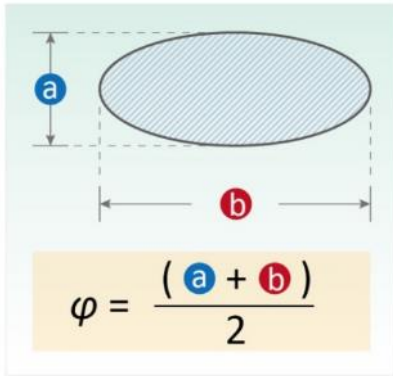

(a) White / Black Spot (b) Polarizer Bubble

[ Note 2 ] Bright dot is defined through 6% transmission ND Filter as following.

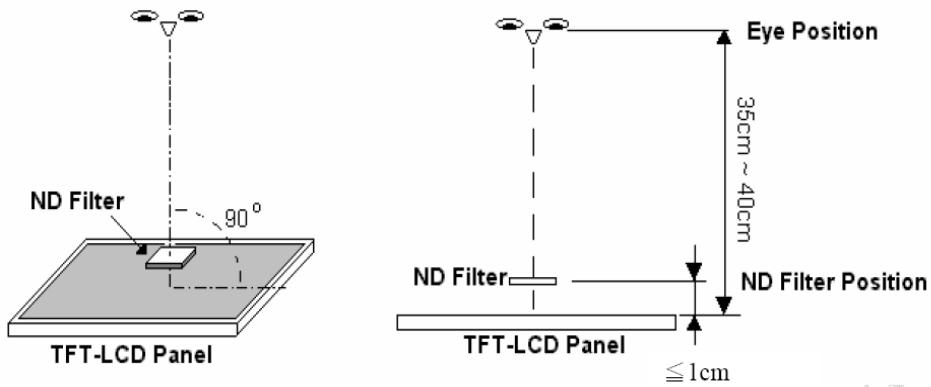

[ Note 3 ] Display area

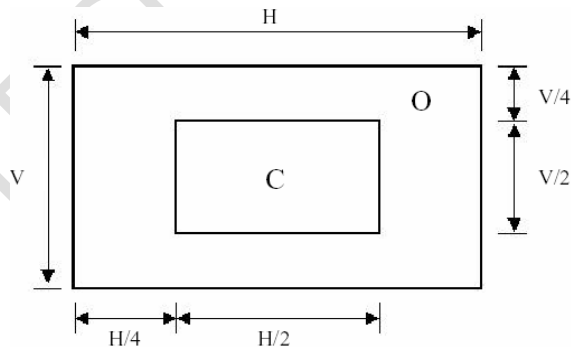

**C Area:** Center of display area    **O Area:** Outer of display area

[ Note 4 ] Judge the defect dot and the adjacent dot as following. Allow below (as A, B, C and D status) adjacent defect dots, including bright and dark adjacent dot. And they will be counted 2 defect dots in total quantity.

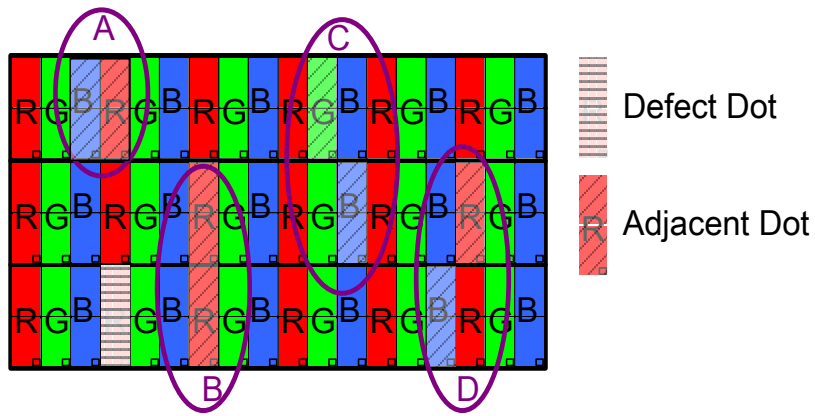

The defects that are not defined above and considered to be problem shall be reviewed and discussed by both parties.

Defects on the Black Matrix, out of Display area, are not considered as a defect or counted.

ICOP TECHNOLOGY INC.

# 1.4 Product Dimensions

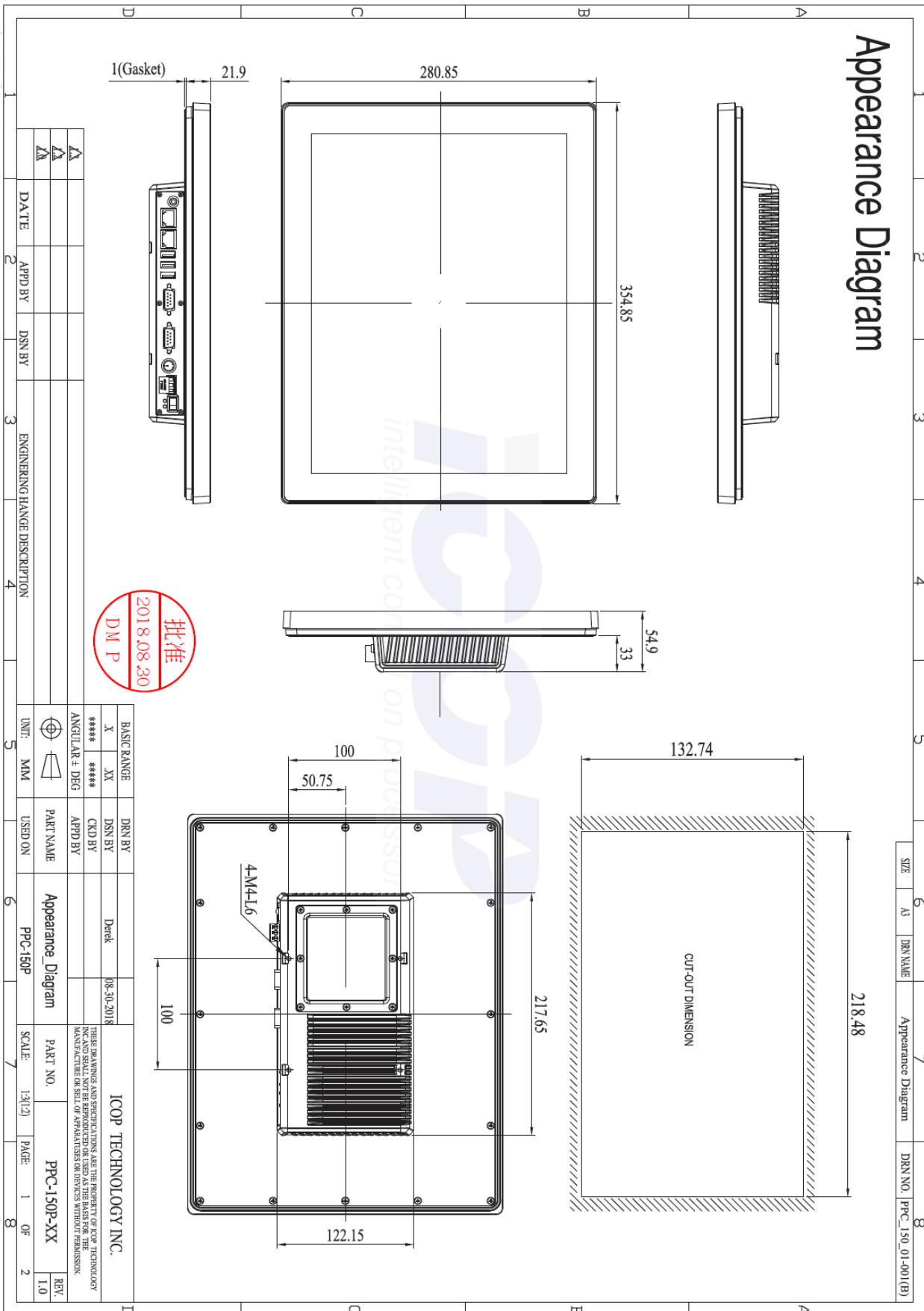

# Appearance Diagram

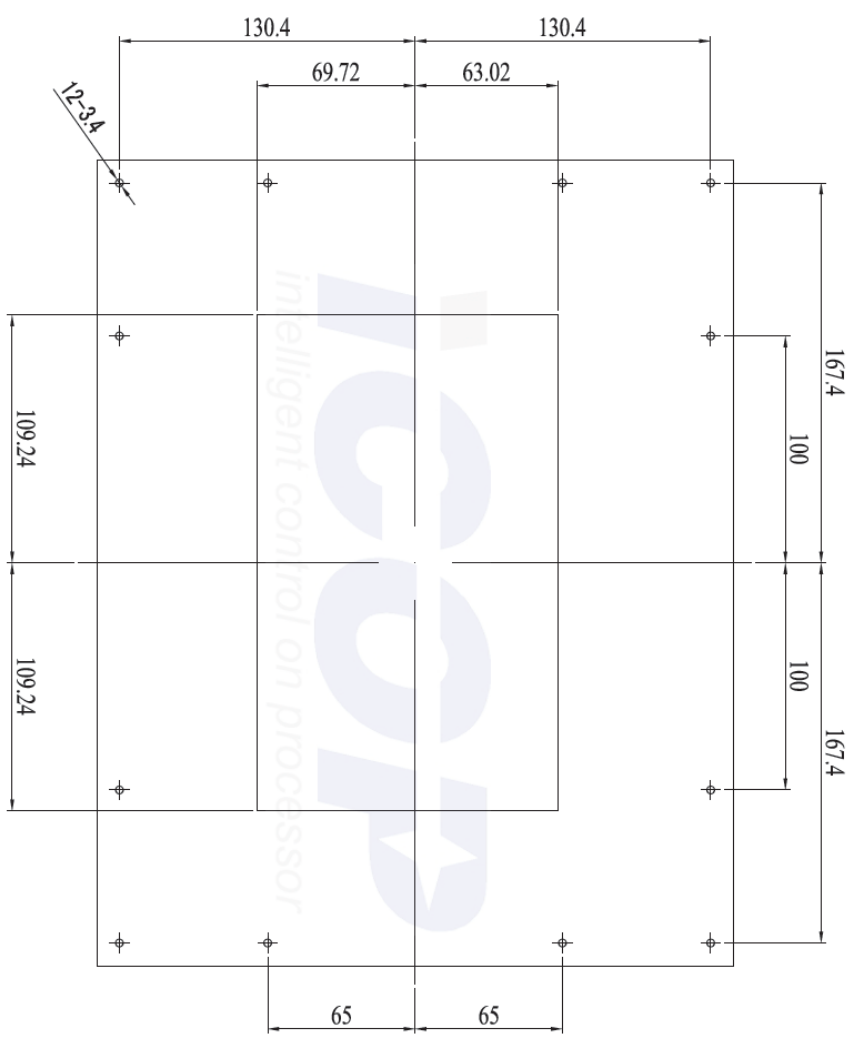

SIZE	A3	DRAWN NAME	Appearance Diagram	DRN NO.	PPC-150P-01-001(13)
------	----	------------	--------------------	---------	---------------------



BASIC RANGE	X	XX	DRN BY	Derek	08-30-2018	<b>ICOP TECHNOLOGY INC.</b> <small>THESE DRAWINGS AND SPECIFICATIONS ARE THE PROPERTY OF ICOP TECHNOLOGY INC. AND ARE NOT TO BE REPRODUCED OR USED IN ANY MANNER WITHOUT PERMISSION. ANY INFRINGEMENT WILL BE PROSECUTED TO THE FULL EXTENT OF THE LAW.</small>
ANGULAR ± DEG	****	****	CRD BY			
			APRD BY			
			PART NAME	Appearance Diagram	PART NO.	
UNIT:	MM		USED ON	PPC-150P	SCALE:	1:1(2)
					PAGE:	2 OF 2
					REV.	1.0

## 1.5 Panel Mounting Instruction

1. Cut a mounting hole in the panel. (Refer to PPC-150P Dimensions on page 11~12.) (Note 1)
2. Check and remove the twelve M3 screws in a diagonal pattern as image below if necessary.
3. Place PPC-150P face-down on a clean, flat surface.
4. Slide the panel cutout around the back of PPC-150P, until the panel rests directly on the gasket. Make sure the screw holes align with the screw holes on PPC-150P.
5. The screw size is M3\*L (L=wall thickness + 6.0mm) (Note 2)
6. Insert all twelve M3 screws into the screw holes. (Note 2)
7. Finger-tighten the M3 screws. Finish tightening the M3 screws in a diagonal pattern using an M3 screw driver (see the image as below); maximum torque 0.44Nm (4.5 kgf-cm).

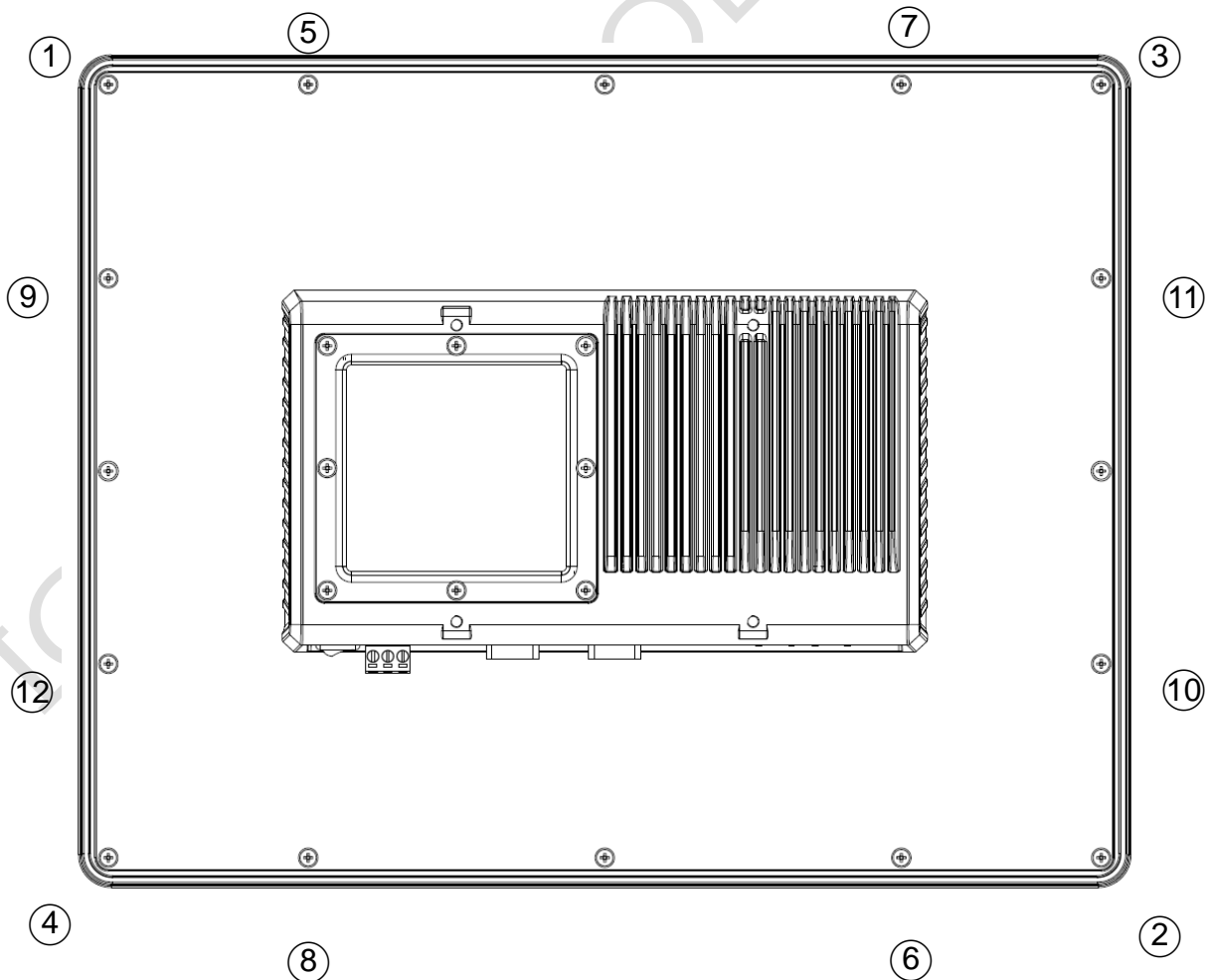

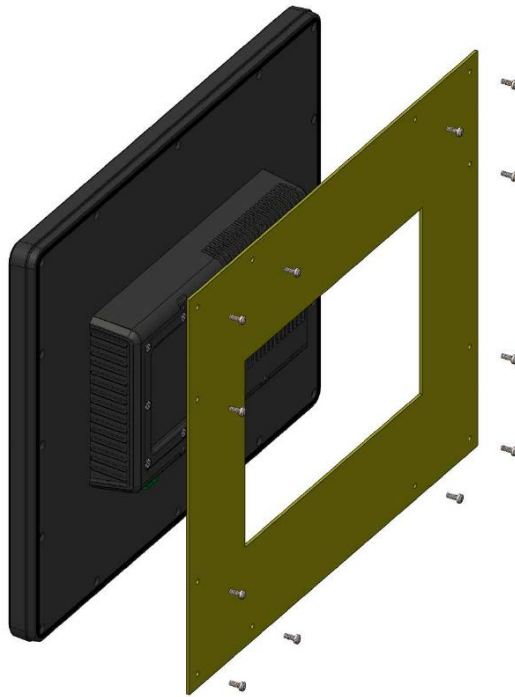

**Note 1:**

It is strongly recommended that a professional machine shop cut the mounting hole in the panel.



**Note 2:**

The length for all twelve M3 screws will be according to the thickness of mounting panel. For example: The length of standard M3 screws for PPC-150P is 6mm. If the thickness of your mounting panel is 3mm and washer thickness is 1mm, you have to use 10mm M3 screw.



# 1.6 Ordering Information

Product Code	LCD Size	CPU Type	CPU Clock	RAM	Flash onboard	I/O
PPC	090T 104T 150T 150P	D2 (DX2) D3 (DX3)	W(800MH) N(933MHz) G (1GHz) D (1GHz with wide temp.)	3(512B) 4 (1GB) 5 (2GB)	N (No Flash) A (256MB) B (512MB) C (1GB) D (2GB) E (4GB)	GE (GigaLAN) G7C (GigaLAN + 7 COMs) G7CP (GigaLAN + 7 COMs + PoE) G5CG (GigaLAN + 5 COMs + 16bit GPIO) G5CGP (GigaLAN + 5 COMs + 16bit GPIO + PoE) 7C (7 COMs) 7CP (7 COMs + PoE) 5CG (5 COMs + 16bit GPIO) 5CGP (5 COMs + 16bit GPIO + PoE)

1. Product Code : Code 1~3 ◦

PPC : Panel PC Series ◦

2. LCD Size : Code 4~7 ◦

090T : 9" LCD with Resistive touchscreen ◦

104T : 10.4" LCD with Resistive touchscreen ◦

150T : 15" LCD with Resistive touchscreen ◦

150P : 15" LCD with PCAP touchscreen ◦

3. CPU Type : Code 8~9 ◦

D2 : Vortex86DX2 CPU ◦

D3 : Vortex86DX3 CPU ◦

4. CPU Clock : Code 10 ◦

3 : 300MHz ◦      8 : 800MHz ◦      W : 800MHz ◦      N : 933M

G : 1GHz ◦      D : 1GHz with wide temp -20~60°C ◦ (DX3 only)

5. RAM : Code 11 ◦

3 : 512MB ◦      4 : 1GB ◦      5 : 2GB ◦

6. Flash Onboard : Code 12 ◦

N : No Flash ◦      A : 256MB ◦      B : 512MB ◦      C : 1GB ◦      D : 2GB ◦

E : 4GB ◦

7. I/O Code : Code 13~16 ◦

GE or G : Giga Ethernet ◦

5C : Total 5 COM ports ◦ (Standard 2 COMs + Extension board -> 3 COMs)

7C : Total 7 COM ports ◦ (Standard 2 COMs + Extension board -> 5 COMs)

G : 16bit of GPIO port ◦ (Extension board -> 16bit of GPIO)

P : PoE Function ◦ (Extension board -> PoE)

PART NUMBER	DESCRIPTION
PPC-150 <b>P</b> -D2N4N	15" Panel PC w/DX2/1GB Memory/PCAP Touch/ 3USB/AUDIO/LAN/2COM/DC12~24V
PPC-150 <b>P</b> -D2N4N-GE	15" Panel PC w/DX2/1GB Memory/PCAP Touch/ 3USB/AUDIO/LAN/GIGA LAN/2COM/ DC12~24V
PPC-150 <b>P</b> -D2N4N-G7CP	15" Panel PC w/DX2/1GB Memory/PCAP Touch/ 3USB/AUDIO/LAN/GIGA LAN/7COM/PoE
PPC-150 <b>P</b> -D2 <b>W</b> 4N-GE	15" Panel PC w/DX2- <b>800MHz</b> /1GB Memory/ PCAP Touch/3USB/AUDIO/LAN/GIGA/LAN/2COM/ DC12~24V/ <b>Wide Temp</b>
PPC-150 <b>P</b> -D3G4N	15" Panel PC w/DX3/1GB Memory/PCAP Touch/ 3USB/AUDIO/LAN/2COM/DC12~24V
PPC-150 <b>P</b> -D3G4N-GE	15" Panel PC w/DX3/1GB Memory/PCAP Touch/ 3USB/AUDIO/LAN/GIGA LAN/2COM/DC12~24V
PPC-150 <b>P</b> -D3G5N	15" Panel PC w/DX3/2GB Memory/PCAP Touch/ 3USB/AUDIO/LAN/2COM/DC12~24V
PPC-150 <b>P</b> -D3G5N-GE	15" Panel PC w/DX3/2GB Memory/PCAP Touch/ 3USB/AUDIO/LAN/GIGA LAN/2COM/DC12~24V
PPC-150 <b>P</b> -D3G5N-G7C	15" Panel PC w/DX3/2GB Memory/PCAP Touch/ 3USB/AUDIO/LAN/GIGA LAN/7COM/DC12~24V

★ Please contact your region sales for more ordering part numbers.

# Ch. 2

## System Installation

[2.1 CPU Board Outline](#)

[2.2 Connector Summary](#)

[2.3 Connector Pin Assignments](#)

[2.4 External I/O Overview](#)

[2.5 External I/O Pin Assignment](#)

[2.6 Watchdog Timer](#)

ICOP TECHNOLOGY INC.

## 2.1 CPU Board Outline

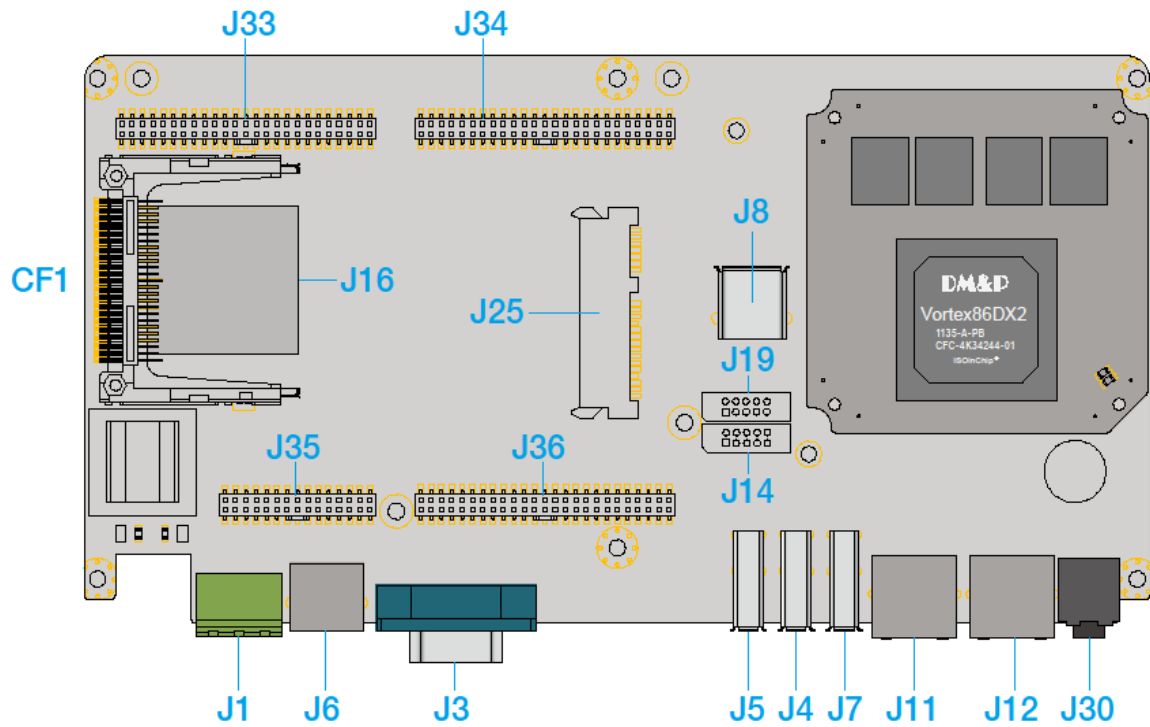

PPC CPU Board

## 2.2 Connector Summary

No.	Description	Type of Connections	Pin #
J1	Power Terminal Connector	External Power Plug	3-pin
J3	<b>COM1</b> (RS232/422/485)	External D-Sub Male Connector	9-pin
J4	USB	External USB Connector	6-pin
J5	USB	External USB Connector	6-pin
J6	PS/2Keyboard	External Mini DIN Socket	6-pin
J7	USB	External USB Connector	6-pin
J8	<b>Removed &amp; no function</b>	<b>N/C</b>	<b>N/C</b>
J11	Ethernet	External RJ45 Connector	8-pin
J12	GIGA Ethernet	External RJ45 Connector	8-pin
J14	<b>COM2</b> (RS232/422/485)	2.0mm 10-pin box header	10-pin
J16	SD Card Slot <b>(Optional)</b>	Internal SD Card Socket	
J19	VGA <b>(Reserved)</b>	2.0mm 10-pin box header	10-pin
J25	SATA Slim Slot	Internal SATA Slim Socket	
J30	Audio Line-Out	1.25mm Phone Jack	2-pin
J33	GPIO-X3 <b>(Optional)</b>	PH2*25F(2.0)-7.5mm/P2N71-2XX	50-pin
J34	GPIO-X1 <b>(Optional)</b>	PH2*25F(2.0)-7.5mm/P2N71-2XX	50-pin
J35	GPIO-X4 <b>(Optional)</b>	PH2*15F(2.0)-7.5mm/P2N71-2XX	30-pin
J36	GPIO-X2 <b>(Optional)</b>	PH2*25F(2.0)-7.5mm/P2N71-2XX	50-pin
CF1	CF Card Socket	CF Type I/II Socket	

## 2.3 Connector Pin Assignments

### J1: Power Terminal Connector

Pin #	Signal Name
1	+12~24V
2	GND
3	FG

### J3 & J14: COM1 & 2 (RS232/422/485)

Pin #	Signal Name	Pin #	Signal Name
1	DCD1/422TX-/ RS485-	2	RXD1/422TX+ /RS485+
3	TXD1/422RX+	4	DTR1/422RX-
5	GND	6	DSR1
7	RTS1	8	CTS1
9	RI1		

### J4: USB

Pin #	Signal Name	Pin #	Signal Name
1	VCC	2	USBD2-
3	USBD2+	4	GND
5	GND	6	GND

### J5: USB

Pin #	Signal Name	Pin #	Signal Name
1	VCC	2	USBD3-
3	USBD3+	4	GND
5	GND	6	GND

### J7: USB

Pin #	Signal Name	Pin #	Signal Name
1	VCC	2	USBD4-
3	USBD4+	4	GND
5	GND	6	GND

### J8: N/C

### J6 : PS/2Keyboard

Pin #	Signal Name	Pin #	Signal Name
1	KBCLK	2	MSCLK
3	GND	4	KBDATA
5	MSDATA	6	VCC
7	GND	8	GND
9	GND		

### J19: VGA (Reserved)

Pin #	Signal Name	Pin #	Signal Name
1	R OUT	2	GND
3	G OUT	4	GND
5	B OUT	6	GND
7	HSYNC	8	GND
9	VSYNCD	10	GND

**J33/J34/J35/J36: GPIO 180-pin (Optional for I/O extension board on Ch.5)**

J33				J34				J35				J36			
Pin#	Signal Name	Pin#	Signal Name	Pin#	Signal Name	Pin#	Signal Name	Pin#	Signal Name	Pin#	Signal Name	Pin#	Signal Name	Pin#	Signal Name
1	GND	2	GND	1	GND	2	SBHE	1	VCC	2	VCC	1	SA7	2	SA6
3	GP34	4	GP35	3	RSTDRV	4	SD7	3	GND	4	GND	3	IRQ3	4	SA5
5	GP36	6	GP37	5	VCC	6	SD6	5	GP90	6	GP91	5	IRQ10	6	SA4
7	GP40	8	GP41	7	SD8	8	SD5	7	GP92	8	GP93	7	IRQ11	8	SA3
9	GP42	10	GP43	9	SD9	10	SD4	9	GP94	10	GP95	9	IRQ12	10	SA2
11	GP44	12	GP45	11	SD10	12	SD3	11	GP96	12	GP97	11	BALE	12	SA1
13	GP46	14	GP47	13	SD11	14	SD2	13	GPCS0	14	GPCS1	13	OSC	14	SA0
15	GP50	16	GP51	15	SD12	16	SD1	15	GP00	16	GP01	15	GND	16	IQ14
17	GP52	18	GP53	17	SD13	18	SD0	17	GP02	18	GP03	17	GP10	18	GND
19	GP54	20	GP55	19	GND	20	GND	19	GP04	20	GP05	19	GP12	20	GP11
21	GP56	22	GP57	21	SMEMW	22	IOCHRDY	21	GP06	22	GP07	21	GP14	22	GP13
23	GND	24	GND	23	SMEMR	24	AEN	23	RS485+1	24	RS485-1	23	GP16	24	GP15
25	GP60	26	GP61	25	IOW	26	SA19	25	VBATT	26	FGND	25	GP20	26	GP17
27	GP62	28	GP63	27	IOR	28	SA18	27	VIN	28	VIN-	27	GP22	28	GP21
29	GP64	30	GP65	29	SD14	30	SA17	29	VIN	30	VIN-	29	GP24	30	GP23
31	GP66	32	GP67	31	SD15	32	SA16					31	GP26	32	GP25
33	GP70	34	GP71	33	MEMCS16	34	SA15					33	GP30	34	GP27
35	GP72	36	GP73	35	IOCS16	36	SA14					35	GP32	36	GP31
37	GP74	38	GP75	37	REFRESH	38	SA13					37	XPCIRST-	38	GP33
39	GP76	40	GP77	39	GND	40	SA12					39	GND	40	GND
41	GP80	42	GP81	41	SYSCLK	42	SA11					41	XPE0_RX-	42	XPE0_TX-
43	GP82	44	GP83	43	IRQ7	44	SA10					43	XPE0_RX+	44	XPE0_TX+
45	GP84	46	GP85	45	IRQ6	46	SA9					45	GND	46	GND
47	GP86	48	GP87	47	IRQ5	48	SA8					47	XYPE0_CLK-	48	XUSB03-
49	GND	50	GND	49	IRQ4	50	GND					49	XYPE0_CLK+	50	XUSB03+

## 2.4 External I/O Overview

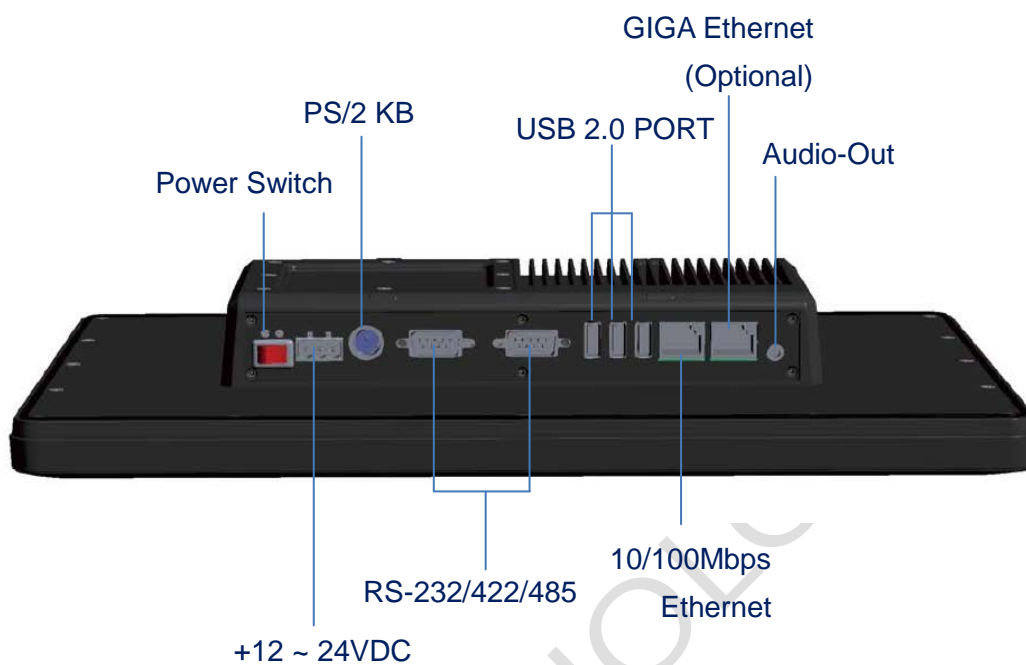

### NOTE

RS232/422/485 is selected by BIOS setting



## 2.5 External I/O Pin Assignment

### Power Switch

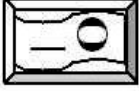
	Pin #	Status
		ON
	O	OFF

### Power Connector DC-IN +12~24V

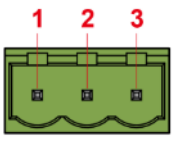
	Pin #	Signal Name
	1	+12~24V
	2	GND
	3	FG

### PS/2 Keyboard

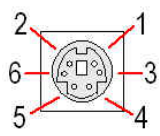
	Pin #	Signal Name
	1	KBCLK
	2	PMCLK
	3	GND
	4	KBDAT
	5	PMDAT
	6	SB5V

### J3 & J14: COM1 & 2 -RS232/422/485

(Change mode by BIOS Setup)

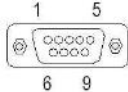
	Pin #	Signal Name	Pin #	Signal Name
	1	DCD1/422TX X-/RS485-	2	RXD1/422TX +/RS485+
	3	TXD1 / 422RX+	4	DTR1 / 422RX-
	5	GND	6	DSR1
	7	RTS1	8	CTS1
	9	RI1		

### J4/J5/J7: USB

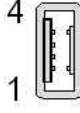
	Pin #	Signal Name
	1	VCC
	2	USB0-
	3	USB0+
	4	GND
	5	GGND
	6	GGND

### RJ45

	Pin #	Signal Name	Pin #	Signal Name
	1	FTXD+	2	FTXD-
	3	FRXIN+	4	NC
	5	NC	6	FRXIN-
	7	NC	8	NC

### RJ45 (Option for PoE)

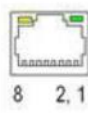
	Pin #	Signal Name	Pin #	Signal Name
	1	FTXD+	2	FTXD-
	3	FRXIN+	4	SP2
	5	SP2	6	FRXIN-
	7	SP1	8	SP1

### GIGA Ethernet (Optional)

	Pin #	Signal Name	Pin #	Signal Name
	1	GTX+	2	GTX-
	3	GRX+	4	GRX-
	5	GTXC+	6	GTXC-
	7	GRXD+	8	GRXD-

### Audio Line-Out

	Pin #	Signal Name
	1	GND
	2	LOUTL
	3	Open Touch
	4	Open Touch
	5	VREFOUT

## 2.6 Watchdog Timer

There are two watchdog timers in PPC-150P, we also provide DOS, Linux and WinCE example for your reference.

For more technical support, please visit: <http://tech.icop.com.tw> or download the PDF file: [dmp.com.tw/tech](http://dmp.com.tw/tech)

ICOP TECHNOLOGY INC.

# Ch. 3

## Hardware Installation

PPC-150P supports various kinds of storages for industrial application, divided into SATA Slim, CompactFlash or SD card (optional).

[3.1 Installing the SATA Slim](#)

[3.2 Installing the Compact Flash](#)

## 3.1 Installing the SATA Slim

### [SPEC]

JEDEC SFF-8156 standard form factor  
53 x 32 x 4.0 mm



### [SATA SLIM MLC LIST]

P/N	MLC	SLC	Operating Temperature
SDM-SST-SLIM(M)-4G	V		0°C ~ +70°C
SDM-SST-SLIM(M)-8G	V		0°C ~ +70°C
SDM-SST-SLIM(M)-16G	V		0°C ~ +70°C
SDM-SST-SLIM(M)-32G	V		0°C ~ +70°C
ISATA-SLIM(M)-8G	V		0°C ~ +70°C
ISATA-SLIM(M)-16G	V		0°C ~ +70°C
ISATA-SLIM(M)-32G	V		0°C ~ +70°C
ISATA-SLIM(M)-8G-X	V		-40°C ~ +85°C
ISATA-SLIM(M)-16G-X	V		-40°C ~ +85°C
ISATA-SLIM(M)-32G-X	V		-40°C ~ +85°C

### [STEP]

1. Remove the eight screws in a diagonal pattern as the image below.

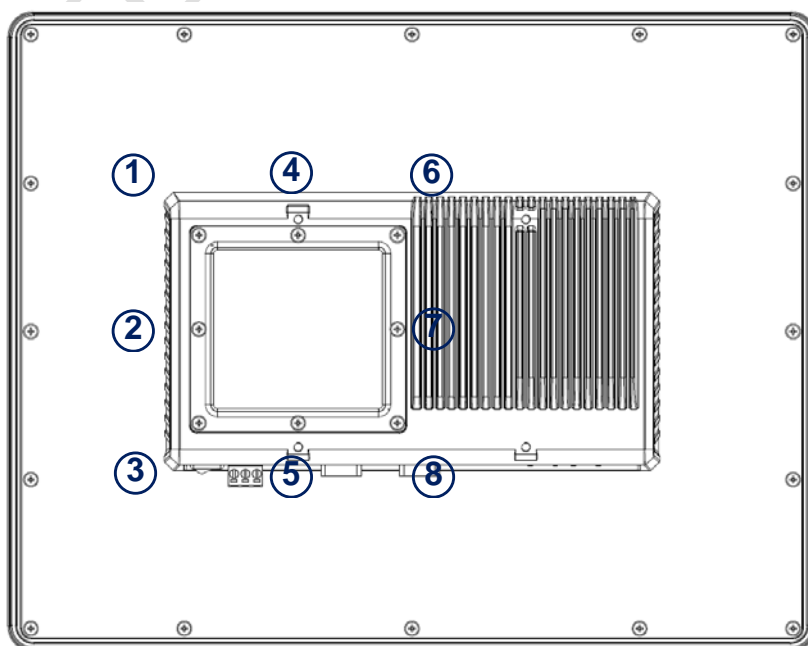

2. Place the SATA slim horizontally aligned and gently put into the socket until you feel a click.



3. Insert all eight screws into the screw holes.

ICOP TECHNOLOGY INC.

## 3.2 Installing the Compact Flash

### [STEP]

1. Remove the nine screws in a diagonal pattern as the image below.

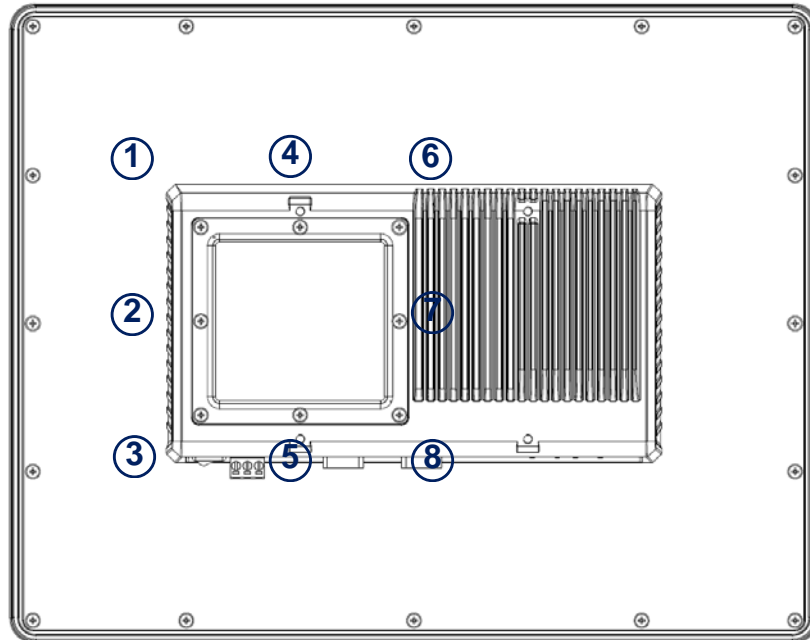

2. Gently insert the CF card along the track. Caution: Please watch out for the direction which the CF card has to be face up.

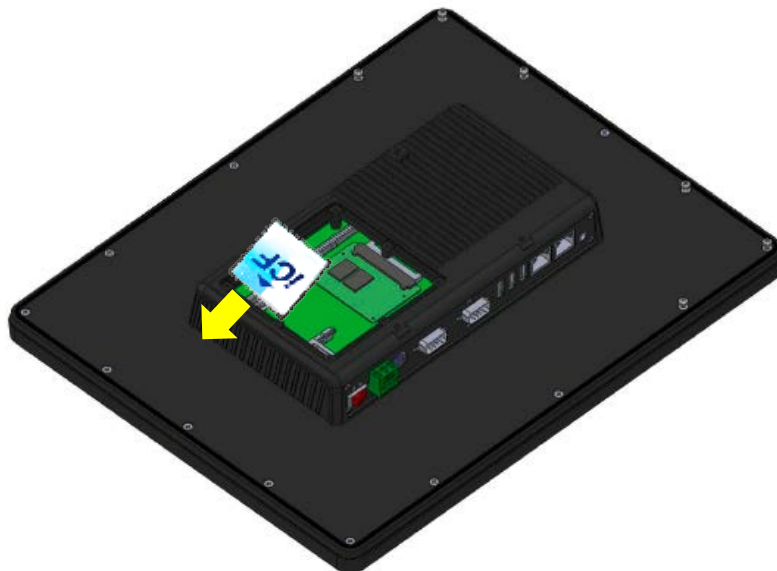

3. Insert all nine screws into the screw holes.

# Ch. 4

## Driver Installation

[4.1 PPC-150P Development Note](#)

[4.2 BIOS Default Setting](#)

[4.3 Serial Ports Setting \(RS232/RS422/RS485\)](#)

## VGA

The Vortex86DX2 / DX3 processor is integrated RDC Display chip which is an ultra-low powered graphics chipset with total power consumption at around 1-1.5 W.

## LAN

The Vortex86DX2 / DX3 processor is integrated 10/100Mbps Ethernet controller that supports both 10/100BASE-T and allows direct connection to your 10/100Mbps Ethernet based Local Area Network for full interaction with local servers, wide area networks such as the Internet.

I/O and IRQ settings can be done by software with the supplied utility software, or it can be set for Plug and Play compatibility. The controller supports: Half / Full-Duplex Ethernet function to double channel bandwidth, auto media detection.

## AUDIO

The ALC262 series are 4-Channel High Definition Audio Codecs with UAA (Universal Audio Architecture) featuring two 24-bit stereo DACs and three 20-bit stereo ADCs, they are designed for high performance multimedia desktop and laptop systems. The ALC262 series incorporates proprietary converter technology to achieve over 100dB Signal-to-Noise ratio playback quality; easily meeting PC2001 requirements and also bringing PC sound quality closer to consumer electronic devices.

## OPERATING SYSTEM SUPPORT

The PPC-150P provides the VGA and LAN drivers for Linux, Windows CE, Windows XP Professional, Windows 7, and Windows Embedded standard (XPE / WES2009 / WES7).

Please get the drivers from ICOP technical support URL: [tech.icop.com.tw](http://tech.icop.com.tw)

PPC-150P also supports most of the popular Linux distributions, for more detail information, please visit DMP official website: [vortex86dx2](http://vortex86dx2)



## 4.1 PPC-150P Development Note

### < WINDOWS DEVELOPMENT GUIDE >

Windows Embedded CE 6.0 BSP, Windows Embedded Compact 7 BSP, and Windows Embedded Standard 2009 trial image with development notes, please visit technical website to get more information at <http://tech.icop.com.tw/>.

### < LINUX INSTALLATION NOTE>

Please visit Linux technical website to get more information at [ftp://ftp.dmp.com.tw/Linux\\_DEMO/Vortex86\\_Linux\\_Support\\_List.htm](ftp://ftp.dmp.com.tw/Linux_DEMO/Vortex86_Linux_Support_List.htm).

ICOP TECHNOLOGY INC.

## 4.2 BIOS Default Setting

If the system cannot be booted after BIOS changes are made, Please follow below procedures in order to restore the CMOS as default setting.



Press < **End** > Key, when the power on



Press < **Del** > to enter the AMI BIOS setup



Press < **F9** > to Load Optimized defaults



Press < **F10** > to Save configuration changes and exit setup

---









## For DX3 processor:

Please press <Del> to get into the BIOS settings after booting the machine, and follow the steps below:

**[Step 1]** Use the arrow key to select the category "Advanced" on the top of the menu, then select "Serial/Parallel Port Configuration" in the sub menu and press <Enter>

```
Main  Advanced  PCIPnP  Boot  Security  Exit
*****
* Advanced Settings *
*****
* WARNING: Setting wrong values in below sections *
* may cause system to malfunction. *
*****
* * IDE Configuration *
* * Serial/Parallel Port Configuration *
* * Remote Access Configuration *
* * USB Configuration *
* * Power Management Configuration *
*****
* * * * *
* * Select Screen *
* * Select Item *
* * Enter Go to Sub Screen *
* * F1 General Help *
* * F10 Save and Exit *
* * ESC Exit *
* * * * *
*****
v02.67 (C)Copyright 1985-2009, American Megatrends, Inc.
```

**[Step 2]** Choose the port you would like to change. For example, choose "TXDEN1 Support" for COM1 and press <Enter>. You will then see the options; select the desired type and press <Enter> to finish the setting.

```
Advanced
*****
* TXDEN1 Support [232 Type] *
* TXDEN2 Support [232 Type] *
* SB Serial Port 1 [3F8] *
* Serial Port IRQ 1 [IRQ4] *
* Serial Port Boud Rate [115200 BPS] *
* SB Serial Port 2 [2F8] *
* Serial Port IRQ 2 *
* Serial Port Boud Rate *
*****
* * Options *
* * Disabled *
* * Enabled *
* * 232 Type *
* * 422 Type *
* * 485 Type *
*****
* * Select Screen *
* * Select Item *
* * +- Change Option *
* * F1 General Help *
* * F10 Save and Exit *
* * ESC Exit *
* * * * *
*****
v02.67 (C)Copyright 1985-2009, American Megatrends, Inc.
```





Press <Enter> and choose [OK] to keep your changes, then the device will reboot automatically.

```

Main  Advanced  PCIPnP  Boot  Security  Exit
*****
* Exit Options
* Save Changes and Exit
* Discard Changes and Exit
* Discard Changes
* Load Optimal Defaults
* Load Failsafe
* Save configuration changes and exit setup?
*
* [OK] [Cancel]
*
* Select Screen
* Enter Go to Sub Screen
* F1 General Help
* F10 Save and Exit
* ESC Exit
*****
v02.67 (C)Copyright 1985-2009, American Megatrends, Inc.

```



# Ch. 5

## Extension I/O (*Optional*)

[5.1 Extension I/O Overview](#)

[5.2 External I/O Pin Assignment](#)

## 5.1 Extension I/O Overview *(Optional)*

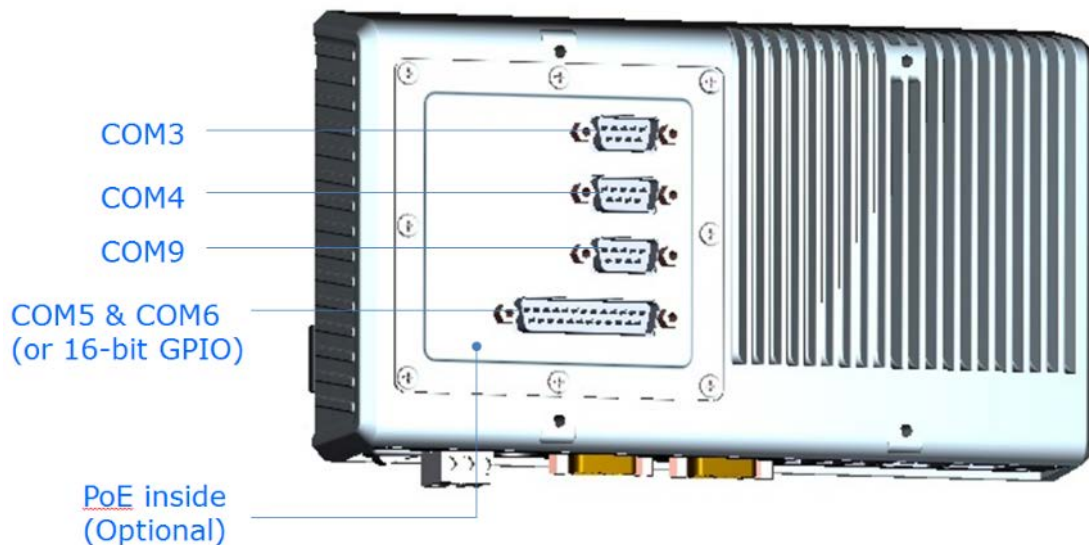

### NOTE:

1. Those COM ports are only for RS232 signals.
2. DSub-25pin only can be set to be either one of **COM5 & COM6** or **16-bit GPIO** by hardware settings, and user can't change hardware setting there. Thus, please contact your region sales person to order correct part number in advance.
3. **This model with more COM ports only supports SATA SLIM storage, but won't support CF card because the same pins of CF are used for more COM ports already.**
4. **Please order a SATA SLIM before assembling and shipping because SATA interface is located on the bottom of extension I/O board and user can not assemble.**
5. For **PoE+** function (IEEE 802.3at), highly recommend that user uses the max. **25.5watt** of **PoE+** switch/router/adaptor on PPC series.

## 5.2 Extension I/O Pin Assignment *(Optional)*

### COM3, 4 and 9 (RS232) (Change setting by BIOS)

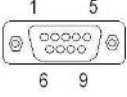
	Pin #	Signal Name	Pin #	Signal Name
	1	DCD1	2	RXD1
	3	TXD1	4	DTR1
	5	GND	6	DSR1
	7	RTS1	8	CTS1
	9	RI1		

### COM5 & 6 (RS232) / 16-bit GPIO

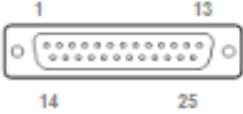
	Pin #	Signal Name	Pin #	Signal Name
	1	VCC (+5V_Output)	2	GND
	3	DCD5 / GPIO_00	4	TXD5 / GPIO_01
	5	RTS5 / GPIO_02	6	RI5 / GPIO_03
	7	GND	8	RXD5 / GPIO_04
	9	DTR5 / GPIO_05	10	DSR5 / GPIO_06
	11	CTS5 / GPIO_07	12	GND
	13	VCC (+5V_Output)	14	GND
	15	DCD6 / GPIO_10	16	TXD6 / GPIO_11
	17	RTS6 / GPIO_12	18	RI6 / GPIO_13
	19	GND	20	RXD6 / GPIO_14
	21	DTR6 / GPIO_15	22	DSR6 / GPIO_16
	23	CTS6 / GPIO_17	24	GND
	25	GND		

### IEEE 802.3at standard PoE+ pin out on RJ45 10/100Mbps Ethernet:

Pin	Alternative B	Pin	Alternative B
1	FTXD+	2	FTXD-
3	FRXIN+	4	Vport Positive
5	Vport Positive	6	FRXIN-
7	Vport Negative	8	Vport Negative

If you want to know more about PoE function, please refer the pin assignment on 2-5.

**Note:** The pin of "VCC" is for the pull up of GPIO pins if it is necessary for user. If GPIO pin is set to be output high, the maximum current of GPIO pin is 8mA only.

# Warranty

This product is warranted to be in good working order for a period of one year from the date of purchase. Should this product fail to be in good working order at any time during this period, we will, at our option, replace or repair it at no additional charge except as set forth in the following terms. This warranty does not apply to products damaged by misuse, modifications, accident or disaster. Vendor assumes no liability for any damages, lost profits, lost savings or any other incidental or consequential damage resulting from the use, misuse of, originality to use this product. Vendor will not be liable for any claim made by any other related party. Return authorization must be obtained from the vendor before returned merchandise will be accepted. Authorization can be obtained by calling or faxing the vendor and requesting a Return Merchandise Authorization (RMA) number. Returned goods should always be accompanied by a clear problem description.

All Trademarks appearing in this manuscript are registered trademark of their respective owners. All Specifications are subject to change without notice.  
©ICOP Technology Inc. 2018