



NEXCOM International Co., Ltd.

Intelligent Platform & Services Business Unit
Edge Computing System
Neu-X100
User Manual

NEXCOM International Co., Ltd.
Published March 2021

www.nexcom.com

CONTENTS

Preface

Copyright	iv
Disclaimer	iv
Acknowledgements	iv
Regulatory Compliance Statements	iv
Declaration of Conformity	iv
RoHS Compliance	v
Warranty and RMA	vi
Safety Information	viii
Installation Recommendations	viii
Safety Precautions	ix
Technical Support and Assistance	x
Conventions Used in this Manual	x
Global Service Contact Information	xi
Package Contents	xiii
Ordering Information	xiv

Chapter 1: Product Introduction

Neu-X100	1
Overview	1
Key Features	1
Hardware Specifications	2
Physical Features	3
Front Panel	3
Rear Panel	3
Mechanical Dimensions	4

Chapter 2: Jumpers and Connectors

Before You Begin	5
Precautions	5
Jumper Settings	6
Locations of the Jumpers and Connectors for Neu-X100	7
Top View	7
Bottom View	8
Jumpers & DIP Switches	9
AT/ATX Mode Select	9
Clear CMOS	9
LVDS Panel Voltage Select	10
Backlight Control Voltage Select (Dimming)	10
LVDS Resolution Select	11
Connector Pin Definitions	12
External Connector	12
COM1 DB9 Male Connector	12
Internal Connectors	13
LVDS Inverter Connector	13
System Reset Header	13
LED Connector	14
HDD LED Connector	14
Line-out Connector	15
USB Connector	15
USB Touch	16
System Power Button Header	16
DC Power Input	17



FAN Connector	17
Debug Port/LPC Bus Connector	18
COM Port Connector	18
Battery Connector.....	19
LVDS Panel Connector.....	19
Mini-PCIe Connector.....	20
M.2 Connector (M-Key)	21

Chapter 3: System Setup

Removing the Chassis Cover	22
Installing a SO-DIMM Memory Module & M.2 M Key SSD Module (2242).....	23
Installing a Half-size Wi-Fi Module (Mini-PCIe Slot)	24
Wall Mounting Instructions	27

Chapter 4: BIOS Setup

About BIOS Setup	28
When to Configure the BIOS.....	28
Default Configuration.....	29
Entering Setup	29
Legends	29
BIOS Setup Utility.....	31
Main	31
Advanced.....	32
Chipset.....	39
Security	42
Boot	43
Save & Exit	44

PREFACE

Copyright

This publication, including all photographs, illustrations and software, is protected under international copyright laws, with all rights reserved. No part of this manual may be reproduced, copied, translated or transmitted in any form or by any means without the prior written consent from NEXCOM International Co., Ltd.

Disclaimer

The information in this document is subject to change without prior notice and does not represent commitment from NEXCOM International Co., Ltd. However, users may update their knowledge of any product in use by constantly checking its manual posted on our website: <http://www.nexcom.com>. NEXCOM shall not be liable for direct, indirect, special, incidental, or consequential damages arising out of the use of any product, nor for any infringements upon the rights of third parties, which may result from such use. Any implied warranties of merchantability or fitness for any particular purpose is also disclaimed.

Acknowledgements

Neu-X100 is a trademark of NEXCOM International Co., Ltd. All other product names mentioned herein are registered trademarks of their respective owners.

Regulatory Compliance Statements

This section provides the FCC compliance statement for Class A devices and describes how to keep the system CE compliant.

Declaration of Conformity

FCC

This equipment has been tested and verified to comply with the limits for a Class A digital device, pursuant to Part 15 of FCC Rules. These limits are designed to provide reasonable protection against harmful interference when the equipment is operated in a commercial environment. This equipment generates, uses, and can radiate radio frequency energy and, if not installed and used in accordance with the instructions, may cause harmful interference to radio communications. Operation of this equipment in a residential area (domestic environment) is likely to cause harmful interference, in which case the user will be required to correct the interference (take adequate measures) at their own expense.

CE

The product(s) described in this manual complies with all applicable European Union (CE) directives if it has a CE marking. For computer systems to remain CE compliant, only CE-compliant parts may be used. Maintaining CE compliance also requires proper cable and cabling techniques.

RoHS Compliance



NEXCOM RoHS Environmental Policy and Status Update

NEXCOM is a global citizen for building the digital infrastructure. We are committed to providing green products and services, which are compliant with European Union RoHS (Restriction on Use of Hazardous Substance in Electronic Equipment) directive 2011/65/EU, to be your trusted green partner and to protect our environment.

RoHS restricts the use of Lead (Pb) < 0.1% or 1,000ppm, Mercury (Hg) < 0.1% or 1,000ppm, Cadmium (Cd) < 0.01% or 100ppm, Hexavalent Chromium (Cr6+) < 0.1% or 1,000ppm, Polybrominated biphenyls (PBB) < 0.1% or 1,000ppm, and Polybrominated diphenyl Ethers (PBDE) < 0.1% or 1,000ppm.

In order to meet the RoHS compliant directives, NEXCOM has established an engineering and manufacturing task force to implement the introduction of green products. The task force will ensure that we follow the standard NEXCOM development procedure and that all the new RoHS components and new manufacturing processes maintain the highest industry quality levels for which NEXCOM are renowned.

The model selection criteria will be based on market demand. Vendors and suppliers will ensure that all designed components will be RoHS compliant.

How to recognize NEXCOM RoHS Products?

For existing products where there are non-RoHS and RoHS versions, the suffix "(LF)" will be added to the compliant product name.

All new product models launched after January 2013 will be RoHS compliant. They will use the usual NEXCOM naming convention.

Warranty and RMA

NEXCOM Warranty Period

NEXCOM manufactures products that are new or equivalent to new in accordance with industry standard. NEXCOM warrants that products will be free from defect in material and workmanship for 2 years, beginning on the date of invoice by NEXCOM.

NEXCOM Return Merchandise Authorization (RMA)

- Customers shall enclose the “NEXCOM RMA Service Form” with the returned packages.
- Customers must collect all the information about the problems encountered and note anything abnormal or, print out any on-screen messages, and describe the problems on the “NEXCOM RMA Service Form” for the RMA number apply process.
- Customers can send back the faulty products with or without accessories (manuals, cable, etc.) and any components from the card, such as CPU and RAM. If the components were suspected as part of the problems, please note clearly which components are included. Otherwise, NEXCOM is not responsible for the devices/parts.
- Customers are responsible for the safe packaging of defective products, making sure it is durable enough to be resistant against further damage and deterioration during transportation. In case of damages occurred during transportation, the repair is treated as “Out of Warranty.”
- Any products returned by NEXCOM to other locations besides the customers’ site will bear an extra charge and will be billed to the customer.

Repair Service Charges for Out-of-Warranty Products

NEXCOM will charge for out-of-warranty products in two categories, one is basic diagnostic fee and another is component (product) fee.

System Level

- Component fee: NEXCOM will only charge for main components such as SMD chip, BGA chip, etc. Passive components will be repaired for free, ex: resistor, capacitor.
- Items will be replaced with NEXCOM products if the original one cannot be repaired. Ex: motherboard, power supply, etc.
- Replace with 3rd party products if needed.
- If RMA goods can not be repaired, NEXCOM will return it to the customer without any charge.

Board Level

- Component fee: NEXCOM will only charge for main components, such as SMD chip, BGA chip, etc. Passive components will be repaired for free, ex: resistors, capacitors.
- If RMA goods can not be repaired, NEXCOM will return it to the customer without any charge.

Warnings

Read and adhere to all warnings, cautions, and notices in this guide and the documentation supplied with the chassis, power supply, and accessory modules. If the instructions for the chassis and power supply are inconsistent with these instructions or the instructions for accessory modules, contact the supplier to find out how you can ensure that your computer meets safety and regulatory requirements.

Cautions

Electrostatic discharge (ESD) can damage system components. Do the described procedures only at an ESD workstation. If no such station is available, you can provide some ESD protection by wearing an antistatic wrist strap and attaching it to a metal part of the computer chassis.

Safety Information

Before installing and using the device, note the following precautions:

- Read all instructions carefully.
- Do not place the unit on an unstable surface, cart, or stand.
- Follow all warnings and cautions in this manual.
- When replacing parts, ensure that your service technician uses parts specified by the manufacturer.
- Avoid using the system near water, in direct sunlight, or near a heating device.
- The load of the system unit does not solely rely for support from the rackmounts located on the sides. Firm support from the bottom is highly necessary in order to provide balance stability.
- The computer is provided with a battery-powered real-time clock circuit. There is a danger of explosion if battery is incorrectly replaced. Replace only with the same or equivalent type recommended by the manufacturer. Discard used batteries according to the manufacturer's instructions.

Installation Recommendations

Ensure you have a stable, clean working environment. Dust and dirt can get into components and cause a malfunction. Use containers to keep small components separated.

Adequate lighting and proper tools can prevent you from accidentally damaging the internal components. Most of the procedures that follow require only a few simple tools, including the following:

- A Philips screwdriver
- A flat-tipped screwdriver
- A grounding strap
- An anti-static pad

Using your fingers can disconnect most of the connections. It is recommended that you do not use needle-nose pliers to disconnect connections as these can damage the soft metal or plastic parts of the connectors.

Safety Precautions

1. Read these safety instructions carefully.
2. Keep this User Manual for later reference.
3. Disconnect this equipment from any AC outlet before cleaning. Use a damp cloth. Do not use liquid or spray detergents for cleaning.
4. For plug-in equipment, the power outlet socket must be located near the equipment and must be easily accessible.
5. Keep this equipment away from humidity.
6. Put this equipment on a stable surface during installation. Dropping it or letting it fall may cause damage.
7. The openings on the enclosure are for air convection to protect the equipment from overheating. DO NOT COVER THE OPENINGS.
8. Make sure the voltage of the power source is correct before connecting the equipment to the power outlet.
9. Place the power cord in a way so that people will not step on it. Do not place anything on top of the power cord. Use a power cord that has been approved for use with the product and that it matches the voltage and current marked on the product's electrical range label. The voltage and current rating of the cord must be greater than the voltage and current rating marked on the product.
10. All cautions and warnings on the equipment should be noted.
11. If the equipment is not used for a long time, disconnect it from the power source to avoid damage by transient overvoltage.
12. Never pour any liquid into an opening. This may cause fire or electrical shock.
13. Never open the equipment. For safety reasons, the equipment should be opened only by qualified service personnel.
14. If one of the following situations arises, get the equipment checked by service personnel:
 - a. The power cord or plug is damaged.
 - b. Liquid has penetrated into the equipment.
 - c. The equipment has been exposed to moisture.
 - d. The equipment does not work well, or you cannot get it to work according to the user's manual.
 - e. The equipment has been dropped and damaged.
 - f. The equipment has obvious signs of breakage.
15. Do not place heavy objects on the equipment.
16. The unit uses a three-wire ground cable which is equipped with a third pin to ground the unit and prevent electric shock. Do not defeat the purpose of this pin. If your outlet does not support this kind of plug, contact your electrician to replace your obsolete outlet.
17. **CAUTION:** DANGER OF EXPLOSION IF BATTERY IS INCORRECTLY REPLACED. REPLACE ONLY WITH THE SAME OR EQUIVALENT TYPE RECOMMENDED BY THE MANUFACTURER. DISCARD USED BATTERIES ACCORDING TO THE MANUFACTURER'S INSTRUCTIONS.
18. Ensure to connect the power cord of the power adapter to a socket-outlet with earthing connection.
19. This product is intended to be supplied by a Listed Power Adapter or DC power source, rated 19Vdc, minimum 2.37A, minimum T ma=50 degree C, minimum altitude of operation=2000m, and evaluated in accordance to UL/IEC 60950-1 and/or UL/IEC 62368-1. If further assistance is needed, please contact NEXCOM International Co., Ltd. (UL file owner or brand owner) for further information.

Technical Support and Assistance

1. For the most updated information of NEXCOM products, visit NEXCOM's website at www.nexcom.com.
2. For technical issues that require contacting our technical support team or sales representative, please have the following information ready before calling:
 - Product name and serial number
 - Detailed information of the peripheral devices
 - Detailed information of the installed software (operating system, version, application software, etc.)
 - A complete description of the problem
 - The exact wordings of the error messages

Warning!

1. Handling the unit: carry the unit with both hands and handle it with care.
2. Maintenance: to keep the unit clean, use only approved cleaning products or clean with a dry cloth.

Conventions Used in this Manual



Warning:

Information about certain situations, which if not observed, can cause personal injury. This will prevent injury to yourself when performing a task.



Caution:

Information to avoid damaging components or losing data.



Note:

Provides additional information to complete a task easily.

Global Service Contact Information

Headquarters

NEXCOM International Co., Ltd.

9F, No. 920, Chung-Cheng Rd.,
Zhonghe District, New Taipei City, 23586,
Taiwan, R.O.C.
Tel: +886-2-8226-7786
Fax: +886-2-8226-7782
www.nexcom.com

Asia

Taiwan

NexAIoT Headquarters

Industry 4.0 and Cloud Services

13F, No.916, Zhongzheng Rd.,
Zhonghe District, New Taipei City,
23586, Taiwan, R.O.C.
Tel: +886-2-8226-7796
Fax: +886-2-8226-7926
Email: sales@nexaiot.com
www.nexaiot.com

NexAIoT Co., Ltd.

Taichung Office

16F, No.250, Sec. 2, Chongde Rd.,
Beitun District,
Taichung City, 406, Taiwan, R.O.C.
Tel: +886-4-2249-1179
Fax: +886-4-2249-1172
Email: sales@nexaiot.com
www.nexaiot.com

NexCOBOT Taiwan Co., Ltd.

13F, No.916, Chung-Cheng Rd.,
Zhonghe District,
New Taipei City, 23586, Taiwan, R.O.C.
Tel: +886-2-8226-7786
Fax: +886-2-8226-7926
Email: sales@nexcobot.com
www.nexcobot.com

GreenBase Technology Corp.

13F, No.922, Chung-Cheng Rd.,
Zhonghe District,
New Taipei City, 23586, Taiwan, R.O.C.
Tel: +886-2-8226-7786
Fax: +886-2-8226-7900
Email: sales@nexcom.com.tw
www.nexcom.com.tw

EMBUX Technology Co., Ltd.

13F, No.916, Chung-Cheng Rd.,
Zhonghe District,
New Taipei City, 23586, Taiwan, R.O.C.
Tel: +886-2-8226-7786
Fax: +886-2-8226-7782
Email: sales@nexcom.com.tw
www.nexcom.com.tw

TMR Technology Corp.

13F, No.916, Chung-Cheng Rd.,
Zhonghe District,
New Taipei City, 23586, Taiwan, R.O.C.
Tel: +886-2-8226-7786
Fax: +886-2-8226-7782
Email: sales@nexcom.com.tw
www.nexcom.com.tw

China

NEXSEC Incorporated

5F, No.4, No.7 Fengxian Middle Rd.,
(Beike Industrial Park), Haidian District,
Beijing, 100094, China
Tel: +86-10-5704-2680
Fax: +86-10-5704-2681
Email: marketing@nexsec.cn
www.nexsec.cn

NEXCOM Shanghai

No.4, 16 Building,
Shanghai OMNI Tech & Science Park
No. 1699, Dohui Rd.,
Shanghai, 201108, China
Tel: +86-21-5278-5868
Fax: +86-21-3251-6358
Email: sales@nexcom.cn
www.nexcom.cn

NEXCOM Surveillance Technology Corp.

5F, Building C, ZhenHan Industrial Zone,
GanKeng Community, Buji Street,
LongGang District,
ShenZhen, 518112, China
Tel: +86-755-8364-7768
Fax: +86-755-8364-7738
Email: steveyang@nexcom.com.tw
www.nexcom.cn

NEXCOM United System Service

Room 603/604, Huiyinmingzun Plaza Bldg. 1,
No. 609, Yunlin East Rd.,
Shanghai, 200062, China
Tel: +86-21-5278-5868
Fax: +86-21-3251-6358
Email: renwang@nexcom.com.tw
www.nexcom.cn

NEXGOL Chongqing

1F, Building B4, Electronic 2nd Area,
(Phoenix Lake Industrial Park), Yongchuan Dist.,
Chongqing City, 402160, China
Tel: +86-23-4960-9080
Fax: +86-23-4966-5855
Email: sales@nexgol.com.cn
www.nexcobot.com/NexGOL

NexCOBOT China

Room 501, Building 1, Haichuang Building,
No.7 Qingyi Road, Guicheng Street,
Nanhai District, Foshan City,
Guangdong Province, 528314, China
Tel: +86-757-8625-7118
Email: sales@nexcobot.com
www.nexcobot.com.cn

Beijing NexGemo Technology Co.,Ltd.

5F, Gemotech Building, No.1, Development Rd.,
Changping International Information Industry Base,
Changping District,
Beijing, 102206, China
Tel: +86-10-8190-9328
Fax: +86-10-8190-9456
Email: sales@gemotech.cn
www.nexgemo.cn

Japan

NEXCOM Japan

9F, Tamachi Hara Bldg.,
4-11-5, Shiba Minato-ku,
Tokyo, 108-0014, Japan
Tel: +81-3-5419-7830
Fax: +81-3-5419-7832
Email: sales@nexcom-jp.com
www.nexcom-jp.com

America

USA NEXCOM USA

46665 Fremont Blvd.,
Fremont CA 94538, USA
Tel: +1-510-656-2248
Fax: +1-510-656-2158
Email: sales@nexcom.com
www.nexcomusa.com

NexCOBOT USA

2883 Bayview Drive,
Fremont CA 94538, USA
Tel: +1-510-362-0800
Fax: +1-510-656-2158
Email: sales@nexcobot.com
www.nexcobot.com

Europe

United Kingdom NEXCOM EUROPE

10 Vincent Avenue,
Crownhill Business Centre,
Milton Keynes, Buckinghamshire
MK8 0AB, United Kingdom
Tel: +44-1908-267121
Fax: +44-1908-262042
Email: sales.uk@nexcom.eu
www.nexcom.co.uk

Package Contents

Before continuing, verify that the Neu-X100 package that you received is complete. Your package should have all the items listed in the following table.

Item	Name	Qty
1	Neu-X100 System	1
2	Power Adapter	1

Optional Accessories

Item	Part Number	Name	Description
1	5060200355X00	Thermal Pad For Memory	Thermal Pad for VTC 7240-Moto E-LIN 60x20x2mm K=2w/mk S3S
2	5060200417X00	Thermal Pad For M.2	Thermal Pad T-Global:TG4040 30x25x1.5mm K=4 w/mK-UJL
3	7400045002X00	Power Adapter	Power Adapter for Neu-X100 Series FSP:FSP045-RBBN3 45W 19V/2.37A
4	5040420019X00	Mini-Card Bracket	Mini-Card Bracket for NDIS M323 VER:A CHYUAN-JYH 29x30x2.1mm t=1.0mm SPCC+NI
5	50311F0295X00	Screw	Flat Head Screw Long Fei:F2x4 Nylok NIGP F2x4 NIGP Nylok
6	50311F0111X00	Screw	Flat Head Screw Long Fei:F3x5ISO+Nylok Black F3x5 Black Nylok

Ordering Information

The following below provides ordering information for Neu-X100.

Neu-X100-N3350 (P/N: 10W10X10000X4)

Intel® Celeron® N3350 processor (formerly codenamed “Apollo Lake”) slim and fanless system

Neu-X100-N4200 (P/N: 10W10X10001X4)

Intel® Pentium® N4200 processor (formerly codenamed “Apollo Lake”) slim and fanless system

Neu-X100-J3455 (P/N: 10W10X10002X4)

Intel® Celeron® J3455 processor (formerly codenamed “Apollo Lake”) slim and fanless system

CHAPTER 1: PRODUCT INTRODUCTION

Neu-X100

Overview



Key Features

- Intel® Celeron® Processor N3350, Intel® Pentium® N4200 or Intel® Celeron® Processor J3455 (formerly codenamed “Apollo Lake”)
- Slim chassis design in a 3.5” MB form factor
- Support HDMI 2.0 output
- Fanless design
- Mini-PCIe slot supports Wi-Fi and LTE module

Hardware Specifications

CPU Support

- Intel® Celeron® Processor N3350 (2.40GHz, 6W TDP)
- Intel® Pentium® Processor N4200 (2.50GHz, 6W TDP)
- Intel® Celeron® Processor J3455 (2.30GHz, 10W TDP)

Graphics

- Intel® HD Graphics 500 (with N3350/J3455)
- Intel® HD Graphics 505 (with N4200)

Main Memory

- 1x 204-pin SO-DIMM socket, supports up to DDR3L 1866MHz, non-ECC, un-buffered memory up to 8GB

I/O Interface-Front

- 2 x RJ45 with LEDs for Gigabit LAN
- 2 x HDMI 2.0, 4096 x 2160 resolution @ 60Hz
- 1 x COM port (RS232/RS422/RS485)
- 1 x DC-in jack with lock
- 2 x USB 3.0

I/O Interface-Rear

- 2 x Antenna holes
- 1 x Power button with LED
- 1 x Storage active LED

Internal I/O

- 1 x COM port connector (RS232)
- 1 x Power connector
- 1 x TPM module connector
- 1 x Line-out audio connector

Expansion

- 1 x Mini-PCIe full-size connector, supports Wi-Fi/LTE module
- 1 x SIM slot on board (full-size)

Storage

- 1 x M.2 M key 2242 SSD

Power Supply

- 1 x External 45W AC/DC power adapter with lock
- Input: 100VAC to 240VAC
- Output: DC+19VDC

Environment

- Operating temperature: -5°C to 50°C
- Storage temperature: -20°C to 80°C
- Humidity: 95% (non-condensing)

Certification

- CE (EMC EN55032 + EN55035)
- FCC Class A (EMI Part 15B)

Dimensions

- 155mm (W) x 106mm (D) x 37mm (H)

Operating System

- Windows 10 64-bit
- Linux 4.1

Physical Features

Front Panel

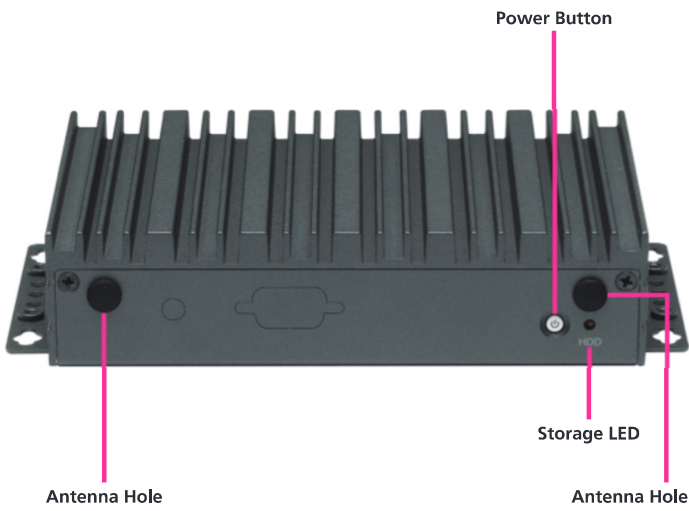

Rear Panel

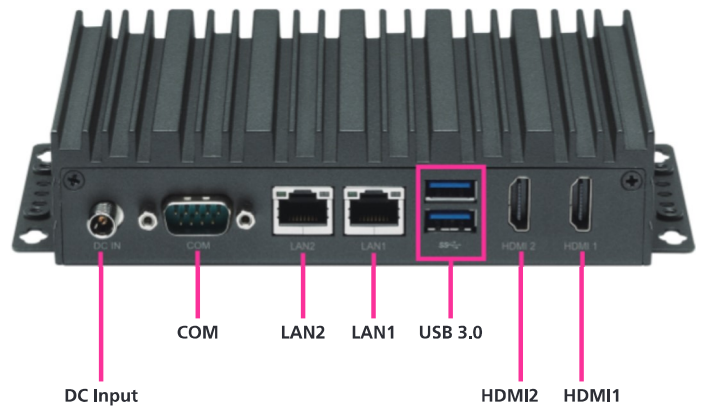

Mechanical Dimensions

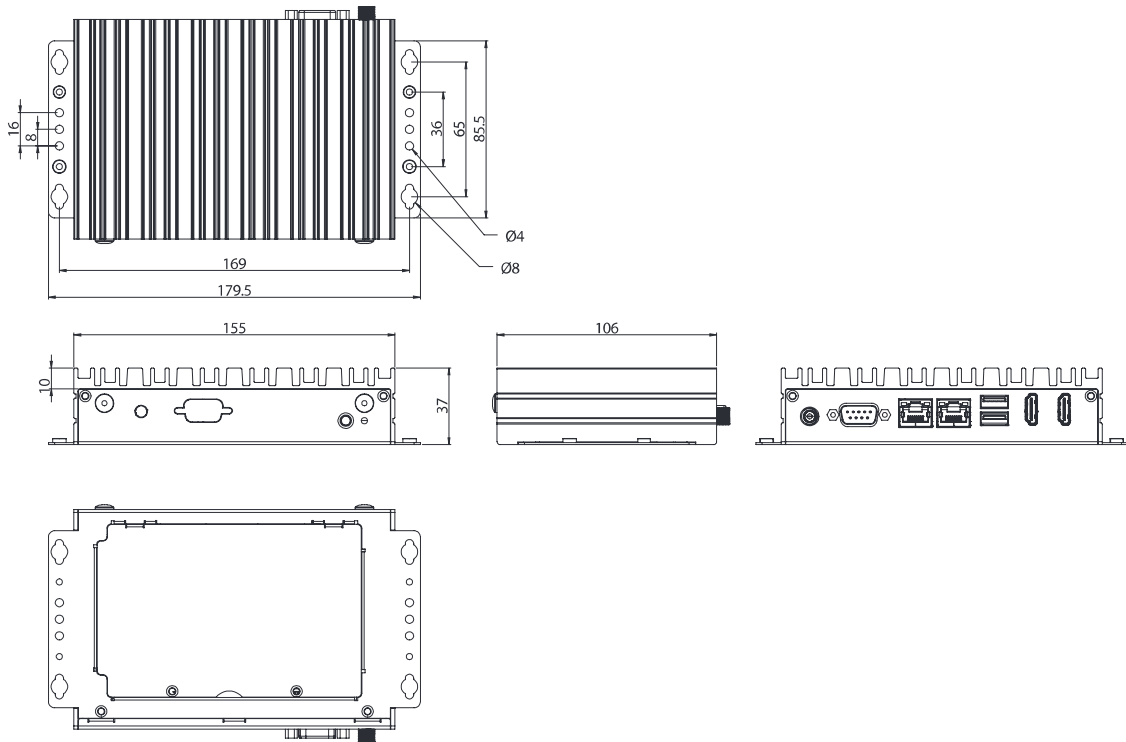

CHAPTER 2: JUMPERS AND CONNECTORS

This chapter lists the locations of the jumpers and connectors for Neu-X100.

Before You Begin

- Ensure you have a stable, clean working environment. Dust and dirt can get into components and cause a malfunction. Use containers to keep small components separated.
- Adequate lighting and proper tools can prevent you from accidentally damaging the internal components. Most of the procedures that follow require only a few simple tools, including the following:
 - A Philips screwdriver
 - A flat-tipped screwdriver
 - A set of jewelers screwdrivers
 - A grounding strap
 - An anti-static pad
- Using your fingers can disconnect most of the connections. It is recommended that you do not use needle-nosed pliers to disconnect connections as these can damage the soft metal or plastic parts of the connectors.
- Before working on internal components, make sure that the power is off. Ground yourself before touching any internal components, by touching a metal object. Static electricity can damage many of the electronic components. Humid environments tend to have less static electricity than dry environments. A grounding strap is warranted whenever danger of static electricity exists.

Precautions

Computer components and electronic circuit boards can be damaged by discharges of static electricity. Working on computers that are still connected to a power supply can be extremely dangerous.

Follow the guidelines below to avoid damage to your computer or yourself:

- Always disconnect the unit from the power outlet whenever you are working inside the case.
- If possible, wear a grounded wrist strap when you are working inside the computer case. Alternatively, discharge any static electricity by touching the bare metal chassis of the unit case, or the bare metal body of any other grounded appliance.
- Hold electronic circuit boards by the edges only. Do not touch the components on the board unless it is necessary to do so. Don't flex or stress the circuit board.
- Leave all components inside the static-proof packaging that they shipped with until they are ready for installation.
- Use correct screws and do not over tighten screws.

Jumper Settings

A jumper is the simplest kind of electric switch. It consists of two metal pins and a cap. When setting the jumpers, ensure that the jumper caps are placed on the correct pins. When the jumper cap is placed on both pins, the jumper is short. If you remove the jumper cap, or place the jumper cap on just one pin, the jumper is open.

Refer to the illustrations below for examples of what the 2-pin and 3-pin jumpers look like when they are short (on) and open (off).

Two-Pin Jumpers: Open (Left) and Short (Right)

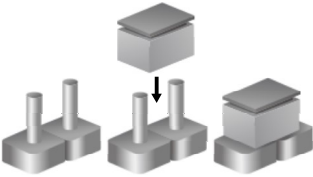

Three-Pin Jumpers: Pins 1 and 2 are Short

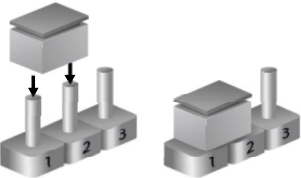

Locations of the Jumpers and Connectors for Neu-X100

The figure below is the top and bottom view of the mainboard used in Neu-X100. It shows the locations of the jumpers and connectors.

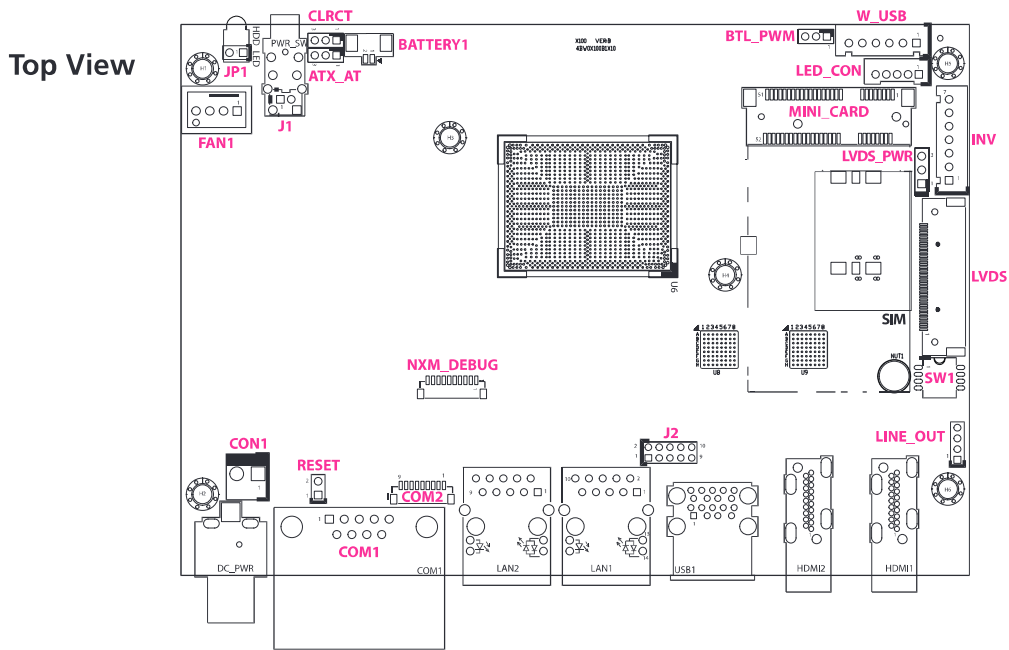

Bottom View

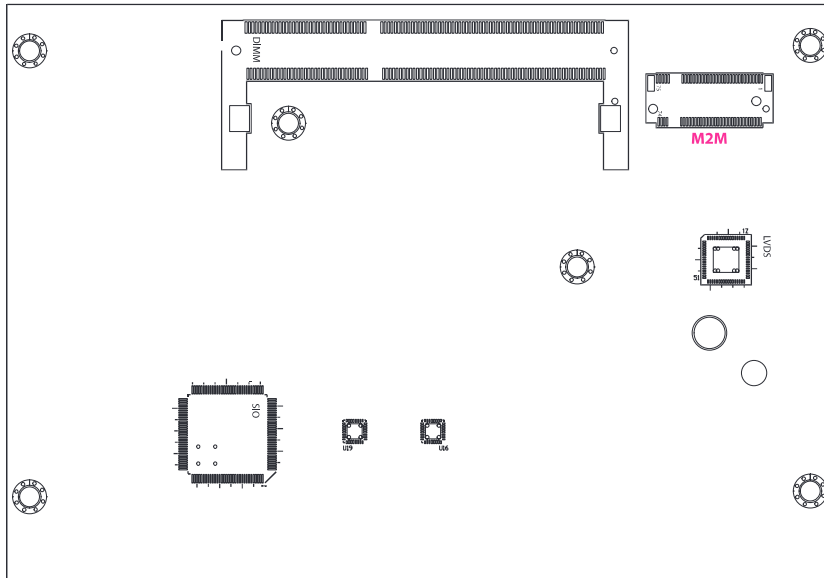

Jumpers & DIP Switches

AT/ATX Mode Select

Connector type: 1x3 3-pin header, 2.0mm pitch
Connector location: ATX_AT



Pin	Settings
1-2 On	ATX Mode
2-3 On	AT Mode

1-2 On: default

Clear CMOS

Connector type: 1x3 3-pin header, 2.0mm pitch
Connector location: CLRTC



Pin	Settings
1-2 On	Normal
2-3 On	Clear CMOS

1-2 On: default

LVDS Panel Voltage Select

Connector type: 1x3 3-pin header, 2.54mm pitch
Connector location: LVDS_PWR



Pin	Settings
1-2 On	3.3V
2-3 On	5V

1-2 On: default

Backlight Control Voltage Select (Dimming)

Connector type: 1x3 3-pin header, 2.0mm pitch
Connector location: BLT_PWM



Pin	Settings
1-2 On	3.3V
2-3 On	5V

2-3 On: default

LVDS Resolution Select

Connector type: 4-pin DIP switch
Connector location: SW1

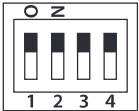

SW [3:0]	SW1 [3]	SW1 [2]	SW1 [1]	SW1 [0]	Function
0000	ON	ON	ON	ON	800 x 600 6-bit Single Port
0001	ON	ON	ON	OFF	1024 x 768 6-bit Single Port
0010	ON	ON	OFF	ON	1024 x 768 8-bit Single Port
0011	ON	ON	OFF	OFF	1280 x 1024 6-bit Single Port
0100	ON	OFF	ON	ON	1280 x 800 6-bit Single Port
0101	ON	OFF	ON	OFF	1280 x 800 8-bit Single Port
0110	ON	OFF	OFF	ON	1280 x 1024 8-bit Dual Port
0111	ON	OFF	OFF	OFF	1366 x 768 6-bit Single Port
1000	OFF	ON	ON	ON	1366 x 768 8-bit Single Port
1001	OFF	ON	ON	OFF	1440 x 900 8-bit Dual Port
1010	OFF	ON	OFF	ON	1400 x 1050 8-bit Dual Port
1011	OFF	ON	OFF	OFF	1600 x 900 8-bit Dual Port
1100	OFF	OFF	ON	ON	1680 x 1050 8-bit Dual Port
1101	OFF	OFF	ON	OFF	1600 x 1200 8-bit Dual Port
1110	OFF	OFF	OFF	ON	1920 x 1080 8-bit Dual Port
1111	OFF	OFF	OFF	OFF	1920 x 1200 8-bit Dual Port

Connector Pin Definitions

External Connector

COM1 DB9 Male Connector

Connector type: DB-9 port, 9-pin D-Sub

Connector location: COM1

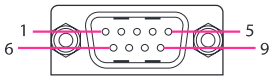

RS232		RS422		RS485	
Pin	Definition	Pin	Definition	Pin	Definition
1	DCD	1	TX-	1	TR-
2	RXD	2	TX+	2	TR+
3	TXD	3	RX+	3	
4	DTR	4	RX-	4	
5	GND	5		5	
6	DSR	6		6	
7	RTS	7		7	
8	CTS	8		8	
9	RI	9		9	

Internal Connectors

LVDS Inverter Connector

Connector type: 1x7 7-pin header JST, 2.5mm pitch
 Connector location: INV

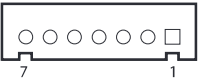

Pin	Definition	Pin	Definition
1	5V	2	12V
3	12V	4	Backlight Control
5	GND	6	GND
7	Backlight Enable		

System Reset Header

Connector type: 1x2 2-pin header, 2.54mm pitch
 Connector location: RESET



Pin	Definition
1	RESET#
2	GND

LED Connector

Connector type: 1x5 5-pin header JST, 2.0mm pitch
 Connector location: LED_CON



Pin	Definition	Pin	Definition
1	HDD_LED-	2	HDD_LED+
3	GND	4	Standby LED
5	PWR LED		

HDD LED Connector

Connector type: 1x2 2-pin header, 2.54mm pitch
 Connector location: JP1



Pin	Definition
1	HDD_LED+
2	HDD_LED-

Line-out Connector

Connector type: 1x4 4-pin header, 2.0mm pitch
 Connector location: LINE_OUT



Pin	Definition	Pin	Definition
1	LOUT_L	2	GND
3	LOUT_JD	4	LOUT_R

USB Connector

Connector type: 2x5 10-pin header
 Connector location: J2



Pin	Definition	Pin	Definition
1	+5V_USB2_P45	2	GND
3	S_USB2DN4	4	GND
5	S_USB2DP4	6	S_USB2DP5
7	GND	8	S_USB2DN5
9	GND	10	+5V_USB2_P45

USB Touch

Connector type: 1x6 6-pin header JST, 2.5mm pitch
 Connector location: W_USB

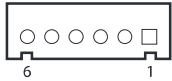

Pin	Definition	Pin	Definition
1	+5V_USB2_P2	2	S_USB2DN2
3	S_USB2DP2	4	S_USB2DN6
5	S_USB2DP6	6	GND

System Power Button Header

Connector type: 1x2 2-pin header JST, 2.0mm pitch
 Connector location: J1



Pin	Definition
1	GND
2	PWRBTN#

DC Power Input

Connector type: 1x2 2-pin header, 3.96mm pitch
 Connector location: CON1



Pin	Definition
1	GND
2	+DC_IN

FAN Connector

Connector type: 1x4 4-pin header, 2.54mm pitch
 Connector location: FAN1

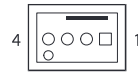

Pin	Definition	Pin	Definition
1	GND	2	+12V
3	FAN SPEED DETECT	4	FAN SPEED CONTROL

Debug Port/LPC Bus Connector

Connector type: 1x10 10-pin header, 1.0mm pitch
 Connector location: NXM_DEBUG



Pin	Definition	Pin	Definition
1	+3V	2	SERIRQ
3	LAD0	4	LAD1
5	LAD2	6	LAD3
7	LFRAME#	8	25MHZ
9	PLTRST#	10	GND

COM Port Connector

Connector type: 1x9 9-pin header, 1.0mm pitch
 Connector location: COM2



Pin	Definition	Pin	Definition
1	DCD	2	RXD
3	TXD	4	DTR
5	GND	6	DSR
7	RTS	8	CTS
9	RI		

Battery Connector

Connector type: 1x2 2-pin header, 1.25mm pitch
 Connector location: BATTERY1



Pin	Definition
1	BAT
2	GND

LVDS Panel Connector

Connector type: 1x40 40-pin header, 0.5mm pitch
 Connector location: LVDS



Pin	Definition	Pin	Definition
1	LVDS0_D3+	2	LVDS0_D3-
3	LVDS0_D2+	4	LVDS0_D2-
5	LVDS0_D1+	6	LVDS0_D1-
7	LVDS0_D0+	8	LVDS0_D0-
9	LVDS1_D3+	10	LVDS1_D3-
11	LVDS1_D2+	12	LVDS1_D2-
13	LVDS1_D1+	14	LVDS1_D1-
15	LVDS1_D0+	16	LVDS1_D0-
17	GND	18	+V_PANEL (3.3V or 5V)
19	+V_PANEL (3.3V or 5V)	20	+V_PANEL (3.3V or 5V)
21	GND	22	3.3V
23	GND	24	GND
25	GND	26	LVDS0_CLK+
27	LVDS0_CLK-	28	GND
29	GND	30	GND
31	SMBUS_CLK	32	Backlight Enable
33	Backlight Control	34	LVDS1_CLK+
35	LVDS1_CLK-	36	+12V
37	+12V	38	+12V
39	NC	40	SMBUS_DAT

Mini-PCIe Connector

Connector location: MINI_CARD

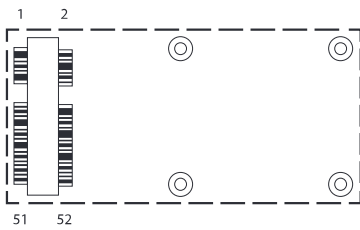

Pin	Definition	Pin	Definition
1	WAKE#	2	+3VSB
3	NC	4	GND
5	NC	6	+1.5V
7	NC	8	SIM_PWR
9	GND	10	SIM_DATA
11	REFCLK-	12	SIM_CLK
13	REFCLK+	14	SIM_RESET
15	GND	16	SIM_VPP
17	NC	18	GND
19	NC	20	WLAN_DISABLE#
21	GND	22	RESET#
23	PERn0	24	+3VSB
25	PERp0	26	GND

Pin	Definition	Pin	Definition
27	GND	28	+1.5V
29	GND	30	SMB_CLK
31	PETn0	32	SMB_DATA
33	PETp0	34	GND
35	GND	36	USB_D-
37	GND	38	USB_D+
39	+3VSB	40	GND
41	+3VSB	42	NC
43	GND	44	NC
45	NC	46	NC
47	NC	48	+1.5V
49	NC	50	GND
51	NC	52	+3VSB

M.2 Connector (M-Key)

Connector location: M2M

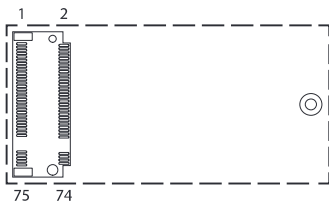

Pin	Definition	Pin	Definition
1	GND	2	+3VSB
3	GND	4	+3VSB
5	NC	6	NC
7	NC	8	NC
9	GND	10	M2M_LED#
11	NC	12	+3VSB
13	NC	14	+3VSB
15	GND	16	+3VSB
17	NC	18	+3VSB
19	NC	20	NC
21	GND	22	NC
23	NC	24	NC
25	NC	26	NC
27	GND	28	NC
29	NC	30	NC
31	NC	32	NC
33	GND	34	NC
35	NC	36	NC
37	NC	38	DEVSLP

Pin	Definition	Pin	Definition
39	GND	40	NC
41	SATA_RXP	42	NC
43	SATA_RXN	44	NC
45	GND	46	NC
47	SATA_TXN	48	NC
49	SATA_TXP	50	RESET#
51	GND	52	NC
53	NC	54	NC
55	NC	56	NC
57	GND	58	NC
67	NC	68	NC
69	NC	70	+3VSB
71	GND	72	+3VSB
73	GND	74	+3VSB
75	GND		

CHAPTER 3: SYSTEM SETUP

Removing the Chassis Cover



Prior to removing the chassis cover, make sure the unit's power is off and disconnected from the power sources to prevent electric shock or system damage.

1. The screws on the front, rear, bottom and screws for the COM port are used to secure the cover to the chassis. Remove these screws and put them in a safe place for later use.

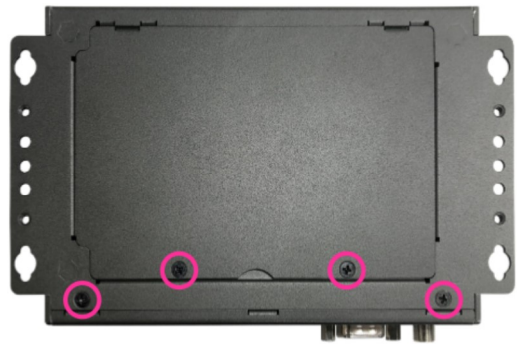

Installing a SO-DIMM Memory Module & M.2 M Key SSD Module (2242)

1. On the bottom of the system, loosen the screws on the bottom cover, and remove the cover from the chassis.

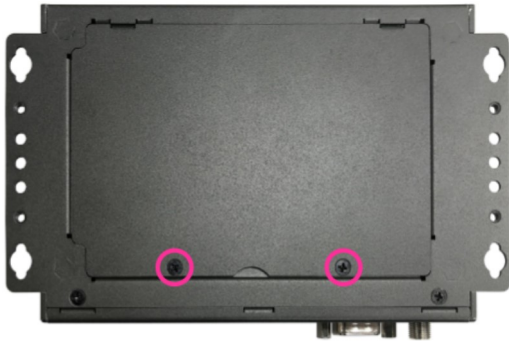

2. Insert the M.2 SSD module into the M.2 slot at a 45 degree angle until the gold-plated connector on the edge of the module completely disappears inside the slot. With the module fully inserted, tighten a screw into the mounting hole on the module to secure it.

Then, install a memory module into the SO-DIMM socket. Insert the module into the socket at an approximately 30 degree angle. Push the module down until the clips on both sides of the socket lock into position. The gold-plated connector on the edge of the module will almost completely disappear inside the socket.



SO-DIMM Socket

M.2 M Key Slot

Installing a Half-size Wi-Fi Module (Mini-PCIe Slot)

1. Install the mini-PCIe bracket to the mini-PCIe module

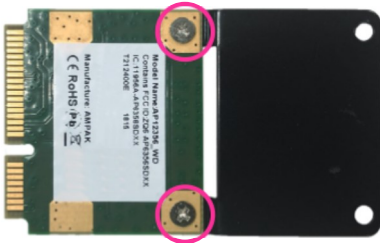

2. With the chassis cover removed, locate the mini-PCIe slot on the board. Insert the Wi-Fi module into the slot at a 45 degree angle until the gold-plated connector on the edge of the module completely disappears inside the slot. Tighten a screw into the mounting hole on the module to secure it.



3. Attach the RF cables onto the Wi-Fi module and remove the two antenna hole covers on the front panel. Then insert the antenna jack end of the cables through the antenna holes.

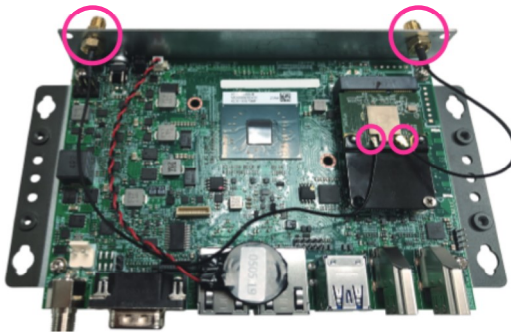

4. Insert the 2 rings (ring 1 then ring 2) into the Wi-Fi antenna jacks.

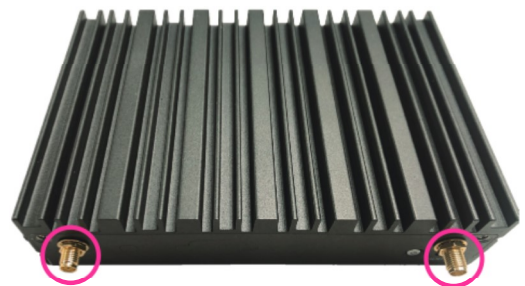

5. Connect the external antennas to the Wi-Fi antenna jacks.



Wall Mounting Instructions

To mount the system on to a wall or some other surface using the two mounting brackets, please follow the steps below.

1. Drill holes in the intended installation surface.
2. Align the mounting holes on the sides of the mounting brackets with the predrilled holes on the mounting surface.
3. Insert four retention screws, two in each bracket, to secure the system to the wall.

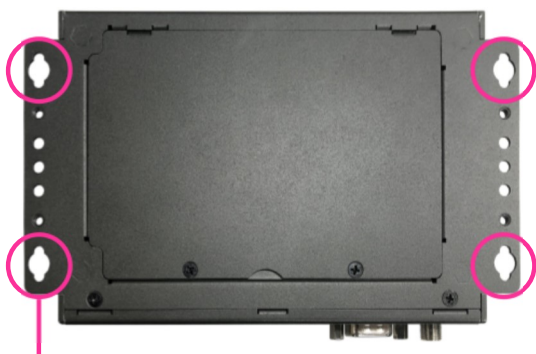

Fasten screws to mount the system to the wall



Specification of the wall mount screw:
Four Round Head Screw Long Fei: P6#32Tx 1/4/SW7*0.8
w/Spring+Flat Washer

CHAPTER 4: BIOS SETUP

This chapter describes how to use the BIOS setup program for Neu-X100. The BIOS screens provided in this chapter are for reference only and may change if the BIOS is updated in the future.

To check for the latest updates and revisions, visit the NEXCOM website at www.nexcom.com.tw.

About BIOS Setup

The BIOS (Basic Input and Output System) Setup program is a menu driven utility that enables you to make changes to the system configuration and tailor your system to suit your individual work needs. It is a ROM-based configuration utility that displays the system's configuration status and provides you with a tool to set system parameters.

These parameters are stored in non-volatile battery-backed-up CMOS RAM that saves this information even when the power is turned off. When the system is turned back on, the system is configured with the values found in CMOS.

With easy-to-use pull down menus, you can configure such items as:

- Hard drives, diskette drives, and peripherals
- Video display type and display options
- Password protection from unauthorized use
- Power management features

The settings made in the setup program affect how the computer performs. It is important, therefore, first to try to understand all the setup options, and second, to make settings appropriate for the way you use the computer.

When to Configure the BIOS

- This program should be executed under the following conditions:
- When changing the system configuration
- When a configuration error is detected by the system and you are prompted to make changes to the setup program
- When resetting the system clock
- When redefining the communication ports to prevent any conflicts
- When making changes to the Power Management configuration
- When changing the password or making other changes to the security setup

Normally, CMOS setup is needed when the system hardware is not consistent with the information contained in the CMOS RAM, whenever the CMOS RAM has lost power, or the system features need to be changed.