



NexAIoT Co., Ltd.

IoT Automation Solutions Business Group

Fan-less Computer

NISE 53

User Manual

CONTENTS

Preface

Copyright	iv
Disclaimer	iv
Acknowledgements	iv
Regulatory Compliance Statements	iv
Declaration of Conformity	iv
RoHS Compliance	v
Warranty and RMA	vi
Installation Recommendations	vii
Safety Information	viii
Safety Precautions	ix
Technical Support and Assistance	x
Conventions Used in this Manual	x
Global Service Contact Information	xi
Package Contents	xiii
Ordering Information	xiv

Chapter 1: Product Introduction

Overview	1
Front Panel	1
Rear	1
Hardware Specifications	2
Knowing Your NISE 53	4
Front Panel	4
Rear Panel	5
Mechanical Dimensions	6

Chapter 2: Jumpers and Connectors

Before You Begin	6
Precautions	6
Chassis Ground Isolation	7
Functional Ground Isolation	7
Jumper Settings	8
Locations of the Jumpers and Connectors for NISE 53	9
Connector Pin Definitions	10
External I/O Interfaces	10
COM Port	10
HDMI Port	11
Power Input Connector	11
Remote Power On/Off THR	12
LAN Ports	13
LAN Port	14
LED Indicators	15
Power Button	15
USB3.0 Connectors	16
USB2.0 Connectors	16
Internal Connectors - DIP Switch	17
Clear CMOS Select	17
Internal Connectors - Jumper	17
AT/ATX Mode Select	17
Internal Connectors - Header	18
RTC Battery	18



- M.2 Key B Connector 19
- M.2 Key B Connector 21
- Mini PCIe Connector 23
- COM Port Header 24
- UART4/I2C Header 24
- DE1 Connector 25
- DDR4 SO-DIMM Slot 26
- GPIO Header 29
- Flash BIOS Pin Header 29
- Reset Pin Header 30
- Nano SIM Connector 30

Chapter 3: System Setup

- Removing the Chassis Cover 25
- Installing a SO-DIMM Memory Module 26
- Installing a Installing a mini PCIe Card (Full-Size)..... 28
- Installing an M.2 Key B Module..... 30
 - Front accessible M.2 Key B 30
 - Internal M.2 Key B..... 32
- Installing a SIM Card 33
- Installing an Antenna 35

Chapter 4: BIOS Setup

- About BIOS Setup 36
- When to Configure the BIOS..... 36
- Default Configuration 37
- Entering Setup 37
- Legends 37
- BIOS Setup Utility 39
 - Main 39
 - Advanced 40
 - Chipset..... 48
 - Security 51
 - Boot..... 52
 - Save & Exit 53

Appendix A: GPI/O Programming Guide

Appendix B: Watchdog Timer Setting

Appendix C: Power Consumption

PREFACE

Copyright

This publication, including all photographs, illustrations and software, is protected under international copyright laws, with all rights reserved. No part of this manual may be reproduced, copied, translated or transmitted in any form or by any means without the prior written consent from NexAloT Co., Ltd.

Disclaimer

The information in this document is subject to change without prior notice and does not represent commitment from NexAloT Co., Ltd. However, users may update their knowledge of any product in use by constantly checking its manual posted on our website: <http://www.nexaiot.com>. NexAloT shall not be liable for direct, indirect, special, incidental, or consequential damages arising out of the use of any product, nor for any infringements upon the rights of third parties, which may result from such use. Any implied warranties of merchantability or fitness for any particular purpose is also disclaimed.

Acknowledgements

NISE 53 is a trademark of NexAloT Co., Ltd. All other product names mentioned herein are registered trademarks of their respective owners.

Regulatory Compliance Statements

This section provides the FCC compliance statement for Class A devices and describes how to keep the system CE compliant.

Declaration of Conformity

FCC

This equipment has been tested and verified to comply with the limits for a Class A digital device, pursuant to Part 15 of FCC Rules. These limits are designed to provide reasonable protection against harmful interference when the equipment is operated in a commercial environment. This equipment generates, uses, and can radiate radio frequency energy and, if not installed and used in accordance with the instructions, may cause harmful interference to radio communications. Operation of this equipment in a residential area (domestic environment) is likely to cause harmful interference, in which case the user will be required to correct the interference (take adequate measures) at their own expense.

CE

The product(s) described in this manual complies with all applicable European Union (CE) directives if it has a CE marking. For computer systems to remain CE compliant, only CE-compliant parts may be used. Maintaining CE compliance also requires proper cable and cabling techniques.

RoHS Compliance



NexAloT RoHS Environmental Policy and Status Update

NexAloT is a global citizen for building the digital infrastructure. We are committed to providing green products and services, which are compliant with European Union RoHS (Restriction on Use of Hazardous Substance in Electronic Equipment) directive 2011/65/EU, to be your trusted green partner and to protect our environment.

RoHS restricts the use of Lead (Pb) < 0.1% or 1,000ppm, Mercury (Hg) < 0.1% or 1,000ppm, Cadmium (Cd) < 0.01% or 100ppm, Hexavalent Chromium (Cr6+) < 0.1% or 1,000ppm, Polybrominated biphenyls (PBB) < 0.1% or 1,000ppm, and Polybrominated diphenyl Ethers (PBDE) < 0.1% or 1,000ppm.

In order to meet the RoHS compliant directives, NexAloT has established an engineering and manufacturing task force to implement the introduction of green products. The task force will ensure that we follow the standard NexAloT development procedure and that all the new RoHS components and new manufacturing processes maintain the highest industry quality levels for which NexAloT are renowned.

The model selection criteria will be based on market demand. Vendors and suppliers will ensure that all designed components will be RoHS compliant.

How to recognize NexAloT RoHS Products?

For existing products where there are non-RoHS and RoHS versions, the suffix "(LF)" will be added to the compliant product name.

All new product models launched after January 2013 will be RoHS compliant. They will use the usual NexAloT naming convention.

Warranty and RMA

NexAloT Warranty Period

NexAloT manufactures products that are new or equivalent to new in accordance with industry standard. NexAloT warrants that products will be free from defect in material and workmanship for 2 years, beginning on the date of invoice by NexAloT.

NexAloT Return Merchandise Authorization (RMA)

- Customers shall enclose the “NexAloT RMA Service Form” with the returned packages.
- Customers must collect all the information about the problems encountered and note anything abnormal or, print out any on-screen messages, and describe the problems on the “NexAloT RMA Service Form” for the RMA number apply process.
- Customers can send back the faulty products with or without accessories (manuals, cable, etc.) and any components from the card, such as CPU and RAM. If the components were suspected as part of the problems, please note clearly which components are included. Otherwise, NexAloT is not responsible for the devices/parts.
- Customers are responsible for the safe packaging of defective products, making sure it is durable enough to be resistant against further damage and deterioration during transportation. In case of damages occurred during transportation, the repair is treated as “Out of Warranty.”
- Any products returned by NexAloT to other locations besides the customers’ site will bear an extra charge and will be billed to the customer.

Repair Service Charges for Out-of-Warranty Products

NexAloT will charge for out-of-warranty products in two categories, one is basic diagnostic fee and another is component (product) fee.

System Level

- Component fee: NexAloT will only charge for main components such as SMD chip, BGA chip, etc. Passive components will be repaired for free, ex: resistor, capacitor.
- Items will be replaced with NexAloT products if the original one cannot be repaired. Ex: motherboard, power supply, etc.
- Replace with 3rd party products if needed.
- If RMA goods can not be repaired, NexAloT will return it to the customer without any charge.

Board Level

- Component fee: NexAloT will only charge for main components, such as SMD chip, BGA chip, etc. Passive components will be repaired for free, ex: resistors, capacitors.
- If RMA goods can not be repaired, NexAloT will return it to the customer without any charge.

Warnings

Read and adhere to all warnings, cautions, and notices in this guide and the documentation supplied with the chassis, power supply, and accessory modules. If the instructions for the chassis and power supply are inconsistent with these instructions or the instructions for accessory modules, contact the supplier to find out how you can ensure that your computer meets safety and regulatory requirements.

Cautions

Electrostatic discharge (ESD) can damage system components. Do the described procedures only at an ESD workstation. If no such station is available, you can provide some ESD protection by wearing an antistatic wrist strap and attaching it to a metal part of the computer chassis.

Installation Recommendations

Ensure you have a stable, clean working environment. Dust and dirt can get into components and cause a malfunction. Use containers to keep small components separated.

Adequate lighting and proper tools can prevent you from accidentally damaging the internal components. Most of the procedures that follow require only a few simple tools, including the following:

- A Philips screwdriver
- A flat-tipped screwdriver
- A grounding strap
- An anti-static pad

Using your fingers can disconnect most of the connections. It is recommended that you do not use needle-nose pliers to disconnect connections as these can damage the soft metal or plastic parts of the connectors.

Safety Information

Before installing and using the device, note the following precautions:

- Read all instructions carefully.
- Do not place the unit on an unstable surface, cart, or stand.
- Follow all warnings and cautions in this manual.
- When replacing parts, ensure that your service technician uses parts specified by the manufacturer.
- Avoid using the system near water, in direct sunlight, or near a heating device.
- The load of the system unit does not solely rely for support from the rackmounts located on the sides. Firm support from the bottom is highly necessary in order to provide balance stability.
- The computer is provided with a battery-powered real-time clock circuit. There is a danger of explosion if battery is incorrectly replaced. Replace only with the same or equivalent type recommended by the manufacturer. Discard used batteries according to the manufacturer's instructions.
- This product is intended to be supplied by an approved power adapter, rated 12Vdc, 5A or 24Vdc, 2.5A minimum and Tma 55 degree Celsius. If further assistance is needed, please contact NexAIoT for further information.



Danger of explosion if battery is incorrectly replaced. Replace with the same or equivalent type recommended by the manufacturer. Discard used batteries according to the manufacturer's instructions.



ATTENTION
IL Y A RISQUE D'EXPLOSION SI LA BATTERIE EST REMPLACÉE
PAR UNE BATTERIE DE TYPE INCORRECT.
METTRE AU REBUT LES BATTERIES USAGÉES
CONFORMÉMENT AUX INSTRUCTIONS.

Safety Precautions

1. Read these safety instructions carefully.
2. Keep this User Manual for later reference.
3. Disconnect this equipment from any AC outlet before cleaning. Use a damp cloth. Do not use liquid or spray detergents for cleaning.
4. For plug-in equipment, the power outlet socket must be located near the equipment and must be easily accessible.
5. Keep this equipment away from humidity.
6. Put this equipment on a stable surface during installation. Dropping it or letting it fall may cause damage.
7. The openings on the enclosure are for air convection to protect the equipment from overheating. **DO NOT COVER THE OPENINGS.**
8. Make sure the voltage of the power source is correct before connecting the equipment to the power outlet.
9. Place the power cord in a way so that people will not step on it. Do not place anything on top of the power cord. Use a power cord that has been approved for use with the product and that it matches the voltage and current marked on the product's electrical range label. The voltage and current rating of the cord must be greater than the voltage and current rating marked on the product.
10. All cautions and warnings on the equipment should be noted.
11. If the equipment is not used for a long time, disconnect it from the power source to avoid damage by transient overvoltage.
12. Never pour any liquid into an opening. This may cause fire or electrical shock.
13. This equipment is not suitable for use in locations where children are likely to be present.
14. Ensure to connect the power cord to a socket-outlet with earthing connection.
15. Never open the equipment. For safety reasons, the equipment should be opened only by qualified service personnel.
16. If one of the following situations arises, get the equipment checked by service personnel:
 - a. The power cord or plug is damaged.
 - b. Liquid has penetrated into the equipment.
 - c. The equipment has been exposed to moisture.
 - d. The equipment does not work well, or you cannot get it to work according to the user's manual.
 - e. The equipment has been dropped and damaged.
 - f. The equipment has obvious signs of breakage.
17. Do not place heavy objects on the equipment.
18. The unit uses a three-wire ground cable which is equipped with a third pin to ground the unit and prevent electric shock. Do not defeat the purpose of this pin. If your outlet does not support this kind of plug, contact your electrician to replace your obsolete outlet.
19. **CAUTION: DANGER OF EXPLOSION IF BATTERY IS INCORRECTLY REPLACED. REPLACE ONLY WITH THE SAME OR EQUIVALENT TYPE RECOMMENDED BY THE MANUFACTURER. DISCARD USED BATTERIES ACCORDING TO THE MANUFACTURER'S INSTRUCTIONS.**

Technical Support and Assistance

1. For the most updated information of NexAloT products, visit NexAloT's website at www.nexaiot.com.
2. For technical issues that require contacting our technical support team or sales representative, please have the following information ready before calling:
 - Product name and serial number
 - Detailed information of the peripheral devices
 - Detailed information of the installed software (operating system, version, application software, etc.)
 - A complete description of the problem
 - The exact wordings of the error messages

Warning!

1. Handling the unit: carry the unit with both hands and handle it with care.
2. Maintenance: to keep the unit clean, use only approved cleaning products or clean with a dry cloth.

Conventions Used in this Manual



Warning:

Information about certain situations, which if not observed, can cause personal injury. This will prevent injury to yourself when performing a task.



Caution:

Information to avoid damaging components or losing data.



Note:

Provides additional information to complete a task easily.

Global Service Contact Information

Headquarters

NEXCOM International Co., Ltd.

9F, No. 920, Zhongzheng Rd.,
Zhonghe District, New Taipei City, 23586,
Taiwan, R.O.C.
Tel: +886-2-8226-7786
Fax: +886-2-8226-7782
www.nexcom.com

Asia

Taiwan

NexAIoT Headquarters

Industry 4.0 and Cloud Services

13F, No.922, Zhongzheng Rd.,
Zhonghe District, New Taipei City,
23586, Taiwan, R.O.C.
Tel: +886-2-8226-7796
Fax: +886-2-8226-7926
Email: jacobhuang@nexaiot.com
www.nexaiot.com

NexAIoT Co., Ltd.

Taichung Office

16F, No.250, Sec. 2, Chongde Rd.,
Beitun District,
Taichung City, 406, Taiwan, R.O.C.
Tel: +886-4-2249-1179
Fax: +886-4-2249-1172
Email: jacobhuang@nexaiot.com
www.nexaiot.com

NexCOBOT Taiwan Co., Ltd.

13F, No.916, Zhongzheng Rd.,
Zhonghe District,
New Taipei City, 23586, Taiwan, R.O.C.
Tel: +886-2-8226-7786
Fax: +886-2-8226-7926
Email: jennyshern@nexcobot.com
www.nexcobot.com

GreenBase Technology Corp.

13F, No.922, Zhongzheng Rd.,
Zhonghe District,
New Taipei City, 23586, Taiwan, R.O.C.
Tel: +886-2-8226-7786
Fax: +886-2-8226-7900
Email: vivianlin@nexcom.com.tw
www.nexcom.com.tw

DivioTec Inc.

19F-1A, No.97, Sec.4, ChongXin Rd.,
Sanhong District,
New Taipei City, 24161, Taiwan, R.O.C.
Tel: +886-2-8976-3077
Email: sales@diviotec.com
www.diviotec.com

AIoT Cloud Corp.

13F, No.922, Zhongzheng Rd.,
Zhonghe District,
New Taipei City, 23586, Taiwan, R.O.C.
Tel: +886-2-8226-7786
Fax: +886-2-8226-7782
Email: alantsai@aiotcloud.net
www.aiotcloud.dev

EMBUX Technology Co., Ltd.

13F, No.916, Zhongzheng Rd.,
Zhonghe District,
New Taipei City, 23586, Taiwan, R.O.C.
Tel: +886-2-8226-7786
Fax: +886-2-8226-7782
Email: info@embux.com
www.embux.com

TMR Technology Corp.

13F, No.916, Zhongzheng Rd.,
Zhonghe District,
New Taipei City, 23586, Taiwan, R.O.C.
Tel: +886-2-8226-7786
Fax: +886-2-8226-7782
Email: services@tmrtek.com
www.tmrtek.com

China

NEXSEC Incorporated

201, Floor 2, Unit 2, Building 15, Yard 3,
Gaolizhang Road, Haidian District,
Beijing, 100094, China
Tel: +86-10-5704-2680
Fax: +86-10-5704-2681
Email: marketing@nexsec.cn
www.nexcom.cn

NEXCOM Shanghai

Room 406-407, Building C, No 154, Lane 953,
Jianchuan Road, Minhang District,
Shanghai, 201108, China
Tel: +86-21-5278-5868
Fax: +86-21-3251-6358
Email: sales@nexcom.cn
www.nexcom.cn

NEXCOM Surveillance Technology Corp.

Floor 8, Building B3, Xiufeng Industrial Zone,
GanKeng Community, Buji Street,
LongGang District,
ShenZhen, 518112, China
Tel: +86-755-8364-7768
Fax: +86-755-8364-7738
Email: steveyang@nexcom.com.tw
www.nexcom.cn

NEXGOL Chongqing

1st Building No.999,
Star Boulevard, Yongchuan Dist,
Chongqing City, 402160, China
Tel: +86-23-4960-9080
Fax: +86-23-4966-5855
Email: sales@nexgol.com.cn
www.nexcom.cn

Beijing NexGemo Technology Co.,Ltd.

Room 205, No.1, Fazhan Rd.,
Beijing International Information Industry Base,
Changping District,
Beijing, 102206, China
Tel: +86-10-8072-2025
Fax: +86-10-8072-2022
Email: sales@nexgemo.cn
www.nexgemo.cn

Japan

NEXCOM Japan

9F, Tamachi Hara Bldg.,
4-11-5, Shiba Minato-ku,
Tokyo, 108-0014, Japan
Tel: +81-3-5419-7830
Fax: +81-3-5419-7832
Email: sales@nexcom-jp.com
www.nexcom-jp.com

America

USA NEXCOM USA

46665 Fremont Blvd.,
Fremont CA 94538, USA
Tel: +1-510-656-2248
Fax: +1-510-656-2158
Email: sales@nexcom.com
www.nexcomusa.com

Package Contents

Before continuing, verify that the package that you received is complete. Your NISE 53 package should have all the items listed in the following table.

Item	Part Number	Description	Qty
1	7400060054X00	POWER ADAPTER LITEON:HA-1600-24E5	1
2	5061711760X00	MINI PCI-E BRACKET FOR NISE106 SERIES VER:A ASDA	1
3	50311F0330X00	ROUND HEAD SCREW LONG FEI:P2x3 ISO+NYLON	1
4	50311F0295X00	FLAT HEAD SCREW LONG FEI:F2x4 NYLOK NIGP	2
5	50344C0379X00	COPPER POST FOR NISE53 SERIES VER:A LONG FEI	1
6	50311F0144X00	I HEAD SCREW LONG FEI:	1
7	5061600245X00	WASHER KANGYANG:TW-320-01	6
8	5061500239X00	DIAMETER HOLE PLUGS KANG YANG:MHD-16-01	3
9	5060200675X00	THERMAL PAD E-LIN	2
10	5060200678X00	THERMAL PAD E-LIN	1
11	50333P0038X00	WASHER KANGYANG:WS6-3.2-1A(B)	2
12	50311F0326X00	FLAT HEAD SCREW LONG FEI:F3x5 NYLOK NI+HEAT TREATMENT	1
13	4NCPM00203X00	TERMINAL BLOCKS 2P PHOENIX CONTACT:1803578	1

Ordering Information

The following information below provides ordering information for NISE 53.

NISE 53-E01 (P/N: 10J00005300X0)

- Intel® Celeron® J6413 processor quad core fanless system with 60W AC to DC power adapter, w/o power cord

NISE 53-E02 (P/N: 10J00005301X0)

- Intel Atom® x6211E processor dual core fanless system with 60W AC to DC power adapter, w/o power cord

CHAPTER 1: PRODUCT INTRODUCTION

Overview

Front Panel



Rear



Key Features

- Onboard Intel® Celeron® processor J6413, 1.8 GHz, or Atom® processor x6211E, 1.3 Ghz
- 3 x HDMI (triple displays)
- 2 x USB 3.0, 2 x USB 2.0
- 1 x RS232/485, 1 x RS232/485 with auto flow control
- 3 x GbE LAN ports
- 1 x Full-size mini-PCIe
- 1 x Front accessible M.2 Key B
- 1 x Internal M.2 Key B
- Support operating temperature from -10°C to 60°C
- Support +12V/24V DC input; support ATX power mode

Hardware Specifications

CPU Support

- Onboard Intel® Celeron® J6413 processor, 1.8 GHz
- Onboard Intel Atom® x6211E processor, 1.3 Ghz

Main Memory

- 1 x DDR4 3200 unbuffered non-ECC SO-DIMM socket, support up to 16 GB

Display Option

- Support triple independent displays
 - 3 x HDMI, resolution 1920 x 1080 @60Hz

I/O Interface - Front

- ATX power on/off switch
- 3 x HDMI
- 1 x Intel® I226V GbE LAN port
- 2 x Marvell SOC PHY Gbe LAN ports
- 2 x USB 2.0 (900mA per each)
- 1 x 2-pin remote power on/off switch

I/O Interface - Rear

- 2 x USB 3.1 ports (500mA per each)
- 2 x DB9 for COM1 & COM2
 - COM1: RS232/485, only support TX/RX/CTS/RTS, with auto flow control
 - COM2: RS232/485, only support TX/RX/CTS/RTS
- 1 x 3-pin terminal block, support +12/+24V DC input

I/O Interface - Internal

- 4 x GPI and 4 x GPO (programmable to GPI or GPO)

Storage Device

- 1 x Optional onboard 32 GB EMMC

TPM

- TPM 2.0

Expansion Slot

- 1 x Internal nano SIM card holder
- 1 x Full-size mini-PCIe for Wi-Fi/BT/4G LTE/storage
- 1 x Front access M.2 Key B for 4G LTE/ PCIe& SATA storage
- 1 x Internal M.2 Key B for 5G/4G LTE

Power Requirements

- AT/ATX power mode (default: ATX power mode)
- Power input: +12/+24V DC in

Supported OS

- Windows 11
- Windows® 10 Enterprise 64 bit
- Linux Kernel version 4.19

Dimensions

- 186mm (W) x 150mm (D) x 26mm (H)

Construction

- Metal chassis with fanless design

Environment

- Operating temperature
 - Ambient with air flow: -10°C to 60°C (according to IEC60068-2-1, IEC60068-2-2, IEC60068-2-14)
- Storage temperature: -40°C to 85°C
- Relative humidity: 10% to 90% (non-condensing)
- Shock protection
 - M.2/mSATA: 50G @ wall mount, half sine, 11ms(operation), IEC60068-2-27
- Vibration protection with M.2/ mSATA condition
 - Random: 2Grms @ 5~500 Hz, IEC60068-2-64
 - Sinusoidal: 2Grms @ 5~500 Hz, IEC60068-2-6

Certifications

- CE
- FCC Class A

Knowing Your NISE 53

Front Panel



- 1 Antenna Hole**
Install the external antennas.
- 2 Power Switch**
Press to power-on or power-off the system.
- 3 LAN Ports**
Connect the system to a local area network.
- 4 LED Indicators**
Indicate the hard drive and GPIO (programmable) activity of the system.
- 5 USB 2.0**
Connect the system with USB 2.0/1.1 devices.
- 6 HDMI Ports**
Connect with HDMI interface displays.
- 7 Remote On/Off Switch**
Connect a remote to power on/off the system.

Rear Panel



- 8 DC Input***
Plugs a DC power cord. (+12/+24V DC input)
- 9 COM1**
RS232/485 supports only TX/RX/CTS/RTS, with auto flow control.
- 10 COM2**
RS232/485 supports only TX/RX/CTS/RTS.
- 11 USB 3.1**
Connect the system with USB 3.0/2.0 devices.
- 12 M.2 Slot**
Connect the system with an M.2 device (M.2 Key B 2242, PCIe x2).
- 1 Antenna Hole**
Install the external antennas.



Use the provided power adapter only from the package, and connect it to the DC side (3-pin phoenix connector) of the system before connecting it to the AC side.

Mechanical Dimensions

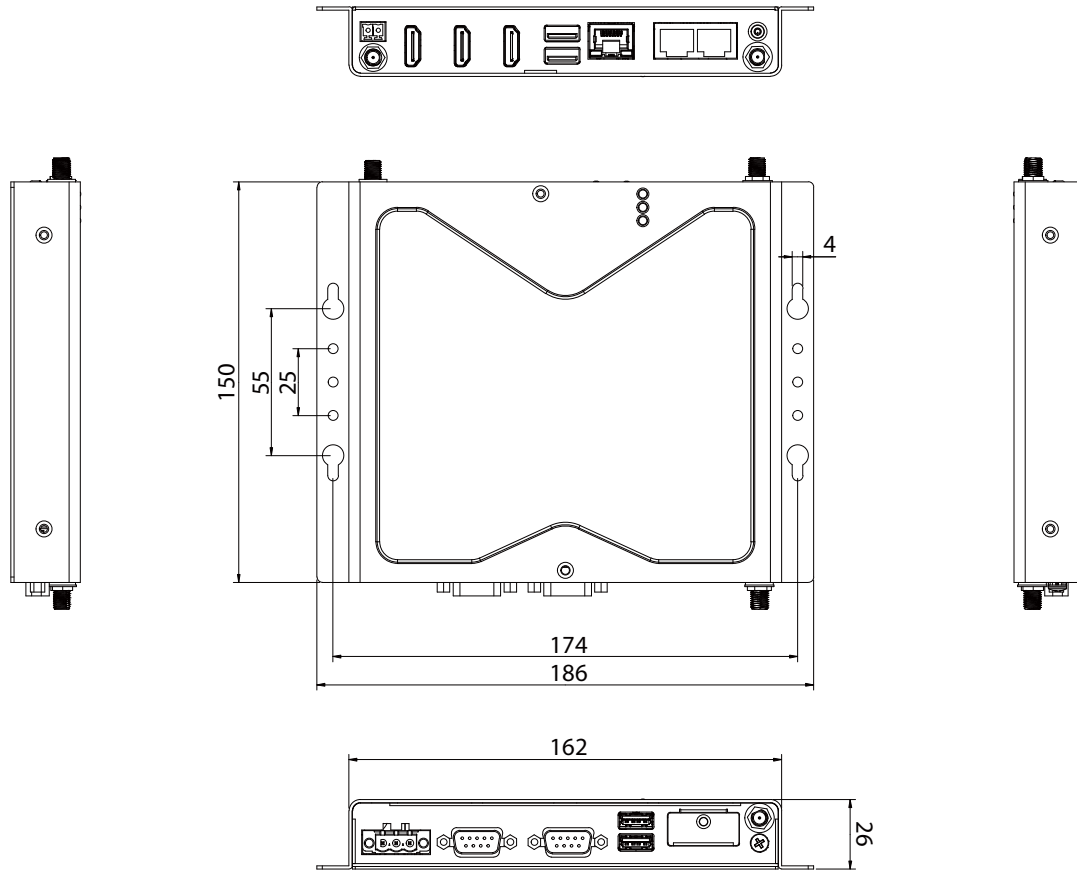

CHAPTER 2: JUMPERS AND CONNECTORS

This chapter describes how to set the jumpers and connectors on the NISE 53 motherboard.

Before You Begin

- Ensure you have a stable, clean working environment. Dust and dirt can get into components and cause a malfunction. Use containers to keep small components separated.
- Adequate lighting and proper tools can prevent you from accidentally damaging the internal components. Most of the procedures that follow require only a few simple tools, including the following:
 - A Philips screwdriver
 - A flat-tipped screwdriver
 - A set of jewelers screwdrivers
 - A grounding strap
 - An anti-static pad
- Using your fingers can disconnect most of the connections. It is recommended that you do not use needle-nosed pliers to disconnect connections as these can damage the soft metal or plastic parts of the connectors.
- Before working on internal components, make sure that the power is off. Ground yourself before touching any internal components, by touching a metal object. Static electricity can damage many of the electronic components. Humid environments tend to have less static electricity than

dry environments. A grounding strap is warranted whenever danger of static electricity exists.

Precautions

Computer components and electronic circuit boards can be damaged by discharges of static electricity. Working on computers that are still connected to a power supply can be extremely dangerous.

Follow the guidelines below to avoid damage to your computer or yourself:

- Always disconnect the unit from the power outlet whenever you are working inside the case.
- If possible, wear a grounded wrist strap when you are working inside the computer case. Alternatively, discharge any static electricity by touching the bare metal chassis of the unit case, or the bare metal body of any other grounded appliance.
- Hold electronic circuit boards by the edges only. Do not touch the components on the board unless it is necessary to do so. Don't flex or stress the circuit board.
- Leave all components inside the static-proof packaging that they shipped with until they are ready for installation.
- Use correct screws and do not over tighten screws.

Chassis Ground Isolation

Before working with the system, follow the instructions below to ensure the chassis is grounded:

1. Attach a cable lug on the protective conductor screw.
2. Connect the protective conductor screw to a protective grounding connection in your installation site.

The protective conductor screw (round head screw) is located on the bottom right corner of the rear panel as shown below.



 Specification of the round head screw:
Round Head Screw Long Fei: p6#32T Nylok P6#32T Outer Teeth
Washer Nylok

Functional Ground Isolation

When connecting power to the terminal block connector on the system, ensure the ground pin (marked in red below) on the connector is connected to a grounding stripe.



 Use the provided power adapter only from the package, and connect it to the DC side (3-pin phoenix connector) of the system before connecting it to the AC side.

Jumper Settings

A jumper is the simplest kind of electric switch. It consists of two metal pins and a cap. When setting the jumpers, ensure that the jumper caps are placed on the correct pins. When the jumper cap is placed on both pins, the jumper is short. If you remove the jumper cap, or place the jumper cap on just one pin, the jumper is open.

Refer to the illustrations below for examples of what the 2-pin and 3-pin jumpers look like when they are short (on) and open (off).

Two-Pin Jumpers: Open (Left) and Short (Right)

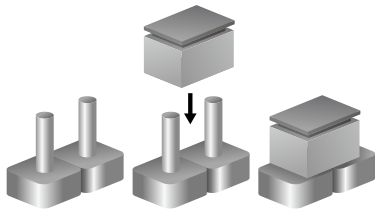

Three-Pin Jumpers: Pins 1 and 2 are Short

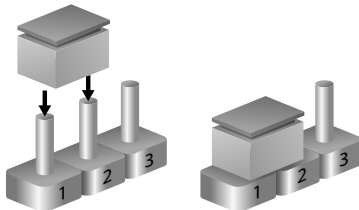

Locations of the Jumpers and Connectors for NISE 53

The following figures show the motherboard used in the NISE 53 series, and indicate the locations of the jumpers and connectors. Refer to this chapter for detailed pin settings and definitions of the connectors marked in pink on this figure.

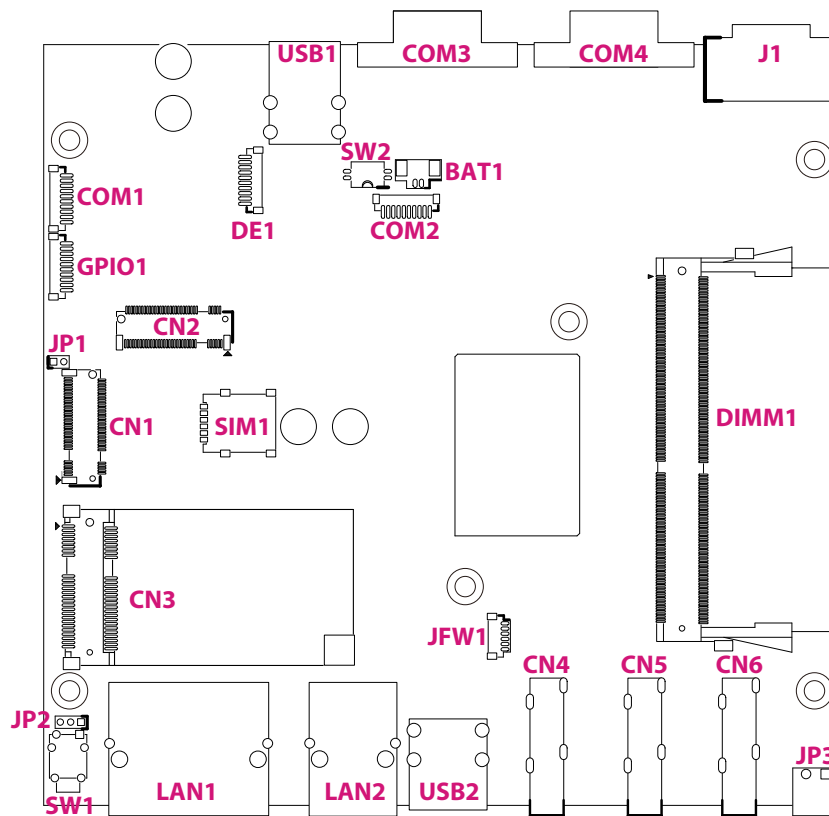

Connector Pin Definitions

External I/O Interfaces

COM Port

Connector location: COM3, COM4

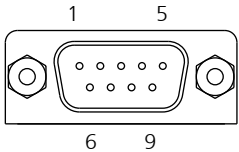

RS232 Pin Definition

Pin	Definition	Pin	Definition
1	NC	6	NC
2	COM RXD	7	COM RTS
3	COM TXD	8	COM CTS
4	NC	9	NC
5	GND	10	
MH1	CHASIS_GND	MH2	CHASIS_GND

RS485 Half Duplex

Pin	Definition	Pin	Definition
1	NC	6	NC
2	NC	7	RS485 DATA-
3	RS485 DATA+	8	NC
4	NC	9	NC
5	GND	10	
MH1	CHASIS_GND	MH2	CHASIS_GND

RS485 Full Duplex

Pin	Definition	Pin	Definition
1	NC	6	NC
2	RS485 RX+	7	RS485 TX-
3	RS485 TX+	8	RS485 RX-
4	NC	9	NC
5	GND	10	
MH1	CHASIS_GND	MH2	CHASIS_GND

HDMI Port

Connector location: CN4, CN5, CN6

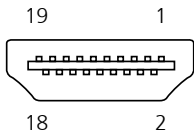

Pin	Definition	Pin	Definition
1	HDMI_D2+	11	AGND
2	AGND	12	HDMI_CLK-
3	HDMI_D2-	13	N/C
4	HDMI_D1+	14	N/C
5	AGND	15	DDC_SCL
6	HDMI_D1-	16	DDC_SDA
7	HDMI_D0+	17	GND
8	AGND	18	+5V
9	HDMI_D0-	19	HDMI_HPD
10	HDMI_CLK+		
MH1	CHASIS_GND	MH2	CHASIS_GND
MH3	CHASIS_GND	MH4	CHASIS_GND

Power Input Connector

Connector location: J1

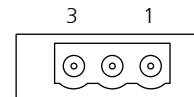

Pin	Definition
1	VCCIN
2	GND
3	Chassis GND

Remote Power On/Off THR

Connector location: JP3



Pin	Definition
1	GND
2	PWRBTN#_J

LAN Ports

Connector location: LAN1

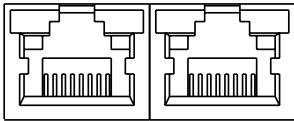

A1 A8 B1 B14

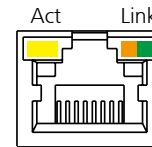

Pin	Definition	Pin	Definition
A1	LAN1MDI0P	B1	LAN2MDI0P
A2	LAN1MDI0N	B2	LAN2MDI0N
A3	LAN1MDI1P	B3	LAN2MDI1P
A4	LAN1MDI1N	B4	LAN2MDI1N
A5	LAN1TVCC1	B5	LAN2TVCC1
A6	GND	B6	GND
A7	LAN1MDI2P	B7	LAN2MDI2P
A8	LAN1MDI2N	B8	LAN2MDI2N
A9	LAN1MDI3P	B9	LAN2MDI3P
A10	LAN1MDI3N	B10	LAN2MDI3N
A11	LAN1LINK1000L	B11	LAN2LINK1000L
A12	LAN1LINK100L1	B12	LAN2LINK100L1
A13	LAN1LEDACTL	B13	LAN2LEDACTL
A14	LAN1LEDPWR	B14	LAN2LEDPWR
NH1	NC	NH2	NC
MH1	CHASIS_GND	MH2	CHASIS_GND

Link Speed	Act. LED (Left)	Link LED (Right)
10/100/1000	Blinking Yellow	Always On Green

LAN Port

Connector location: LAN2

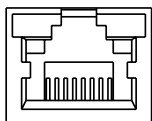

1 8

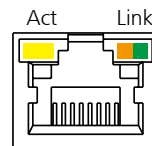

Pin	Definition	Pin	Definition
1	RGM1MDIP[0]	10	RGM1MDIN[3]
2	RGM1MDIN[0]	11	RGM1LED0
3	RGM1MDIP[1]	12	RGM1LED0100
4	RGM1MDIN[1]	13	RGM1LED1
5	RGM1VCC1	14	RGM1LED1ACT
6	GND	NH1	NC
7	RGM1MDIP[2]	NH2	NC
8	RGM1MDIN[2]	MH1	CHASIS_GND
9	RGM1MDIP[3]	MH2	CHASIS_GND

Link Speed	Act. LED (Left)	Link LED (Right)
1000	Blinking Yellow	Always On Green
100		Always On Orange
10		Off

LED Indicators

Connector location: LED1, LED2, LED3

LED1 SATA

LED2 GPOLED1

LED3 GPOLED2

	Pin	Definition	Pin	Definition
LED1	A	330 ohm pull up 3.3V	C	SATALED
LED2	A	330 ohm pull up 3.3V	C	GPOLED1
LED3	A	330 ohm pull up 3.3V	C	GPOLED2

Power Button

Connector location: SW1

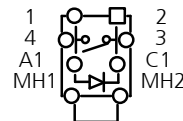

Pin	Definition	Pin	Definition
1	GND	2	ATX_PBT
4	GND	3	ATX_PBT
A1	PWRLED_N	C1	N16937976
MH1	NC	MH2	NC

USB3.0 Connectors

Connector location: USB1

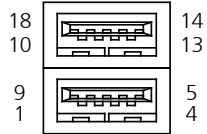

Pin	Definition	Pin	Definition
1	+5VSB	10	+5V
2	USB2_N2	11	USB2_N3
3	USB2_P2	12	USB2_P3
4	GND	13	GND
5	USB3_RXN0	14	USB3_RXN1
6	USB3_RXP0	15	USB3_RXP1
7	GND	16	GND
8	USB3_TXN0	17	USB3_TXN1
9	USB3_TXP0	18	USB3_TXP1
MH1	CHASIS_GND	MH2	CHASIS_GND
MH3	CHASIS_GND	MH4	CHASIS_GND

USB2.0 Connectors

Connector location: USB2

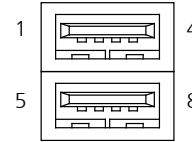

Pin	Definition	Pin	Definition
1	+5VSB	5	+5V
2	USB2_N0	6	USB2_N1
3	USB2_P0	7	USB2_P1
4	GND	8	GND
MH1	CHASIS_GND	MH2	CHASIS_GND
MH3	CHASIS_GND	MH4	CHASIS_GND

Internal Connectors - DIP Switch

Clear CMOS Select

Connector location: SW2



Pin	Definition
1	I_RTCRSTL
2	I_RTCTESTL
3	GND
4	GND

Pin	Description
1-4	Status
2-3	
On	Clean CMOS
Off	Normal (Default)

Internal Connectors - Jumper

AT/ATX Mode Select

Connector location: JP2

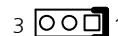

Pin	Description
1	AT_PWRBT#
2	PBT_PU
3	ATX_PBT

Pin	Description
1-2 On	ATX mode (default)
2-3 On	AT mode



ATX Mode: Press the power button to switch on when power is available.

AT Mode: Direct power on when power is available.

Internal Connectors - Header

RTC Battery

Connector location: BAT1



Pin	Definition	Pin	Definition
1	GND	2	3V_BAT1
MH1	GND	MH2	GND

M.2 Key B Connector

Connector location: CN1

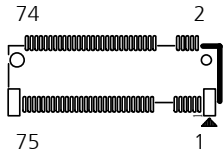

Pin	Definition	Pin	Definition
1	M2BCONFIG3	2	M2LTEPWR
3	GND	4	M2LTEPWR
5	GND	6	S_GP42
7	I_USB2P0	8	S_GP43
9	I_USB2N0	10	NC
11	M2REFCLK-	12	
13		14	
15		16	
17		18	
19		20	NC

Pin	Definition	Pin	Definition
21	M2BCONFIG0	22	NC
23	LTEPEWAKE2	24	NC
25	NC	26	NC
27	GND	28	NC
29	I_USB3RXN2	30	UIM_RESET
31	I_USB3RXP2	32	UIM_CLK
33	GND	34	UIM_DATA
35	I_USB3TXN2	36	UIM_PWR
37	I_USB3TXP2	38	NC
39	GND	40	NC

Pin	Definition	Pin	Definition
41	I_PCIERXN4	42	NC
43	I_PCIERXP4	44	NC
45	GND	46	NC
47	I_PCIETXN4	48	NC
49	I_PCIETXP4	50	LTEPERSTL
51	GND	52	NC
53	M2REFCLKN	54	LTEPEWAKE1
55	M2REFCLKP	56	NC
57	GND	58	NC
59	NC	60	NC

Pin	Definition	Pin	Definition
61	NC	62	NC
63	NC	64	NC
65	NC	66	NC
67	M2LTERSTL	68	M2B_SUSCLK
69	M2BCONFIG1	70	M2LTEPWR
71	GND	72	M2LTEPWR
73	GND	74	M2LTEPWR
75	M2BCONFIG2		
MH1	GND	MH2	GND
NH1	NC	NH2	NC

M.2 Key B Connector

Connector location: CN2



Pin	Definition	Pin	Definition
1	M2BCONFIG3	2	M2LTEPWR
3	GND	4	M2LTEPWR
5	GND	6	S_GP42
7	I_USB2P2	8	S_GP43
9	I_USB2N2	10	NC
11	M2REFCLK-	12	
13		14	
15		16	
17		18	
19		20	NC

Pin	Definition	Pin	Definition
21	M2BCONFIG0	22	NC
23	LTEPEWAKE2	24	NC
25	NC	26	NC
27	GND	28	NC
29	I_PCIERXN3	30	UIM_RESET
31	I_PCIEXP3	32	UIM_CLK
33	GND	34	UIM_DATA
35	I_PCIETXN3	36	UIM_PWR
37	I_PCIEXP3	38	NC
39	GND	40	NC

Pin	Definition	Pin	Definition
41	PCIESATARP2	42	NC
43	PCIESATARN2	44	NC
45	GND	46	NC
47	PCIESATATN2	48	NC
49	PCIESATATP2	50	LTEPERSTL
51	GND	52	NC
53	M2REFCLKN	54	LTEPEWAKE1
55	M2REFCLKP	56	NC
57	GND	58	NC
59	NC	60	NC

Pin	Definition	Pin	Definition
61	NC	62	NC
63	NC	64	NC
65	NC	66	NC
67	M2LTERSTL	68	M2B_SUSCLK
69	M2BCONFIG1	70	M2LTEPWR
71	GND	72	M2LTEPWR
73	GND	74	M2LTEPWR
75	M2BCONFIG2		
MH1	GND	MH2	GND
NH1	NC	NH2	NC

Mini PCIe Connector

Connector location: CN3

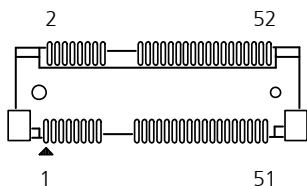

Pin	Definition	Pin	Definition
1	I_WAKEL	2	3VSB_MINILTE
3	NC	4	GND
5	NC	6	1V5_MINI
7	I_PCIECLKREQLO	8	UIM_PWR
9	GND	10	UIM_DATA
11	I_PCIECLKOUTNO	12	UIM_CLK
13	I_PCIECLKOUTPO	14	UIM_RESET
15	GND	16	UIM_VPP
17	NC	18	GND
19	NC	20	LTEDISL
21	GND	22	LTERSTL
23	PCIESATARP	24	3VSB_MINILTE
25	PCIESATARN	26	GND
27	GND	28	1V5_MINI
29	GND	30	I_SMB3P3CLK

Pin	Definition	Pin	Definition
31	PCIESATATN	32	I_SMB3P3DATA
33	PCIESATATP	34	GND
35	GND	36	I_USB2N1
37	GND	38	I_USB2P1
39	3VSB_MINILTE	40	GND
41	3VSB_MINILTE	42	NC
43	GND	44	NC
45	NC	46	NC
47	NC	48	1V5_MINI
49	NC	50	GND
51	NC	52	3VSB_MINILTE
MH1	GND	MH2	GND
MH3	NC	NH4	NC
MH5	NC	MH6	GND
NH1	NC	NH2	NC

COM Port Header

Connector location: COM1

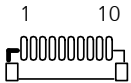

Pin	Definition
1	COM4DCDL
2	COM4RXD
3	COM4TXD
4	COM4DTRL
5	GND
6	COM4DSRL
7	COM4RTSL
8	COM4CTSL
9	COM4RIL
10	GND
MH1	GND
MH2	GND

UART4/I2C Header

Connector location: COM2

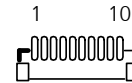

Pin	Definition
1	VCC5
2	NC
3	NC
4	NC
5	GND
6	UART3_TXD
7	UART3_RXD
8	GND
9	I2C_SCL
10	I2C_SDA
MH1	GND
MH2	GND

DE1 Connector

Connector location: DE1

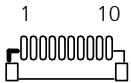

Pin	Definition
1	GND
2	I_PLTRSTL
3	I_ESPICK
4	I_ESPICSOL
5	I_ESPIIO3
6	I_ESPIIO2
7	I_ESPIIO1
8	I_ESPIIO0
9	I_ESPIRSTL
10	3VSB
MH1	GND
MH2	GND

DDR4 SO-DIMM Slot

Connector location: DIMM1

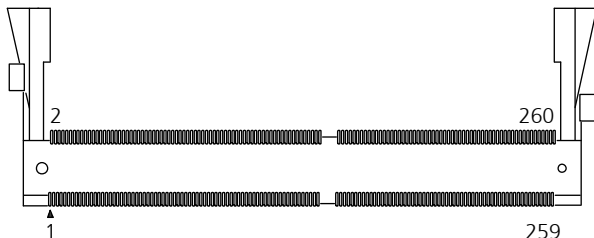

Pin	Definition	Pin	Definition
1	GND	2	GND
3	DDR1_DQ6	4	DDR1_DQ1
5	GND	6	GND
7	DDR1_DQ7	8	DDR1_DQ4
9	GND	10	GND
11	DDR1_DQSN0	12	CHBDM
13	DDR1_DQSP0	14	GND
15	GND	16	DDR1_DQ0
17	DDR1_DQ5	18	GND
19	GND	20	DDR1_DQ2
21	DDR1_DQ3	22	GND
23	GND	24	DDR1_DQ14
25	DDR1_DQ10	26	GND
27	GND	28	DDR1_DQ13
29	DDR1_DQ9	30	GND

Pin	Definition	Pin	Definition
31	GND	32	DDR1_DQSN1
33	CHBDM	34	DDR1_DQSP1
35	GND	36	GND
37	DDR1_DQ12	38	DDR1_DQ11
39	GND	40	GND
41	DDR1_DQ8	42	DDR1_DQ15
43	GND	44	GND
45	DDR1_DQ18	46	DDR1_DQ17
47	GND	48	GND
49	DDR1_DQ16	50	DDR1_DQ20
51	GND	52	GND
53	DDR1_DQSN2	54	CHBDM
55	DDR1_DQSP2	56	GND
57	GND	58	DDR1_DQ19
59	DDR1_DQ22	60	GND

Pin	Definition	Pin	Definition
61	GND	62	DDR1_DQ21
63	DDR1_DQ23	64	GND
65	GND	66	DDR1_DQ29
67	DDR1_DQ26	68	GND
69	GND	70	DDR1_DQ30
71	DDR1_DQ25	72	GND
73	GND	74	DDR1_DQSN3
75	CHBDM	76	DDR1_DQS3
77	GND	78	GND
79	DDR1_DQ28	80	DDR1_DQ27
81	GND	82	GND
83	DDR1_DQ24	84	DDR1_DQ31
85	GND	86	GND
87	DDR1_CB5	88	DDR1_CB4
89	GND	90	GND
91	DDR1_CB1	92	DDR1_CB0
93	GND	94	GND
95	DDR1_DQSN8	96	CHBDM8
97	DDR1_DQSP8	98	GND
99	GND	100	DDR1_CB6
101	DDR1_CB2	102	GND
103	GND	104	DDR1_CB7
105	DDR1_CB3	106	GND
107	GND	108	DDR_RSTL
109	DDR1_CKE0	110	DDR1_CKE1

Pin	Definition	Pin	Definition
111	VDDQ	112	VDDQ
113	DDR1_BG1	114	DDR1_ACTL
115	DDR1_BG0	116	DDR1_ALERTL
117	VDDQ	118	VDDQ
119	DDR1_A12	120	DDR1_A11
121	DDR1_A9	122	DDR1_A7
123	VDDQ	124	VDDQ
125	DDR1_A8	126	DDR1_A5
127	DDR1_A6	128	DDR1_A4
129	VDDQ	130	VDDQ
131	DDR1_A3	132	DDR1_A2
133	DDR1_A1	134	DDR1_EVENTL
135	VDDQ	136	VDDQ
137	DDR1_CLKP0	138	DDR1_CLKP1
139	DDR1_CLKN0	140	DDR1_CLKN1
141	VDDQ	142	VDDQ
143	DDR1_PAR	144	DDR1_A0
145	DDR1_BA1	146	DDR1_A10
147	VDDQ	148	VDDQ
149	DDR1_CSL0	150	DDR1_BA0
151	DDR1_WEL	152	DDR1_RASL
153	VDDQ	154	VDDQ
155	DDR1_ODT0	156	DDR1_CASL
157	DDR1_CSL1	158	DDR1_A13
159	VDDQ	160	VDDQ

Pin	Definition	Pin	Definition
161	DDR1_ODT1	162	DDR1S2L
163	VDDQ	164	DDR1_VREFCA
165	DDR1S3L	166	AD1SA2
167	GND	168	GND
169	DDR1_DQ34	170	DDR1_DQ33
171	GND	172	GND
173	DDR1_DQ32	174	DDR1_DQ36
175	GND	176	GND
177	DDR1_DQSN4	178	CHBDM
179	DDR1_DQSP4	180	GND
181	GND	182	DDR1_DQ35
183	DDR1_DQ38	184	GND
185	GND	186	DDR1_DQ37
187	DDR1_DQ39	188	GND
189	GND	190	DDR1_DQ41
191	DDR1_DQ47	192	GND
193	GND	194	DDR1_DQ42
195	DDR1_DQ43	196	GND
197	GND	198	DDR1_DQSN5
199	CHBDM	200	DDR1_DQSP5
201	GND	202	GND
203	DDR1_DQ45	204	DDR1_DQ44
205	GND	206	GND
207	DDR1_DQ46	208	DDR1_DQ40
209	GND	210	GND
211	DDR1_DQ49	212	DDR1_DQ53

Pin	Definition	Pin	Definition
213	GND	214	GND
215	DDR1_DQ52	216	DDR1_DQ51
217	GND	218	GND
219	DDR1_DQSN6	220	CHBDM
221	DDR1_DQSP6	222	GND
223	GND	224	DDR1_DQ55
225	DDR1_DQ50	226	GND
227	GND	228	DDR1_DQ54
229	DDR1_DQ48	230	GND
231	GND	232	DDR1_DQ57
233	DDR1_DQ61	234	GND
235	GND	236	DDR1_DQ58
237	DDR1_DQ62	238	GND
239	GND	240	DDR1_DQSN7
241	CHBDM	242	DDR1_DQSP7
243	GND	244	GND
245	DDR1_DQ59	246	DDR1_DQ56
247	GND	248	GND
249	DDR1_DQ63	250	DDR1_DQ60
251	GND	252	GND
253	MEMSCL	254	MEMSDA
255	VCC3	256	AD1SA0
257	VPP	258	VDDQ_VTT
259	VPP	260	AD1SA1
MH1		MH2	NC
NH1		NH2	NC

GPIO Header

Connector location: GPIO1

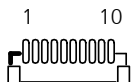

Pin	Definition	Pin	Definition
1	GPIO_PWR	2	GND
3	GPO0_OUT	4	GPIO_IN
5	GPO1_OUT	6	GPI1_IN
7	GPO2_OUT	8	GPI2_IN
9	GPO3_OUT	10	GPI3_IN

Flash BIOS Pin Header

Connector location: JFW1



Pin	Definition	Pin	Definition
1	VSPI	2	GND
3	BIOSSPICSLO	4	BIOSSPICK
5	BIOSSPISO	6	BIOSSPISI

Reset Pin Header

Connector location: JP1



Pin	Description
1	SYSRESETN
2	GND

Nano SIM Connector

Connector location: SIM1

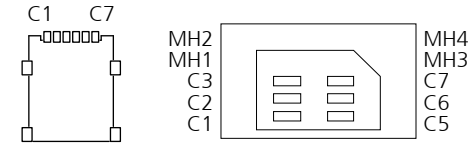

Pin	Definition
C1	UIM_PWR
C2	UIM_RESET
C3	UIM_SIM_CLK
C5	GND
C6	UIM_VPP
C7	UIM_DATA
MH1	GND
MH2	GND
MH3	GND
MH4	GND

CHAPTER 3: SYSTEM SETUP

Removing the Chassis Cover



Prior to removing the chassis cover, make sure the unit's power is off and disconnected from the power sources to prevent electric shock or system damage.

1. Remove the six mounting screws around the chassis cover. There are two screws each on the top and on the sides.
2. With the screws removed, lift up the cover and remove it from the chassis.



Installing a SO-DIMM Memory Module

1. Locate the SO-DIMM socket.

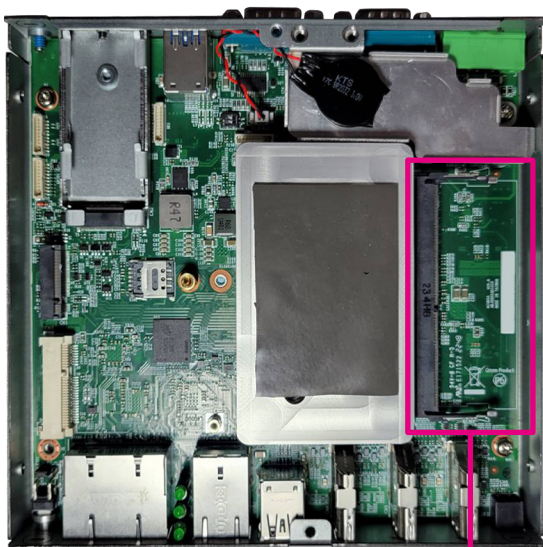

SO-DIMM Socket

2. Insert the module into the socket at an approximately 30-degree angle. Push the module down until the clips on both sides of the socket lock into position. The ejector tabs at the ends of the socket will automatically snap into the locked position to hold the module in place.

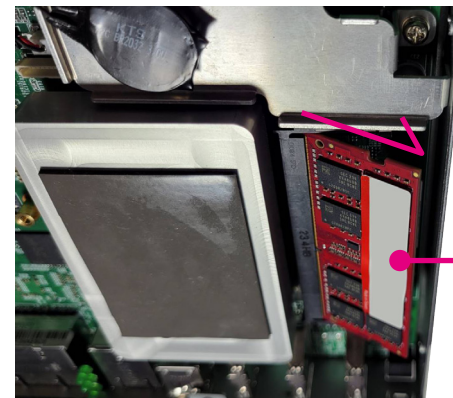

Memory Module

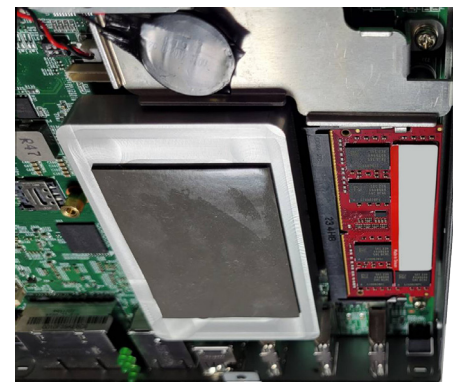



When installing a memory module, it is recommended that to use an industrial grade memory module with wide operating temperature and a dedicated thermal pad is placed on top of the chipset of the memory module for better heat dissipation.

- Optional Thermal Pad E-LIN 60x20x10mm (P/N: 5060200678X00)



Thermal Pad

Installing a mini PCIe Card (Full-Size)

1. Locate the mini-PCIe slot on the board.
2. Insert the module into the mini-PCIe slot at a 45-degree angle until the gold-plated connector on the edge of the module completely disappears into the slot.

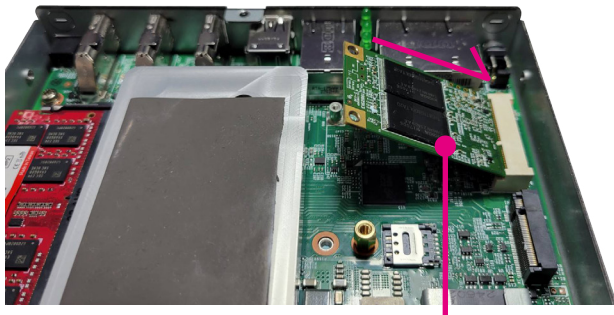

Mini-PCIe Card

3. Push the module down and secure it with a screw.





When installing a mini-PCIe module, it is recommended that to use an industrial grade module with wide operating temperature and a dedicated thermal pad is placed on top of the chipset of the module for better heat dissipation.

- Optional Thermal Pad E-LIN 30x20x12mm (P/N: 5060200675X00)



Thermal Pad

Installing an M.2 Key B Module

This device has two M.2 Key B slots, one accessible from the front panel and one internal. The front accessible slot supports 2242 modules, and the internal slot supports 2242/3042/3052 modules. Follow the steps below to install the M.2 module.

Front accessible M.2 Key B

1. Unscrew the M.2 bay tray on the front panel and remove it from the device.

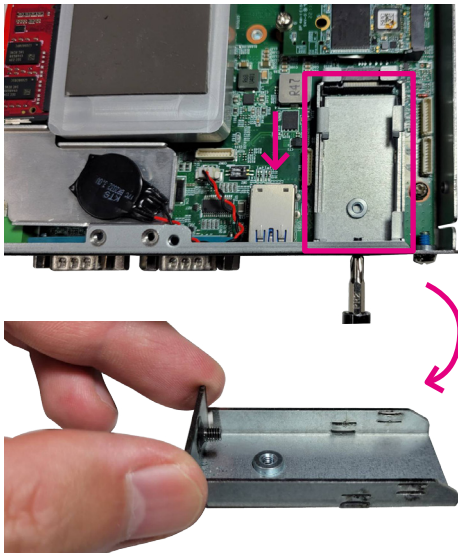

2. Align the notch on the M.2 module with the screw hole on the bay tray.

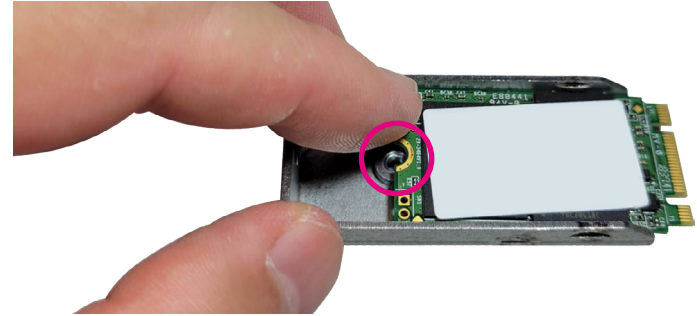

3. Secure the M.2 module to the bay tray with a screw.

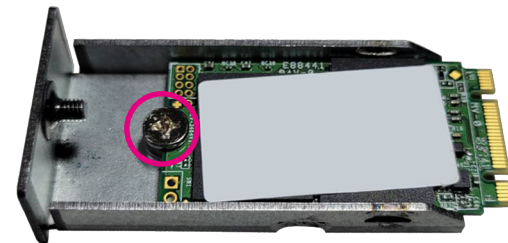

4. Reinstall the bay tray in the device and secure it with the screw you removed in [step 1](#).

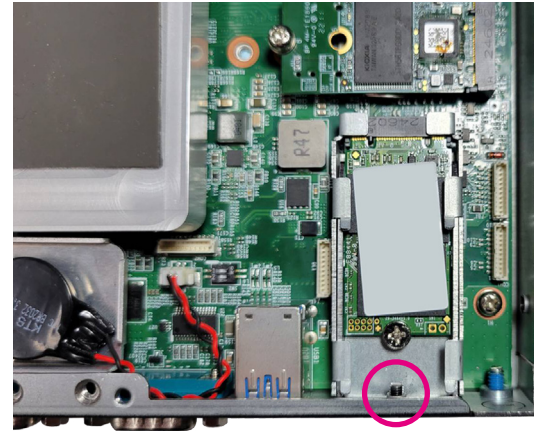
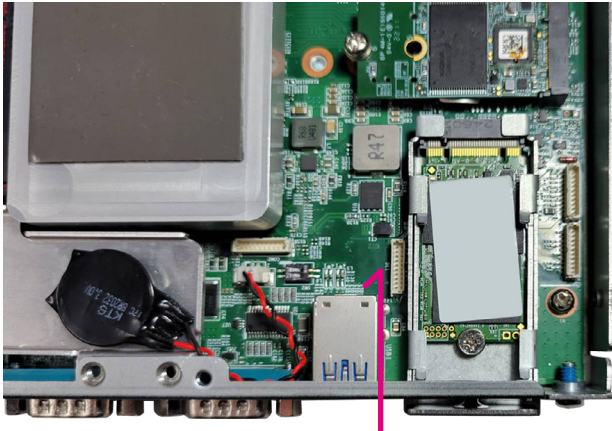

Internal M.2 Key B

1. Secure the M.2 standoff into the appropriate mounting hole on the motherboard, matching it with the M.2 length, using a screwdriver.

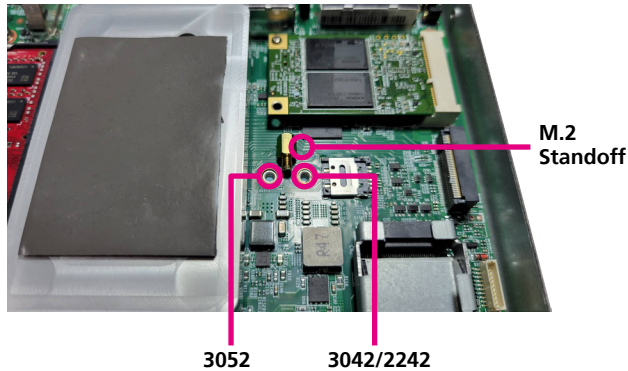

2. Insert the module into the M.2 slot at a 45 degrees angle until the gold-plated connector on the edge of the module completely disappears inside the slot.



3. Fasten a screw into the M.2 standoff mounting hole to secure the module in place.

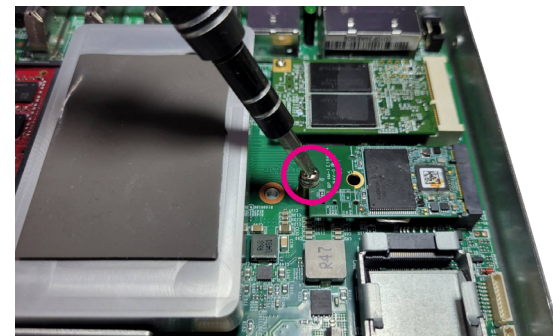
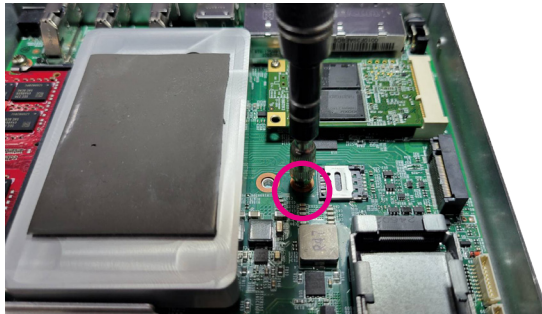

Installing a SIM Card

1. Locate the SIM card holder on the motherboard.
2. Flip up the SIM Card Slot cover and place the SIM card onto the holder.

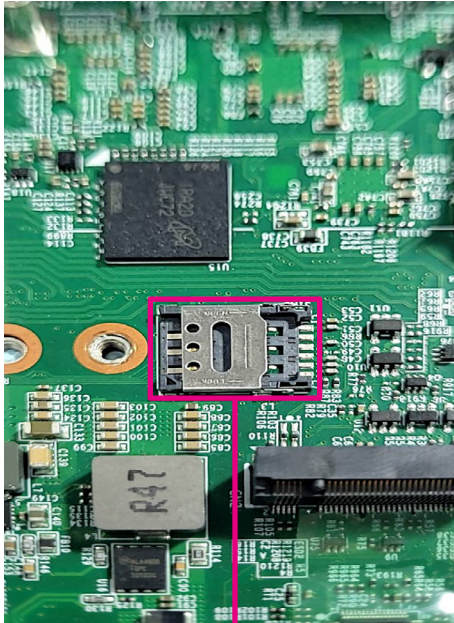

SIM Card Cover

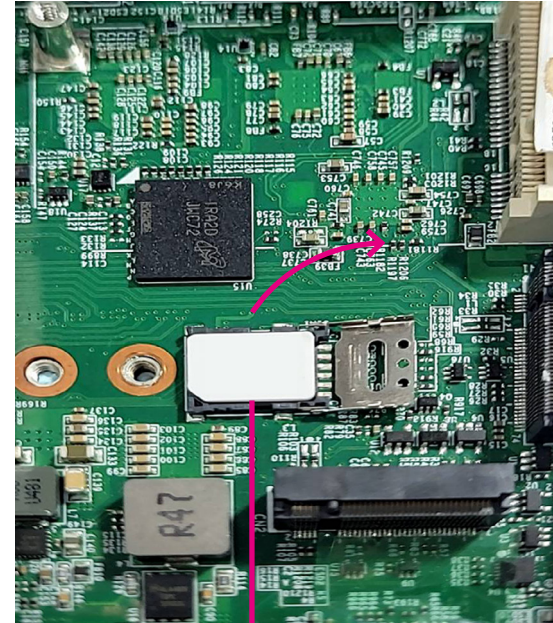

SIM Card

3. Close the cover and secure it to the original position.

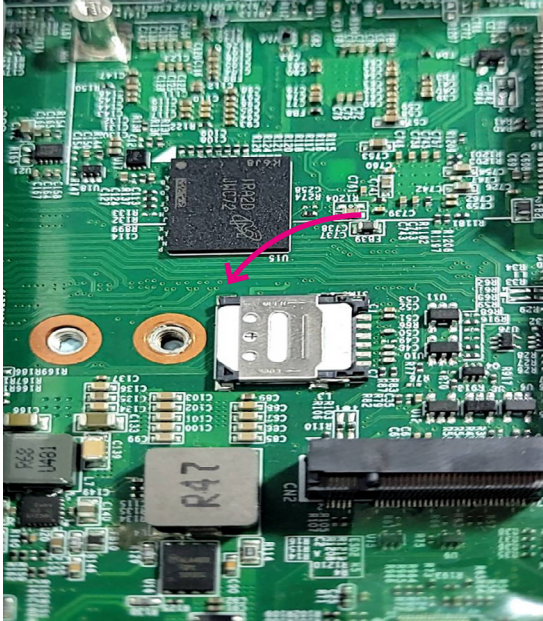

Installing an Antenna



Please remove the gaskets (ring 1 and ring 2) on the SMA antenna jack first.

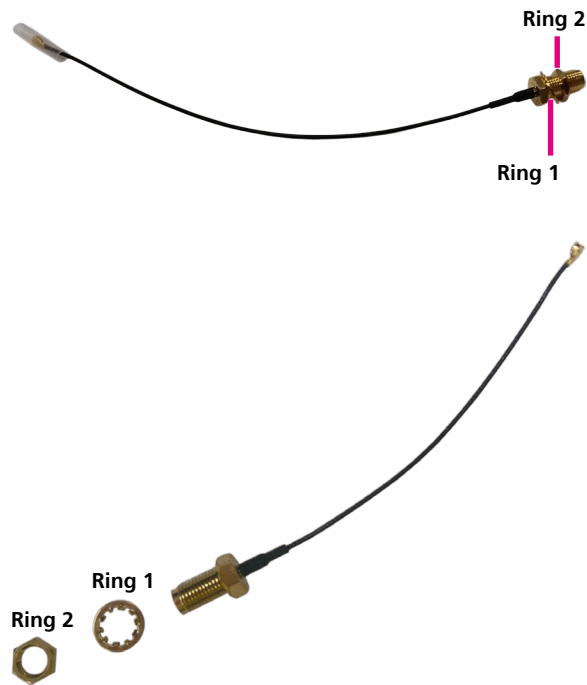

1. Remove the antenna hole cover located on the front and rear panel.



2. Insert the SMA antenna jack end of the cable through the antenna hole, and insert the 2 rings (ring 1 and ring 2) and two washers back to the antenna jack.



Gasket and washer installation sequence.

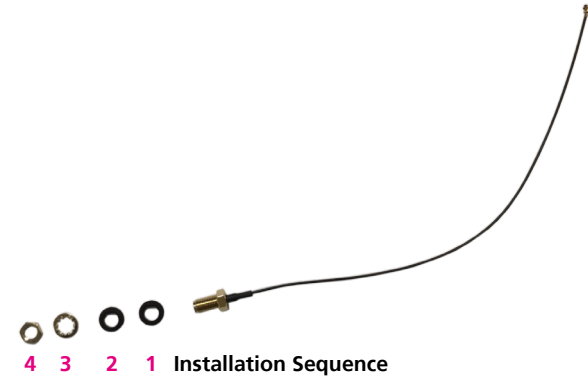
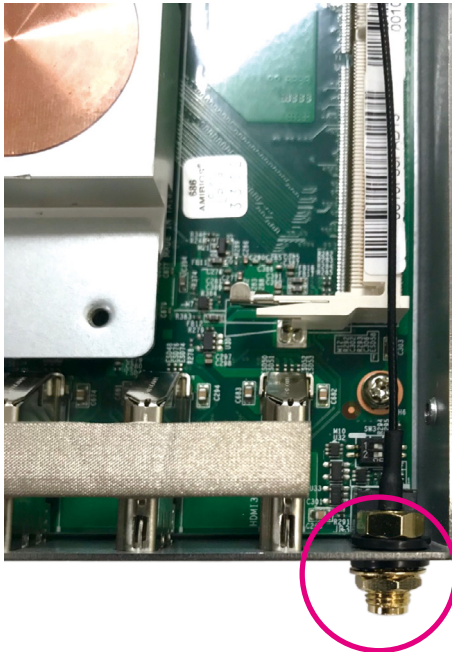



When installing Wi-Fi or 4G LTE antennas, make sure the washers (P/N:5061600245X00) are fitted onto the antenna connector, one on each side as shown below.

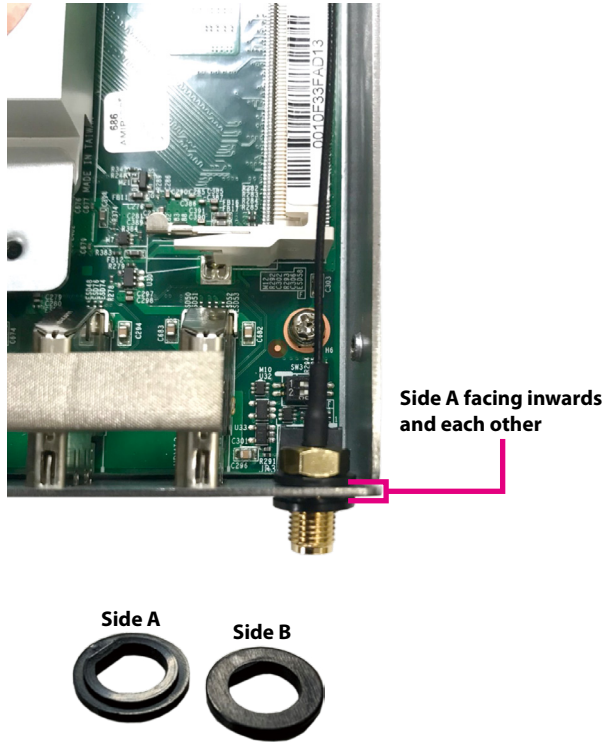

3. Attach the RF cable onto the module.

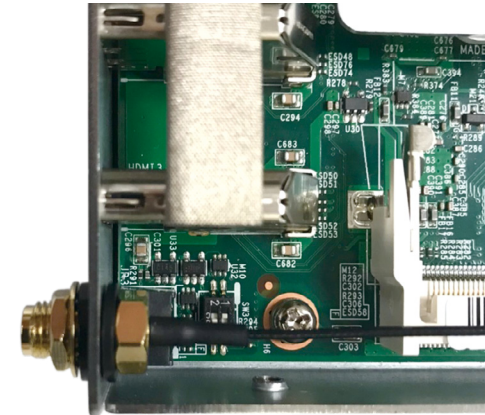
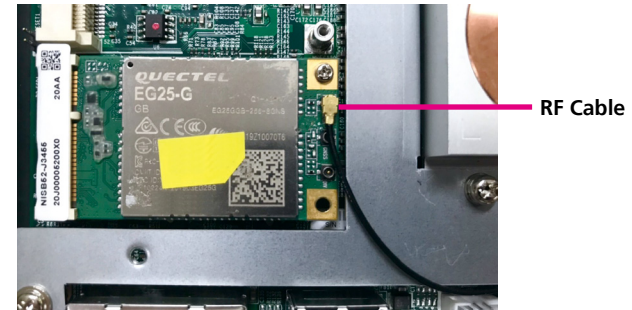

4. Connect the external antenna to the antenna jack.

CHAPTER 4: BIOS SETUP

This chapter describes how to use the BIOS setup program for NISE 53. The BIOS screens provided in this chapter are for reference only and may change if the BIOS is updated in the future.

To check for the latest updates and revisions, visit the NexAIoT website at www.nexaiot.com.

About BIOS Setup

The BIOS (Basic Input and Output System) Setup program is a menu driven utility that enables you to make changes to the system configuration and tailor your system to suit your individual work needs. It is a ROM-based configuration utility that displays the system's configuration status and provides you with a tool to set system parameters.

These parameters are stored in non-volatile battery-backed-up CMOS RAM that saves this information even when the power is turned off. When the system is turned back on, the system is configured with the values found in CMOS.

With easy-to-use pull down menus, you can configure items such as:

- Hard drives, diskette drives, and peripherals
- Video display type and display options
- Password protection from unauthorized use
- Power management features

The settings made in the setup program affect how the computer performs. It is important, therefore, first to try to understand all the setup options, and second, to make settings appropriate for the way you use the computer.

When to Configure the BIOS

- This program should be executed under the following conditions:
 - When changing the system configuration
 - When a configuration error is detected by the system and you are prompted to make changes to the setup program
 - When resetting the system clock
 - When redefining the communication ports to prevent any conflicts
 - When making changes to the Power Management configuration
 - When changing the password or making other changes to the security setup

Normally, CMOS setup is needed when the system hardware is not consistent with the information contained in the CMOS RAM, whenever the CMOS RAM has lost power, or the system features need to be changed.

Default Configuration

Most of the configuration settings are either predefined according to the Load Optimal Defaults settings which are stored in the BIOS or are automatically detected and configured without requiring any actions. There are a few settings that you may need to change depending on your system configuration.











Entering Setup

When the system is powered on, the BIOS will enter the Power-On Self Test (POST) routines. These routines perform various diagnostic checks; if an error is encountered, the error will be reported in one of two different ways:

- If the error occurs before the display device is initialized, a series of beeps will be transmitted.
- If the error occurs after the display device is initialized, the screen will display the error message.

Powering on the computer and immediately pressing  allows you to enter Setup.

Legends

Key	Function
	Moves the highlight left or right to select a menu.
	Moves the highlight up or down between sub-menu or fields.
	Exits the BIOS Setup Utility.
	Scrolls forward through the values or options of the highlighted field.
	Scrolls backward through the values or options of the highlighted field.
	Selects a field.
	Displays General Help.
	Load previous values.
	Load optimized default values.
	Saves and exits the Setup program.
	Press <Enter> to enter the highlighted sub-menu.

Scroll Bar

When a scroll bar appears to the right of the setup screen, it indicates that there are more available fields not shown on the screen. Use the up and down arrow keys to scroll through all the available fields.

Submenu

When “▶” appears on the left of a particular field, it indicates that a submenu which contains additional options are available for that field. To display the submenu, move the highlight to that field and press  .

BIOS Setup Utility

Once you enter the AMI BIOS Setup Utility, the Main Menu will appear on the screen. The main menu allows you to select from several setup functions and one exit. Use arrow keys to select among the items and press  to accept or enter the submenu.

Main

The Main menu is the first screen that you will see when you enter the BIOS Setup Utility.

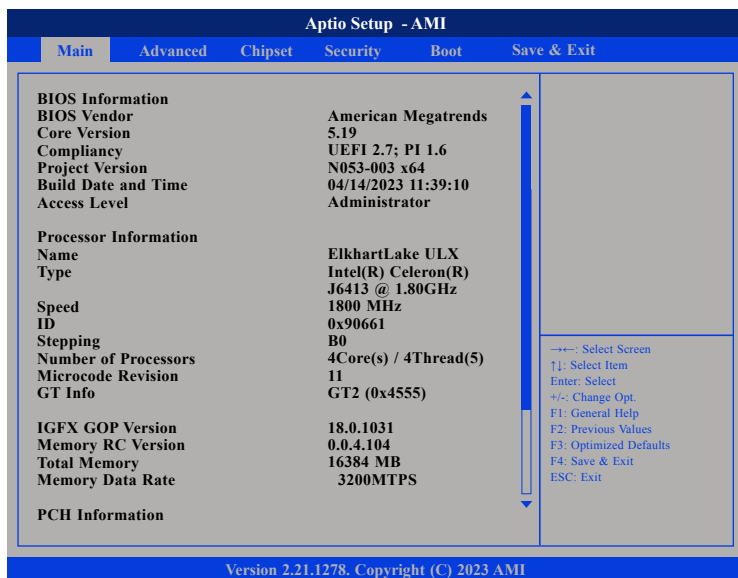

System Date

The date format is <day>, <month>, <date>, <year>. Day displays a day, from Monday to Sunday. Month displays the month, from January to December. Date displays the date, from 1 to 31. Year displays the year, from 2005 to 2099.

System Time

The time format is <hour>, <minute>, <second>. The time is based on the 24-hour military-time clock. For example, 1 p.m. is 13:00:00. Hour displays hours from 00 to 23. Minute displays minutes from 00 to 59. Second displays seconds from 00 to 59.

Advanced

The Advanced menu allows you to configure your system for basic operation. Some entries are defaults required by the system board, while others, if enabled, will improve the performance of your system or let you set some features according to your preference.



Setting incorrect field values may cause the system to malfunction.

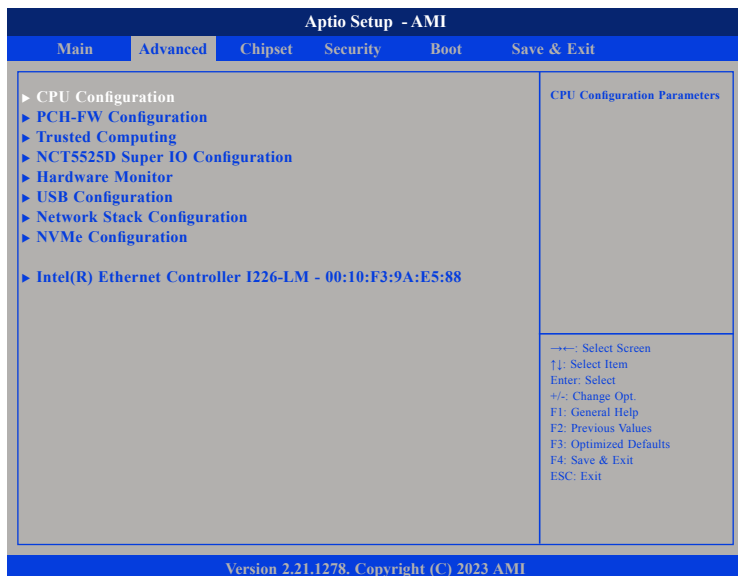

CPU Configuration

This section is used to configure CPU settings.

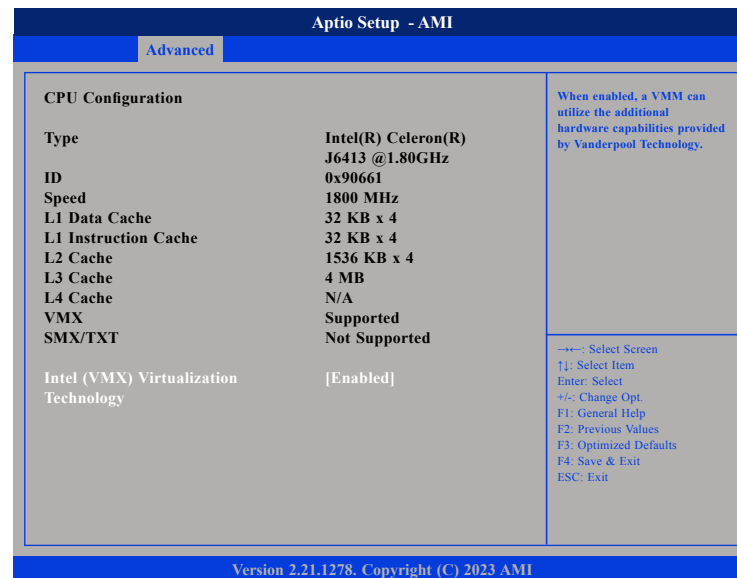

Intel (VMX) Virtualization Technology

When this option is set to Enabled, the VMM can utilize the additional hardware capabilities provided by Vanderpool Technology.

PCH-FW Configuration

This section is used to configure the settings for the PTT.



PTT Configuration

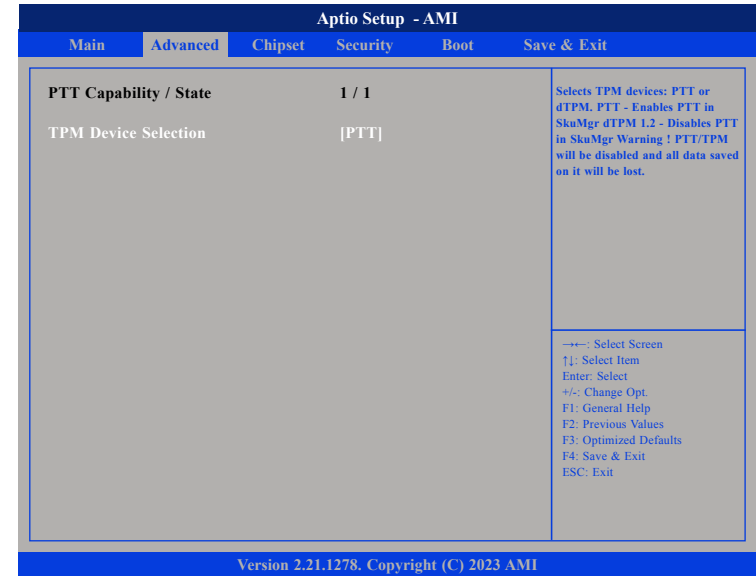

TPM Device Selection

Use to select a TPM device. The options are PTT and dTPM.

Warning! PTT/dTPM will be disabled and all data saved on it will be lost.

Trusted Computing

This section is used to configure CPU settings.

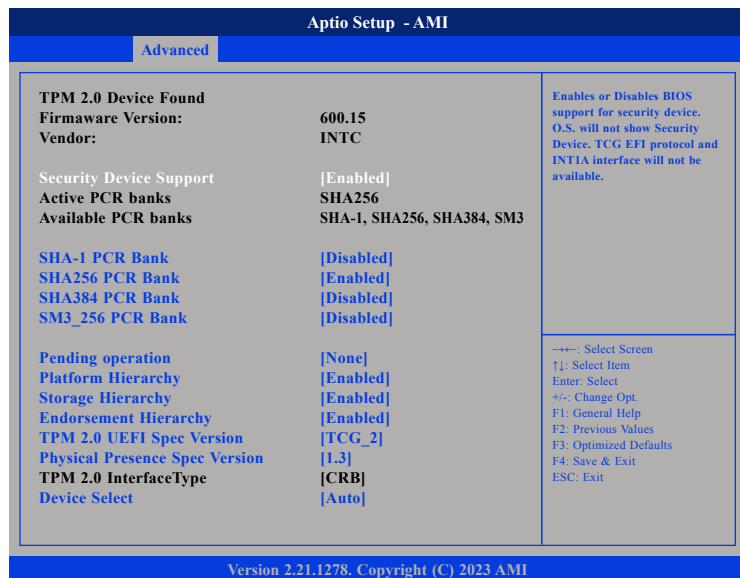

Security Device Support

Enable or disable BIOS support for security device. O.S will not show Security Device. TCG EFI protocol and INT1A interface will not be available.

SHA-1 PCR Bank

Enable or disable SHA-1 PCR Bank.

SHA256 PCR Bank

Enable or disable SHA256 PCR Bank.

SHA384 PCR Bank

Enable or disable SHA384 PCR Bank.

SM3_256 PCR Bank

Enable or disable SM3_256 PCR Bank.

Pending operation

Schedule an operation for the security device.

Platform Hierarchy

Enable or disable platform hierarchy.

Storage Hierarchy

Enable or disable storage hierarchy.

Endorsement Hierarchy

Enable or disable endorsement hierarchy.

TPM 2.0 UEFI Spec Version

Configure the TPM2.0 UEFI spec version.

Physical Presence Spec Version

Configure the physical presence spec version.

Device Select

TPM 1.2 will restrict support to TPM 1.2 devices. TPM 2.0 will restrict support to TPM 2.0 devices. Auto will support both TPM 1.2 and 2.0 devices with the default set to TPM 2.0 devices if not found, and TPM 1.2 devices will be enumerated.

NCT5525D Super IO Configuration

This section is used to configure the serial ports.

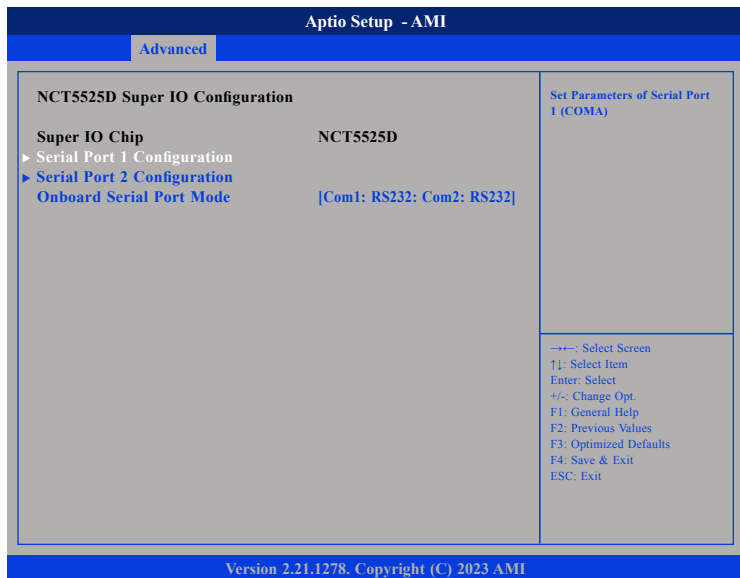

Serial Port 1 Configuration

Configuration settings for serial port 1.

Serial Port 2 Configuration

Configuration settings for serial port 2.

Onboard Serial Port Mode

Change the serial port mode.

Serial Port 1/2 Configuration

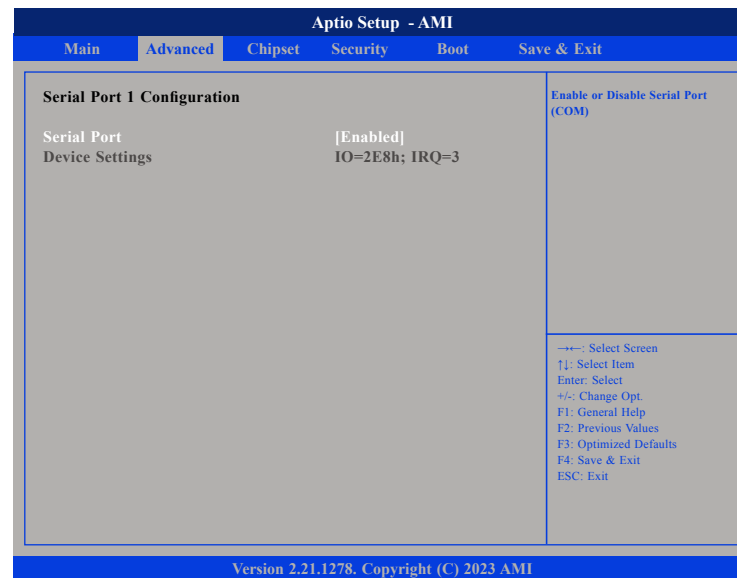

Serial Port

Enable or disable the serial port.

Hardware Monitor

This section is used to monitor hardware status such as temperature or voltages.

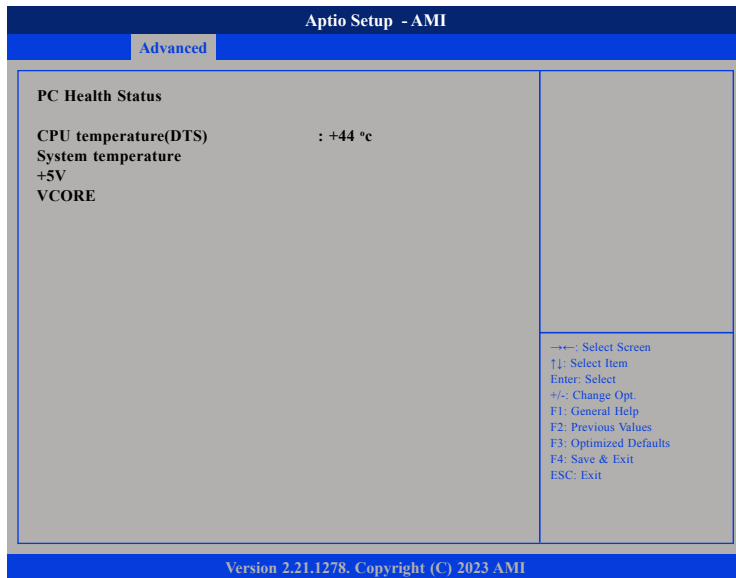

CPU and System Temperature

Detect and display the current CPU and system temperature.

+5V and VCORE

Detect and display the output voltages.

USB Configuration

This section is used to configure the USB.

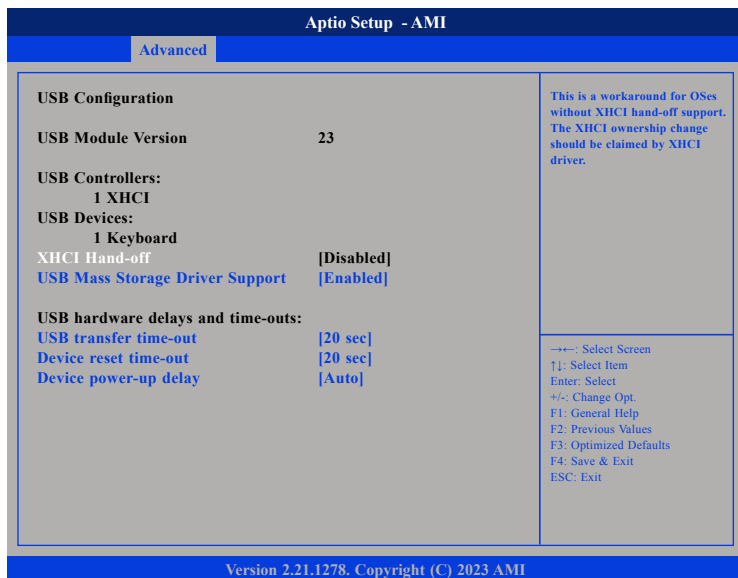

XHCI Hand-off

This is a workaround for OSs that does not support XHCI hand-off. The XHCI ownership change should be claimed by the XHCI driver.

USB Mass Storage Driver Support

Enable or disable USB mass storage driver support.

USB transfer time-out

The time-out value for control, bulk, and interrupt transfers.

Device reset time-out

Select the USB mass storage device's start unit command timeout.

Device power-up delay

Maximum time the device will take before it properly reports itself to the Host Controller. "Auto" uses default value: for a Root port it is 100ms, for a Hub port the delay is taken from Hub descriptor.

Network Stack Configuration

This section is used to configure the network stack.

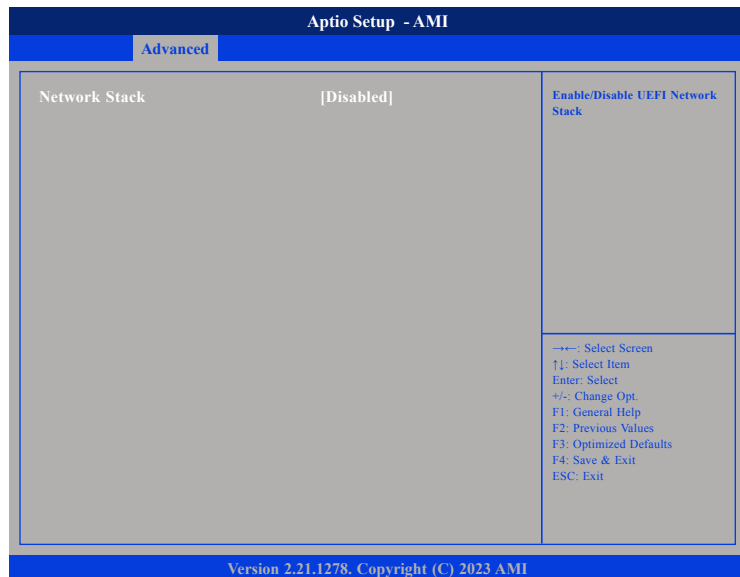

Network Stack

Enable or disable UEFI network stack.

NVMe Configuration

This section is used to display information on the NVMe devices installed.

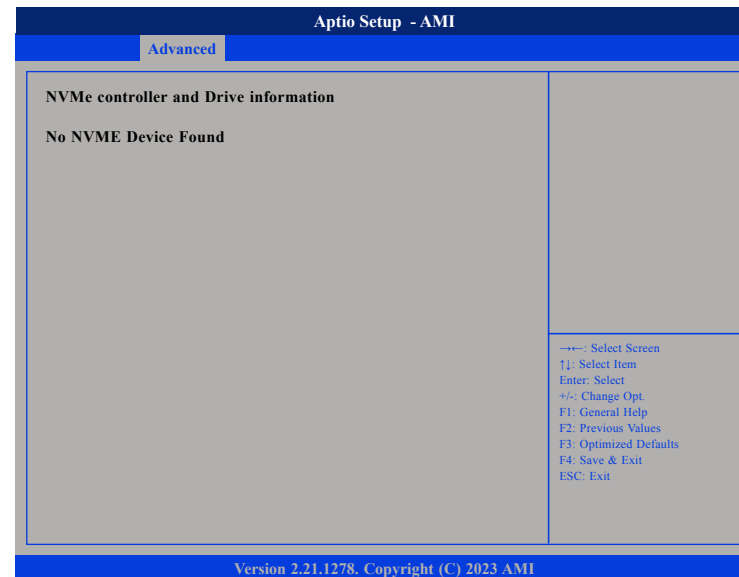

Intel(R) Ethernet Controller I226-LM - 00:10:F3:9A:E5:8B

This section is used to display information of bundled Intel Ethernet controller.

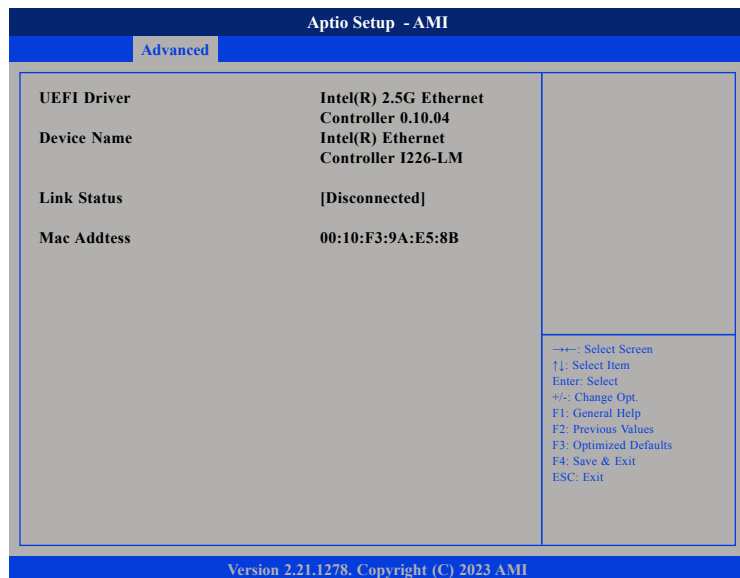

Chipset

This section gives you functions to configure the system based on the specific features of the chipset.

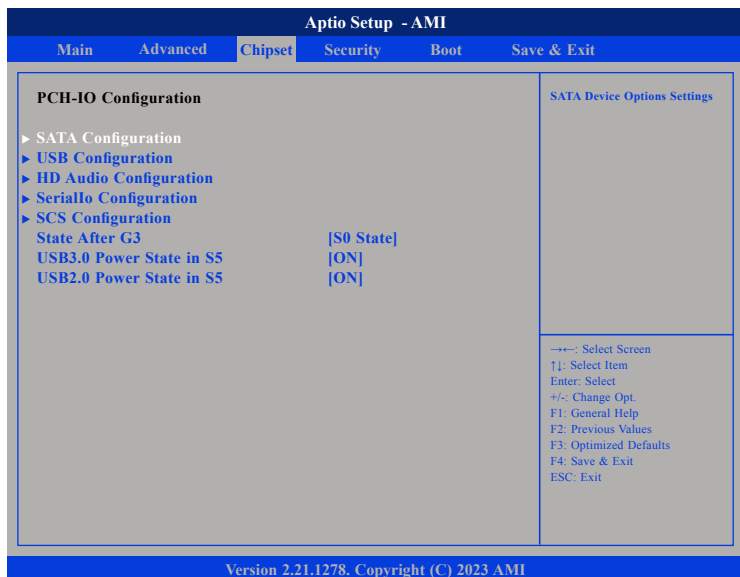

State After G3

Configure the state the system will enter when power is reapplied after a power failure (G3 state)

USB3.0/2.0 Power State in S5

Configure USB3.0/2.0 power state in S5.

SATA Configuration

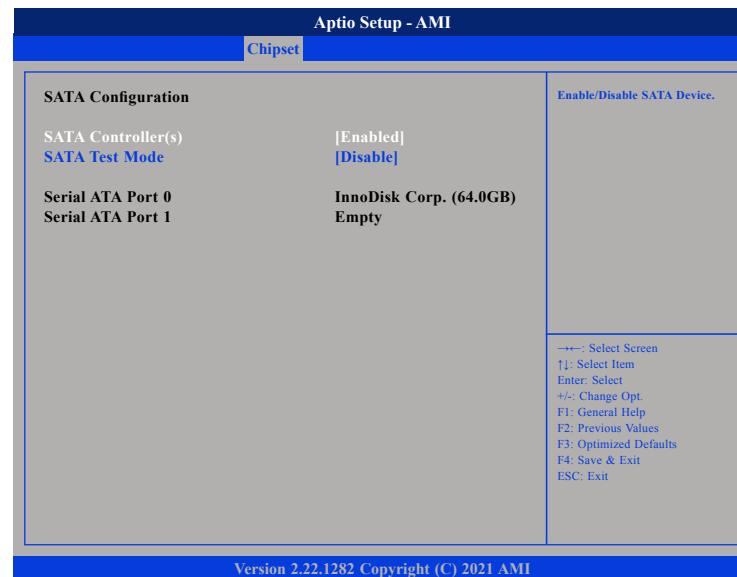

SATA Controller(s)

Enable or disable SATA device.

SATA Test Mode

Enable or disable the SATA test mode.

USB Configuration

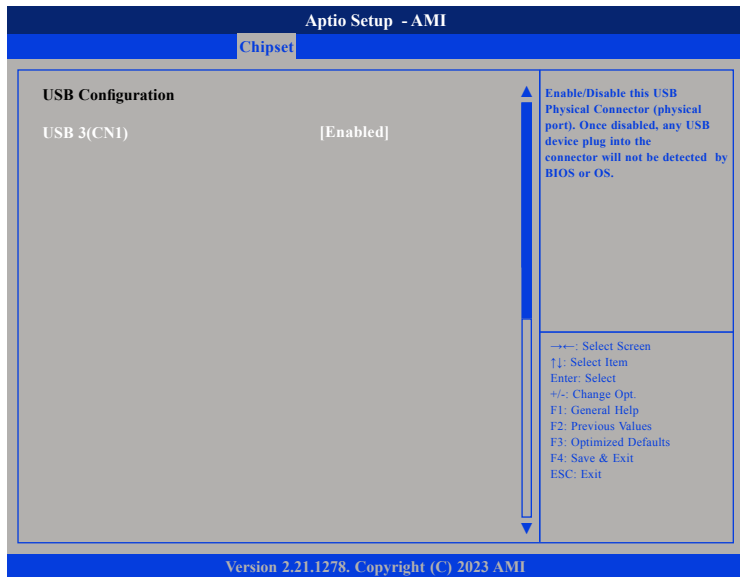

USB3(CN1)

Enable or disable this USB physical connector (physical port). Once disabled, any USB device plug into the connector will not be detected by BIOS or OS.

HD Audio Configuration

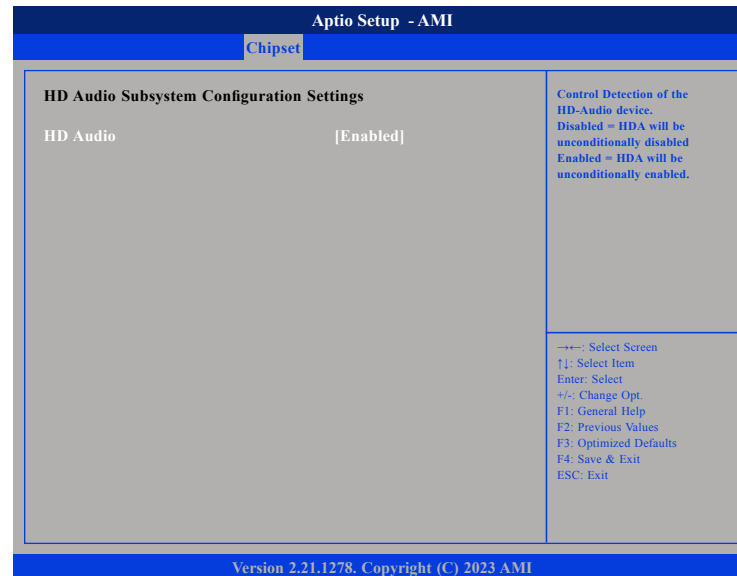

HD Audio

Control detection of the HD audio device.

Disabled: HD audio will be unconditionally disabled.
Enabled: HD audio will be unconditionally enabled.

Serial IO Configuration

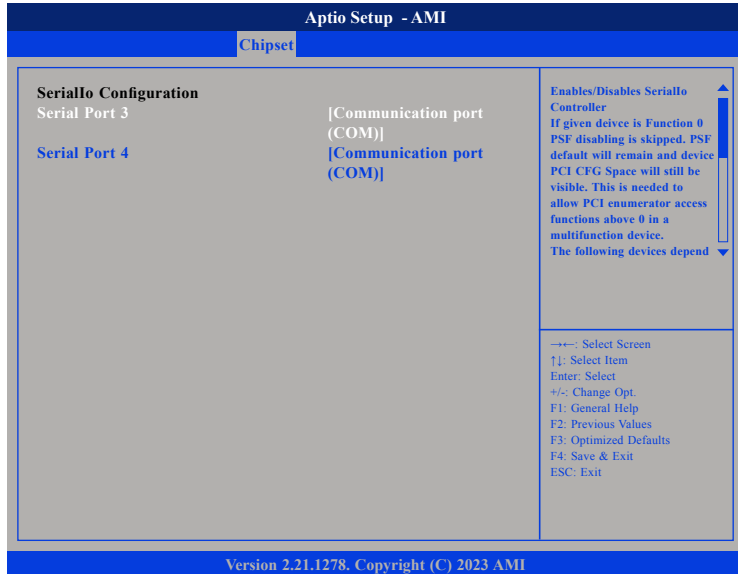

Serial Port 3/4

Enable or disable serial IO controller.

SCS Configuration

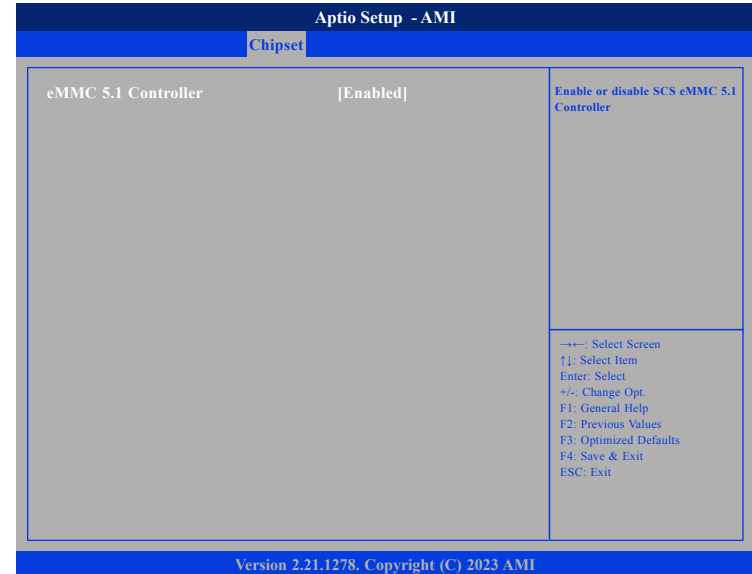

eMMC 5.1 Controller

Enable or disable SCS eMMC 5.1 controller.

Security

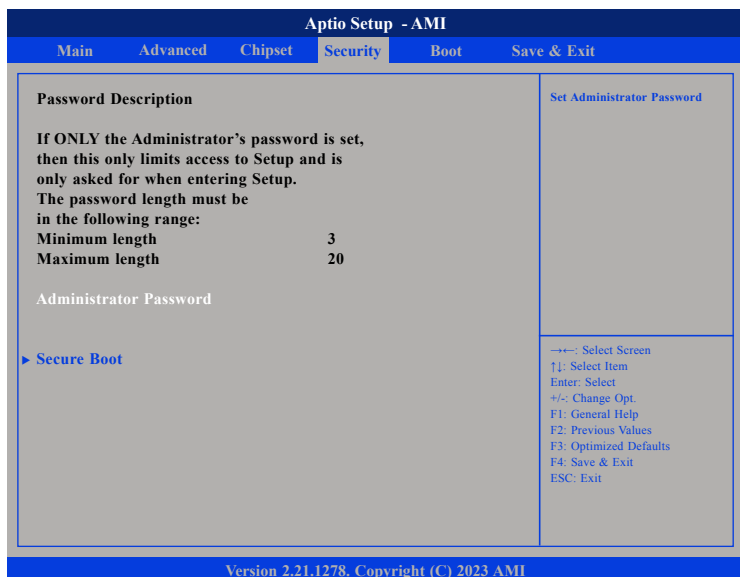

Administrator Password

Select this to reconfigure the administrator's password.

Secure Boot



Secure Boot

Select this to enable or disable Secure Boot. Secure Boot only works when the system runs in user mode.

Secure Boot Mode

Select this to configure the Secure Boot mode.

Standard: Fixed secure boot policy.

Custom: Secure boot policy variables can be configured by a physically present user without full authentication.

Boot

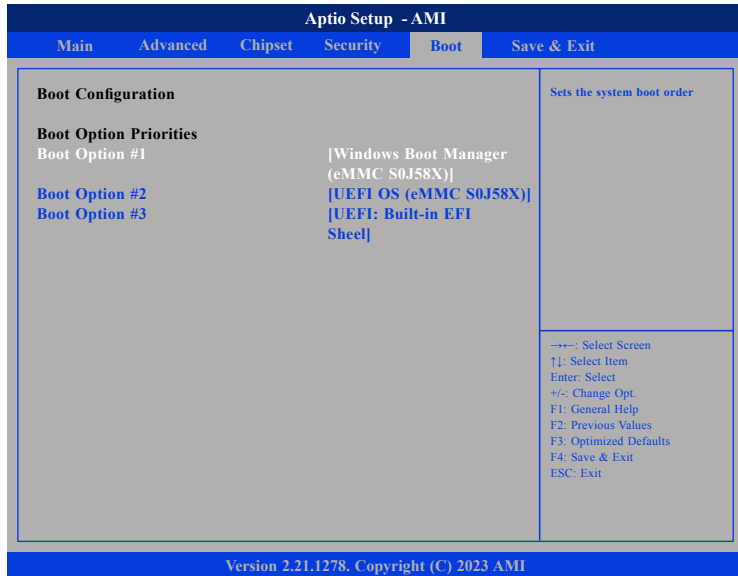

Boot Option #1 to #3

Adjust the boot sequence of the system. Boot Option #1 is the first boot device that the system will boot from, next will be #2 and so forth.

Save & Exit

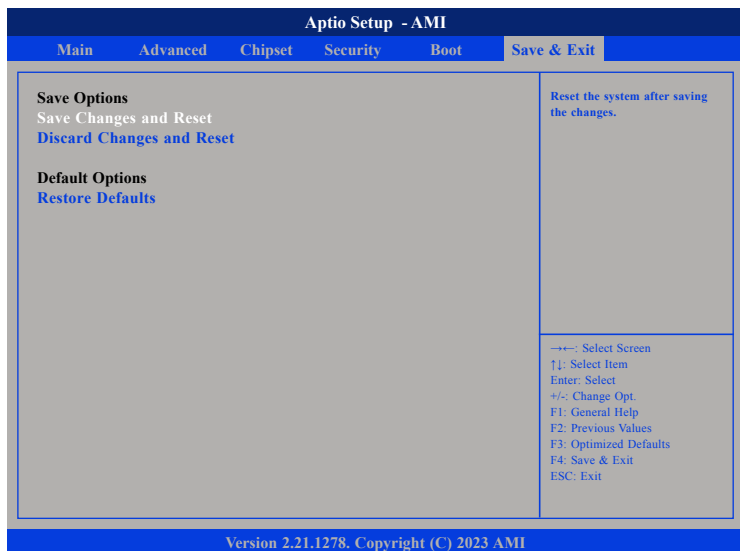

Restore Defaults

To restore the BIOS to default settings, select this field then press <Enter>. A dialog box will appear. Confirm by selecting Yes.

Save Changes and Reset

To save the changes and reset, select this field then press <Enter>. A dialog box will appear. Confirm by selecting Yes. You can also press <F4> to save and exit Setup.

Discard Changes and Reset

To exit the Setup utility and reset without saving the changes, select this field then press <Enter>. You may be prompted to confirm again before exiting. You can also press <ESC> to exit without saving the changes.

APPENDIX A: GPIO PROGRAMMING GUIDE

GPIO (General Purpose Input/Output) pins are provided for custom system design. This appendix provides definitions and its default setting for the ten GPIO pins in the NISE 53 series. The pin definition is shown in the following table:

GPIO Connector

Pin	GPIO Mode	PowerOn Default	Address	Pin	GPIO Mode	PowerOn Default	Address
1	VCC			2	GND		
3	GPO0	Low	0xFD6E09E0 (Bit0)	4	GPI0	High	0xFD6E09A0 (Bit1)
5	GPO1	Low	0xFD6E0A00 (Bit0)	6	GPI1	High	0xFD6E09B0 (Bit1)
7	GPO2	Low	0xFD6E0A50 (Bit0)	8	GPI2	High	0xFD6E09C0 (Bit1)
9	GPO3	Low	0xFD6E0A60 (Bit0)	10	GPI3	High	0xFD6E09D0 (Bit1)

GPO LED

Pin	GPIO Mode	PowerOn Default	Address
LED2	GPO	High	A02h (Bit3)
LED3	GPO	High	A02h (Bit4)

The bit is Set/Clear indicated output High/Low.

APPENDIX B: WATCHDOG TIMER SETTING

NCT5525D Watchdog Programming Guide

```
#define SUPERIO_PORT0    x2E
#define WDT_SET         0xF0
#define WDT_VALUE       0xF1

void main(void)
{
    #Enter SuperIO Configuration
        outputb(SUPERIO_PORT, 0x87);
        outputb(SUPERIO_PORT, 0x87);

    # Set LDN
        outputb(SUPERIO_PORT, 0x07);
        outputb(SUPERIO_PORT+1 ,0x08);

    # Set WDT setting
        outputb(SUPERIO_PORT, WDT_SET);
        outputb(SUPERIO_PORT+1, 0x00); # Use the second
                                         # Use the minute, change value to 0x08

    # Set WDT sec/min
        outputb(SUPERIO_PORT, WDT_VALUE);
        outputb(SUPERIO_PORT+1, 0x05); #Set 5 seconds
}
```

APPENDIX C: POWER CONSUMPTION

Power Consumption Management

This is the maximum power consumption of NISE53. For normal usage, please refer to the system test table below.

CRB	Net Name															
Voltage Chipset	Voltage	5V	5V	3.3V	3.3V	1.2V	1.8V	1.8V	2.5V	0.6V	1.2V	1.05V	1.8V	0~2V	Subtotal power	
	Net Name	5VSB	VCC5	3VSB	VCC3		1V8	1V8SB	VPP	VDDQ_VTT	VDDQ	VCCIO	VCCINAUX	VCCIN		
Elkhart Lake lake (10w)				0.4			0.2	1			3.5	6.5	15	28		
DDR4 on Board									1	0.5	3					
DDR4 SO-DIMM									1	0.5	3					
88E1512-A0-NNP2C00				0.5												
I226V				0.5												
SIO NCT5525				0.08	0.3											
ALC886			0.1		0.1											
M.2x2				6												
USB3.1 x3		2.7														
USB2 x1		0.5														
HDMI x3			1.5													
TPM				0.03												
UFS				0.5												
EMMC				0.5												
GPIO			0.5													
System Total Current (A)		3.2	2.1	8.51	0.4	0	0.2	1	2	1	9.5	6.5	15	28		
System Total Watter (W)		16	10.5	28.083	1.32	0	0.36	1.8	5	0.6	11.4	6.175	12		93.238	