

NuDAQ[®]
6208 Series
Multi-channel
Analog Output Cards
User's Guide



Recycled Paper

©Copyright 1999~2000 ADLINK Technology Inc.

All Rights Reserved.

Manual Rev. 3.20: October 7, 2000

The information in this document is subject to change without prior notice in order to improve reliability, design and function and does not represent a commitment on the part of the manufacturer.

In no event will the manufacturer be liable for direct, indirect, special, incidental, or consequential damages arising out of the use or inability to use the product or documentation, even if advised of the possibility of such damages.

This document contains proprietary information protected by copyright. All rights are reserved. No part of this manual may be reproduced by any mechanical, electronic, or other means in any form without prior written permission of the manufacturer.

Trademarks

NuDAQ®, NuIPC®, DAQBench are registered trademarks of ADLINK Technology Inc.

Other product names mentioned herein are used for identification purposes only and may be trademarks and/or registered trademarks of their respective companies.

Getting service from ADLINK

Customer Satisfaction is always the most important thing for ADLINK Tech Inc. If you need any help or service, please contact us and get it.

ADLINK Technology Inc.			
Web Site	http://www.adlink.com.tw http://www.adlinktechnology.com		
Sales & Service	service@adlink.com.tw		
Technical Support	NuDAQ	nudaq@adlink.com.tw	
	NuDAM	nudam@adlink.com.tw	
	NuIPC	nuipc@adlink.com.tw	
	NuPRO	nupro@adlink.com.tw	
	Software	sw@adlink.com.tw	
TEL	+886-2-82265877	FAX	+886-2-82265717
Address	9F, No. 166, Jian Yi Road, Chungho City, Taipei, 235 Taiwan,		

Please inform us of your detailed information for a prompt, satisfactory and constant service.

Detailed Company Information			
Company/Organization			
Contact Person			
E-mail Address			
Address			
Country			
TEL		FAX	
Web Sit			

Questions	
Product Model	
Environment to Use	<input type="checkbox"/> OS _____ <input type="checkbox"/> Computer Brand _____ <input type="checkbox"/> M/B: _____ <input type="checkbox"/> CPU: _____ <input type="checkbox"/> Chipset: _____ <input type="checkbox"/> BIOS: _____ <input type="checkbox"/> Video Card: _____ <input type="checkbox"/> Network Interface Card: _____ <input type="checkbox"/> Other: _____
Challenge Description	
Suggestions for ADLINK	

Table of Contents

Chapter 1 Introduction	1
1.1 Features.....	2
1.2 Applications	2
1.3 Specifications	2
1.4 Software Supporting	4
1.4.1 <i>Programming Library</i>	4
1.4.2 <i>PCIS-LVIEW: LabVIEW[®] Driver</i>	5
1.4.3 <i>PCIS-VEE: HP-VEE Driver</i>	5
1.4.4 <i>DAQBench[™]: ActiveX Controls</i>	6
1.4.5 <i>DASYLab[™] PRO</i>	6
1.4.6 <i>PCIS-DDE: DDE Server and InTouch[™]</i>	6
1.4.7 <i>PCIS-ISG: ISaGRAF[™] driver</i>	6
1.4.8 <i>PCIS-ICL: InControl[™] Driver</i>	6
1.4.9 <i>PCIS-OPC: OPC Server</i>	6
Chapter 2 Installation	7
2.1 What You Have	7
2.2 Unpacking	8
2.3 PCB Layout.....	9
2.4 Connector Pin Assignment	11
2.5 Hardware Installation Outline	12
2.6 Device Installation for Windows Systems	13
2.7 Termination Board Connection	13
Chapter 3 Registers Format	14
3.1 PCI PnP Registers	14
3.2 I/O Address Map.....	15
3.3 Analog Output Status Register	15
3.4 Digital Output Register.....	16
3.5 Digital Input Register	16
Chapter 4 Operation Theorem	17
4.1 Voltage Output.....	17
4.2 Current Output and Range Control.....	18
Chapter 5 C\C++ Library	19
5.1 Libraries Installation	19
5.2 Programming Guide	20
5.2.1 <i>Naming Convention</i>	20
5.2.2 <i>Data Types</i>	20

5.3	_6208_Initial.....	21
5.4	_6208_Software_Reset.....	22
5.5	_6208_DA	23
5.6	_6208_Get_DA_Status	24
5.7	_6208_DI.....	25
5.8	_6208_DO.....	26
5.9	_6208_I2V_Control.....	27
Chapter 6 Utility / Calibration		28
6.1	Running the 6208util.exe	28
6.1.1	<i>Functional Testing</i>	29
6.1.2	<i>Calibration</i>	30
6.2	Calibration of Analog Output Channel.....	32
6.2.1	<i>What You Need</i>	32
6.2.2	<i>VR Assignemnt of cPCI/PCI-6208 and PCI-6216</i>	32
6.2.3	<i>Voltage Output Calibration</i>	33
6.2.4	<i>Current Output Calibration</i>	33
Product Warranty/Service		34

How to Use This Guide

This manual is designed to help you use the 6208 series products. It describes how to modify and control various functions on these products to meet your requirements. It is divided into six chapters:

- **Chapter 1**, "Introduction", gives an overview of the product features, applications, and specifications.
- **Chapter 2** "Installation", describes how to install the 6208 series products. The layout of 6208 series products are shown, the connectors specifications, and the notes for installation are described.
- **Chapter 3**, "Registers Format", describes the details of register format and structure of the 6208 series products, this information is very important for the programmers who want to control the hardware by low-level programming.
- **Chapter 4**, "Operation Theorem", describes more detail concept about 6208's functions, including analog output and range control systems.
- **Chapter 5** "Software Library", describes the software libraries for programming the 6208 series cards. The software libraries for DOS and Windows 95 are provided. It helps users to control 6208 series cards in high-level programming languages.
- **Chapter 6**, "Utility/Calibration", describes how to run the utility program included in the software CD. And how to calibrate the 6208 series cards for accurate operation.



Introduction

The 6208 series products are multi-channel analog output cards. They include the following three products:

- cPCI/PCI-6208V: 8-CH voltage output card for cPCI/PCI interface
- cPCI/PCI-6208A: 8-CH voltage and current output card for cPCI/PCI interface
- PCI-6216V: 16-CH voltage output card for PCI interface

cPCI-6208V, PCI-6208V:

cPCI/PCI-6208V is a high-density analog output card with 8 identical voltage output channels. Each channel is equipped with BB.PCM56U, which is a state-of-the-art fully monotonic, digital to analog converter. This device employs ultra-stable nichrome (NiCr) thin-film resistors to provide monotonicity, low distortion, and low differential linearity error over long period of time.

cPCI-6216V, PCI-6216V:

cPCI/PCI-6216V is a high-density analog voltage output card, it is a combination of cPCI/PCI-6208 with EXP-8V daughter board. The EXP-8V is an extended board which includes extra 8 voltage output channels.

cPCI-6208A, PCI-6208A:

cPCI/PCI-6208A is a high-density current source output card, it is a combination of cPCI/PCI-6208V with EXP-8A daughter board. The EXP-8A includes 8 precision voltage-to-current converters, which convert voltage outputs from cPCI/PCI-6208V to current source outputs.

1.1 Features

- 32-bit cPCI/PCI-Bus, Plug and Play
- 16-bit high resolution voltage outputs
- Output Range: $\pm 10V$ (14-bit resolution guarantee) for cPCI/PCI-6208V and PCI-6216V only
- Output Range: 0-20mA, 4-20mA, 5-25mA (14-bit resolution guarantee) for cPCI/PCI-6208A only
- 0.001% of FSR typical. Differential linearity error
- Fast 2 μs voltage settling time (-10V~+10V)
- On board DC-to-DC converter to provide stable power and current source for analog outputs

1.2 Applications

- Industrial Process Control
- Pressure/Temperature Transmitter
- Current Source for Testing Equipment
- Function Generator

1.3 Specifications

◆ Voltage Output

- Numbers of channel:
 - 8 channels for cPCI/PCI-6208V and cPCI/PCI-6208A
 - 16 channels for PCI-6216V
- Converter: B.B. PCM56U or equivalent
- Conversion type: Monolithic multiplying
- Resolution: 16-bit (14-bit guarantee)
- Voltage output ranges: $\pm 10V$
- Voltage output driving capability: $\pm 5mA$ max.
- Settling time: 2 μ second (-10V to +10V)
- Gain error: $\pm 0.2\%$ (max, without trimming)
- Differential Linearity Error: $\pm 0.001\%$ Full Scale Range
- Output initial status: 0V (after RESET or POWER-ON)
- Data Transfer: Programmed I/O

◆ Current Output

- Numbers of channel: 8 channel for cPCI/PCI-6208A
- Current output range: (programmable)
 - 0~20mA, 4~20mA, 5~25mA.
- Voltage to current converter: B.B. XTR110 or equivalent
- Settling time: 17 μ second (from 0 to 20mA)
- Slew rate: 1.3 mA / μ s
- Non-linearity: ± 0.01 % of Span
- Span error: 0.3% of initial Span
- Output resistance: 10 Ohms maximum
- Output initial status: 0mA (after RESET or POWER-ON)

◆ Digital I/O

- **Channel:** 4 TTL compatible inputs and outputs
- **Input Voltage:**
 - Low: Min. 0V; Max. 0.8V
 - High: Min. +2.0V; Max. 5.5V
- **Input Load:**
 - Low: +0.8V @ -0.2mA max.
 - High: +2.7V @ +20mA max.
- **Output Voltage:**
 - Low: Min. 0V; Max. 0.4V
 - High: Min. +2.4V; Max. 5.5V
- **Driving Capacity:**
 - Low: Max. +0.5V at 8.0mA (Sink)
 - High: Min. 2.7V at 0.4mA (Source)

◆ General Specifications

- Operating temperature: 0° ~ 50°C
- Storage temperature: -20° ~ 80°C
- Humidity: 5 ~95% non-condensing
- Connector: 37-pin D-sub connector (female)
- Bus interface: 32-bit slave PCI bus
- Power consumption:
 - PCI-6208V: +5VDC @ 580mA typical
 - +12VDC @ 70mA typical

- PCI-6208A: +5VDC @ 670mA typical
+12VDC @ 90mA typical
or +12VDC @ 380mA
(when all current output channel is 20mA)
- PCI-6216V: +5VDC @ 1.20 typical
+12VDC @ 110mA typical
- cPCI-6208V: +5VDC @ 560mA typical
+12VDC @ 70mA typical
- cPCI-6208A: +5VDC @ 650mA typical
+12VDC @ 90mA typical
or +12VDC @ 370mA
(when all current output channel is 25mA)
- PCB Dimension: Half-sized
 - PCI series: 172 mm x 105 mm
 - cPCI series: 160 mm x 100 mm

1.4 Software Supporting

ADLINK provides versatile software drivers and packages for users' different approach to built-up a system. We not only provide programming library such as DLL for many Windows systems, but also provide drivers for many software package such as LabVIEW[®], HP VEE[™], DASyLab[™], InTouch[™], InControl[™], ISaGRAF[™], and so on.

All the software options are included in the ADLINK CD. The non-free software drivers are protected with serial licensed code. Without the software serial number, you can still install them and run the demo version for two hours for demonstration purpose. Please contact with your dealer to purchase the formal license serial code.

1.4.1 Programming Library

For customers who are writing their own programs, we provide function libraries for many different operating systems, including:

DOS Library: Borland C/C++ and Microsoft C++, the functions descriptions are included in this user's guide.

Windows 95 DLL: For VB, VC++, Delphi, BC5, the functions descriptions are included in this user's guide.

PCIS-DASK: Include device drivers and DLL for **Windows 98, Windows NT and Windows 2000**. DLL is binary compatible across Windows 98, Windows NT and Windows 2000. That means all applications developed with PCIS-DASK are compatible across Windows 98, Windows NT and Windows 2000. The developing environment can be VB, VC++, Delphi, BC5, or any Windows programming language that allows calls to a DLL. The user's guide and function reference manual of PCIS-DASK are in the CD. Please refer the PDF manual files under \\Manual_PDF\Software\PCIS-DASK

PCIS-DASK/X: Include device drivers and shared library for **Linux**. The developing environment can be Gnu C/C++ or any programming language that allows linking to a shared library. The user's guide and function reference manual of PCIS-DASK/X are in the CD. (\\Manual_PDF\Software\PCIS-DASK-X.)

The above software drivers are shipped with the board. Please refer to the "Software Installation Guide" to install these drivers.

1.4.2 PCIS-LVIEW: LabVIEW® Driver

PCIS-LVIEW contains the VIs, which are used to interface with NI's LabVIEW® software package. The PCIS-LVIEW supports Windows 95/98/NT/2000. The LabVIEW® drivers are free shipped with the board. You can install and use them without license. For detail information about PCIS-LVIEW, please refer to the user's guide in the CD.

(\\Manual_PDF\Software\PCIS-LVIEW)

1.4.3 PCIS-VEE: HP-VEE Driver

The PCIS-VEE includes the user objects, which are used to interface with HP VEE software package. PCIS-VEE supports Windows 95/98/NT. The HP-VEE drivers are free shipped with the board. You can install and use them without license. For detail information about PCIS-VEE, please refer to the user's guide in the CD.

(\\Manual_PDF\Software\PCIS-VEE)

1.4.4 DAQBench™: ActiveX Controls

We suggest the customers who are familiar with ActiveX controls and VB/VC++ programming use the DAQBench™ ActiveX Control components library for developing applications. The DAQBench™ is designed under Windows NT/98. For more detailed information about DAQBench, please refer to the user's guide in the CD.

(\\Manual_PDF\Software\DAQBench\DAQBench Manual.PDF)

1.4.5 DASyLab™ PRO

DASyLab is an easy-to-use software package, which provides easy-setup instrument functions such as FFT analysis. Please contact us to get DASyLab PRO, which include DASyLab and ADLINK hardware drivers.

1.4.6 PCIS-DDE: DDE Server and InTouch™

DDE stands for Dynamic Data Exchange specifications. The PCIS-DDE includes the PCI cards' DDE server. The PCIS-DDE server is included in the ADLINK CD. It needs license. The DDE server can be used in conjunction with any DDE client under Windows NT.

1.4.7 PCIS-ISG: ISaGRAF™ driver

The ISaGRAF WorkBench is an IEC1131-3 SoftPLC control program development environment. The PCIS-ISG includes ADLINK products' target drivers for ISaGRAF under Windows NT environment. The PCIS-ISG is included in the ADLINK CD. It needs license.

1.4.8 PCIS-ICL: InControl™ Driver

PCIS-ICL is the InControl driver which supports the Windows NT. The PCIS-ICL is included in the ADLINK CD. It needs license.

1.4.9 PCIS-OPC: OPC Server

PCIS-OPC is an OPC Server, which can link with the OPC clients. There are many software packages on the market that can provide the OPC clients now. The PCIS-OPC supports the Windows NT. It needs license.

2

Installation

This chapter describes how to install the 6208 series card. Please follow the following steps to complete the installation.

- Check what you have (section 2.1)
- Unpacking (section 2.2)
- Check the PCB and jumper location(section 2.3)
- Install the hardware and setup and jumpers (section 2.4, 2.7)
- Install the software drivers and run utility to test (section 2.5)
- Cabling with external devices (section 2.6, 2.8)

2.1 What You Have

In addition to this *User's Manual*, the package includes the following items:

- 6208 Series Card
- ADLINK CD
- Software Installation Guide

If any of these items is missing or damaged, contact the dealer whom you purchased the product from. Save the shipping materials and carton in case you want to ship or store the product in the future.

2.2 Unpacking

Your 6208 series card contains sensitive electronic components that can be easily damaged by static electricity.

The card should be done on a grounded anti-static mat. The operator should be wearing an anti-static wristband, grounded at the same point as the anti-static mat.

Inspect the card module carton for obvious damage. Shipping and handling may cause damage to your module. Be sure there are no shipping and handling damages on the module before processing.

After opening the card module carton, exact the system module and place it only on a grounded anti-static surface component side up.

Note: DO NOT APPLY POWER TO THE CARD IF IT HAS BEEN DAMAGED.

You are now ready to install your 6208 series card.

2.3 PCB Layout

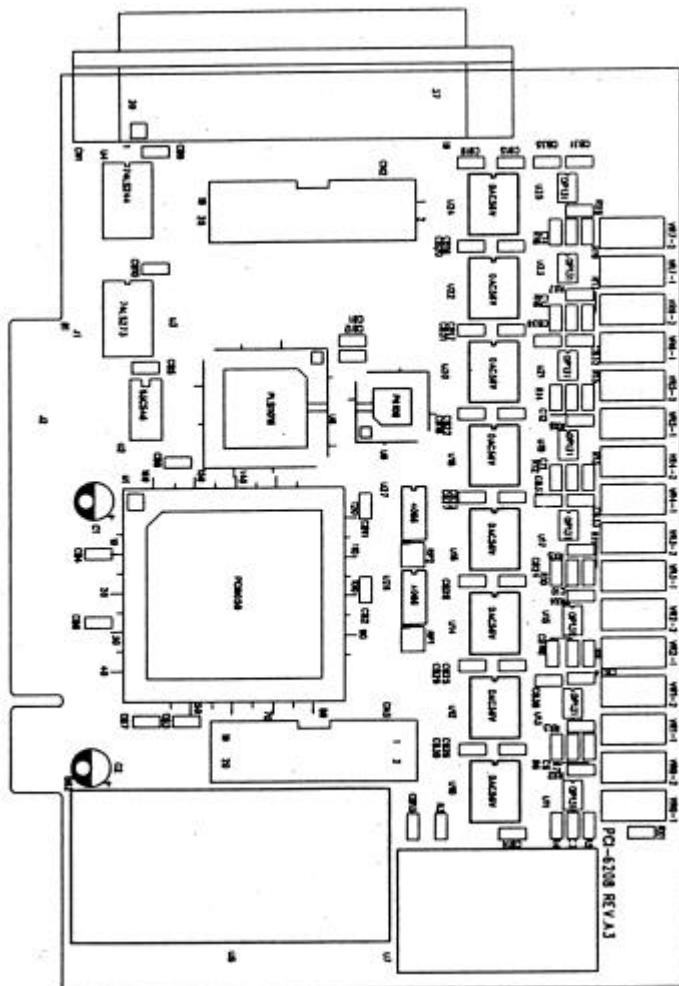

Figure 2.1a PCI-6208 Layout

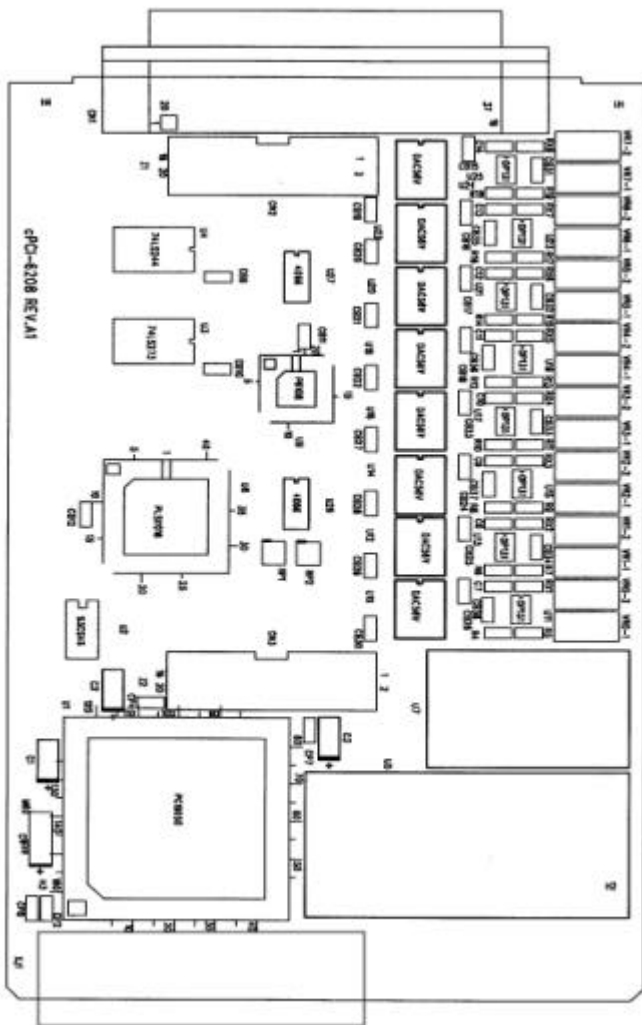

Figure 2.1b cPCI-6208 Layout

2.4 Connector Pin Assignment

The pin assignment of 6208 series card are shown in Figure 2.2

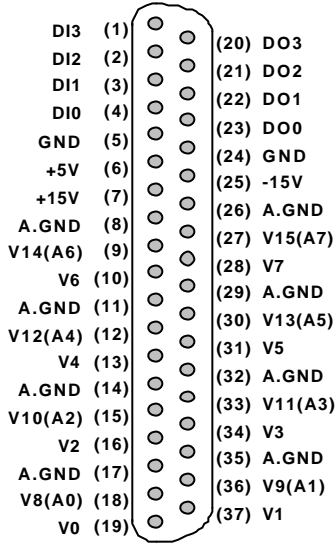

Figure 2.2 Pin Assignment of CN1 connector

The analog output pin names are specified as **Vn** or **An**, where

Vn : means the voltage output with channel number *n*
for cPCI/PCI-6208V, *n*=0~7
for PCI-6216V, *n*=0~15

An : means the current output with channel number *n*
for cPCI/PCI-6208A only, *n*=0~7

The digital input and output pin names are specified as **DIn** and **DO_n** respectively, where *n*=0~3.

2.5 Hardware Installation Outline

Hardware configuration

The PCI cards (or CompactPCI cards) are equipped with plug and play PCI controller, it can request base addresses and interrupt according to PCI standard. The system BIOS will install the system resource based on the PCI cards' configuration registers and system parameters (which are set by system BIOS). Interrupt assignment and memory usage (I/O port locations) of the PCI cards can be assigned by system BIOS only. These system resource assignments are done on a board-by-board basis. It is not suggested to assign the system resource by any other methods.

PCI slot selection

The PCI card can be inserted to any PCI slot without any configuration for system resource. The CompactPCI card can also be inserted to any CompactPCI I/O slot.

Installation Procedures

1. Turn off your computer
2. Turn off all accessories (printer, modem, monitor, etc.) connected to your computer.
3. Remove the cover from your computer.
4. Setup jumpers on the PCI or CompactPCI card.
5. Select a 32-bit PCI slot. PCI slot are short than ISA or EISA slots, and are usually white or ivory.
6. Before handling the PCI cards, discharge any static buildup on your body by touching the metal case of the computer. Hold the edge and do not touch the components.
7. Position the board into the PCI slot you selected.
8. Secure the card in place at the rear panel of the system.

2.6 Device Installation for Windows Systems

Once Windows 95/98/2000 has started, the Plug and Play function of Windows system will find the new NuDAQ/NuIPC cards. If this is the first time to install NuDAQ/NuIPC cards in your Windows system, you will be informed to input the device information source. Please refer to the "**Software Installation Guide**" for the steps of installing the device

2.7 Termination Board Connection

The 6208 series boards are equipped with the DB-37 connector. The available termination boards include:

ACLD-9137: A general purposed 37-pin screw terminal. The ACLD-9137 is with male DB-37 connector, which is used to directly attach on the PCI-6308.

ACLD-9188: A general purposed 37-pin screw terminal, which equipped with heavy-duty screw terminal

DIN-37D: A general purposed 37-pin screw terminal with DIN-socket, which provide the easily installation socket. DIN-37D is shipped with a 37-pin cable

3

Registers Format

The detailed descriptions of the registers format are specified in this chapter. This information is quite useful for the programmers who wish to handle the card by low-level programming. However, we suggest user have to understand more about the PCI interface then start any low-level programming. In addition, the contents of this chapter can help users understand how to use software driver to manipulate this card.

3.1 PCI PnP Registers

This PCI card functions as a 32-bit PCI target device to any master on the PCI bus. There are three types of registers: PCI Configuration Registers (PCR), Local Configuration Registers (LCR) and PCI-6308 registers.

The PCR, which is compliant to the PCI-bus specifications, is initialized and controlled by the plug & play (PnP) PCI BIOS. User's can study the PCI BIOS specification to understand the operation of the PCR. Please contact with PCISIG to acquire the specifications of the PCI interface.

The PCI bus controller PCI-9050 is provided by PLX technology Inc. (www.plxtech.com). For more detailed information of LCR, please visit PLX technology's web site to download relative information. It is not necessary for users to understand the details of the LCR if you use the software library. The PCI PnP BIOS assigns the base address of the LCR. The assigned address is located at offset 14h of PCR.

The PCI-6308 registers are shown in the next section. The base address, which is also assigned by the PCI PnP BIOS, is located at offset 18h of PCR. Therefore, users can read the 18h of PCR to know the base address by using the BIOS function call.

Please do not try to modify the base address and interrupt which assigned by the PCI PnP BIOS, it may cause resource confliction in your system.

3.2 I/O Address Map

There are 8 and 16 voltage output channels for cPCI/PCI-6208V and PCI-6216V respectively. For cPCI/PCI-6208A, there are 8 voltage and current output channels, the voltage output controls the current source. The programming method of all the analog output channels are identical. For the three analog output cPCI/PCI cards, the programming are compatible.

The 6208 registers are all 16 bits. The users can access these registers by 16 bits I/O instructions. The following table shows the address of every analog output ports relative to the base address. Note that the base address is assigned by the PCI BIOS. The current output control of the cPCI/PCI-6208A is described in Section 3.4.

Offset Address	CPCI/PCI-6208V	PCI-6216V	cPCI/PCI-6208A
0x00	V0	V0	V0 / A0
0x02	V1	V1	V1 / A1
0x04	V2	V2	V2 / A2
0x06	V3	V3	V3 / A3
0x08	V4	V4	V4 / A4
0x0A	V5	V5	V5 / A5
0x0C	V6	V6	V6 / A6
0x0E	V7	V7	V7 / A7
0x10	--	V8	--
0x12	--	V9	--
0x14	--	V10	--
0x16	--	V11	--
0x18	--	V12	--
0x1A	--	V13	--
0x1C	--	V14	--
0x1E	--	V15	--

3.3 Analog Output Status Register

The DAC is with series bus hence it take times to send digital value out. The data transfer time for every DA data write takes 2.2 μ s, therefore the software driver must wait for 2.2 μ s before send another data to any analog output port. While the DA value is sending, the Data_Send bit is 'H'. The software driver should check this bit before write any data to output port. This register is read only.

Offset Address	D16~D1	D0
0x00	X	Data_Send

3.4 Digital Output Register

D0~D3 is the digital output signal written to output channel. D4~D7 don't care.

Offset Address	D7	D6	D5	D4	D3	D2	D1	D0
0x40	X	X	X	X	DO3	DO2	DO1	DO0

3.5 Digital Input Register

D4~D7 is digital input signal from CN1.

D0~D3 is read back signal from digital output channel.

Offset Address	D7	D6	D5	D4	D3	D2	D1	D0
0x40	DI3	DI2	DI1	DI0	DO3	DO2	DO1	DO0

4

Operation Theorem

In this chapter, the detail operation theorem of 6208 series cards is described. Before programming or applying the 6208 series cards to your applications, please go through this chapter to understand the features of the functions.

4.1 Voltage Output

The DA converters used on the cPCI/PCI-6208 are Burr-Brown PCM-56U. The DAC is 16 bit resolution with bi-polar output. The voltage output range is +/-10V. Therefore, the data register are all 16-bits value with sign. The digital value range from -32768 (0X8000) to +32767 (0x7FFF) is corresponding to -10 Volt to +10 Volt. Table 3.1 shows the relation between the digital value and the analog output voltage.

When the applications use smaller voltage range, the cPCI/PCI-6208 can still be applied. For example, if the application voltage range is uni-polar 0~5V, the user just use digital value range of 0~16384 with 14 bit voltage resolution.

Digital Value	HEX value	Output Voltage
32767	0x7FFF	+9.99969V
16384	0x4000	+5.00000V
8192	0x2000	+2.50000V
1	0x0001	0.00031V
0	0x0000	0.00000V
-1	0xFFFF	-0.00031V
-8192	0xE000	-2.50000V
-16384	0xC000	-5.00000V
-32767	0x8001	-9.99969V
-32768	0x8000	-10.00000V

4.2 Current Output and Range Control

The current output is implemented by the precision voltage-to-current converter XTR110. The current output channel n (A_n) is control by the voltage of channel n (V_n). The block diagram of the current output channels is shown in Fig 3.1.

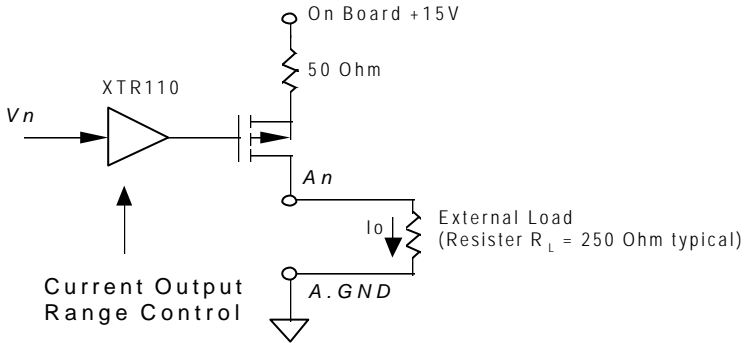

Fig 3.1 Current Output Circuits

The cPCI/PCI-6208A provides an on board +15V power supply. Each current output channel is a current source which is controlled by the voltage of the corresponding channel. For example, voltage output channel 3 control the current source channel 3. The output current range is programmable. All the 8 current channels on cPCI/PCI-6208A are controlled by one control register. The control voltage range is always unipolar 0~10V. There are three kinds of output current range. Refer to the following table and Section 5.2.8 for programming the current range by `_6208_I2V_Control` function.

Mode	Input Voltage Range	Output Current Range
1	0~10V	0~20 mA
2	0~10V	4~20 mA
3	0~10V	5~25 mA

C\C++ Library

This chapter describes the software library for operating this card. Only the functions in DOS library and Windows 95 DLL are described. Please refer to the PCIS-DASK function reference manual, which included in ADLINK CD, for the descriptions of the Windows 98/NT/2000 DLL functions.

The function prototypes and some useful constants are defined in the header files LIB directory (DOS) and INCLUDE directory (Windows 95). For Windows 95 DLL, the developing environment can be Visual Basic 4.0 or above, Visual C/C++ 4.0 or above, Borland C++ 5.0 or above, Borland Delphi 2.x (32-bit) or above, or any Windows programming language that allows calls to a DLL. It provides the C/C++, VB, and Delphi include files.

5.1 Libraries Installation

Please refer to the "**Software Installation Guide**" for the detail information about how to install the software libraries for DOS, or Windows 95 DLL, or PCIS-DASK for Windows 98/NT/2000.

The device drivers and DLL functions of Windows 98/NT/2000 are included in the PCIS-DASK. Please refer the PCIS-DASK user's guide and function reference, which included in the ADLINK CD, for detailed programming information.

5.2 Programming Guide

5.2.1 Naming Convention

The functions of the NuDAQ PCI cards or NuIPC CompactPCI cards' software driver are using full-names to represent the functions' real meaning. The naming convention rules are:

In DOS Environment:

`_{hardware_model}_{action_name}`. e.g. `_6208_Initial()`.

All functions in PCI-6208 driver are with 6208 as {hardware_model}. But they can be used by PCI-6208A, PCI-6208V, PCI-6216V or cPCI-6208A, cPCI-6208V.

In order to recognize the difference between DOS library and Windows 95 library, a capital **W** is put on the head of each function name of the Windows 95 DLL driver. e.g. `W_6208_Initial()`.

5.2.2 Data Types

We defined some data type in `Pci_6208.h` (DOS) and `Acl_pci.h` (Windows 95). These data types are used by NuDAQ Cards' library. We suggest you to use these data types in your application programs. The following table shows the data type names and their range.

Type Name	Description	Range
U8	8-bit ASCII character	0 to 255
I16	16-bit signed integer	-32768 to 32767
U16	16-bit unsigned integer	0 to 65535
I32	32-bit signed integer	-2147483648 to 2147483647
U32	32-bit single-precision floating-point	0 to 4294967295
F32	32-bit single-precision floating-point	-3.402823E38 to 3.402823E38
F64	64-bit double-precision floating-point	-1.797683134862315E308 to 1.797683134862315E309
Boolean	Boolean logic value	TRUE, FALSE

5.3 _6208_Initial

@ Description

This function is used to initialize 6208 series cards. You have to call this function to initialize all 6208 series cards plugged on your system, then you can call other function to perform operations on the cards.

@ Syntax

C/C++ (DOS)

```
U16 _6208_Initial (U16 *existCards, PCI_INFO
*pciInfo)
```

C/C++ (Windows 95)

```
U16 W_6208_Initial (U16 *existCards, PCI_INFO
*pciInfo)
```

Visual Basic (Windows 95)

```
W_6208_Initial (existCards As Integer, pciInfo
As PCI_INFO) As Integer
```

@ Argument

existCards: number of existing 6208 series cards
pciinfo: relative information of the 6208 series cards

@ Return Code

```
ERR_NoError  
ERR_BoardNoInit  
ERR_PCIBiosNotExist
```

5.4 _6208_Software_Reset

@ Description

This function is used to reset the I/O port configuration. Note that this function can not re-start the PCI bus and all the hardware settings won't be changed either.

@ Syntax

C/C++ (DOS)

```
void _6208_Software_Reset (U16 cardNo)
```

C/C++ (Windows 95)

```
void W_6208_Software_Reset (U16 cardNo)
```

Visual Basic (Windows 95)

```
W_6208_Software_Reset (ByVal cardNo As Integer)
```

@ Argument

cardNo: The card number of 6208 series card initialized. The first card (in the most prior PCI slot) is with cardNo = 0.

@ Return Code

```
ERR_NoError
```

5.5 _6208_DA

@ Description

This function is used to write data to D/A converters. There are 8 and 16 Digital-to-Analog conversion channels on the cPCI/PCI-6208 and PCI-6216 respectively. The resolution of each channel is 16 bits with sign; i.e. the digital value range from -32768 (0x8000) to +32767 (0x7FFF). The following table shows the output data format and the relation between the digital value and the analog output voltage:

Digital value	HEX value	Output Voltage
32767	0x7FFF	+9.99969V
16384	0x4000	+5.00000V
8192	0x2000	+2.50000V
1	0x0001	0.00031V
0	0x0000	0.00000V
-1	0xFFFF	-0.00031V
-8192	0xE000	-2.50000V
-16384	0xC000	-5.00000V
-32767	0x8001	-9.99969V
-32768	0x8000	-10.00000V

@ Syntax

C/C++ (DOS)

```
U16 _6208_DA (U16 cardNo, U16 chn, I16 DAData)
```

C/C++ (Windows 95)

```
U16 W_6208_DA (U16 cardNo, U16 chn, I16 DAData)
```

Visual Basic (Windows 95)

```
W_6208_DA (ByVal cardNo As Integer, ByVal chn As Integer, ByVal DAData As Integer) As Integer
```

@ Argument

cardNo: The card number of 6208 series card initialized. The first card (in the most prior PCI slot) is with cardNo = 0.

Chn: D/A channel number

DAData: D/A converted value

@ Return Code

```
ERR_NoError
```

5.6 _6208_Get_DA_Status

@ Description

This function is used to check the DA data sending status. Because the data transfer time for every DA data takes 2.2 μ s, the software driver must wait for 2.2 μ s before sending another data to any analog output port. This function should be called before writing any data to output port. While the DA value is sending, the returned value is "1", otherwise the returned value is "0".

@ Syntax

C/C++ (DOS)

```
U16 _6208_Get_DA_Status (U16 cardNo)
```

C/C++ (Windows 95)

```
U16 W_6208_Get_DA_Status (U16 cardNo)
```

Visual Basic (Windows 95)

```
W_6208_Get_DA_Status (ByVal cardNo As Integer)  
As Integer
```

@ Argument

cardNo: The card number of 6208 series card initialized. The first card (in the most prior PCI slot) is with cardNo = 0.

@ Return Code

```
0 (low): no DA value is sending  
1 (high): the DA value is sending
```

5.7 _6208_DI

@ Description

This function is used to read data from digital input ports. There are 4 digital input channels on 6208 series card. The retrieved value is stored in DIData. However the returned value need to be handled further by including the following code in you program:

```
*DIData = (*DIData&0xF0)>>4
```

@ Syntax

C/C++ (DOS)

```
U16 _6208_DI (U16 cardNo, U16 *DIData)
```

C/C++ (Windows 95)

```
U16 W_6208_DI (U16 cardNo, U16 *DIData)
```

Visual Basic (Windows 95)

```
W_6208_DI (ByVal cardNo As Integer, DIData As Integer) As Integer
```

@ Argument

cardNo:the card number of 6208 series card initialized. The first card (in the most prior PCI slot) is with cardNo = 0.

DIData:the value read from digital input port, please refer to the above description paragraph for getting the correct DI data

@ Return Code

```
ERR_NoError
```

5.8 _6208_DO

@ Description

This function is used to write data to digital output ports. There are 4 digital output channels on 6208 series card, i.e. the output value ranges from 0 to 15.

@ Syntax

C/C++ (DOS)

```
U16 _6208_DO (U16 cardNo, U16 DOData)
```

C/C++ (Windows 95)

```
U16 W_6208_DO (U16 cardNo, U16 DOData)
```

Visual Basic (Windows 95)

```
W_6208_DO (ByVal cardNo As Integer, ByVal  
DOData As Integer) As Integer
```

@ Argument

cardNo:the card number of 6208 series card initialized. The first card (in the most prior PCI slot) is with cardNo = 0.

DOData:the value written to digital output port

@ Return Code

```
ERR_NoError
```

5.9 _6208_I2V_Control

@ Description

This function is used to set cPCI/PCI-6208A voltage-to-current mode control. There are three modes of range for cPCI/PCI-6208A. Please refer to section 3.3 for the detailed description of voltage to current conversion. The three voltage-to-current modes are:

Mode	Input Voltage Range	Output Current Range
I_0to20mA	0~10V	0~20 mA
I_4to20mA	0~10V	4~20 mA
I_5to25mA	0~10V	5~25 mA

@ Syntax

C/C++ (DOS)

```
U16 _6208_I2V_Control (U16 cardNo, U16 ctrl)
```

C/C++ (Windows 95)

```
U16 W_6208_DO (U16 cardNo, U16 DOData)
```

Visual Basic (Windows 95)

```
W_6208_I2V_Control (ByVal cardNo As Integer,  
ByVal ctrl As Integer) As Integer
```

@ Argument

cardNo:the card number of 6208 series card initialized. The first card (in the most prior PCI slot) is with cardNo = 0.

ctrl:the voltage-to-current mode, the valid modes are shown in the above table. The constants are defined in Pci_6208.h (DOS) and Acl_pci.h (Windows 95).

@ Return Code

```
ERR_NoError
```

6

Utility / Calibration

This software CD provides a utility program, 6208util.exe, which provides two functions, Calibration, and Functional Testing. This utility is designed as menu-driven based windowing style. The text messages are shown for operating guidance. This utility is described in the following sections.

6.1 Running the 6208util.exe

After finishing the DOS installation, you can execute the utility by typing as follows (assume your utility is located in \ADLINK\DOS\6208\Util directory)

```
C> cd \ADLINK\DOS\6208\Util
```

```
C> 6208UTIL
```

The following diagram will be displayed on you screen. The message at the bottom of each window guides you how to select item, go to the next step and change the default settings.

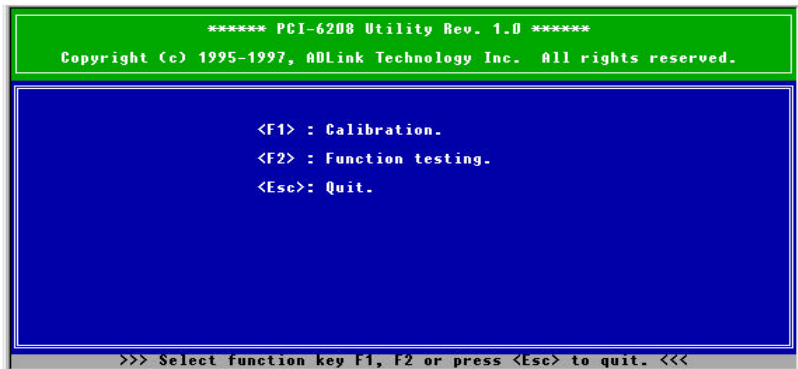

6.1.1 Functional Testing

This function is used to test the D/A functions of cPCI/PCI-6208V /6208A /6216V.

When you choose one of the testing function from the functions menu, a channel selection menu is displayed on the screen. Move cursor and press <Enter> to select the channel you want to test. After you select a channel from the channel selection menu, a testing window appears. The figures below are the function testing menu window, 6208V Testing window.

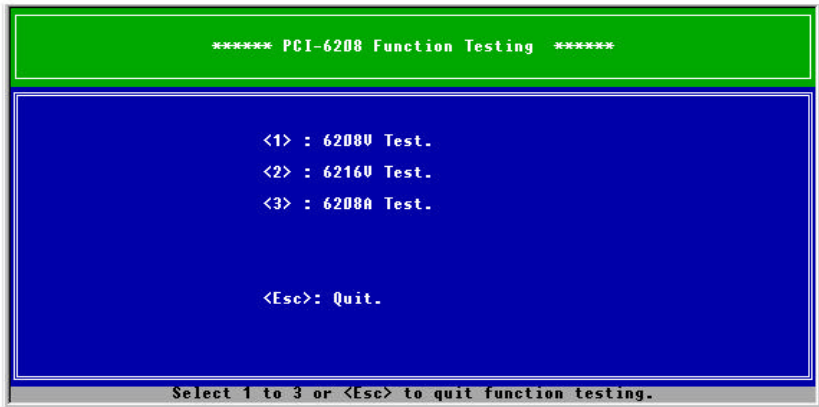

Fig. 6.1 Function Testing Menu Window

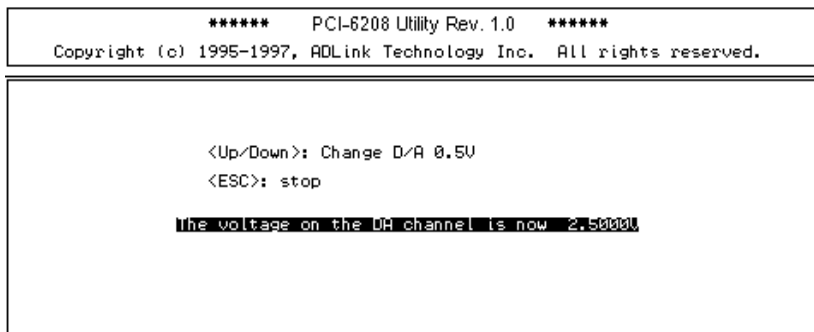

Fig. 6.2 6208V Testing Window

6.1.2 Calibration

This function guides you to calibrate the 6208 series card. The calibration program serves as a useful test of the 6208 series D/A functions and can aid in troubleshooting if problems arise.

Note: For an environment with frequently large changes of temperature and vibration, a 3 months re-calibration interval is recommended. For laboratory conditions, 6 months to 1 year is acceptable

When you choose the calibration function from the main menu list, a calibration items menu is displayed on the screen. After you select one of the calibration items from the calibration items menu, a calibration window shows. The instructions will guide you to calibrate each item step by step.

If you select 1, the following figure displays on the screen:



```
***** PCI-6208 Utility Rev. 1.0 *****
Copyright (c) 1995-1997, ADLink Technology Inc. All rights reserved.
```

Please move cursor to select the channel:

```
1. DA CH0
2. DA CH1
3. DA CH2
4. DA CH3
5. DA CH4
6. DA CH5
7. DA CH6
8. DA CH7
9. EXIT _
```

Use <Up/Down> to select a DA Channel or 'q' to exit

After you select a channel from the channel selection menu, a calibration window appears. The figures below are the 6208V calibration window.

```
***** PCI-6208 Utility Rev. 1.0 *****
Copyright (c) 1995-1997, ADLink Technology Inc. All rights reserved.
```

```
<1>DA CH0 offset : Trim VR0-2 to output 0V
    If OK,press any key to next step
<2>DA CH0 gain : Trin VR0-1 to output +10V and record data as U1
    If OK,press any key to next step
<3>DA CH0 gain : Trim VR0-1 to output -10V and record data as U2
    press <ESC> to next step or any key to repeat step 2 and 3
<4>DA CH0 offset : Trim VR0-2 to output 0V
    If OK,press any key to channel selection window_
```

6.2 Calibration of Analog Output Channel

6.2.1 What You Need

Before calibrating your 6208 series card, you should prepare a 6 1/2 digital multimeter for measuring the voltage signals.

6.2.2 VR Assignemnt of cPCI/PCI-6208 and PCI-6216

There are 8 and 16 voltage output channels on cPCI/PCI-6208 and PCI-6216, respectively. For each channel, two VRs are used for adjustment the full range and offset of the output voltage. The follow table shows the assignment and function of the VRs.

VR of PCI6208V or PCI6216V	Function	VR of PCI6216V	Function
VR0-1	Ch #0 full range	VR8-1	Ch #8 full range
VR0-2	Ch #0 offset	VR8-2	Ch #8 offset
VR1-1	Ch #1 full range	VR9-1	Ch #9 full range
VR1-2	Ch #1 offset	VR9-2	Ch #9 offset
VR2-1	Ch #2 full range	VR10-1	Ch #10 full range
VR2-2	Ch #2 offset	VR10-2	Ch #10 offset
VR3-1	Ch #3 full range	VR11-1	Ch #11 full range
VR3-2	Ch #3 offset	VR11-2	Ch #11 offset
VR4-1	Ch #4 full range	VR12-1	Ch #12 full range
VR4-2	Ch #4 offset	VR12-2	Ch #12 offset
VR5-1	Ch #5 full range	VR13-1	Ch #13 full range
VR5-2	Ch #5 offset	VR13-2	Ch #13 offset
VR6-1	Ch #6 full range	VR14-1	Ch #14 full range
VR6-2	Ch #6 offset	VR14-2	Ch #14 offset
VR7-1	Ch #7 full range	VR15-1	Ch #15 full range
VR7-2	Ch #7 offset	VR15-2	Ch #15 offset

6.2.3 Voltage Output Calibration

Because there is internal reference voltage for every DA channels, the calibration for every channels are independent. In the following procedure, VR_{n-1} and VR_{n-2} is used to represent the full range and offset of the nth channels. The following is the calibration procedure of the DA output.

- Step 1.** Connect the nth DA output (V_n) to VDM(+) of the digital multi-meter. Connect the AGND signal to VDM (-).
- Step 2.** Send digital value '0' to DA. Roughly adjust the offset (trim VR_{n-2}) until the VDM value equal to zero.
- Step 3.** Send digital value '32767' to DA. Record VDM value as V1. Send digital value '-32767' to DA. Record VDM value as V2. Adjust the full range (trim VR_{n-1}) until V1-V2 value equal to +20V.
- Step 4.** Send digital value '0' to DA. Precisely adjust the offset (trim VR_{n-2}) until the VDM value equal to zero.

6.2.4 Current Output Calibration

The current output calibration is used only on cPCI/PCI-6208A. Because the current output channel n is controlled by the voltage of channel n, the VR_{n-1} and VR_{n-2} is also used for calibrating the n-th current output channel.

- Step 1.** Connect the n-th current output (A_n) to VDM(A+) of the digital multi-meter. Connect the both junction of the current load (typical 250 ohm) to the VDM (A-) and ground (AGND) respectively.
- Step 2.** Select the current range by S/W program. For example, to set the current range as 4~20 mA.
- Step 3.** Send digital value '0' to DA. Adjust the offset (trim VR_{n-2}) until the current value equal to the minimum value of the current range. For example, adjust to 4mA if the current range is 4~20mA.
- Step 4.** Send digital value '32767' to DA. Adjust the full range (trim VR_{n-1}) until the current value equal to the maximum value of the full range. For example , to adjust to 20 mA if the current range is 4~20mA.
- Step 5.** Repeat step 3 and step 4 until the accuracy is in user application's specifications.

Product Warranty/Service

Seller warrants that equipment furnished will be free from defects in material and workmanship for a period of one year from the confirmed date of purchase of the original buyer and that upon written notice of any such defect, Seller will, at its option, repair or replace the defective item under the terms of this warranty, subject to the provisions and specific exclusions listed herein.

This warranty shall not apply to equipment that has been previously repaired or altered outside our plant in any way as to, in the judgment of the manufacturer, affect its reliability. Nor will it apply if the equipment has been used in a manner exceeding its specifications or if the serial number has been removed.

Seller does not assume any liability for consequential damages as a result from our products uses, and in any event our liability shall not exceed the original selling price of the equipment.

The equipment warranty shall constitute the sole and exclusive remedy of any Buyer of Seller equipment and the sole and exclusive liability of the Seller, its successors or assigns, in connection with equipment purchased and in lieu of all other warranties expressed implied or statutory, including, but not limited to, any implied warranty of merchant ability or fitness and all other obligations or liabilities of seller, its successors or assigns.

The equipment must be returned postage-prepaid. Package it securely and insure it. You will be charged for parts and labor if you lack proof of date of purchase, or if the warranty period is expired.