

SB600-C

System Board User's Manual

Copyright

This publication contains information that is protected by copyright. No part of it may be reproduced in any form or by any means or used to make any transformation/adaptation without the prior written permission from the copyright holders.

This publication is provided for informational purposes only. The manufacturer makes no representations or warranties with respect to the contents or use of this manual and specifically disclaims any express or implied warranties of merchantability or fitness for any particular purpose. The user will assume the entire risk of the use or the results of the use of this document. Further, the manufacturer reserves the right to revise this publication and make changes to its contents at any time, without obligation to notify any person or entity of such revisions or changes.

© 2012. All Rights Reserved.

Trademarks

All trademarks and registered trademarks of products appearing in this manual are the properties of their respective holders.

FCC and DOC Statement on Class B

This equipment has been tested and found to comply with the limits for a Class B digital device, pursuant to Part 15 of the FCC rules. These limits are designed to provide reasonable protection against harmful interference when the equipment is operated in a residential installation. This equipment generates, uses and can radiate radio frequency energy and, if not installed and used in accordance with the instruction manual, may cause harmful interference to radio communications. However, there is no guarantee that interference will not occur in a particular installation. If this equipment does cause harmful interference to radio or television reception, which can be determined by turning the equipment off and on, the user is encouraged to try to correct the interference by one or more of the following measures:

- Reorient or relocate the receiving antenna.
- Increase the separation between the equipment and the receiver.
- Connect the equipment into an outlet on a circuit different from that to which the receiver is connected.
- Consult the dealer or an experienced radio TV technician for help.

Notice:

1. The changes or modifications not expressly approved by the party responsible for compliance could void the user's authority to operate the equipment.
2. Shielded interface cables must be used in order to comply with the emission limits.

Table of Contents

Copyright.....	2
Trademarks.....	2
FCC and DOC Statement on Class B.....	3
About this Manual.....	6
Warranty.....	6
Static Electricity Precautions.....	7
Safety Measures.....	7
About the Package.....	8
Before Using the System Board.....	8
Chapter 1 - Introduction.....	9
Specifications.....	9
Features.....	12
Chapter 2 - Hardware Installation.....	15
System Board Layout.....	15
System Memory.....	16
Installing the DIM Module.....	18
CPU.....	20
Installing the CPU.....	21
Installing the Fan and Heat Sink.....	25
Jumper Settings.....	27
Clear CMOS Data.....	27
PS/2 Power Select.....	28
USB Power Select.....	29
Power-on Select.....	30
COM1/COM2 RS232/RS422/RS485 Select.....	31
COM1/COM2 RS232/Power Select.....	32
Rear Panel I/O Ports.....	33
PS/2 Keyboard/ Mouse Port.....	34
COM (Serial) Ports.....	36
VGA Port.....	37
DVI-I Port.....	38
RJ45 LAN Ports.....	39
USB Ports.....	40
Audio.....	42

I/O Connectors	44
CD-in Internal Audio Connector	44
S/PDIF Connector.....	45
Digital I/O Connectors	46
SATA (Serial ATA) Connectors	47
Cooling Fan Connectors.....	48
Chassis Intrusion Connector	49
Power Connectors	50
Standby Power LED	51
Front Panel Connectors	52
Expansion Slots	53
IDE Connector	54
Battery	56
SDVO Connector	57
SDVO-LVDS Daughterboard (optional)	58
Features.....	58
Dimensions	58
Jumper Settings.....	59
Panel Power Select	59
I/O Connectors	60
LVDS LCD Panel Connector and LCD/Inverter Power Connector	60
Installing the SDVO-LVDS Daughterboard onto the Motherboard....	62
Chapter 3 - BIOS Setup	65
Overview	65
AMI BIOS Setup Utility	67
Main	67
Advanced	68
Chipset	83
Boot	89
Security	90
Save & Exit	91
Updating the BIOS	92
Chapter 4 - Supported Software	93
Appendix A - NLITE and AHCI Installation Guide	115
Appendix B - Watchdog Sample Code	127
Appendix C - System Error Message	128
Appendix D - Troubleshooting	130

About this Manual

An electronic file of this manual is included in the CD. To view the user's manual in the CD, insert the CD into a CD-ROM drive. The autorun screen (Main Board Utility CD) will appear. Click "User's Manual" on the main menu.

Warranty

1. Warranty does not cover damages or failures that arised from misuse of the product, inability to use the product, unauthorized replacement or alteration of components and product specifications.
2. The warranty is void if the product has been subjected to physical abuse, improper installation, modification, accidents or unauthorized repair of the product.
3. Unless otherwise instructed in this user's manual, the user may not, under any circumstances, attempt to perform service, adjustments or repairs on the product, whether in or out of warranty. It must be returned to the purchase point, factory or authorized service agency for all such work.
4. We will not be liable for any indirect, special, incidental or consequential damages to the product that has been modified or altered.

Static Electricity Precautions

It is quite easy to inadvertently damage your PC, system board, components or devices even before installing them in your system unit. Static electrical discharge can damage computer components without causing any signs of physical damage. You must take extra care in handling them to ensure against electrostatic build-up.

1. To prevent electrostatic build-up, leave the system board in its anti-static bag until you are ready to install it.
2. Wear an antistatic wrist strap.
3. Do all preparation work on a static-free surface.
4. Hold the device only by its edges. Be careful not to touch any of the components, contacts or connections.
5. Avoid touching the pins or contacts on all modules and connectors. Hold modules or connectors by their ends.



Important:

Electrostatic discharge (ESD) can damage your processor, disk drive and other components. Perform the upgrade instruction procedures described at an ESD workstation only. If such a station is not available, you can provide some ESD protection by wearing an antistatic wrist strap and attaching it to a metal part of the system chassis. If a wrist strap is unavailable, establish and maintain contact with the system chassis throughout any procedures requiring ESD protection.

Safety Measures

To avoid damage to the system:

- Use the correct AC input voltage range.

To reduce the risk of electric shock:

- Unplug the power cord before removing the system chassis cover for installation or servicing. After installation or servicing, cover the system chassis before plugging the power cord.

Battery:

- Danger of explosion if battery incorrectly replaced.
- Replace only with the same or equivalent type recommend by the manufacturer.
- Dispose of used batteries according to local ordinance.

About the Package

The system board package contains the following items. If any of these items are missing or damaged, please contact your dealer or sales representative for assistance.

- One motherboard
- One PS/2 Keyboard/ Mouse cable (optional)
- Two USB port cables (with bracket)
- One IDE cable
- Two COM port cables (with bracket)
- Two Serial ATA data cables
- One I/O shield
- One DVD
- One QR (Quick Reference)

The system board and accessories in the package may not come similar to the information listed above. This may differ in accordance to the sales region or models in which it was sold. For more information about the standard package in your region, please contact your dealer or sales representative.

Before Using the System Board

Before using the system board, prepare basic system components.

If you are installing the system board in a new system, you will need at least the following internal components.

- A CPU
- Memory module
- Storage devices such as hard disk drive, CD-ROM, etc.

You will also need external system peripherals you intend to use which will normally include at least a keyboard, a mouse and a video display monitor.

Chapter 1 - Introduction

Specifications

Processor	<ul style="list-style-type: none">• LGA 1155 socket for:<ul style="list-style-type: none">- Intel® Core™ i7-2600 (8M Cache, up to 3.8 GHz); 95W- Intel® Core™ i5-2400 (6M Cache, up to 3.4 GHz); 95W- Intel® Core™ i3-2120 (3M Cache, 3.3 GHz); 65W- Intel® Pentium® G850 (3M Cache, 2.9 GHz); 65W• New microarchitecture on 32nm process technology• Intel® Advanced Vector Extensions (Intel® AVX) Instructions• Intel® Turbo Boost Technology
Chipset	<ul style="list-style-type: none">• Intel® B65 PCH (Platform Controller Hub)
System Memory	<ul style="list-style-type: none">• Four 240-pin DDR3 DIMM sockets• Supports DDR3 1066/1333MHz• Supports dual channel memory interface• Supports up to 32GB system memory• DRAM device technologies: 1Gb, 2GB and 4Gb DDR3 DRAM technologies are supported for x8 and x16 devices, unbuffered, non-ECC
Expansion Slots	<ul style="list-style-type: none">• 1 PCIe x16 slot (PCIe 2.0)• 1 Mini PCIe x1 slot (PCIe 2.0)• 6 PCI slots (PCI 2.3)
Graphics	<ul style="list-style-type: none">• Intel® HD Graphics• Display ports: DVI-I (DVI-D signal) and VGA• DVI-I supports up to 1920x1200 @ 60Hz resolution• VGA supports up to 2048x1536 @ 75Hz resolution• Supports 6 Graphics Execution Units (EUs)• Intel® Clear Video Technology• DirectX Video Acceleration (DXVA) support for accelerating video processing
Audio	<ul style="list-style-type: none">• Realtek ALC886 5.1-channel High Definition Audio• Audio outputs: Mic-in/Center+subwoofer, line-in/surround and line-out• S/PDIF audio interface
LAN	<ul style="list-style-type: none">• 2 Realtek RTL8111DL PCI Express Gigabit Ethernet controllers• Integrated 10/100/1000 transceiver• Fully compliant with IEEE 802.3, IEEE 802.3u, IEEE 802.3ab• Supports wire management
Serial ATA	<ul style="list-style-type: none">• 6 Serial ATA ports<ul style="list-style-type: none">- 5 SATA 2.0 ports with data transfer rate up to 3Gb/s- 1 SATA 3.0 port with data transfer rate up to 6Gb/s• Integrated Advanced Host Controller Interface (AHCI) controller

TPM (optional)	<ul style="list-style-type: none"> • TPM - Trusted Platform Module • Provides a Trusted PC for secure transactions • Provides software license protection, enforcement and password protection
Rear Panel I/O Ports	<ul style="list-style-type: none"> • 1 mini-DIN-6 port for PS/2 mouse/keyboard • 2 DB-9 serial ports <ul style="list-style-type: none"> - Supports RS232/422/485 (RS232 and/or Power) • 1 DB-15 VGA port • 1 DVI-I port (DVI-D signal) • 2 RJ45 LAN ports • 6 USB 2.0/1.1 ports • Line-in/Surround, Line-out, Mic-in/Center+Subwoofer jacks
I/O Connectors	<ul style="list-style-type: none"> • 2 connectors for 4 external USB 2.0/1.1 ports • 4 connectors for 4 external RS232 serial ports • 1 SDVO connector for the optional SDVO-LVDS daughter-board • 1 8-bit Digital I/O connector • 1 front audio connector for line-out and mic-in jacks • 1 CD-in connector • 1 S/PDIF connector • 6 Serial ATA ports • 1 IDE connector • 1 24-pin ATX power connector • 1 8-pin 12V power connector • 1 chassis intrusion connector • 1 front panel connector • 3 fan connectors
BIOS	<ul style="list-style-type: none"> • AMI BIOS • 64Mbit SPI BIOS
Energy Efficient Design	<ul style="list-style-type: none"> • Supports ErP Lot6 power saving (optional) • Supports ACPI • System Power Management • Wake-On-Events include: <ul style="list-style-type: none"> - Wake-On-PS/2 KB/Mouse - Wake-On-USB KB/Mouse - Wake-On-LAN - RTC timer to power-on the system • CPU stopped clock control • AC power failure recovery
Damage Free Intelligence	<ul style="list-style-type: none"> • Monitors CPU/system temperature and overheat alarm • Monitors V_{CORE}/5V/3.3V/V_{DIMM}/12V/5V_{SB} voltages and failure alarm • Monitors CPU/system fan speed and failure alarm • Read back capability that displays temperature, voltage and fan speed • Watchdog timer function

Temperature	<ul style="list-style-type: none">• Operating: 0°C to 60°C• Storage: -20°C to 85°C
Humidity	<ul style="list-style-type: none">• 10% to 90%
PCB	<ul style="list-style-type: none">• ATX form factor• 305mm (12") x 244mm (9.6")

Features

Watchdog Timer

The Watchdog Timer function allows your application to regularly “clear” the system at the set time interval. If the system hangs or fails to function, it will reset at the set time interval so that your system will continue to operate.

DDR3

DDR3 delivers increased system bandwidth and improved performance. It offers peak data transfer rate of up to 21 Gb/s bandwidth. The advantages of DDR3 are its higher bandwidth and its increase in performance at a lower power than DDR2.

Graphics

The integrated Intel HD graphics for graphics intensive applications delivers exceptional 3D, 2D and video capabilities. It supports VGA and DVI interfaces.

DVI

DVI (Digital Visual Interface) is a form of video interface technology made to maximize the quality of flat panel LCD monitors and modern video graphics cards. Data is transmitted using the TMDS (Transition Minimized Differential Signaling) protocol, providing a digital signal from the PC’s graphics subsystem to the display.

PCI Express

PCI Express is a high bandwidth I/O infrastructure that possesses the ability to scale speeds by forming multiple lanes. The x4 PCI Express lane supports transfer rate of 1 Gigabyte per second. The PCI Express architecture also provides a high performance graphics infrastructure by enhancing the capability of a x16 PCI Express lane to provide 8 Gigabytes per second transfer rate.

Audio

The Realtek ALC886 audio codec provides 5.1-channel High Definition audio output.

Serial ATA

Serial ATA is a storage interface that is compliant with SATA 1.0a specification. SATA 3.0 supports speed up to 6Gb/s while SATA 2.0 supports speed up to 3Gb/s. This improves hard drive performance faster than the standard parallel ATA whose data transfer rate is 100MB/s.

Gigabit LAN

The Realtek RTL8111DL PCI Express Gigabit Ethernet controller supports up to 1Gbps data transmission.

USB

The system board supports USB 2.0 and USB 1.1 ports. USB 1.1 supports 12Mb/second bandwidth while USB 2.0 supports 480Mb/second bandwidth providing a marked improvement in device transfer speeds between your computer and a wide range of simultaneously accessible external Plug and Play peripherals.

Wake-On-LAN

This feature allows the network to remotely wake up a Soft Power Down (Soft-Off) PC. It is supported via the onboard LAN port or via a PCI LAN card that uses the PCI PME (Power Management Event) signal. However, if your system is in the Suspend mode, you can power-on the system only through an IRQ or DMA interrupt.

**Important:**

The +5V_standby power source of your power supply must support $\geq 720\text{mA}$.

Wake-On-PS/2

This function allows you to use the PS/2 keyboard or PS/2 mouse to power-on the system.

**Important:**

The +5V_standby power source of your power supply must support $\geq 720\text{mA}$.

Wake-On-USB

This function allows you to use a USB keyboard or USB mouse to wake up a system from the S3 (STR - Suspend To RAM) state.

**Important:**

If you are using the Wake-On-USB Keyboard/Mouse function for 2 USB ports, the +5V_standby power source of your power supply must support $\geq 1.5\text{A}$. For 3 or more USB ports, the +5V_standby power source of your power supply must support $\geq 2\text{A}$.

RTC Timer

The RTC installed on the system board allows your system to automatically power-on on the set date and time.

ACPI STR

The system board is designed to meet the ACPI (Advanced Configuration and Power Interface) specification. ACPI has energy saving features that enables PCs to implement Power Management and Plug-and-Play with operating systems that support OS Direct Power Management. ACPI when enabled in the Power Management Setup will allow you to use the Suspend to RAM function.

With the Suspend to RAM function enabled, you can power-off the system at once by pressing the power button or selecting "Standby" when you shut down Windows® without having to go through the sometimes tiresome process of closing files, applications and operating system. This is because the system is capable of storing all programs and data files during the entire operating session into RAM (Random Access Memory) when it powers-off. The operating session will resume exactly where you left off the next time you power-on the system.



Important:

The +5V_standby power source of your power supply must support $\geq 720\text{mA}$.

Power Failure Recovery

When power returns after an AC power failure, you may choose to either power-on the system manually or let the system power-on automatically.

Chapter 2 - Hardware Installation

System Board Layout

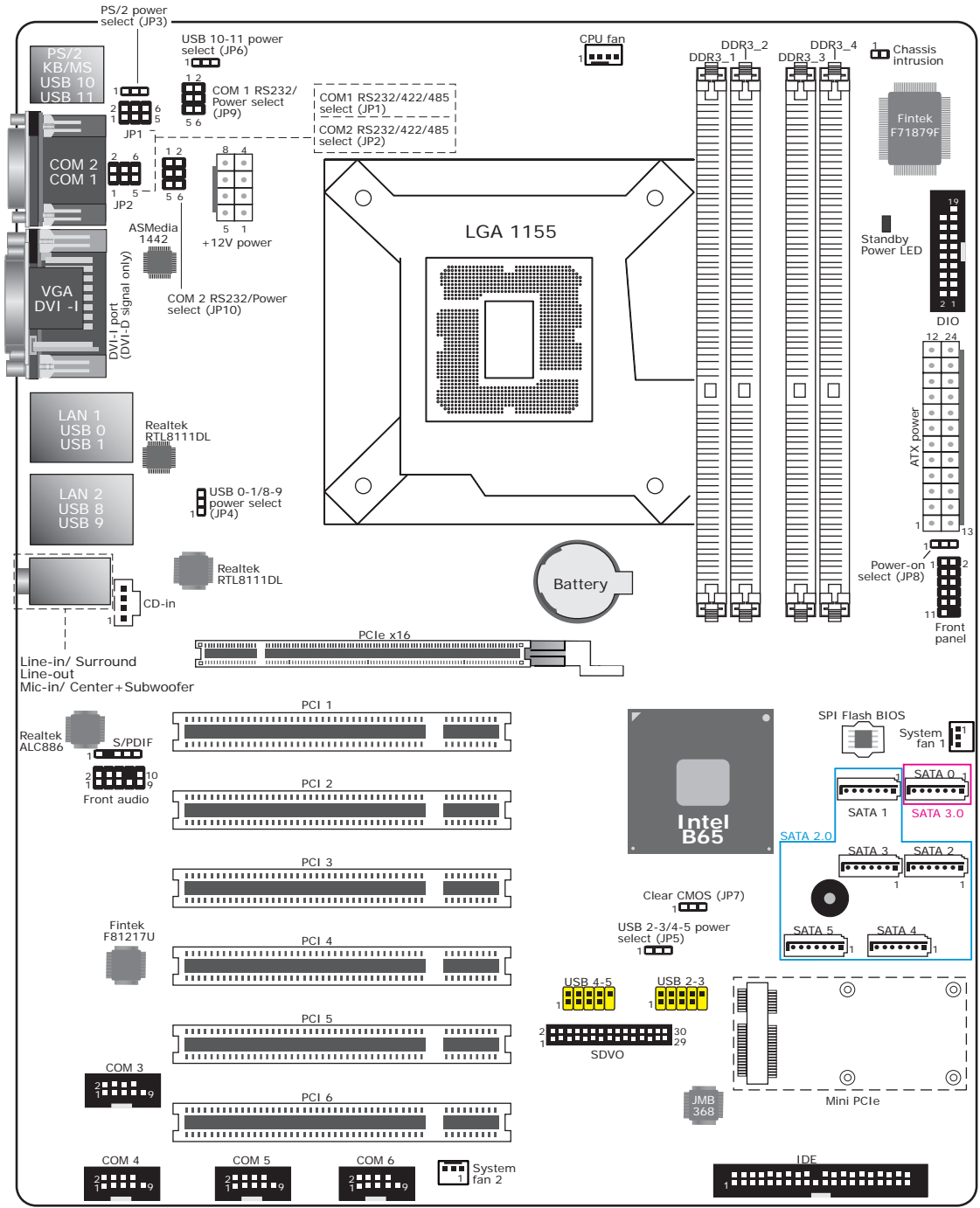

**Important:**

Electrostatic discharge (ESD) can damage your system board, processor, disk drives, add-in boards, and other components. Perform the upgrade instruction procedures described at an ESD workstation only. If such a station is not available, you can provide some ESD protection by wearing an antistatic wrist strap and attaching it to a metal part of the system chassis. If a wrist strap is unavailable, establish and maintain contact with the system chassis throughout any procedures requiring ESD protection.

System Memory

**Important:**

When the Standby Power LED lit red, it indicates that there is power on the system board. Power-off the PC then unplug the power cord prior to installing any devices. Failure to do so will cause severe damage to the motherboard and components.

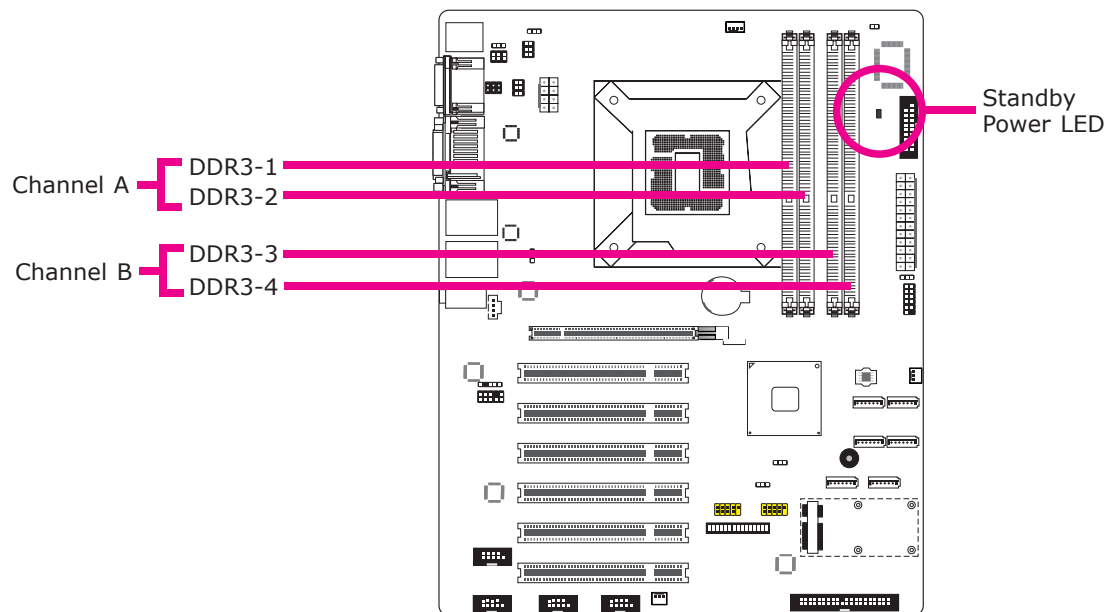

Features

- The four DIMM sockets are divided into 2 channels:
 - Channel A - DDR3_1 and DDR3_2
 - Channel B - DDR3_3 and DDR3_4
- Dual channel memory interface
- Maximum of 32GB system memory

The system board supports the following memory interface.

Single Channel (SC)

Data will be accessed in chunks of 64 bits (8B) from the memory channels.

Dual Channel (DC)

Data will be accessed in chunks of 128 bits from the memory channels. Dual channel provides better system performance because it doubles the data transfer rate.

Single Channel	DIMMs are on the same channel. DIMMs in a channel can be identical or completely different. However, we highly recommend using identical DIMMs. Not all slots need to be populated.
Dual Channel	DIMMs of the same memory configuration are on different channels.



Important:

1. You can populate either Channel A or Channel B first.
2. When installing a DIMM in Channel A or Channel B, always populate the socket that is farthest the CPU. In this case, it will mean populating DDR3-2 and/or DDR3-4 first.
3. If you intend to use dual channel, the same rule applies - always the socket farthest the CPU. Populate DDR3-2 and/or DDR3-4 first; not DDR3-2 and DDR3-3 and not DDR3-1 and DDR3-4.

Installing the DIM Module

**Note:**

The system board used in the following illustrations may not resemble the actual board. These illustrations are for reference only.

1. Make sure the PC and all other peripheral devices connected to it has been powered down.
2. Disconnect all power cords and cables.
3. Locate the DIMM socket on the system board.
4. Push the "ejector tabs" which are at the ends of the socket to the side.



5. Note how the module is keyed to the socket.

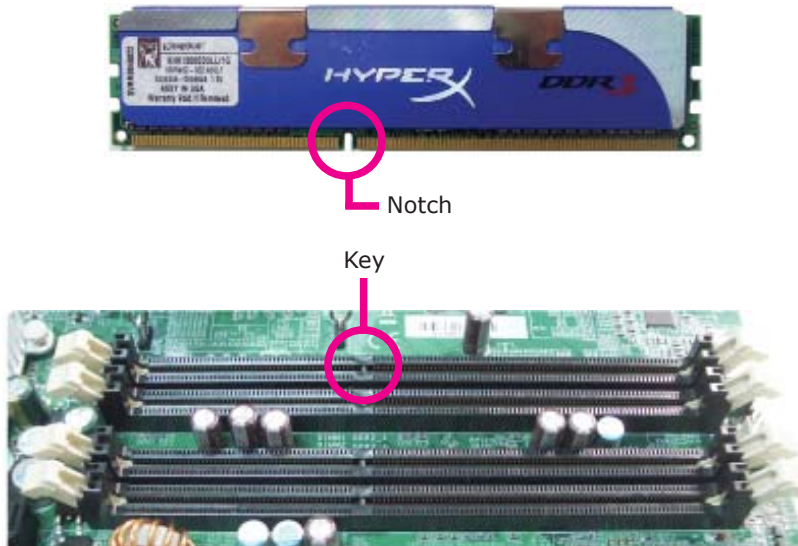

- Grasping the module by its edges, position the module above the socket with the “notch” in the module aligned with the “key” on the socket. The keying mechanism ensures the module can be plugged into the socket in only one way.



- Seat the module vertically, pressing it down firmly until it is completely seated in the socket.



- The ejector tabs at the ends of the socket will automatically snap into the locked position to hold the module in place.



CPU

The system board is equipped with a surface mount LGA 1155 socket. This socket is exclusively designed for installing a LGA 1155 packaged Intel CPU.

**Important:**

1. Before you proceed, make sure (1) the LGA 1155 socket comes with a protective cap, (2) the cap is not damaged and (3) the socket's contact pins are not bent. If the cap is missing or the cap and/or contact pins are damaged, contact your dealer immediately.
2. Make sure to keep the protective cap. RMA requests will be accepted and processed only if the LGA 1155 socket comes with the protective cap.

**Note:**

The system board used in the following illustrations may not resemble the actual board. These illustrations are for reference only.

Installing the CPU

1. Make sure the PC and all other peripheral devices connected to it has been powered down.
2. Disconnect all power cords and cables.
3. Locate the LGA 1155 CPU socket on the system board.

Important:

The CPU socket must not come in contact with anything other than the CPU. Avoid unnecessary exposure. Remove the protective cap only when you are about to install the CPU.

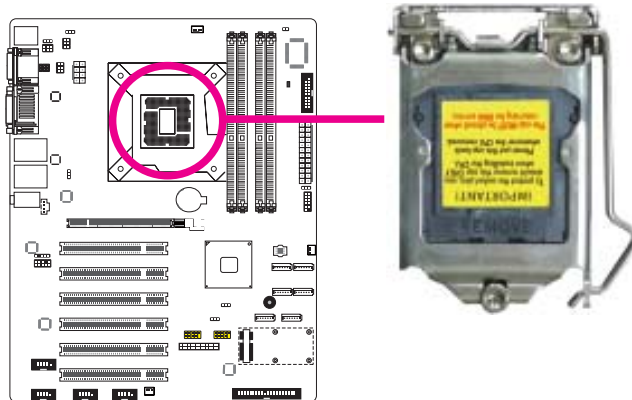

4. Unlock the socket by pushing the load lever down, moving it sideways until it is released from the retention tab; then lift the load lever up.



- Lifting the load lever will at the same time lift the load plate.

Lift the load lever up to the angle shown on the photo.

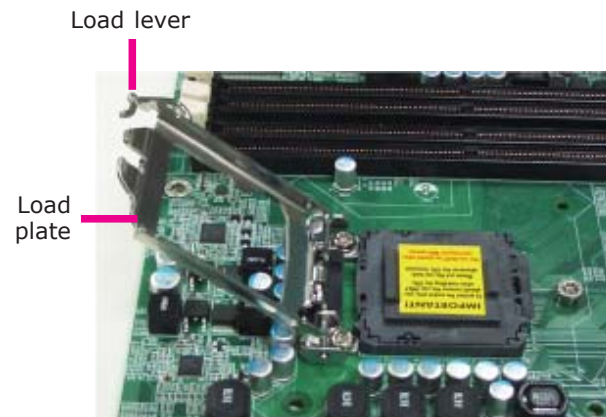

- Remove the protective cap from the CPU socket. The cap is used to protect the CPU socket against dust and harmful particles. Remove the protective cap only when you are about to install the CPU.

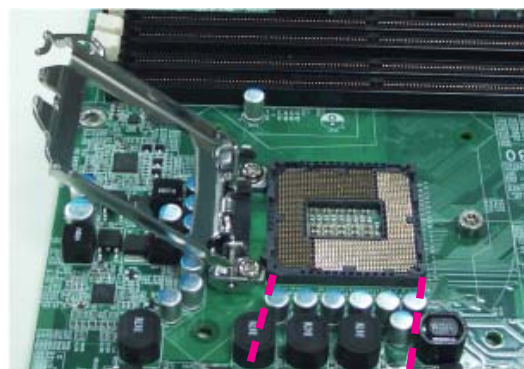

Protective cap

7. Insert the CPU into the socket. The gold triangular mark on the CPU must align with the corner of the CPU socket shown on the photo.

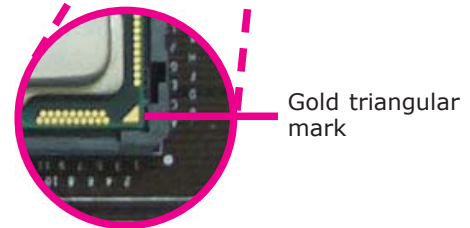

The CPU's notch will at the same time fit into the socket's alignment key.

Important:
The CPU will fit in only one orientation and can easily be inserted without exerting any force.

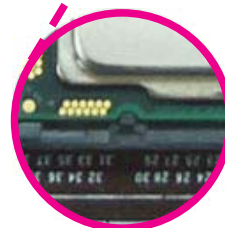
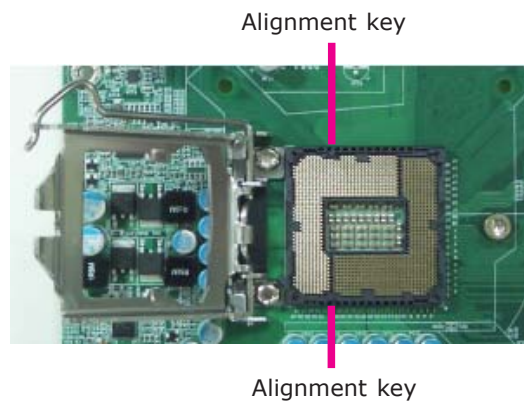

8. Close the load plate then push the load lever down.

While closing the load plate, make sure the front edge of the load plate slides under the retention knob.



Retention knob

9. Hook the load lever under the retention tab.



Load lever

Retention tab

Installing the Fan and Heat Sink

The CPU must be kept cool by using a CPU fan with heat sink. Without sufficient air circulation across the CPU and heat sink, the CPU will overheat damaging both the CPU and system board.

**Note:**

A boxed Intel® processor already includes the CPU fan and heat sink assembly. If your CPU was purchased separately, make sure to only use Intel®-certified fan and heat sink.

1. Before you install the fan / heat sink, you must apply a thermal paste onto the top of the CPU. The thermal paste is usually supplied when you purchase the fan / heat sink assembly. Do not spread the paste all over the surface. When you later place the heat sink on top of the CPU, the compound will disperse evenly.

Some heat sinks come with a patch of pre-applied thermal paste. Do not apply thermal paste if the fan / heat sink already has a patch of thermal paste on its underside. Peel the strip that covers the paste before you place the fan / heat sink on top of the CPU.

2. Place the heat sink on top of the CPU. The 4 push-pins around the heat sink, which are used to secure the heat sink onto the system board, must match the 4 mounting holes around the socket.

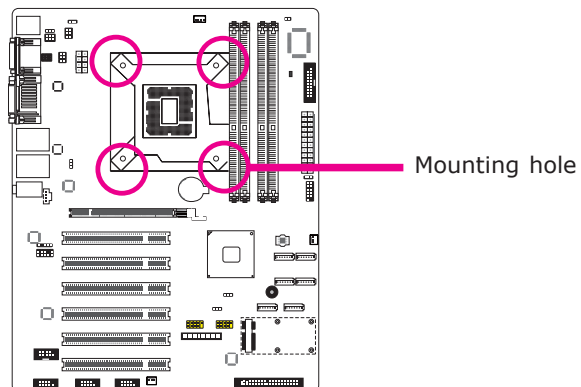

3. Orient the heat sink such that the CPU fan's cable is nearest the CPU fan connector.

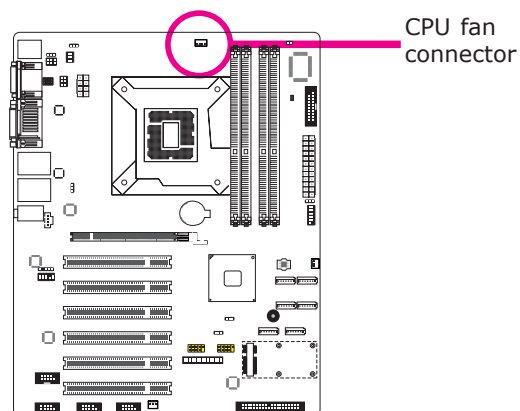

4. Rotate each push-pin according to the direction of the arrow shown on top of the pin.

Push down two pushpins that are diagonally across the heat sink. Perform the same procedure for the other two push-pins.

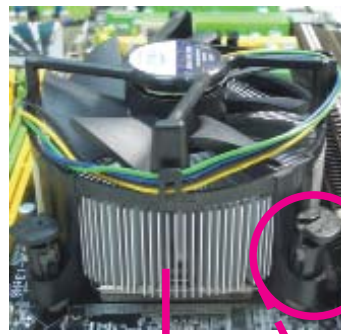

Heat sink



"Locked" position of push-pin



"Unlocked" position of push-pin

5. Connect the CPU fan's cable to the CPU fan connector on the system board.

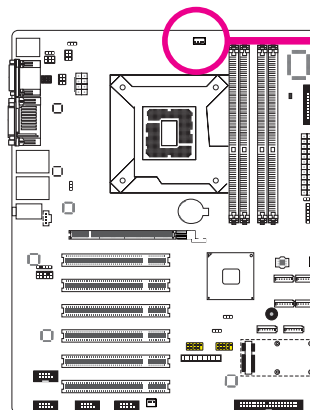

CPU fan connector

Jumper Settings

Clear CMOS Data

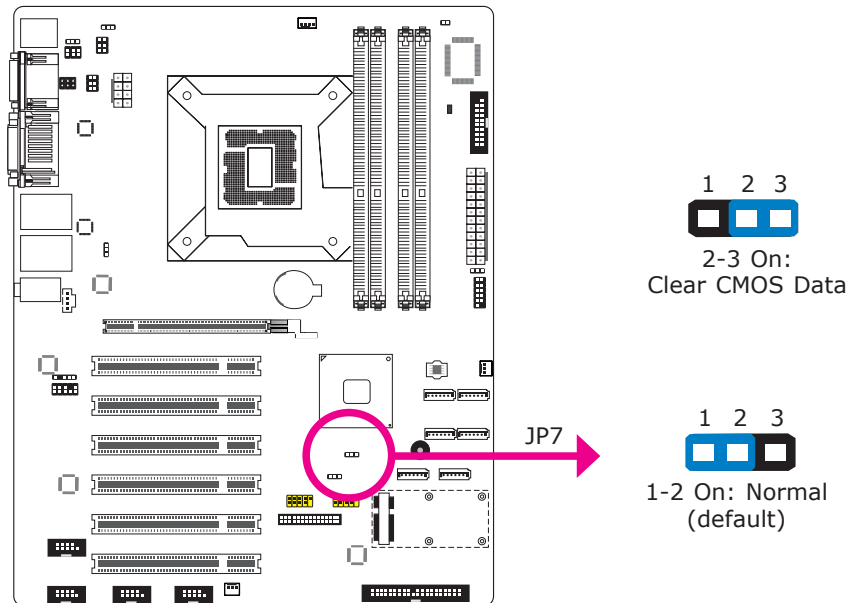

If you encounter the following,

- CMOS data becomes corrupted.
- You forgot the supervisor or user password.

you can reconfigure the system with the default values stored in the ROM BIOS.

To load the default values stored in the ROM BIOS, please follow the steps below.

- Power-off the system and unplug the power cord.
- Set JP7 pins 2 and 3 to On. Wait for a few seconds and set JP7 back to its default setting, pins 1 and 2 On.
- Now plug the power cord and power-on the system.

PS/2 Power Select

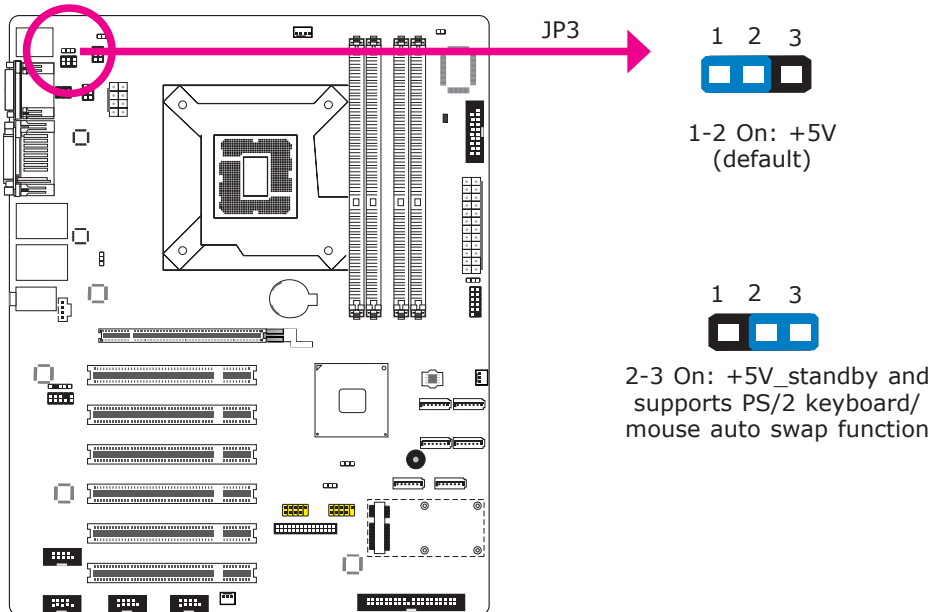

JP3 is used to select the power of the PS/2 keyboard and PS/2 mouse ports. Selecting +5V_standby will allow you to use the PS/2 keyboard or PS/2 mouse to wake up the system.

**Important:**

The +5V_standby power source of your power supply must support $\geq 720\text{mA}$.

**Important:**

If you are using the Wake-On-USB Keyboard/Mouse function for 2 USB ports, the +5V_standby power source of your power supply must support $\geq 1.5\text{A}$. For 3 or more USB ports, the +5V_standby power source of your power supply must support $\geq 2\text{A}$.

By default, the PS/2 port supports PS/2 keyboard only. If you intend to connect a PS/2 mouse, you must set JP3 to 2-3 On. This will support the auto-swap function allowing the system to auto-detect the PS/2 device.

To allow the system to detect devices that may be incorrectly plugged to the wrong port on the cable, set JP3 to 2-3 On. Setting JP3 to 2-3 On will enable the auto-swap function allowing you to use the devices without having to replug the devices.

USB Power Select

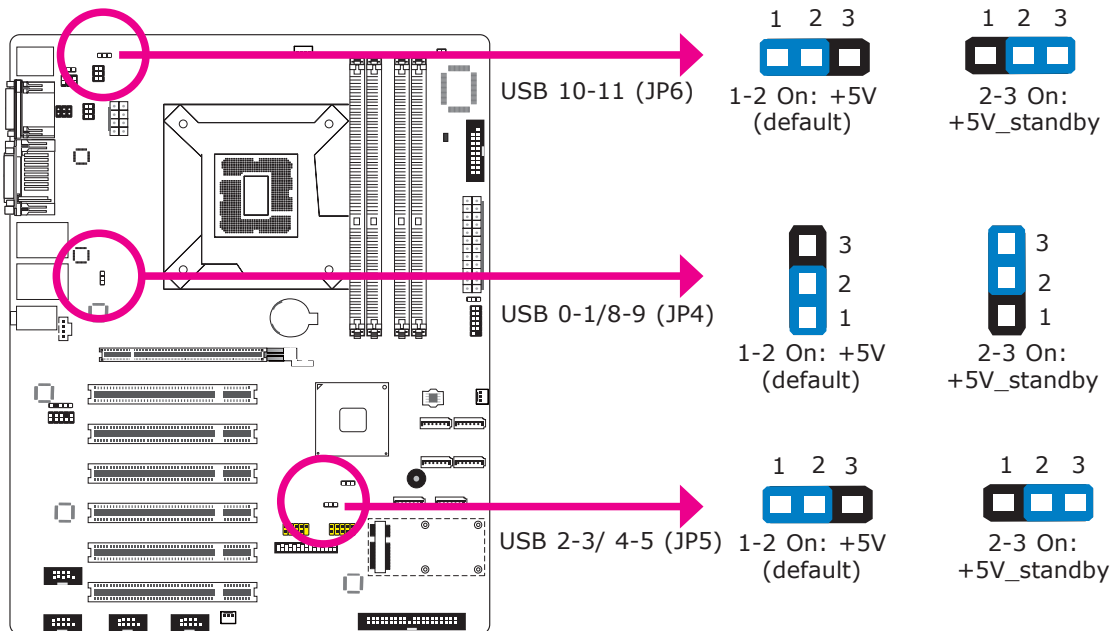

These jumpers are used to select the power of the USB ports. Selecting +5V_standby will allow you to use a USB device to wake up the system.



Important:

If you are using the Wake-On-USB Keyboard/Mouse function for 2 USB ports, the +5V_standby power source of your power supply must support $\geq 1.5A$. For 3 or more USB ports, the +5V_standby power source of your power supply must support $\geq 2A$.

Power-on Select

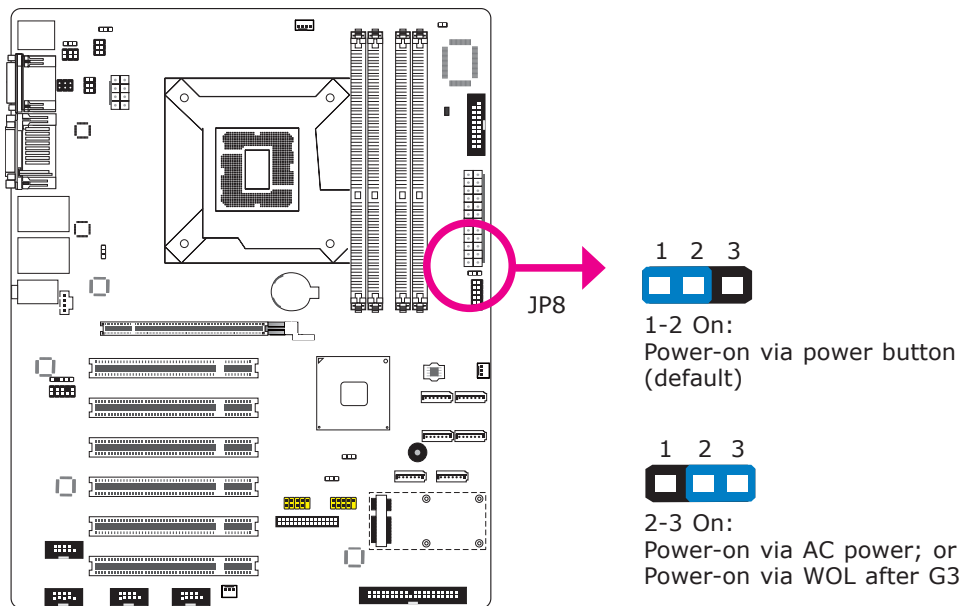

To power-on via WOL after G3:

1. Set JP8 pins 2 and 3 to On.
2. Set the "After G3" field to **Power Off/WOL**.
3. Set the "GbE Wake Up From S5" to **Enabled**.

The BIOS fields are in the "South Bridge Configuration" submenu (Chipset menu) of the AMI BIOS utility.

To power-on via AC Power:

1. Set JP8 pins 2 and 3 to On.
2. Set the "After G3" field to **Power On**.

COM1/COM2 RS232/RS422/RS485 Select

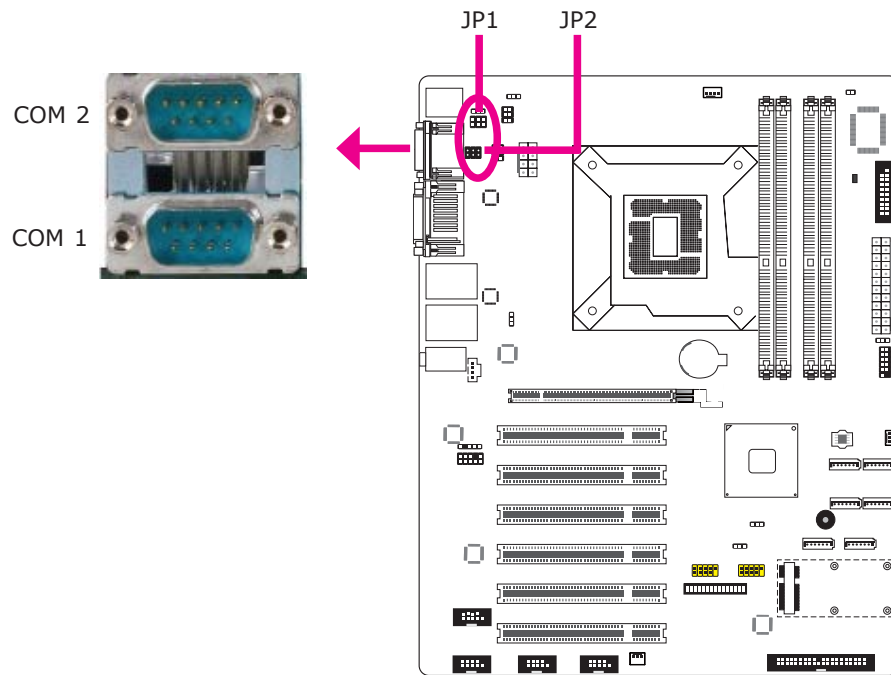



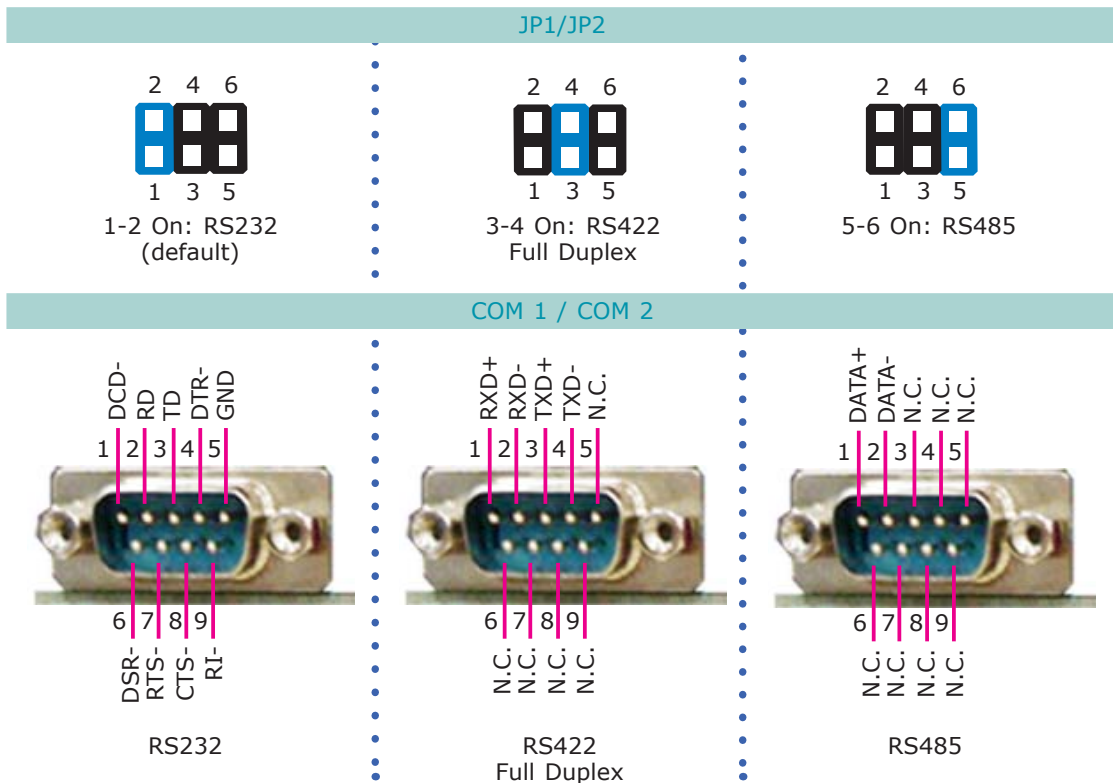

JP1 (for COM1) and JP2 (for COM2) are used to configure the COM ports to RS232, RS422 (Full Duplex) or RS485.

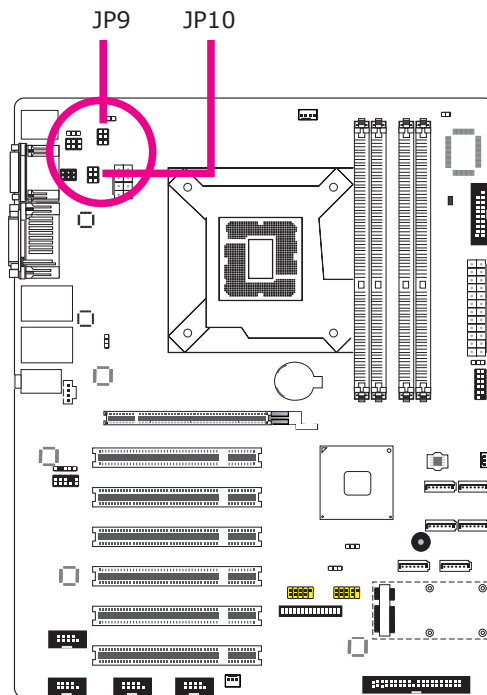

The pin function of the COM ports will vary according to the jumper's setting.



COM1/COM2 RS232/Power Select



- | | | | |
|---|---|---|-------------------------|
| 1 |  | 2 | 1-3 (RI), 2-4 (DCD) On: |
| 3 |  | 4 | RS232 (default) |
| 5 |  | 6 | |

- | | | | |
|---|---|---|---------------------------|
| 1 |  | 2 | 3-5 (+5V), 4-6 (+12V) On: |
| 3 |  | 4 | RS232 with power |
| 5 |  | 6 | |

Rear Panel I/O Ports



The rear panel I/O ports consist of the following:

- PS/2 mouse/ keyboard port
- 2 COM ports
- VGA port
- DVI-I port (DVI-D signal only)
- 2 LAN ports
- 6 USB ports
- Mic-in/ Center+subwoofer jack
- Line-out jack
- Line-in/ Surround jack

PS/2 Keyboard/ Mouse Port

PS/2 Keyboard/
Mouse

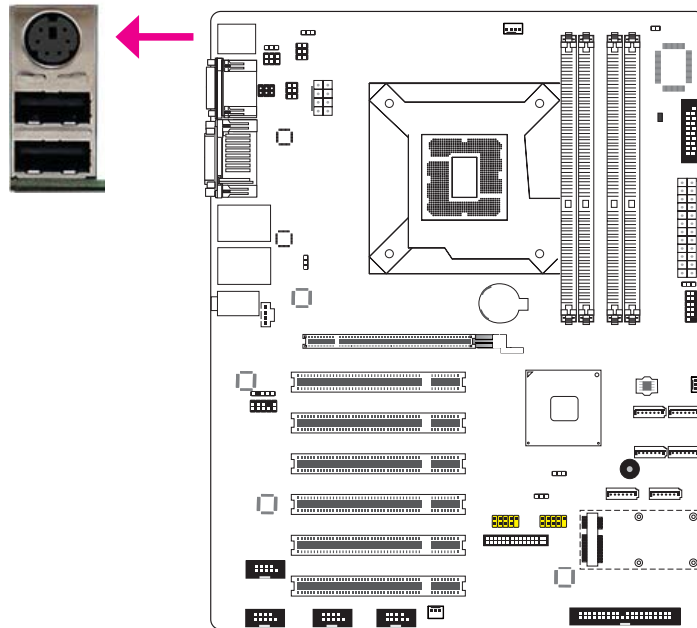

The PS/2 port is used to connect a PS/2 keyboard and a PS/2 mouse by means of the provided cable.

Wake-On-PS/2 Keyboard/ Mouse

The Wake-On-PS/2 Keyboard/ Mouse function allows you to use the PS/2 keyboard or PS/2 mouse to power-on the system. To use this function:

- **Jumper Setting**

JP3 must be set to "2-3 On: +5V_standby". Refer to "PS/2 Power Select" in this chapter for more information.

- **BIOS Setting**

Configure the PS/2 keyboard/mouse wake up function in the Advanced menu ("ACPI Power Management Configuration" submenu) of the BIOS. Refer to chapter 3 for more information.



Important:

The +5V_standby power source of your power supply must support $\geq 720\text{mA}$.

Make sure to turn off your computer prior to connecting or disconnecting a mouse or keyboard. Failure to do so may damage the system board.

**Important:**

By default, the PS/2 port supports PS/2 keyboard only. If you intend to connect a PS/2 mouse, you must set JP3 to 2-3 On. This will support the auto-swap function allowing the system to auto-detect the PS/2 device.

To allow the system to detect devices that may be incorrectly plugged to the wrong port on the cable, set JP3 to 2-3 On. Setting JP3 to 2-3 On will enable the auto-swap function allowing you to use the devices without having to replug the devices.

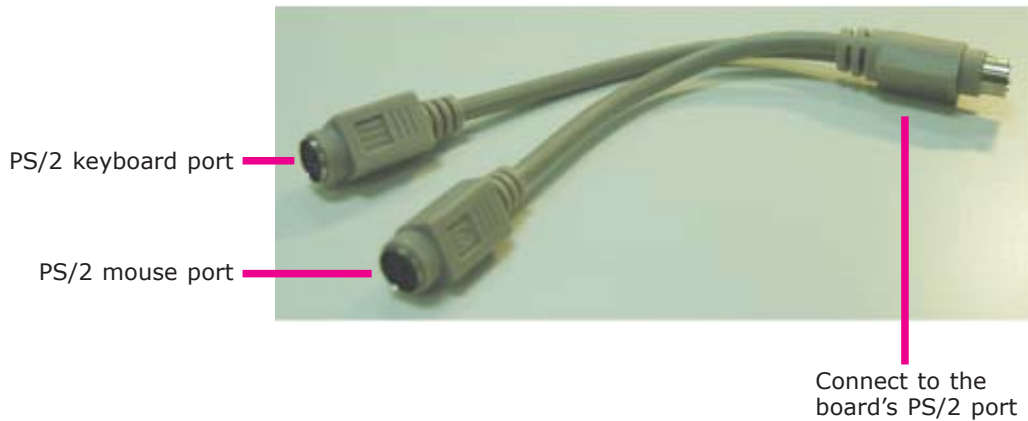

COM (Serial) Ports

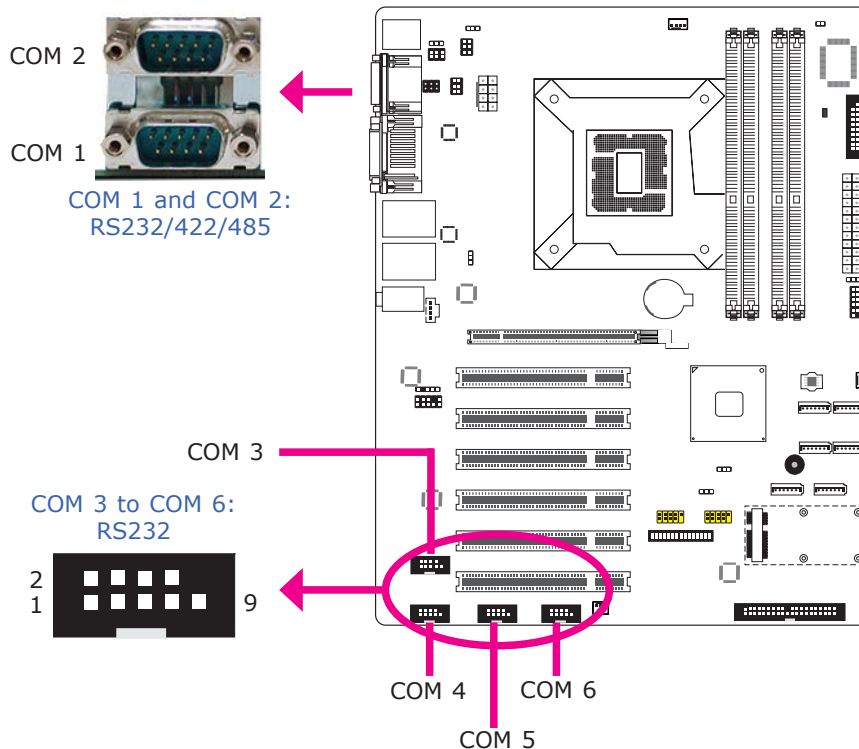

COM 3 to COM 6 are fixed at RS232.

The pin function of COM 1 and COM 2 ports will vary according to JP1/JP2's setting. Refer to "COM1/COM2 RS232/RS422/RS485 Select" in this chapter for more information.

The serial ports are asynchronous communication ports with 16C550A-compatible UARTs that can be used with modems, serial printers, remote display terminals, and other serial devices.

Connecting External Serial Ports

Your COM port may come mounted on a card-edge bracket. Install the card-edge bracket to an available slot at the rear of the system chassis then insert the serial port cable to the COM connector. Make sure the colored stripe on the ribbon cable is aligned with pin 1 of the COM connector.

BIOS Setting

Configure the serial ports in the Advanced menu ("Super IO Configuration" sub-menu) of the BIOS. Refer to chapter 3 for more information.

VGA Port

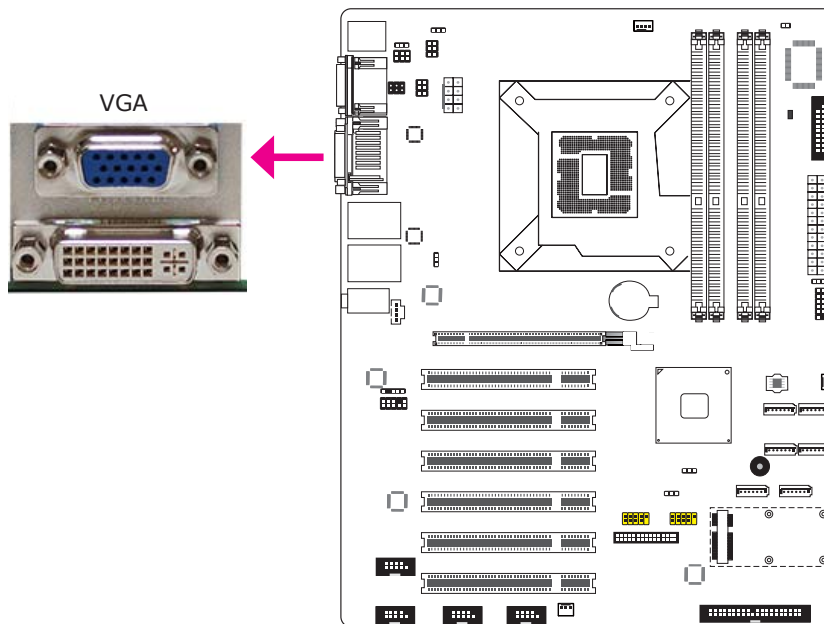

The VGA port is used for connecting a VGA monitor. Connect the monitor's 15-pin D-shell cable connector to the VGA port. After you plug the monitor's cable connector into the VGA port, gently tighten the cable screws to hold the connector in place.

BIOS Setting

Configure VGA in the Chipset menu ("North Bridge Configuration" submenu) of the BIOS. Refer to chapter 3 for more information.

Driver Installation

Install the graphics driver. Refer to chapter 4 for more information.

DVI-I Port

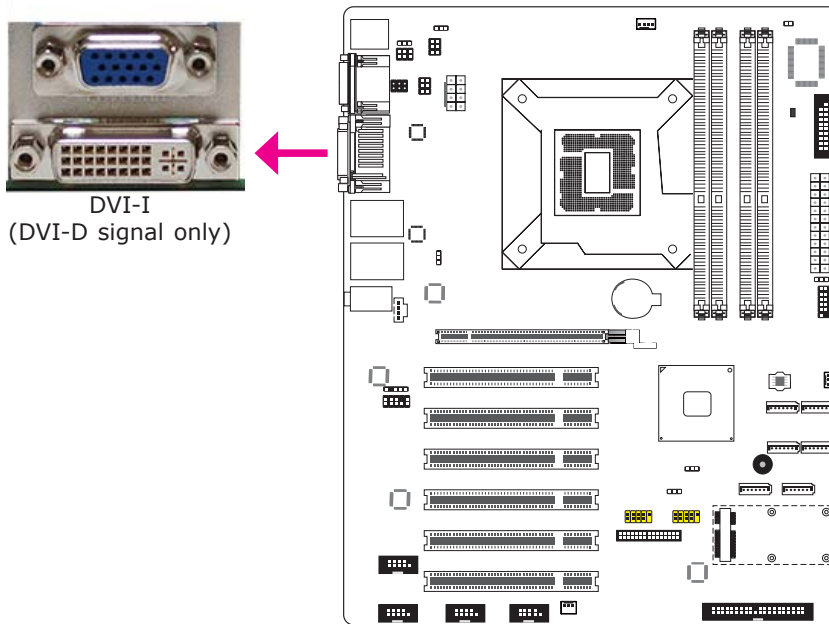

The DVI-I port is used to connect an LCD monitor. This port supports DVI-D signal only.

Connect the display device's cable connector to the DVI-I port. After you plug the cable connector into the port, gently tighten the cable screws to hold the connector in place.

BIOS Setting

Configure the display device in the Chipset menu ("North Bridge Configuration" submenu) of the BIOS. Refer to chapter 3 for more information.

RJ45 LAN Ports

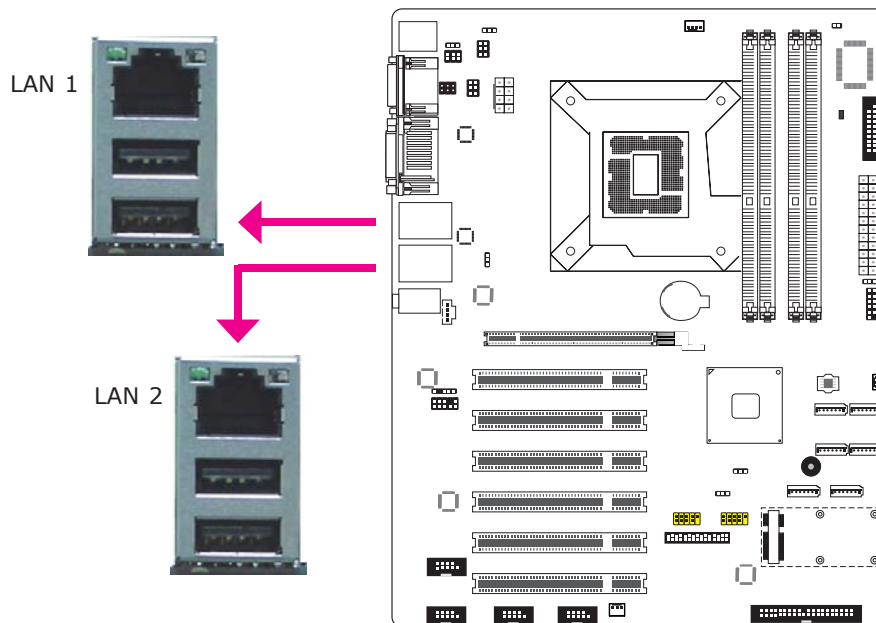

Features

- Realtek RTL8111DL PCI Express Gigabit Ethernet controller

The LAN ports allow the system board to connect to a local area network by means of a network hub.

BIOS Setting

Configure the onboard LAN in the Chipset menu ("South Bridge Configuration" submenu) of the BIOS. Refer to chapter 3 for more information.

Driver Installation

Install the LAN drivers. Refer to chapter 4 for more information.

USB Ports

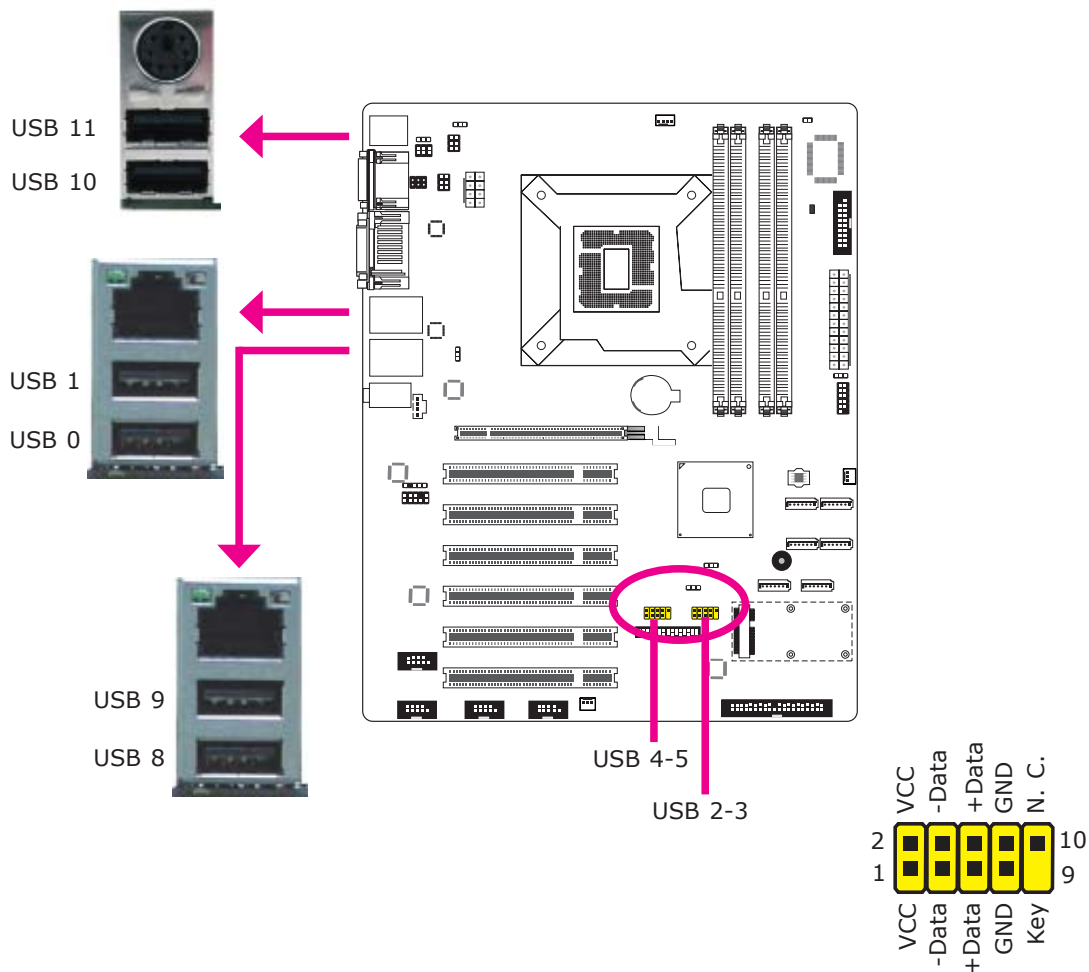

USB allows data exchange between your computer and a wide range of simultaneously accessible external Plug and Play peripherals.

The system board is equipped with four onboard USB 2.0/1.1 ports. The four 10-pin connectors allow you to connect 8 additional USB 2.0/1.1 ports. The additional USB ports may be mounted on a card-edge bracket. Install the card-edge bracket to an available slot at the rear of the system chassis and then insert the USB port cables to a connector.

BIOS Setting

Configure the onboard USB in the Advanced menu ("USB Configuration" sub-menu) of the BIOS. Refer to chapter 3 for more information.

Driver Installation

You may need to install the proper drivers in your operating system to use the USB device. Refer to your operating system's manual or documentation for more information.

Wake-On-USB Keyboard/Mouse

The Wake-On-USB Keyboard/Mouse function allows you to use a USB keyboard or USB mouse to wake up a system from the S3 (STR - Suspend To RAM) state. To use this function:

- **Jumper Setting**

JP3, JP4 and/or JP5 must be set to "2-3 On: +5V_standby". Refer to "USB Power Select" in this chapter for more information.



Important:

If you are using the Wake-On-USB Keyboard/Mouse function for 2 USB ports, the +5V_standby power source of your power supply must support $\geq 1.5A$. For 3 or more USB ports, the +5V_standby power source of your power supply must support $\geq 2A$.

Audio

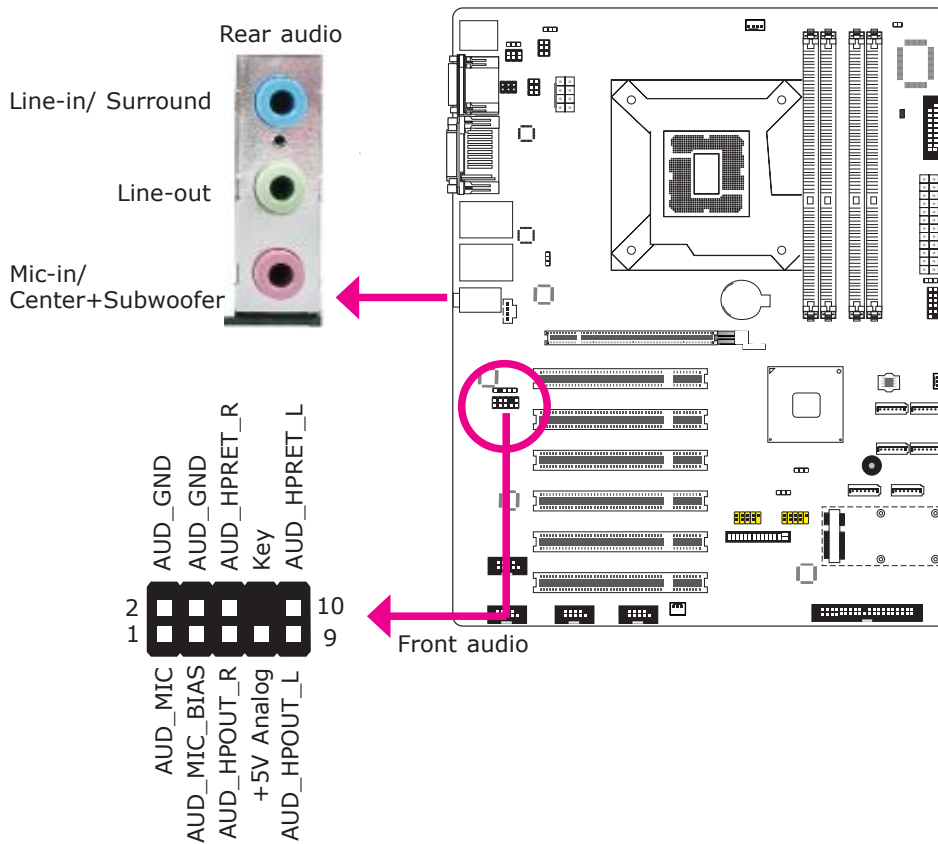

Rear Audio

The system board is equipped with 3 audio jacks. A jack is a one-hole connecting interface for inserting a plug.

- **Mic-in/ Center+Subwoofer Jack (Pink)**
This jack is used to connect an external microphone or to the center and subwoofer speakers of the audio system.
- **Line-in/ Surround Jack (Light Blue)**
This jack is used to connect any audio devices such as Hi-fi set, CD player, tape player, AM/FM radio tuner, synthesizer, etc.
- **Line-out Jack (Lime)**
This jack is used to connect a headphone or external speakers.

Front Audio

The front audio connector allows you to connect to the second line-out and mic-in jacks that are at the front panel of your system.

BIOS Setting

Configure the onboard audio in the Chipset menu ("South Bridge" submenu) of the BIOS. Refer to chapter 3 for more information.

Driver Installation

Install the audio driver. Refer to chapter 4 for more information.

I/O Connectors

CD-in Internal Audio Connector

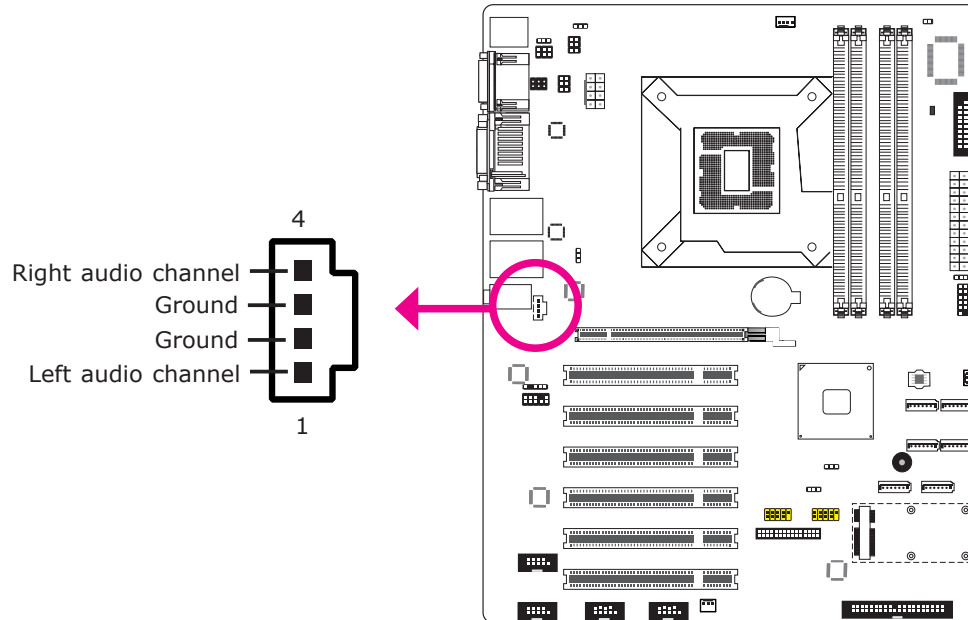

The CD-in connector is used to receive audio from a CD-ROM drive, TV tuner or MPEG card.

S/PDIF Connector

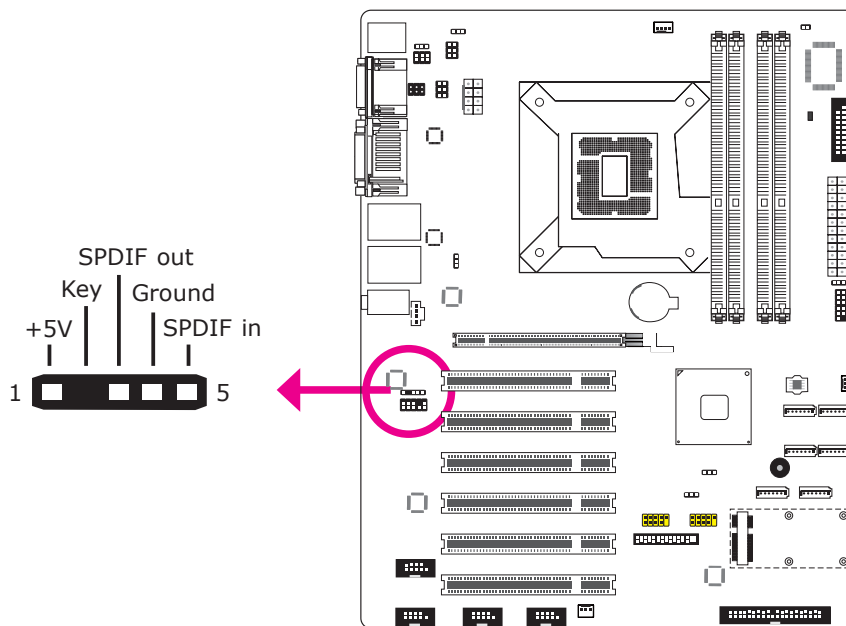

The S/PDIF connector is used to connect an external S/PDIF port. Your S/PDIF port may be mounted on a card-edge bracket. Install the card-edge bracket to an available slot at the rear of the system chassis then connect the audio cable to the S/PDIF connector. Make sure pin 1 of the audio cable is aligned with pin 1 of the S/PDIF connector.

Digital I/O Connectors

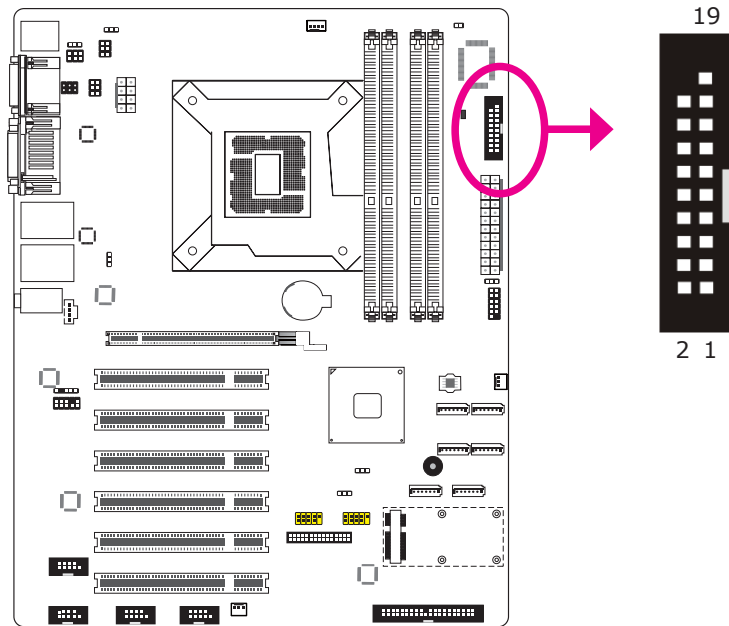

The 8-bit Digital I/O connector provides powering-on function to external devices that are connected to these connectors.

Pin	Pin Assignment	Pin	Pin Assignment
1	GND	2	+12V
3	DIO7	4	+12V
5	DIO6	6	GND
7	DIO5	8	VCC
9	DIO4	10	VCC
11	DIO3	12	GND
13	DIO2	14	V_5P0_STBY
15	DIO1	16	V_5P0_STBY
17	DIO0	18	GND
19	GND		

SATA (Serial ATA) Connectors

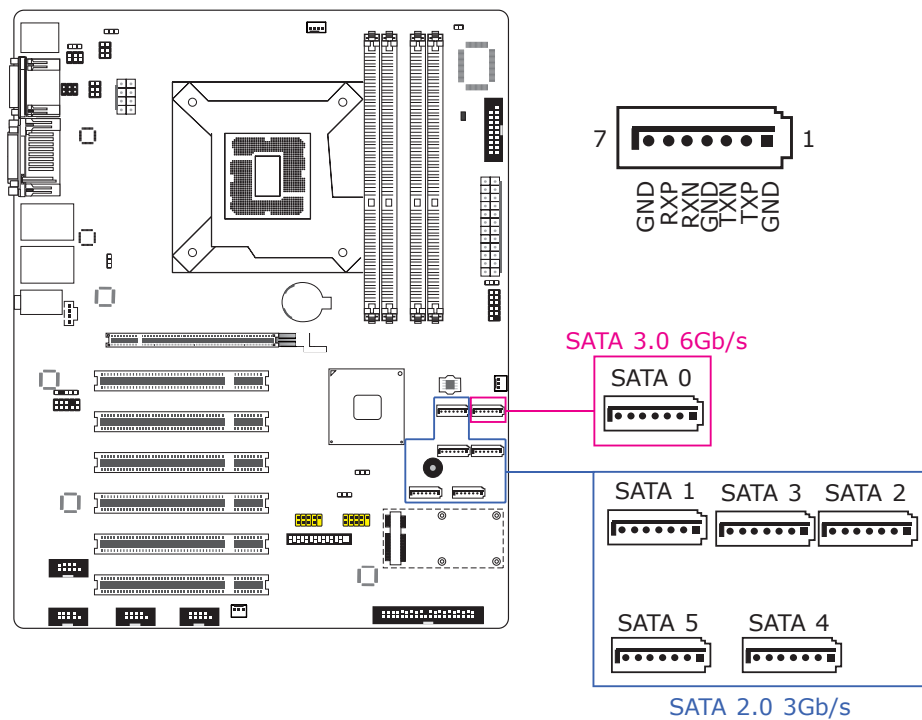

Features

- SATA 0 supports data transfer rate up to 6Gb/s
- SATA 1 to SATA 5 support data transfer rate up to 3Gb/s
- Integrated Advanced Host Controller Interface (AHCI) controller

The Serial ATA connectors are used to connect Serial ATA devices. Connect one end of the Serial ATA cable to a SATA connector and the other end to your Serial ATA device.

BIOS Setting

Configure the Serial ATA drives in the Advanced menu ("IDE Configuration" sub-menu) of the BIOS. Refer to chapter 3 for more information.

Cooling Fan Connectors

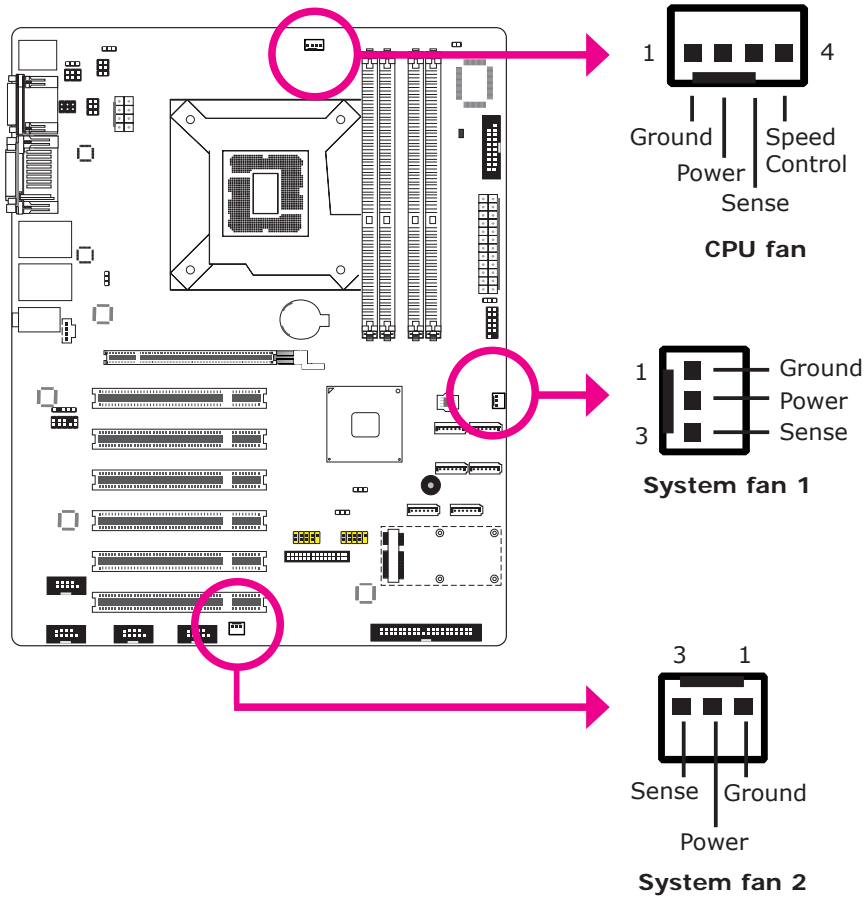

The fan connectors are used to connect cooling fans. The cooling fans will provide adequate airflow throughout the chassis to prevent overheating the CPU and system board components.

BIOS Setting

The Advanced menu ("Hardware Health Configuration" submenu) of the BIOS will display the current speed of the cooling fans. Refer to chapter 3 for more information.

Chassis Intrusion Connector

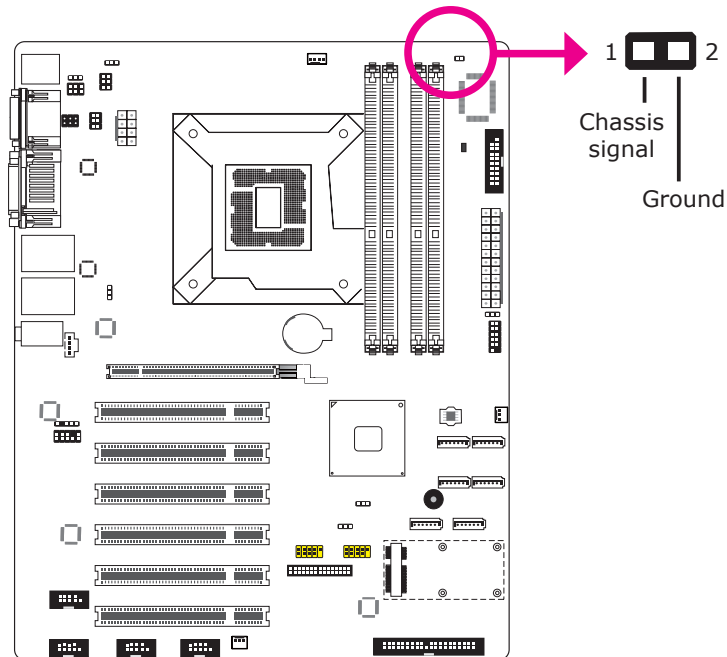

The board supports the chassis intrusion detection function. Connect the chassis intrusion sensor cable from the chassis to this connector. When the system's power is on and a chassis intrusion occurred, an alarm will sound. When the system's power is off and a chassis intrusion occurred, the alarm will sound only when the system restarts.

MyGuard Hardware Monitor

Install the "MyGuard Hardware Monitor" utility. By default, the chassis intrusion detection function is disabled. When enabled, a warning message will appear when the chassis is open. The utility can also be configured so that a beeping alarm will sound when the chassis is open. Refer to the "MyGuard Hardware Monitor" section in chapter 4 for more information.

Power Connectors

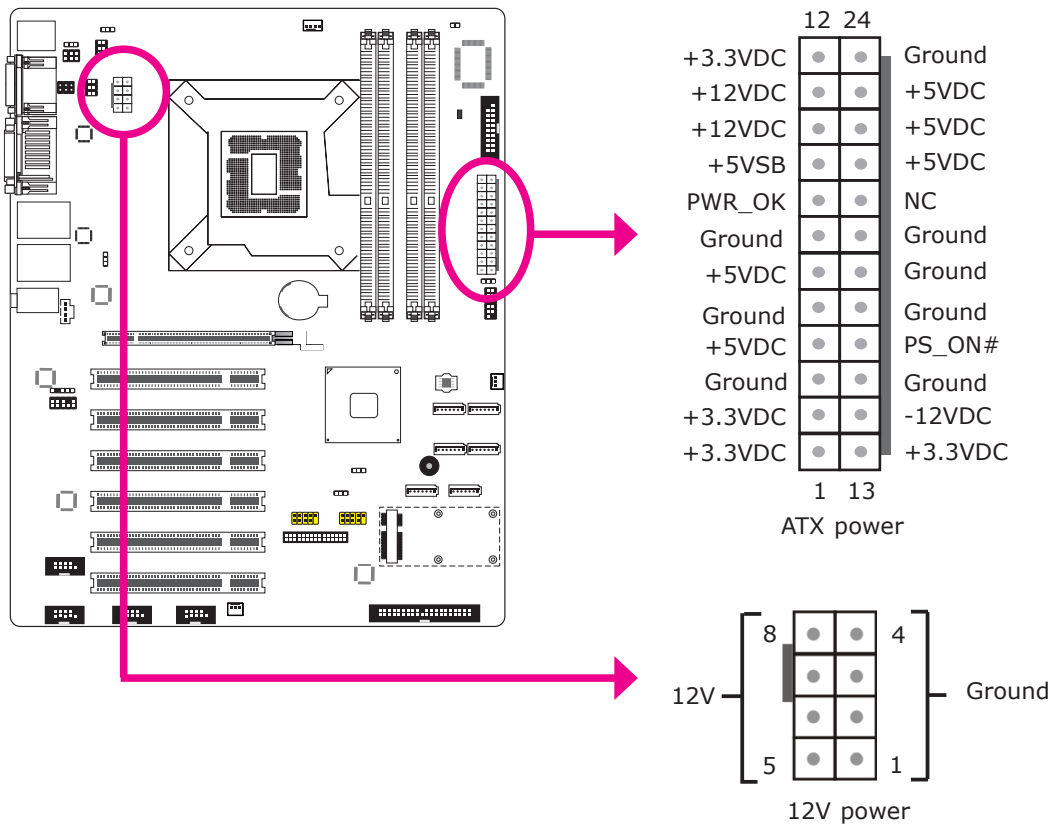

Use a power supply that complies with the ATX12V Power Supply Design Guide Version 1.1. An ATX12V power supply unit has a standard 24-pin ATX main power connector that must be inserted into the 24-pin connector. The 8-pin +12V power connector enables the delivery of more +12VDC current to the processor's Voltage Regulator Module (VRM).

The power connectors from the power supply unit are designed to fit the 24-pin and 8-pin connectors in only one orientation. Make sure to find the proper orientation before plugging the connectors.

The system board requires a minimum of 300 Watt power supply to operate. Your system configuration (CPU power, amount of memory, add-in cards, peripherals, etc.) may exceed the minimum power requirement. To ensure that adequate power is provided, we strongly recommend that you use a minimum of 400 Watt (or greater) power supply.

**Important:**

Insufficient power supplied to the system may result in instability or the add-in boards and peripherals not functioning properly. Calculating the system's approximate power usage is important to ensure that the power supply meets the system's consumption requirements.

Standby Power LED

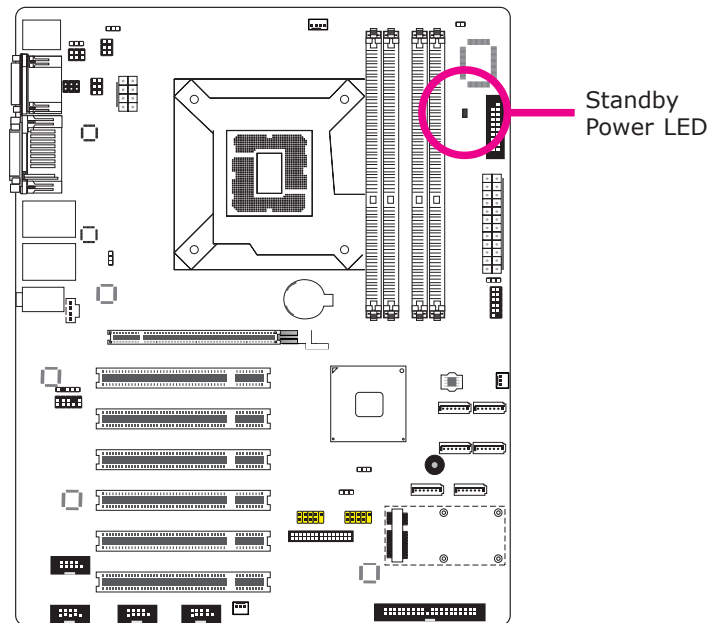

This LED will light red when the system is in the standby mode. It indicates that there is power on the system board. Power-off the PC and then unplug the power cord prior to installing any devices. Failure to do so will cause severe damage to the motherboard and components.

Front Panel Connectors

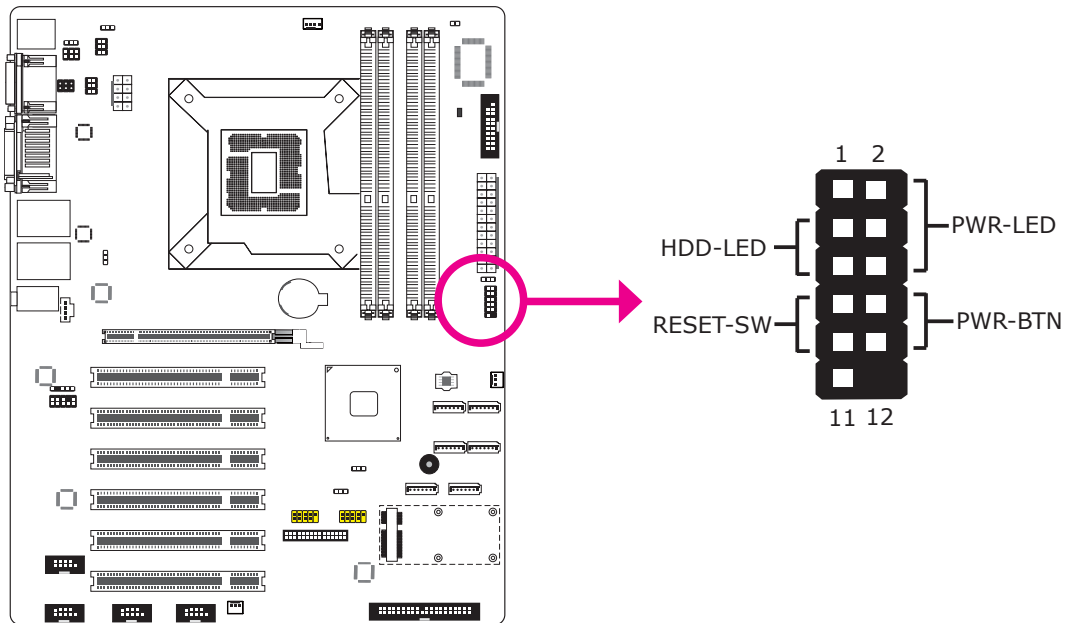

HDD-LED - HDD LED

This LED will light when the hard drive is being accessed.

RESET SW - Reset Switch

This switch allows you to reboot without having to power off the system.

PWR-BTN - Power Switch

This switch is used to power on or off the system.

PWR-LED - Power/Standby LED

When the system's power is on, this LED will light. When the system is in the S1 (POS - Power On Suspend) state, it will blink every second. When the system is in the S3 (STR - Suspend To RAM) state, it will blink every 4 seconds.

	Pin	Pin Assignment		Pin	Pin Assignment
HDD-LED	3	HDD Power	PWR-LED	2	LED Power
	5	Signal		4	LED Power
RESET SW	7	Ground		6	Signal
	9	RST Signal	PWR-BTN	8	Ground
	11	N.C.		10	Signal

Expansion Slots

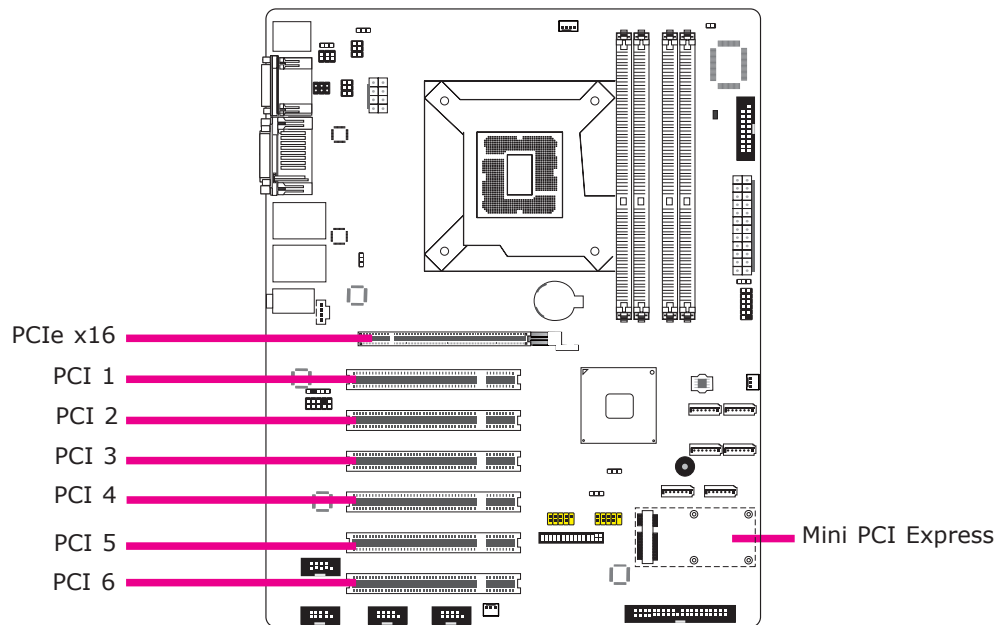

PCI Slots

The PCI slot supports expansion cards that comply with PCI specifications.

Mini PCI Express Slot

Install mini PCI Express cards such as network cards or other cards that comply to the mini PCI Express specifications into the mini PCI Express x1 slot.

IDE Connector

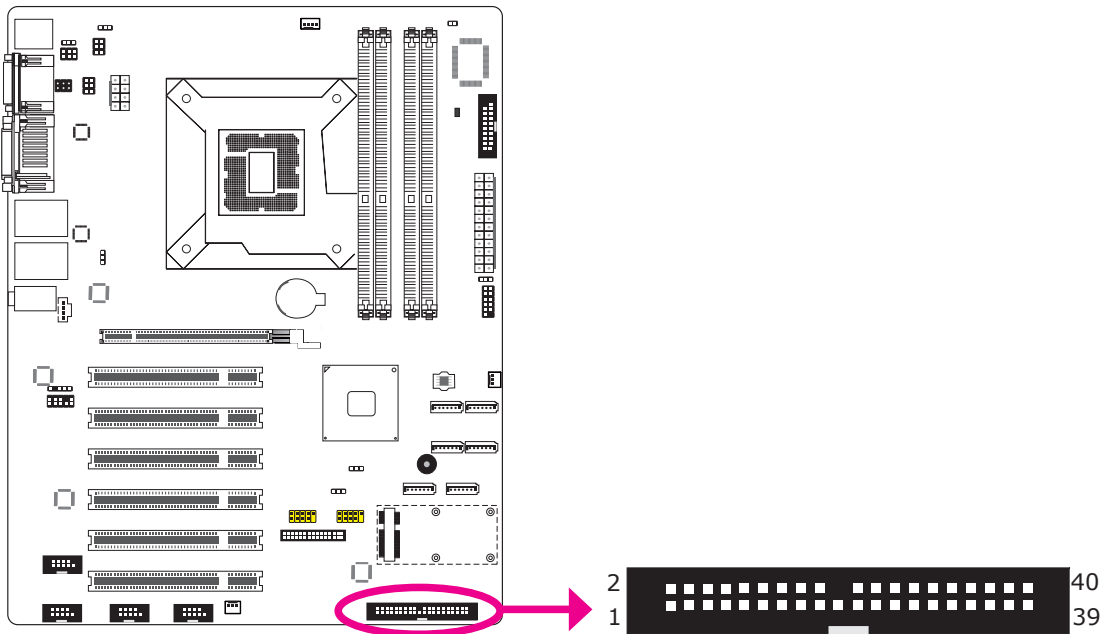

The IDE connector is used to connect hard drives. The connector on the IDE cable can be inserted into this connector only if pin 1 of the cable is aligned with pin 1 of this connector.

The IDE connector supports 2 devices, a Master and a Slave. Use an IDE ribbon cable to connect the drives to the system board. An IDE ribbon cable has 3 connectors on them, one that plugs into the IDE connector on the system board and the other 2 connects to IDE devices. The connector at the end of the cable is for the Master drive and the connector in the middle of the cable is for the Slave drive.



Note:

Refer to your disk drive user's manual for information about selecting proper drive switch settings.

Adding a Second IDE Disk Drive

When using two IDE drives, one must be set as the master and the other as the slave. Follow the instructions provided by the drive manufacturer for setting the jumpers and/or switches on the drives.

The system board supports Enhanced IDE or ATA-2, ATA/33, ATA/66, ATA/100 and ATA/133 hard drives. We recommend that you use hard drives from the same manufacturer. In a few cases, drives from two different manufacturers will not function properly when used together. The problem lies in the hard drives, not the system board.

**Important:**

If you encountered problems while using an ATAPI CD-ROM drive that is set in Master mode, please set the CD-ROM drive to Slave mode. Some ATAPI CD-ROMs may not be recognized and cannot be used if incorrectly set in Master mode.

BIOS Setting

Configure the onboard IDE in the Integrated Peripherals submenu ("OnChip IDE Device" section) of the BIOS. Refer to chapter 3 for more information.

Battery

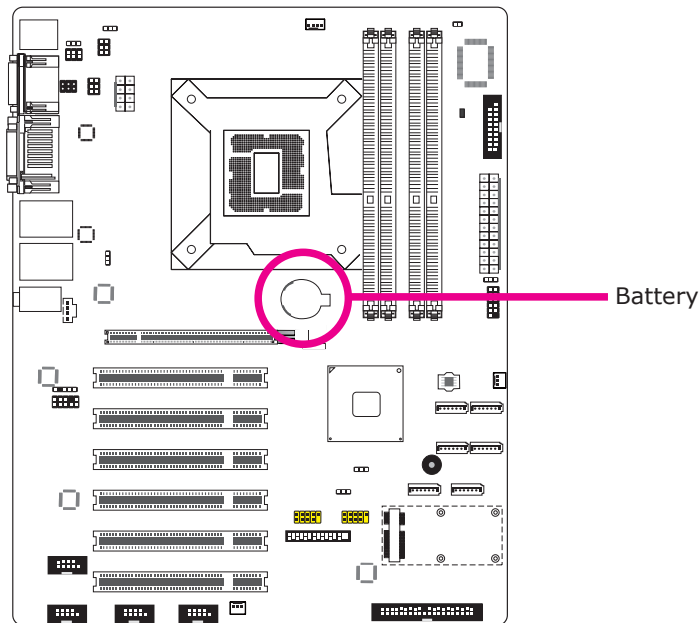

The lithium ion battery powers the real-time clock and CMOS memory. It is an auxiliary source of power when the main power is shut off.

Safety Measures

- Danger of explosion if battery incorrectly replaced.
- Replace only with the same or equivalent type recommend by the manufacturer.
- Dispose of used batteries according to local ordinance.

SDVO Connector

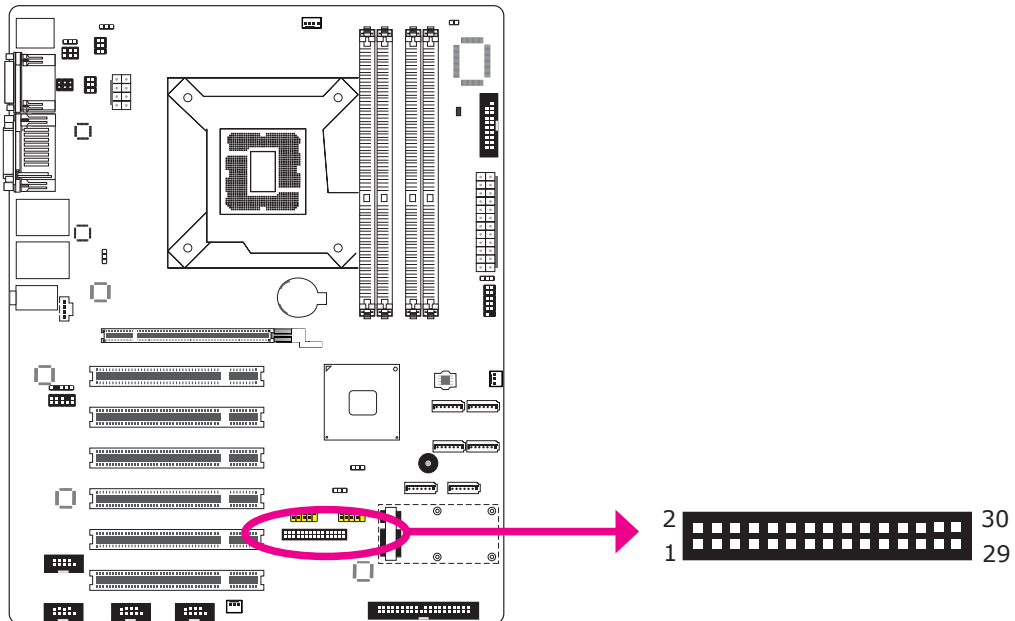

The SDVO connector is used to connect the optional SDVO-LVDS daughterboard.

Pin	Pin Assignment	Pin	Pin Assignment
1	Ground	2	DPB_AUXP
3	DPB_LANE0_P	4	DPB_AUXN
5	DPB_LANE0_N	6	SDVO_STALLP
7	Ground	8	SDVO_STALLN
9	DPB_LANE1_P	10	SDVO_INTP
11	DPB_LANE1_N	12	SDVO_INTN
13	Ground	14	PCIE_RST
15	DPB_LANE2_P	16	DPB_CTRLCLK
17	DPB_LANE2_N	18	DPB_CTRLDATA
19	Ground	20	DPB_HPD
21	DPB_LANE3_P	22	GPIO/SMCLK
23	DPB_LANE3_N	24	GPIO/SMBDATA/L_BKLTCTL
25	+3V3	26	+3V3
27	+5V	28	+5V
29	+12V	30	+12V

SDVO-LVDS Daughterboard (optional)

Features

- Chrontel CH7308B
- Supports 18/24-bit 1600x1200 LVDS panel (default 1024x768)
- 1 LVDS LCD panel connector
- 1 LCD/Inverter power connector
- SDVO interface
- Supports dimming control via hot keys

Dimensions

- 45mm (1.77") x 38mm (1.49")

Jumper Settings

Panel Power Select

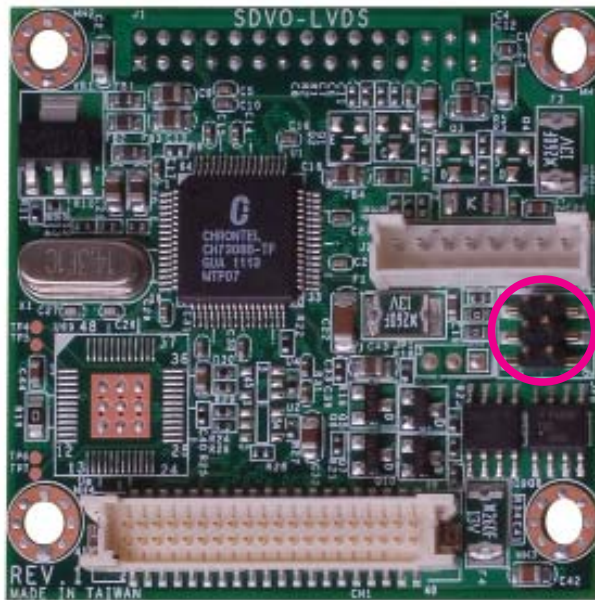

1 2
 3 4
 5 6
 1-2 On: +12V

1 2
 3 4
 5 6
 3-4 On: +5V

1 2
 3 4
 5 6
 5-6 On: +3.3V
 (default)

JP8 is used to select the power supplied to the LCD panel.



Important:

Before powering-on the system, make sure JP8's setting matches the LCD panel's specification. Selecting the incorrect voltage will seriously damage the LCD panel.

I/O Connectors

LVDS LCD Panel Connector

LCD/Inverter Power Connector

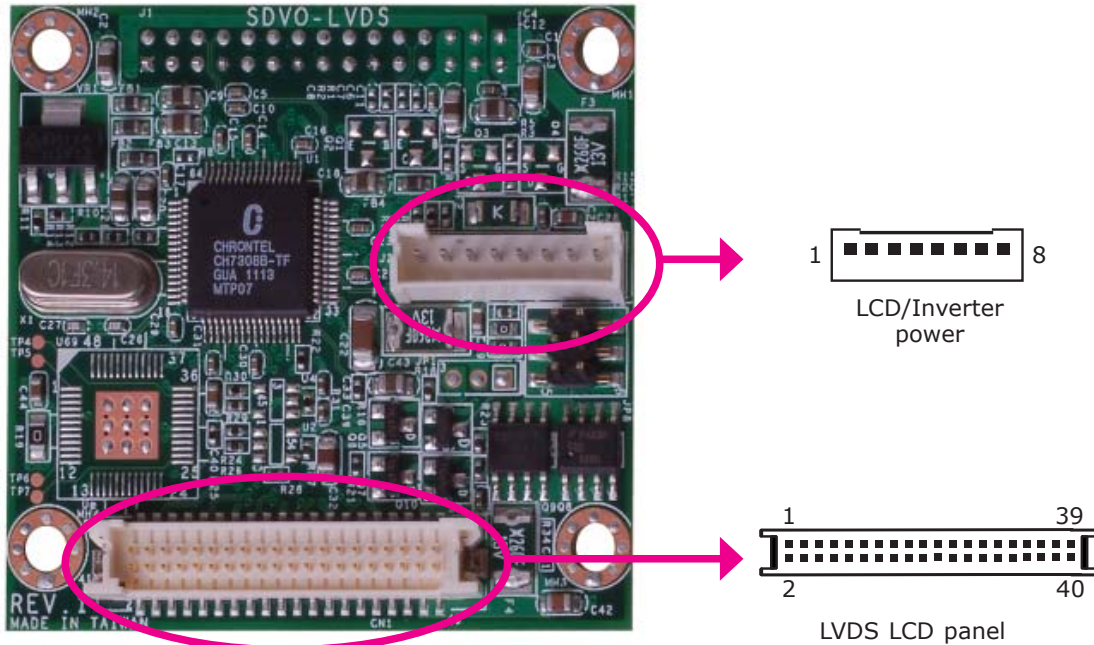

The system board allows you to connect a LCD Display Panel by means of the LVDS LCD panel connector and the LCD/Inverter power connector. These connectors transmit video signals and power from the system board to the LCD Display Panel.

LVDS LCD Panel Connector

Pins	Function	Pins	Function
1	GND	2	GND
3	N. C.	4	N. C.
5	N. C.	6	N. C.
7	GND	8	GND
9	LVDS_Out2+	10	LVDS_Out6+
11	LVDS_Out2-	12	LVDS_Out6-
13	GND	14	GND
15	LVDS_Out1+	16	LVDS_Out5+
17	LVDS_Out1-	18	LVDS_Out5-
19	GND	20	GND
21	LVDS_Out0+	22	LVDS_Out4+
23	LVDS_Out0-	24	LVDS_Out4-
25	GND	26	GND
27	LVDS_CLK1+	28	LVDS_CLK2+
29	LVDS_CLK1-	30	LVDS_CLK2-
31	GND	32	GND
33	LVDS_DDCCLK	34	N. C.
35	LVDS_DDCDAA	36	N. C.
37	Panel Power	38	Panel Power
39	Panel Power	40	Panel Power

LCD/Inverter Power Connector

Pins	Function
1	GND
2	GND
3	Panel Inverter Brightness Voltage Control
4	Panel Power
5	+3.3V
6	Panel Backlight On/Off Control
7	+12V
8	+12V

Installing the SDVO-LVDS Daughterboard onto the Motherboard (optional)

**Important:**

The motherboard used in this section is for reference purpose only and may not resemble your motherboard. These illustrations are mainly to guide you on how to install SDVO-LVDS onto the motherboard of your choice.

1. The photo below shows the location of the mounting hole on the motherboard.

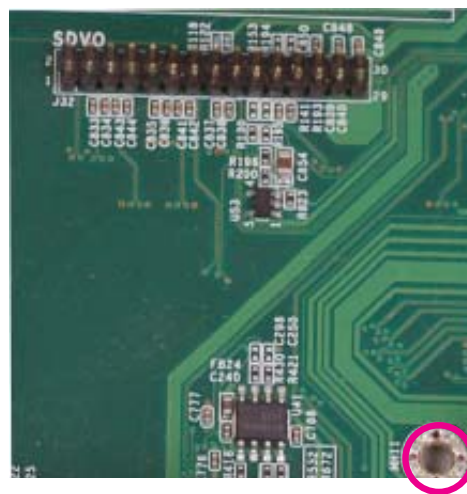

Mounting hole

2. Insert the provided mounting screws into the mounting hole - from the bottom through the top of the motherboard.



Mounting screws



3. While supporting the mounting screw at the bottom, from the top side of the board, fasten a bolt into the screw.

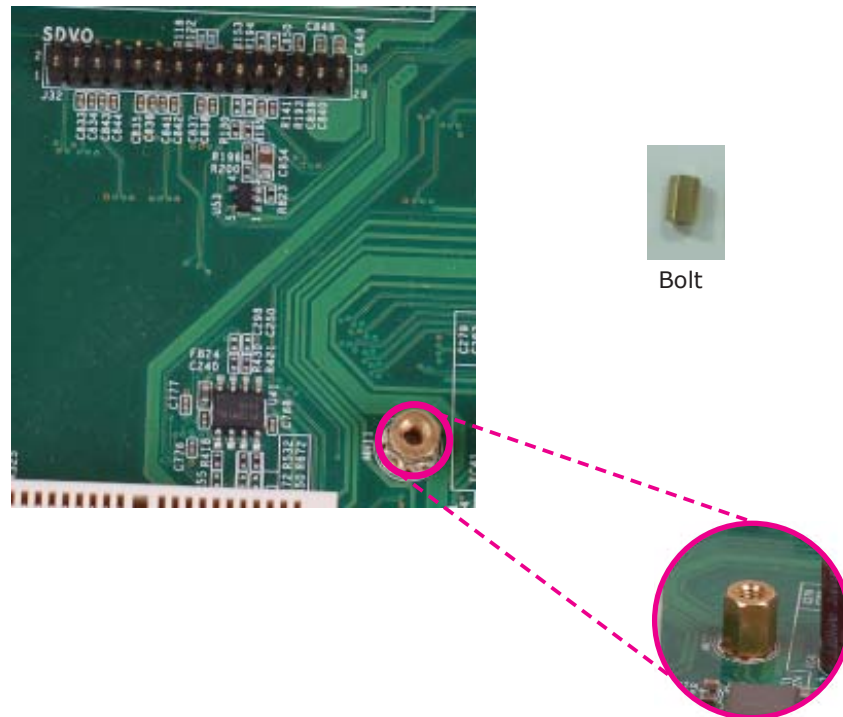

4. The SDVO connector is located at the bottom of the daughterboard. Grasping SDVO-LVDS by its edges, position it on top of the motherboard's SDVO connector with its mounting holes aligned with the bolts on the motherboard. This will also align the SDVO connector of the two boards to each other.



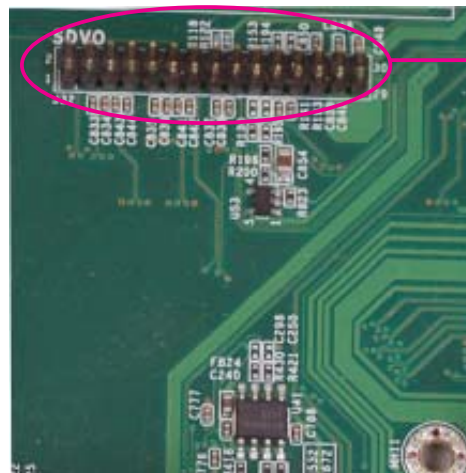

SDVO connector on the motherboard

5. Press SDVO-LVDS down firmly until it is completely seated on the SDVO connector of the motherboard.

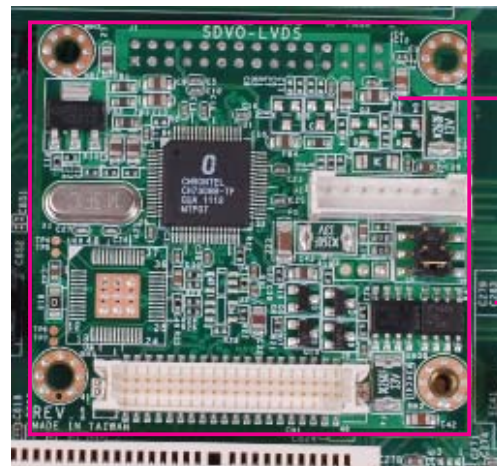

SDVO-LVDS

Motherboard

6. Use the provided mounting screws to secure SDVO-LVDS to the motherboard.



Mounting screw

Chapter 3 - BIOS Setup

Overview

The BIOS is a program that takes care of the basic level of communication between the CPU and peripherals. It contains codes for various advanced features found in this system board. The BIOS allows you to configure the system and save the configuration in a battery-backed CMOS so that the data retains even when the power is off. In general, the information stored in the CMOS RAM of the EEPROM will stay unchanged unless a configuration change has been made such as a hard drive replaced or a device added.

It is possible that the CMOS battery will fail causing CMOS data loss. If this happens, you need to install a new CMOS battery and reconfigure the BIOS settings.



Note:

The BIOS is constantly updated to improve the performance of the system board; therefore the BIOS screens in this chapter may not appear the same as the actual one. These screens are for reference purpose only.

Default Configuration

Most of the configuration settings are either predefined according to the Load Optimal Defaults settings which are stored in the BIOS or are automatically detected and configured without requiring any actions. There are a few settings that you may need to change depending on your system configuration.

Entering the BIOS Setup Utility

The BIOS Setup Utility can only be operated from the keyboard and all commands are keyboard commands. The commands are available at the right side of each setup screen.

The BIOS Setup Utility does not require an operating system to run. After you power up the system, the BIOS message appears on the screen and the memory count begins. After the memory test, the message "Press DEL to run setup" will appear on the screen. If the message disappears before you respond, restart the system or press the "Reset" button. You may also restart the system by pressing the <Ctrl> <Alt> and keys simultaneously.

Legends

Keys	Function
Right and Left arrows	Moves the highlight left or right to select a menu.
Up and Down arrows	Moves the highlight up or down between submenus or fields.
<Esc>	Exits to the BIOS Setup Utility.
+ (plus key)	Scrolls forward through the values or options of the highlighted field.
- (minus key)	Scrolls backward through the values or options of the highlighted field.
<F1>	Displays General Help.
<F2>	Previous Values.
<F3>	Optimized Defaults.
<F4>	Saves and exits the Setup program.
<Enter>	Press <Enter> to enter the highlighted submenu.

Scroll Bar

When a scroll bar appears to the right of the setup screen, it indicates that there are more available fields not shown on the screen. Use the up and down arrow keys to scroll through all the available fields.

Submenu

When "►" appears on the left of a particular field, it indicates that a submenu which contains additional options are available for that field. To display the submenu, move the highlight to that field and press <Enter>.

AMI BIOS Setup Utility

Main

The Main menu is the first screen that you will see when you enter the BIOS Setup Utility.

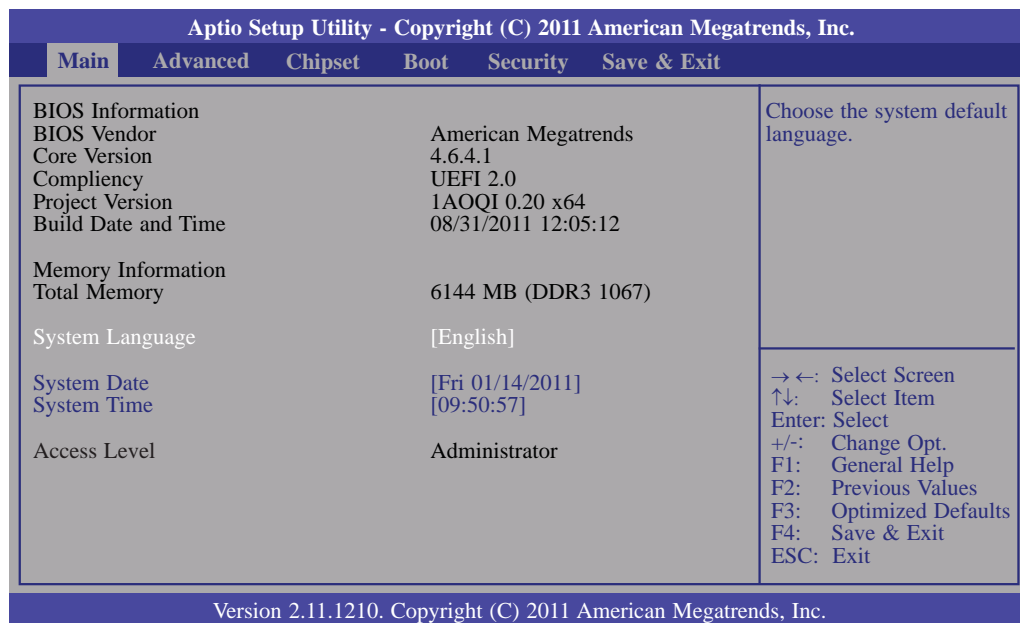

System Language

Choose the system default language.

System Date

The date format is <day>, <month>, <date>, <year>. Day displays a day, from Sunday to Saturday. Month displays the month, from January to December. Date displays the date, from 1 to 31. Year displays the year, from 1980 to 2099.

System Time

The time format is <hour>, <minute>, <second>. The time is based on the 24-hour military-time clock. For example, 1 p.m. is 13:00:00. Hour displays hours from 00 to 23. Minute displays minutes from 00 to 59. Second displays seconds from 00 to 59.

Advanced

The Advanced menu allows you to configure your system for basic operation. Some entries are defaults required by the system board, while others, if enabled, will improve the performance of your system or let you set some features according to your preference.



Important:

Setting incorrect field values may cause the system to malfunction.

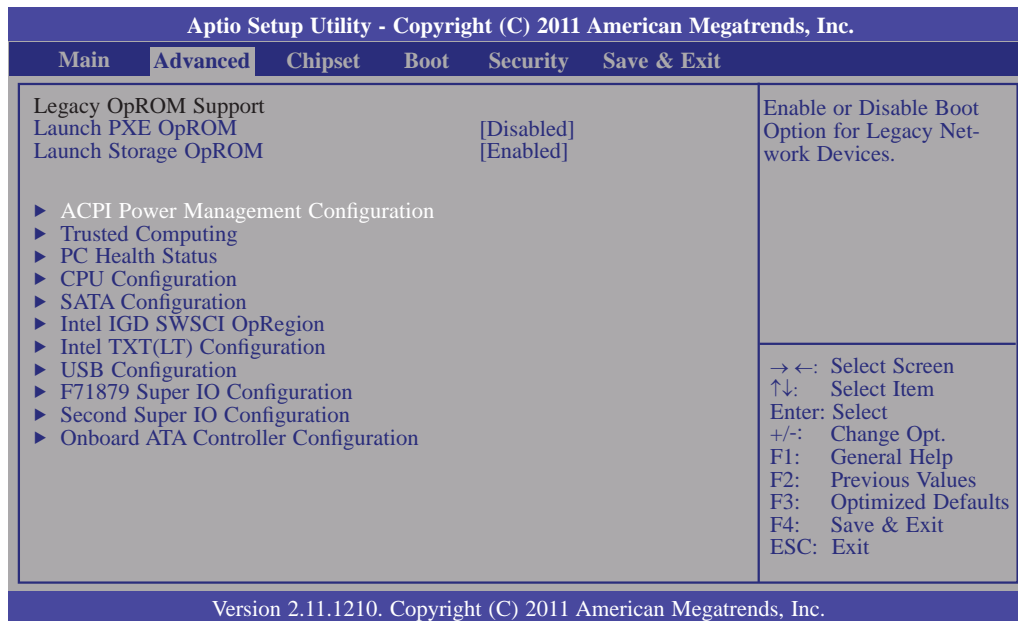

Launch PXE OpROM

Enables or disables the boot option for legacy network devices.

Launch Storage OpROM

Enables or disables the boot option for legacy mass storage devices with option ROM.

ACPI Power Management Configuration

This section is used to configure the ACPI Power Management.

Aptio Setup Utility - Copyright (C) 2011 American Megatrends, Inc.		
Advanced		
ACPI Power Management Configuration		Select the highest ACPI sleep state the system will enter, when the SUSPEND button is pressed.
ACPI Sleep State	[S3 (Suspend to RAM)]	
Resume by PME	[Disabled]	
Resume by Ring	[Disabled]	
Resume by RTC Alarm	[Disabled]	
		→ ←: Select Screen ↑↓: Select Item Enter: Select +/-: Change Opt. F1: General Help F2: Previous Values F3: Optimized Defaults F4: Save & Exit ESC: Exit
Version 2.11.1210. Copyright (C) 2011 American Megatrends, Inc.		

ACPI Sleep State

Selects the highest ACPI sleep state the system will enter when the Suspend button is pressed.

- S1(POS) Enables the Power On Suspend function.
 S3(STR) Enables the Suspend to RAM function.

Resume by PME

Enable this field to use the PME signal to wake up the system.

Resume by Ring

Set this field to Enabled to use the modem ring-on function. This will allow your system to power-on to respond to calls coming through an external or internal modem.

Resume by RTC Alarm

When Enabled, the system uses the RTC to generate a wakeup event.

Trusted Computing (optional)

This section configures settings relevant to Trusted Computing innovations.

Aptio Setup Utility - Copyright (C) 2011 American Megatrends, Inc.	
Advanced	
TPM Configuration TPM Support [Disabled]	Enables or Disables TPM support. O.S. will not show TPM. Reset of platform is required.
Current TPM Status Information NO TPM Hardware	
	→ ←: Select Screen ↑↓: Select Item Enter: Select +/-: Change Opt. F1: General Help F2: Previous Values F3: Optimized Defaults F4: Save & Exit ESC: Exit
Version 2.11.1210. Copyright (C) 2011 American Megatrends, Inc.	

TPM Support

Enables or Disables TPM. O.S. will not show TPM. Resetting the platform is required.

PC Health Status

This section displays the SIO hardware health monitor.

Aptio Setup Utility - Copyright (C) 2011 American Megatrends, Inc.		
Advanced		
▶ Smart Fan Function		Smart Fan Function
Case Open	[Disabled]	
System Hardware Monitor		
CPU Temperature	: +38 C	
System Temperature	: +24 C	
CPU FAN Speed	: 2803 RPM	
System FAN1 Speed	: N/A	
System FAN2 Speed	: N/A	
VCore	: +1.192 V	
+5.0V	: +5.112 V	
+12V	: +12.056V	
VDIMM	: +1.536 V	
+3.3V	: +3.376 V	
VSBS5V	: +5.032 V	
VSBS3V	: +3.376 V	
VBAT	: +3.312 V	
		→ ←: Select Screen ↑ ↓: Select Item Enter: Select +/-: Change Opt. F1: General Help F2: Previous Values F3: Optimized Defaults F4: Save & Exit ESC: Exit
Version 2.11.1210. Copyright (C) 2011 American Megatrends, Inc.		

Smart Fan Function

Aptio Setup Utility - Copyright (C) 2011 American Megatrends, Inc.		
Advanced		
Smart Fan Function		Enable CPU SmartFan
CPU Smart Fan Control	[Automatic]	
Boundary 1	60	
Boundary 2	50	
Boundary 3	40	
Boundary 4	30	
Speed Count 1	100	
Speed Count 2	75	
Speed Count 3	50	
Speed Count 4	40	
Speed Count 5	30	
		→ ←: Select Screen ↑ ↓: Select Item Enter: Select +/-: Change Opt. F1: General Help F2: Previous Values F3: Optimized Defaults F4: Save & Exit ESC: Exit
Version 2.11.1210. Copyright (C) 2011 American Megatrends, Inc.		

CPU Smart Fan Control

When this feature is set to Automatic, the CPU's fan speed will rotate according to the CPU's temperature. The higher the temperature, the faster the speed of rotation.

Boundary 1 to Boundary 4

The range is from 0-127.

Speed Count 1 to Speed Count 5

The range is from 1-100.

Case Open

Set this field to Enabled to allow the system to alert you of a chassis intrusion event.

CPU Temperature to VBAT

These fields will show the temperature, fan speed and output voltage of the monitored devices or components.

CPU Configuration

This section is used to configure the CPU. It will also display the detected CPU information.

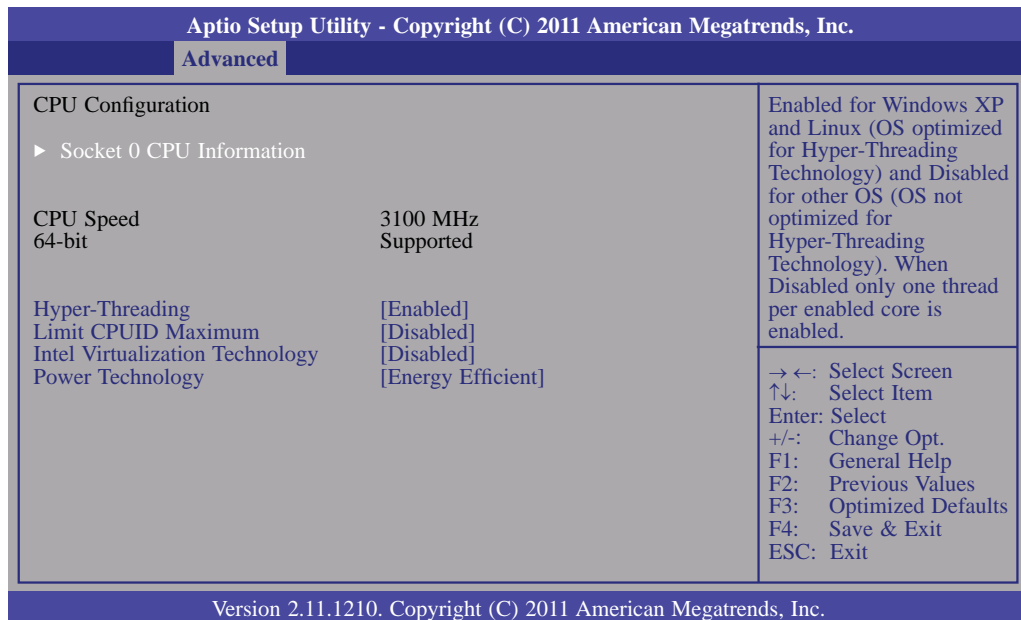

Limit CPUID Maximum

The CPUID instruction of some newer CPUs will return a value greater than 3. The default is Disabled because this problem does not exist in the Windows series operating systems. If you are using an operating system other than Windows, this problem may occur. To avoid this problem, enable this field to limit the return value to 3 or less than 3.

Intel Virtualization Technology

When this field is set to Enabled, the VMM can utilize the additional hardware capabilities provided by Vanderpool Technology.

Power Technology

Enables the power management features.

SATA Configuration

This section is used to configure SATA functions.

Aptio Setup Utility - Copyright (C) 2011 American Megatrends, Inc.		
Advanced		
SATA Configuration		(1) IDE Mode. (2) AHCI Mode.
SATA Mode	[IDE Mode]	
Serial-ATA Controller 0	[Compatible]	
Serial-ATA Controller 1	[Enhanced]	
SATA Port 0	Not Present	
SATA Port 1	Not Present	
SATA Port 2	Not Present	
SATA Port 3	Not Present	
SATA Port 4	Not Present	
SATA Port 5	Not Present	
		→ ←: Select Screen ↑↓: Select Item Enter: Select +/-: Change Opt. F1: General Help F2: Previous Values F3: Optimized Defaults F4: Save & Exit ESC: Exit
Version 2.11.1210. Copyright (C) 2011 American Megatrends, Inc.		

SATA Mode

IDE Mode

This option configures the Serial ATA drives as Parallel ATA storage devices.

AHCI Mode

This option allows the Serial ATA devices to use AHCI (Advanced Host Controller Interface).

Serial-ATA Controller 0 and Serial-ATA Controller 1

These fields are used to enable or disable the Serial ATA channels.

If AHCI is selected in the SATA Mode field, it will display the following information:

Aptio Setup Utility - Copyright (C) 2011 American Megatrends, Inc.		
Advanced		
SATA Configuration		(1) IDE Mode. (2) AHCI Mode. (3) RAID Mode.
SATA Mode	[IDE Mode]	
SATA Port 0 Hot Plug	Not Present [Disabled]	
SATA Port 1 Hot Plug	Not Present [Disabled]	
SATA Port 2 Hot Plug	Not Present [Disabled]	
SATA Port 3 Hot Plug	Not Present [Disabled]	→ ←: Select Screen ↑↓: Select Item Enter: Select +/-: Change Opt. F1: General Help F2: Previous Values F3: Optimized Defaults F4: Save & Exit ESC: Exit
SATA Port 4 Hot Plug	Not Present [Disabled]	
SATA Port 5 Hot Plug	Not Present [Disabled]	
Version 2.11.1210. Copyright (C) 2011 American Megatrends, Inc.		

Serial ATA Port 0 to Serial ATA Port 5

These fields are used to configure the connected SATA devices.

Intel IGD SWSCI OpRegion

This section is used to configure the Intel graphics display.

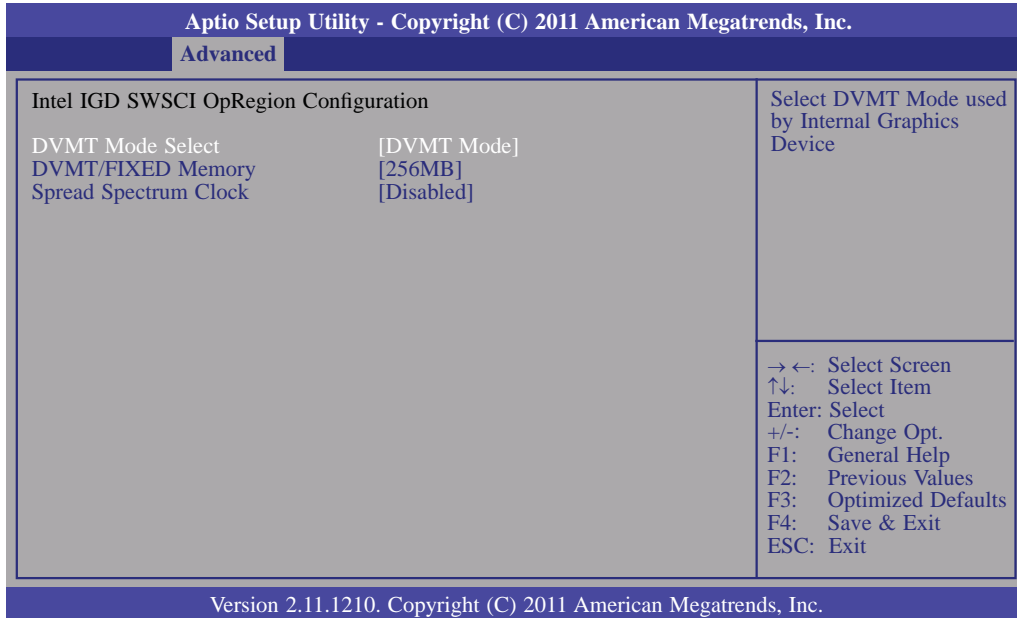

DVMT Mode Select

This field shows the current DVMT mode.

DVMT/FIXED Memory

This field is used to select the graphics memory size used by DVMT/Fixed mode.

Spread Spectrum Clock

Leave this field in its default setting. Do not alter this setting unless advised by an engineer or technician.

Intel TXT (LT) Configuration

This section is used to configure the Intel Trusted Execution technology.

Aptio Setup Utility - Copyright (C) 2011 American Megatrends, Inc.	
Advanced	
Intel Trusted Execution Technology Configuration	
Intel TXT support only can be enabled/disabled if SMX is enabled. VT and VT-d support must also be enabled prior to TXT.	
Secure Mode Extension (SMX)	[Disabled]
Intel TXT(LT) Support	[Disabled]
→ ←: Select Screen ↑ ↓: Select Item Enter: Select +/-: Change Opt. F1: General Help F2: Previous Values F3: Optimized Defaults F4: Save & Exit ESC: Exit	
Version 2.11.1210. Copyright (C) 2011 American Megatrends, Inc.	

Intel TXT(LT) Support

The options are Enabled and Disabled.

USB Configuration

This section is used to configure USB.

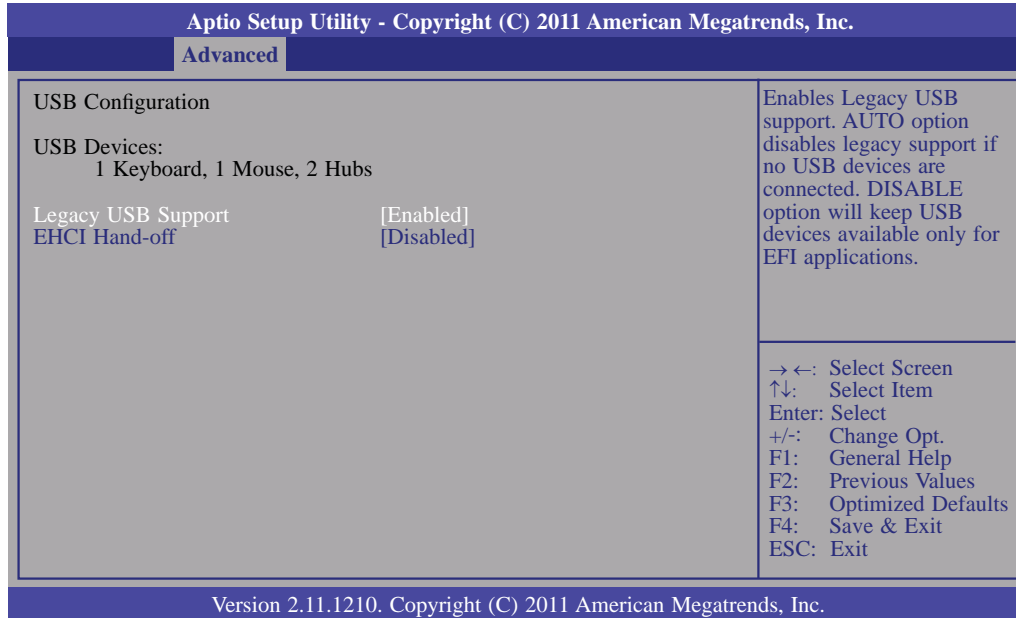

Legacy USB Support

Enabled

Enables legacy USB.

Auto

Disables support for legacy when no USB devices are connected.

Disabled

Keeps USB devices available only for EFI applications.

EHCI Hand-off

This is a workaround for OSES that does not support EHCI hand-off. The EHCI ownership change should be claimed by the EHCI driver.

F71879 Super IO Configuration

This section is used to configure the I/O functions supported by the onboard Super I/O chip.

Aptio Setup Utility - Copyright (C) 2011 American Megatrends, Inc.		
Advanced		
F71879 Super IO Configuration		Restore AC Power Loss help.
Super IO Chip	Fintek F71879	
Restore AC Power Loss	[Power Off]	
WatchDog Timer	[Disabled]	
Super IO WatchDog Timer	10	
▶ Serial Port 1 Configuration		
▶ Serial Port 2 Configuration		
		→ ←: Select Screen ↑↓: Select Item Enter: Select +/-: Change Opt. F1: General Help F2: Previous Values F3: Optimized Defaults F4: Save & Exit ESC: Exit
Version 2.11.1210. Copyright (C) 2011 American Megatrends, Inc.		

Restore AC Power Loss

Off

When power returns after an AC power failure, the system's power is off. You must press the Power button to power-on the system.

On

When power returns after an AC power failure, the system will automatically power-on.

Last State

When power returns after an AC power failure, the system will return to the state where you left off before power failure occurs. If the system's power is off when AC power failure occurs, it will remain off when power returns. If the system's power is on when AC power failure occurs, the system will power-on when power returns.

WatchDog Timer

This field is used to select the time interval of the Watchdog timer. If the system hangs or fails to function, it will reset at the set time interval so that your system will continue to operate.

Serial Port 1 Configuration to Serial Port 2 Configuration

Aptio Setup Utility - Copyright (C) 2011 American Megatrends, Inc.		
Advanced		
Serial Port 1 Configuration		Enable or Disable Serial Port (COM)
Serial Port Device Settings	[Enabled] IO=3F8h; IRQ=4;	
Change Settings	[Auto]	
		→ ←: Select Screen ↑ ↓: Select Item Enter: Select +/-: Change Opt. F1: General Help F2: Previous Values F3: Optimized Defaults F4: Save & Exit ESC: Exit
Version 2.11.1210. Copyright (C) 2011 American Megatrends, Inc.		

Aptio Setup Utility - Copyright (C) 2011 American Megatrends, Inc.		
Advanced		
Serial Port 2 Configuration		Enable or Disable Serial Port (COM)
Serial Port Device Settings	[Enabled] IO=2F8h; IRQ=3;	
Change Settings	[Auto]	
		→ ←: Select Screen ↑ ↓: Select Item Enter: Select +/-: Change Opt. F1: General Help F2: Previous Values F3: Optimized Defaults F4: Save & Exit ESC: Exit
Version 2.11.1210. Copyright (C) 2011 American Megatrends, Inc.		

Serial Port

Enables or disables the serial port.

Change Settings

Selects the IO/IRQ setting of the I/O device.

Onboard ATA Controller Configuration

This section configures settings relevant to the onboard ATA Controller Configuration.

Aptio Setup Utility - Copyright (C) 2011 American Megatrends, Inc.		
Advanced		
PATA Primary Master	Maxtor 6L120P0 (123GB)	
PATA Primary Slave	Not Present	
ATA Controller	[IDE Mode]	
		→ ←: Select Screen ↑↓: Select Item Enter: Select +/-: Change Opt. F1: General Help F2: Previous Values F3: Optimized Defaults F4: Save & Exit ESC: Exit
Version 2.11.1210. Copyright (C) 2011 American Megatrends, Inc.		

Chipset

Configures relevant chipset functions.

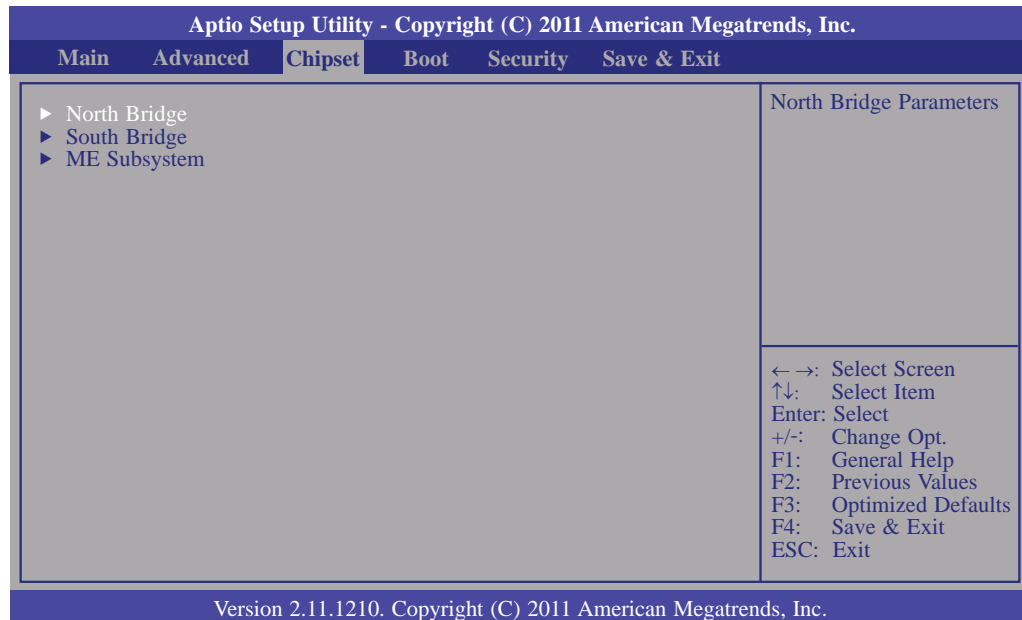

North Bridge

Aptio Setup Utility - Copyright (C) 2011 American Megatrends, Inc.		
Chipset		
Memory Information		VT-d Enable/Disable
Total Memory	6144 MB (DDR3 1067)	
Memory Slot0	2048 MB (DDR3 1067)	
Memory Slot1	2048 MB (DDR3 1067)	
Memory Slot2	1024 MB (DDR3 1067)	
Memory Slot3	1024 MB (DDR3 1067)	
VT-d	[Disabled]	
Initiate Graphic Adapter	[PEG/IGD]	→ ←: Select Screen
IGD Memory	[64M]	↑↓: Select Item
IGD Multi-Monitor	[Disabled]	Enter: Select
		+/-: Change Opt.
		F1: General Help
		F2: Previous Values
		F3: Optimized Defaults
		F4: Save & Exit
		ESC: Exit
PCI Express Port	[Auto]	
Version 2.11.1210. Copyright (C) 2011 American Megatrends, Inc.		

VT-d

The options are Enabled and Disabled.

Initiate Graphic Adapter

Selects the graphics controller to use as the primary boot device.

When this field is set to "IGD Function", you can use the display output from both the integrated graphics and PCIe x16 graphics card to support total of 4 multiple displays (Extended Mode).

IGD Memory

Selects the internal graphics device's shared memory size.

IGD Multi-Monitor

Selects Enabled to support multiple monitors.

PCI Express Port

This field is used to enable or disable the PCI Express Port function.

South Bridge

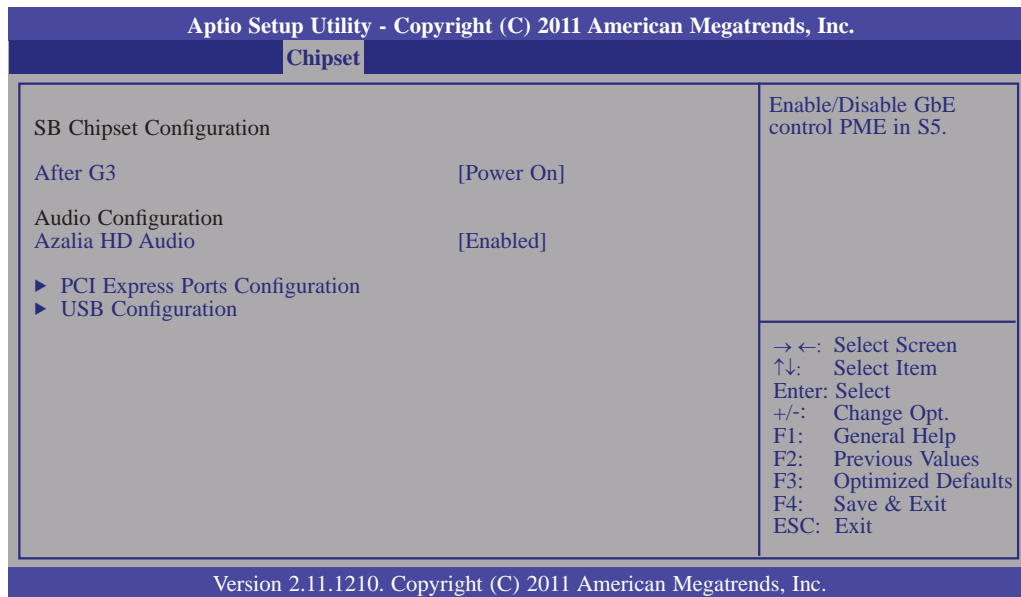

GbE Controller

Enables or disables the Gigabit LAN controller.

Wake on Lan from S5

When enabled, it allows the system to wake up from S5 via the network LAN.

After G3

Power Off / WOL

Power-on the system via WOL after G3.

Power On

Power-on the system after G3.

Azalia HD Audio

Enables or disables the Azalia HD audio.

PCI Express Ports Configuration

Aptio Setup Utility - Copyright (C) 2011 American Megatrends, Inc.	
Chipset	
PCI Express Ports Configuration Onboard ATA Controller [Enabled] Mini PCIe [Auto] Onboard LAN1 [Enabled] Onboard LAN2 [Enabled]	Enable/Disable the PCI Express Ports in the Chipset. → ←: Select Screen ↑↓: Select Item Enter: Select +/-: Change Opt. F1: General Help F2: Previous Values F3: Optimized Defaults F4: Save & Exit ESC: Exit
Version 2.11.1210. Copyright (C) 2011 American Megatrends, Inc.	

Onboard LAN1 and Onboard LAN2

Enables or disables the onboard LAN.

Onboard ATA Controller

Enables or disables the onboard ATA controller.

Mini PCIe

Enables or disables the Mini PCIe.

USB Configuration

Aptio Setup Utility - Copyright (C) 2011 American Megatrends, Inc.		
Chipset		
USB Configuration		Enable/Disable All USB Devices
All USB Devices	[Enabled]	
EHCI Controller 1	[Enabled]	
EHCI Controller 2	[Enabled]	
USB Port 0	[Enabled]	
USB Port 1	[Enabled]	
USB Port 2	[Enabled]	
USB Port 3	[Enabled]	
USB Port 4	[Enabled]	
USB Port 5	[Enabled]	
USB Port 8	[Enabled]	
USB Port 9	[Enabled]	
USB Port 10	[Enabled]	
USB Port 11	[Enabled]	
USB Port 12	[Enabled]	
		→ ←: Select Screen ↑ ↓: Select Item Enter: Select +/-: Change Opt. F1: General Help F2: Previous Values F3: Optimized Defaults F4: Save & Exit ESC: Exit
Version 2.11.1210. Copyright (C) 2011 American Megatrends, Inc.		

All USB Devices

Enables or disables all USB devices.

EHCI Controller 1 and EHCI Controller 2

These fields are used to enable or disable Enhanced Host Controller Interface (USB 2.0).

USB Port 0 to USB Port 12

Enables or disables the selected USB port.

ME Subsystem

Aptio Setup Utility - Copyright (C) 2011 American Megatrends, Inc.		
Chipset		
Intel ME Subsystem Configuration		ME Subsystem Help
ME Version	7.0.4.1197	
ME Subsystem	[Enabled]	
Execute MEBx	[Enabled]	
		→ ←: Select Screen ↑↓: Select Item Enter: Select +/-: Change Opt. F1: General Help F2: Previous Values F3: Optimized Defaults F4: Save & Exit ESC: Exit
Version 2.11.1210. Copyright (C) 2011 American Megatrends, Inc.		

ME Subsystem

The options are Enabled and Disabled.

Execute MEBx

Enables or disables Management Engine BIOS.

Boot

Aptio Setup Utility - Copyright (C) 2011 American Megatrends, Inc.					
Main	Advanced	Chipset	Boot	Security	Save & Exit
Boot Configuration				Number of seconds to wait for setup activation key. 65535(0xFFFF) means indefinite waiting.	
Setup Prompt Timeout		1			
Bootup NumLock State		[On]			
Quiet Boot		[Disabled]			
CSM16 Module Version		07.64			
Boot Option Priorities					
				← →: Select Screen ↑↓: Select Item Enter: Select +/-: Change Opt. F1: General Help F2: Previous Values F3: Optimized Defaults F4: Save & Exit ESC: Exit	
Version 2.11.1210. Copyright (C) 2011 American Megatrends, Inc.					

Setup Prompt Timeout

Selects the number of seconds to wait for the setup activation key. 65535(0xFFFF) denotes indefinite waiting.

Bootup NumLock State

This allows you to determine the default state of the numeric keypad. By default, the system boots up with NumLock on wherein the function of the numeric keypad is the number keys. When set to Off, the function of the numeric keypad is the arrow keys.

Quiet Boot

Enables or disables the quiet boot function.

Boot Option Priorities

Selects the boot sequence of the device.

Security

Aptio Setup Utility - Copyright (C) 2011 American Megatrends, Inc.					
Main	Advanced	Chipset	Boot	Security	Save & Exit
Password Description If ONLY the Administrator's password is set, then this only limits access to Setup and is only asked for when entering Setup. If ONLY the User's password is set, then this is a power on password and must be entered to boot or enter Setup. In Setup the User will have Administrator rights. The password must be 3 to 20 characters long.				Set Setup Administrator Password	
Administrator Password User Password				→ ←: Select Screen ↑ ↓: Select Item Enter: Select +/-: Change Opt. F1: General Help F2: Previous Values F3: Optimized Defaults F4: Save & Exit ESC: Exit	
Version 2.11.1210. Copyright (C) 2011 American Megatrends, Inc.					

Administrator Password

Sets the administrator password.

User Password

Sets the user password.

Save & Exit

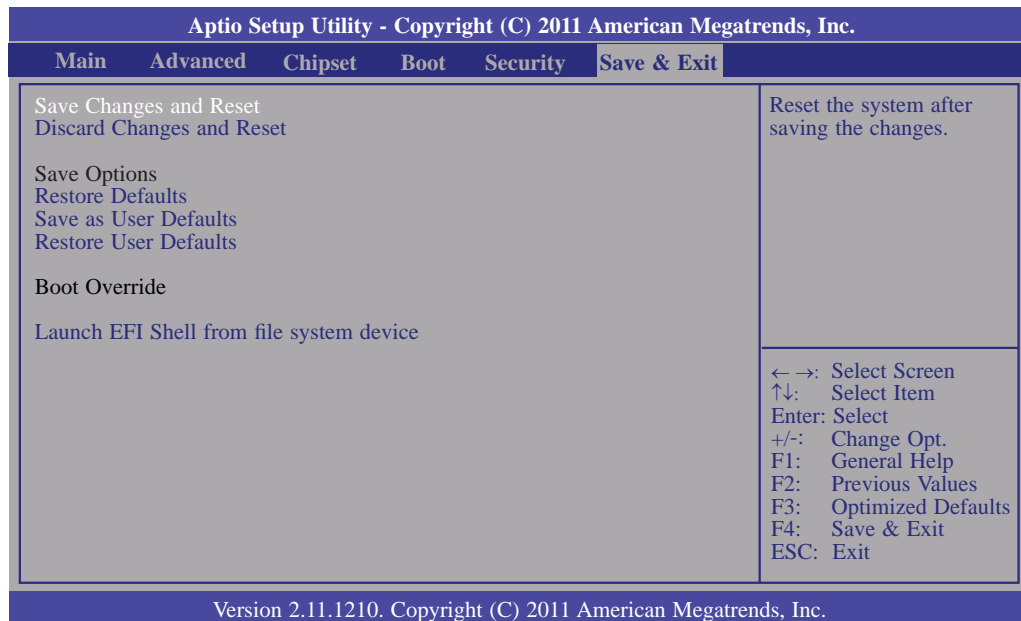

Save Changes and Reset

To save the changes, select this field and then press <Enter>. A dialog box will appear. Select Yes to reset the system after saving all changes made.

Discard Changes and Reset

To discard the changes, select this field and then press <Enter>. A dialog box will appear. Select Yes to reset the system setup without saving any changes.

Restore Defaults

To restore and load the optimized default values, select this field and then press <Enter>. A dialog box will appear. Select Yes to restore the default values of all the setup options.

Save as User Defaults

To save changes done so far as user default, select this field and then press <Enter>. A dialog box will appear. Select Yes to save values as user default.

Restore User Defaults

To restore user default to all the setup options, select this field and then press <Enter>. A dialog box will appear. Select Yes to restore user default.

Updating the BIOS

To update the BIOS, you will need the new BIOS file and a flash utility, AFUDOS.EXE. Please contact technical support or your sales representative for the files.

To execute the utility, type:

```
A: > AFUDOS BIOS_File_Name /b /p /n
```

then press <Enter>.

```
C:\AFU\AFUDOS>afudos filename /B /P /N
+-----+
|              AMI Firmware Update Utility(APTIO) v2.25              |
|              Copyright (C)2008 American Megatrends Inc. All Rights Reserved.              |
+-----+
Reading file ..... done
Erasing flash ..... done
Writing flash ..... done
Verifying flash ..... done
Erasing BootBlock ..... done
Writing BootBlock ..... done
Verifying BootBlock ..... done

C:\AFU\AFUDOS>
```

Chapter 4 - Supported Software

The CD that came with the system board contains drivers, utilities and software applications required to enhance the performance of the system board.

Insert the CD into a CD-ROM drive. The autorun screen (Mainboard Utility CD) will appear. If after inserting the CD, "Autorun" did not automatically start (which is, the Mainboard Utility CD screen did not appear), please go directly to the root directory of the CD and double-click "Setup".

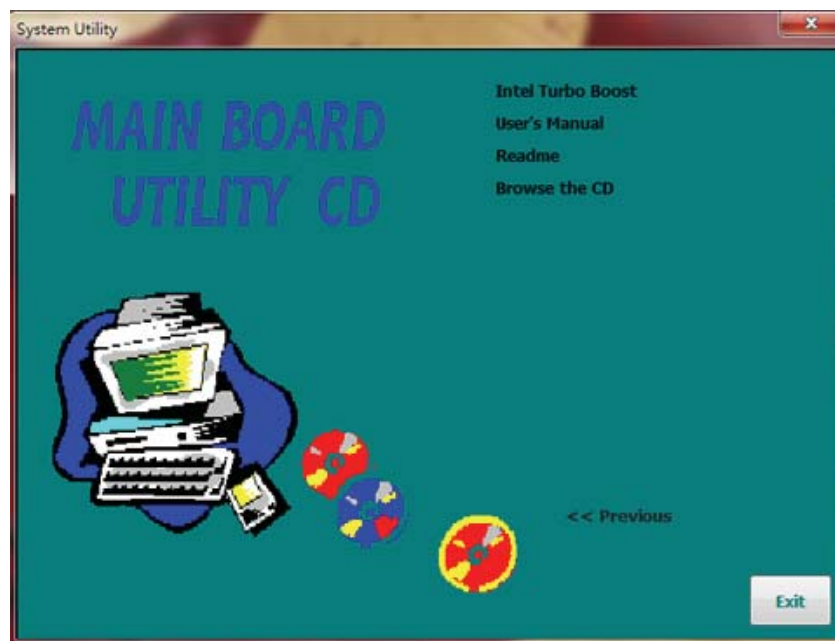
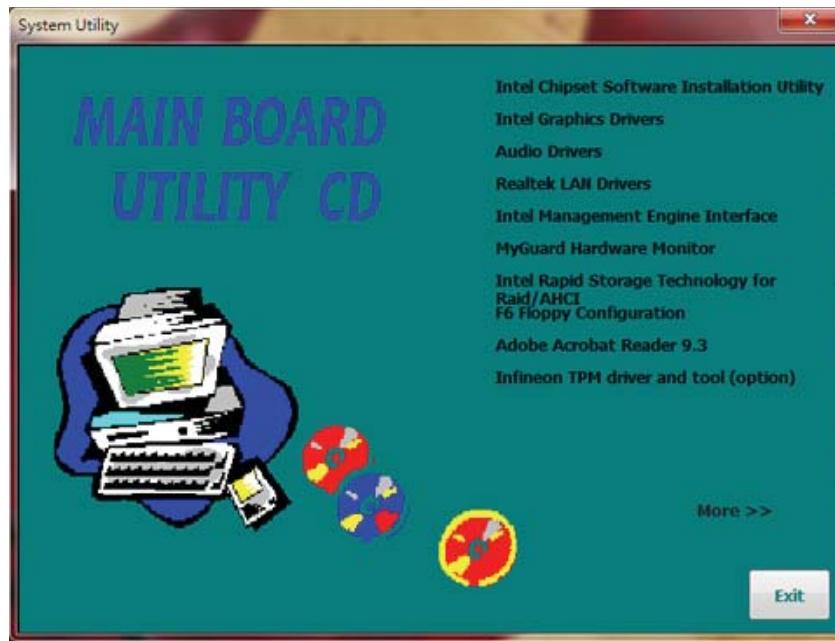

Intel Chipset Software Installation Utility

The Intel Chipset Software Installation Utility is used for updating Windows® INF files so that the Intel chipset can be recognized and configured properly in the system.

To install the utility, click “Intel Chipset Software Installation Utility” on the main menu.

1. Setup is now ready to install the utility. Click Next.



2. Read the license agreement then click Yes.



- Go through the readme document for system requirements and installation tips then click Next.



- Setup is now installing the driver. Click Next to continue.



- Click "Yes, I want to restart this computer now" then click Finish.

Restarting the system will allow the new software installation to take effect.



Intel Graphics Drivers

To install the driver, click “Intel Graphics Drivers” on the main menu.

1. Setup is now ready to install the graphics driver. Click Next.



By default, the “Automatically run WinSAT and enable the Windows Aero desktop theme” is enabled. With this enabled, after installing the graphics driver and the system rebooted, the screen will turn blank for 1 to 2 minutes (while WinSAT is running) before the Windows Vista desktop appears. The “blank screen” period is the time Windows is testing the graphics performance.

We recommend that you skip this process by disabling this function then click Next.

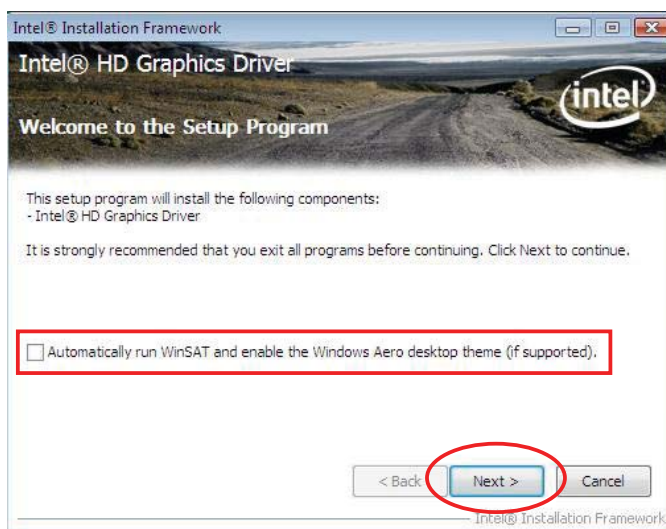

2. Read the license agreement then click Yes.

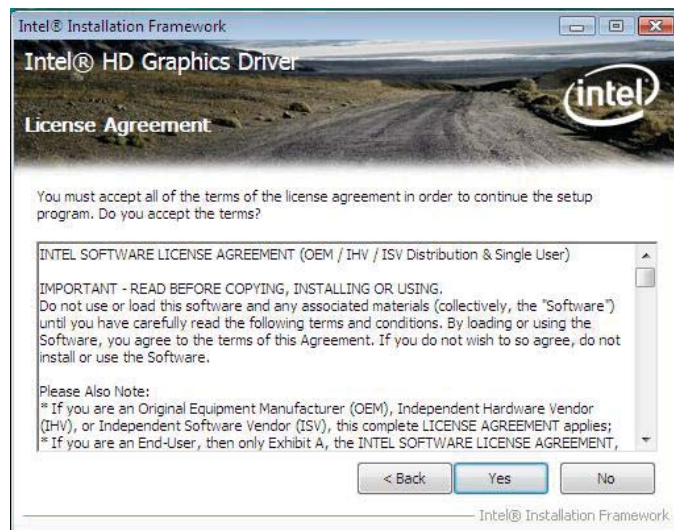

3. Go through the readme document for system requirements and installation tips then click Next.

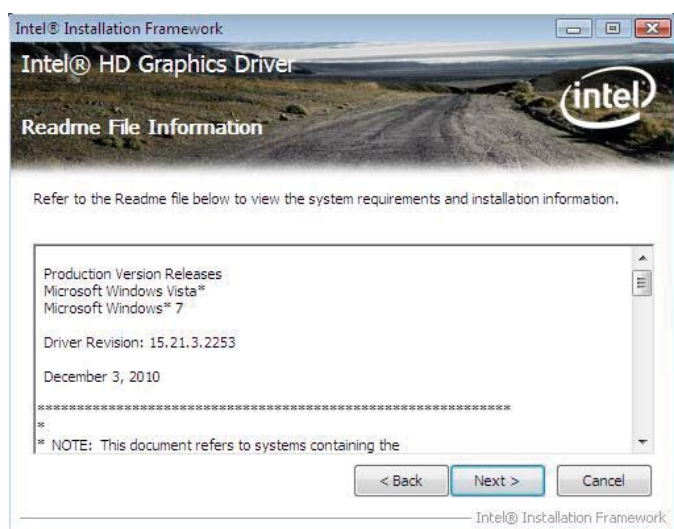

4. Setup is currently installing the driver. After installation has completed, click Next.

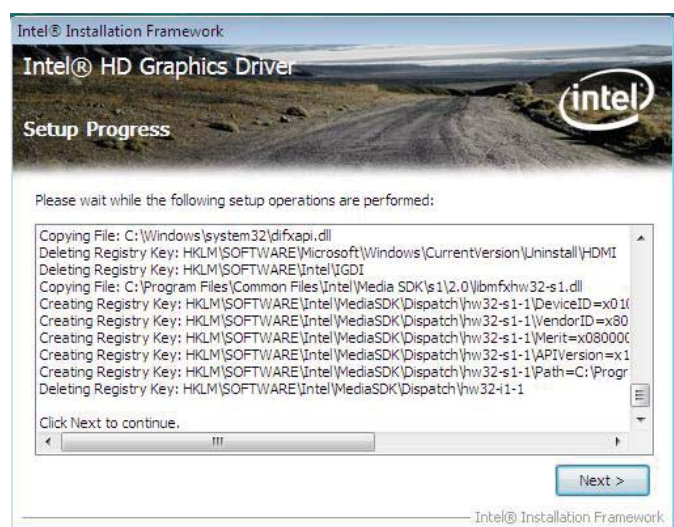

5. Click “Yes, I want to restart this computer now” then click Finish.

Restarting the system will allow the new software installation to take effect.

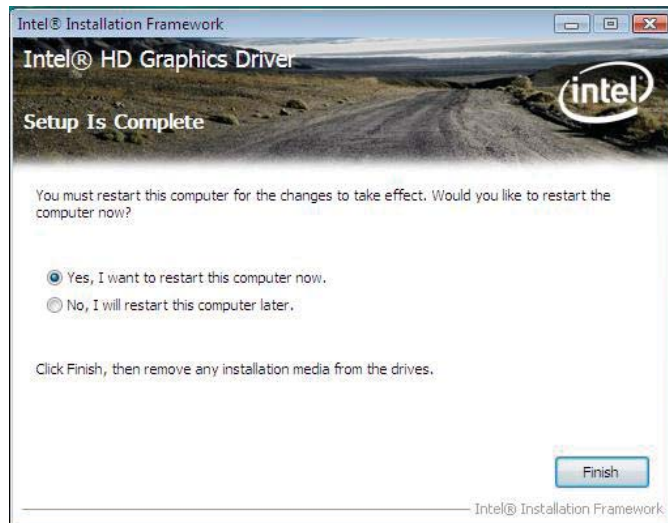

Audio Drivers

To install the driver, click “Audio Drivers” on the main menu.

1. Setup is now ready to install the audio driver. Click Next.
2. Follow the remainder of the steps on the screen; clicking “Next” each time you finish a step.

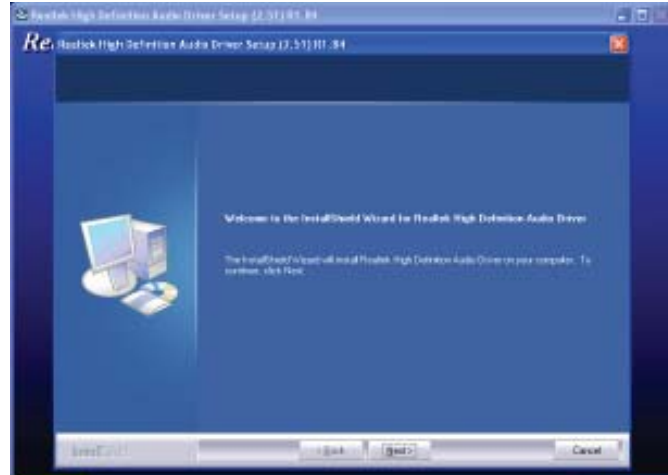

3. Click “Yes, I want to restart my computer now” then click Finish.

Restarting the system will allow the new software installation to take effect.

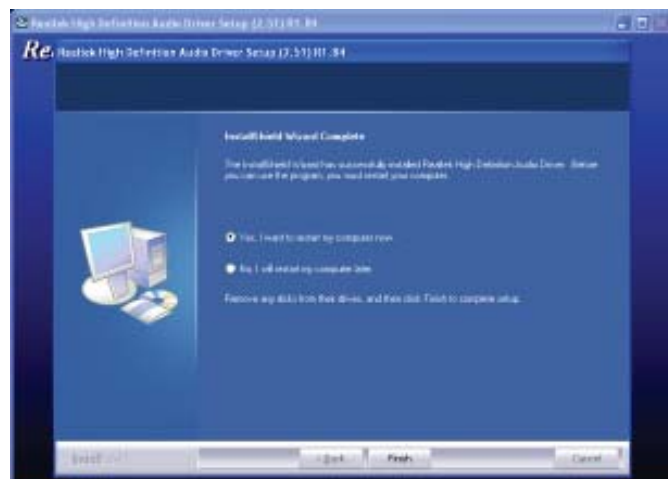

Realtek LAN Drivers

To install the driver, click “Realtek LAN Drivers” on the main menu.

1. Setup is ready to install the driver. Click Next.

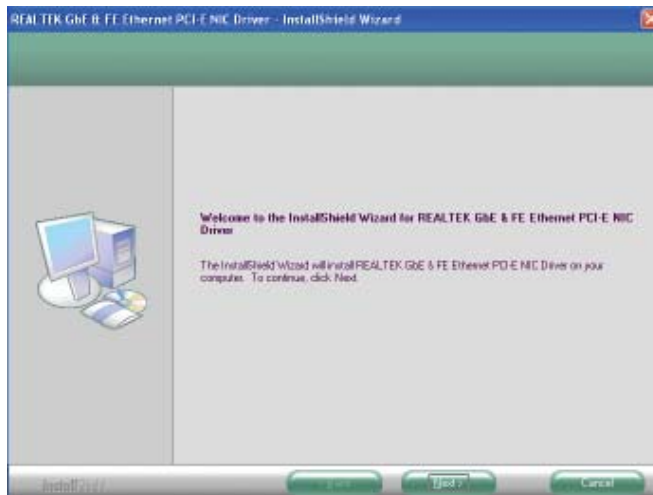

2. Click Install to begin the installation.

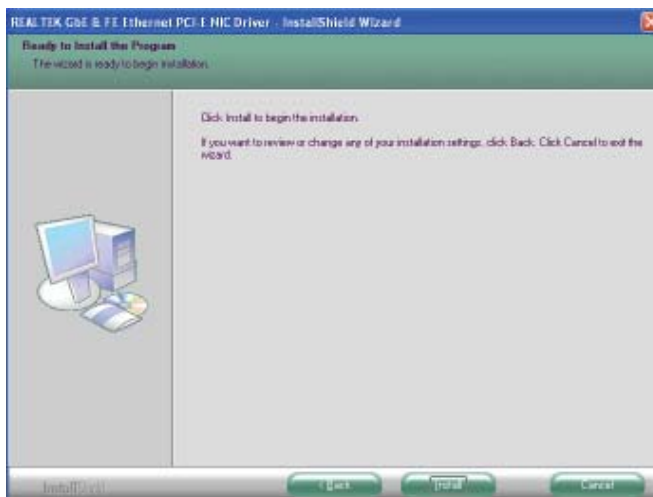

3. After completing installation, click Finish.

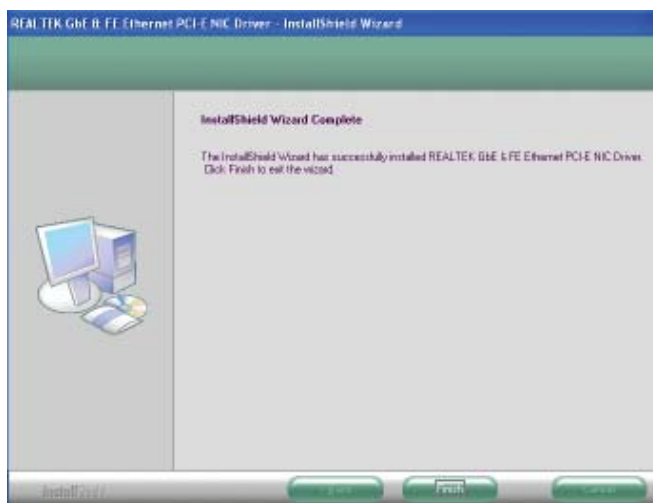

Intel Management Engine Interface

To install the driver, click "Intel Management Engine Interface" on the main menu.

1. Setup is ready to install the driver. Click Next.

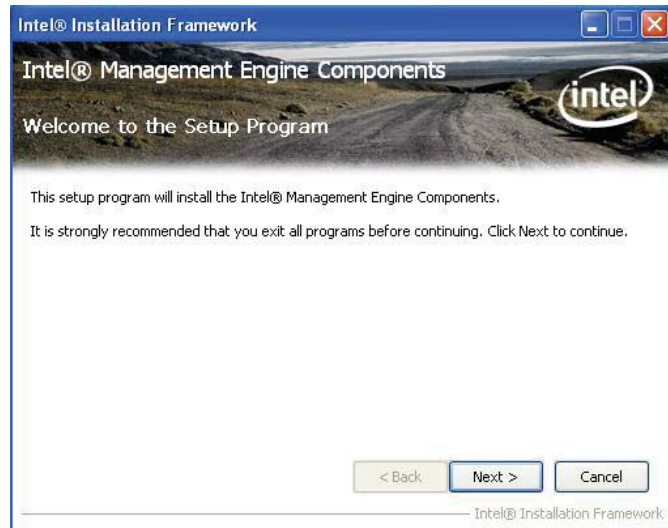

2. Read the license agreement then click Yes.



3. Go through the readme document for more installation tips then click Next.



4. Setup is currently installing the driver. After installation has completed, click Next.

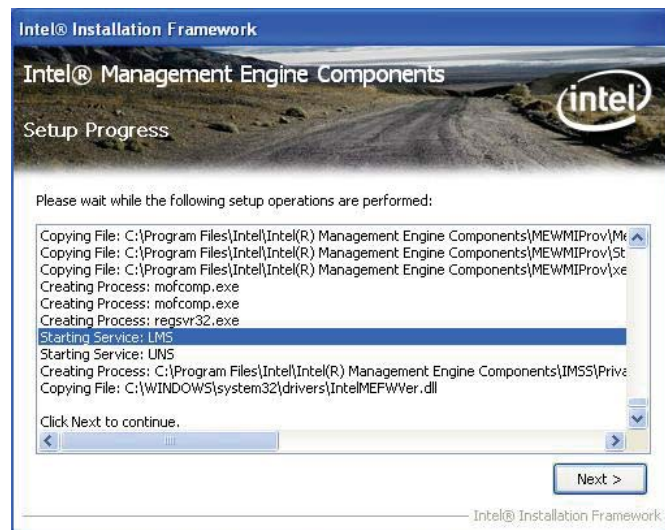

5. After completing installation, click Finish.



MyGuard Hardware Monitor

1. Locate for the MyGuard folder in the provided disc.
2. In the MyGuard folder, right-click on the "setup" file.
3. Select Run As Administrator.
4. Double-click Setup.

Important:
Perform steps 1-3 only when using Windows 7 or Windows Vista.

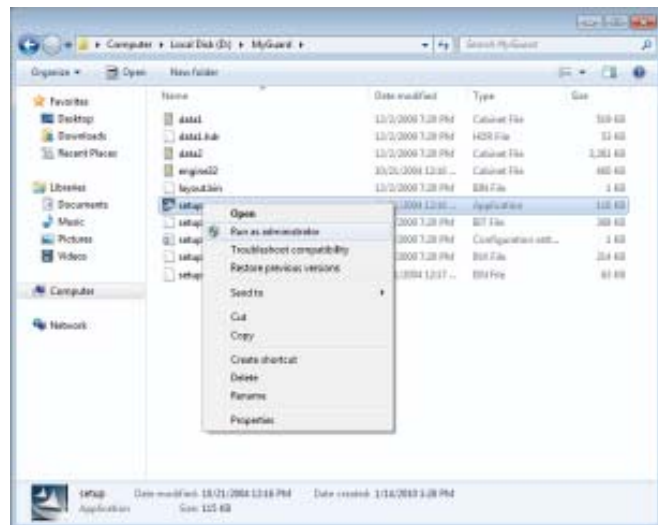

5. Setup is ready to install the utility. Click Next.

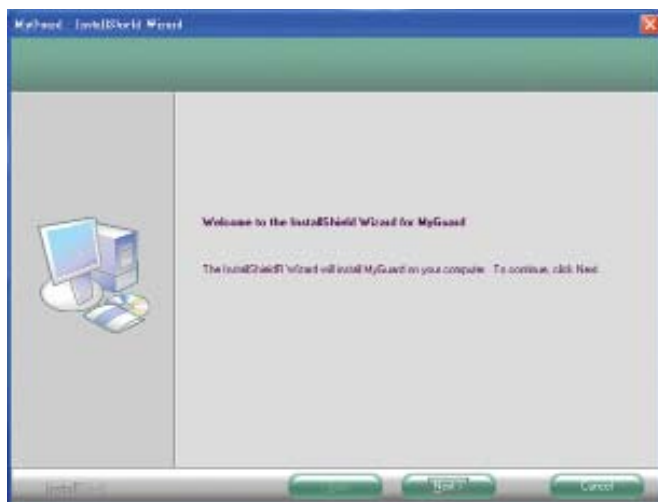

6. Click Install to begin installation.

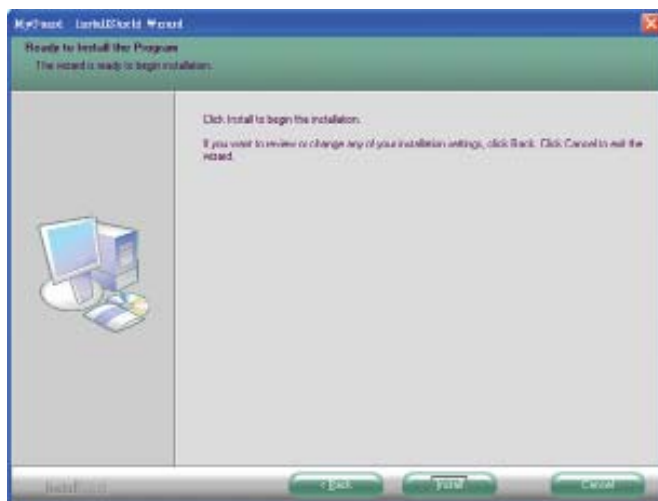

7. Setup is currently installing the utility.

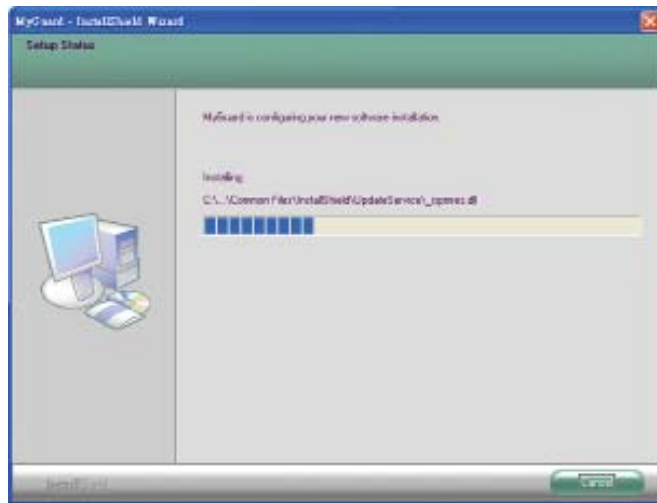

8. After completing installation, click Finish to exit setup.

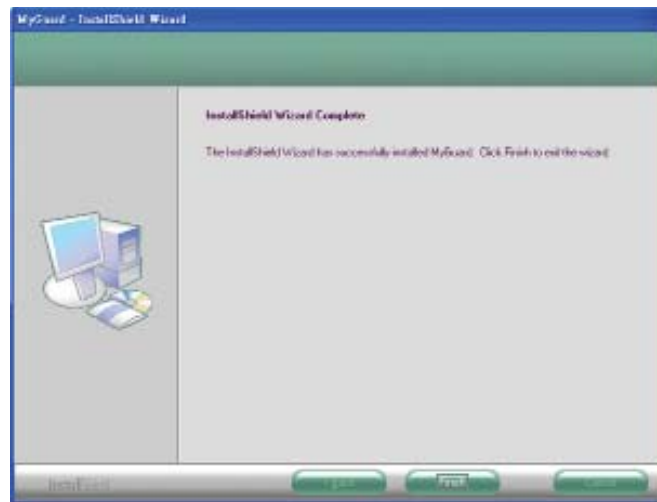

Intel Rapid Storage Technology

To install the driver, click "Intel Rapid Storage Technology" on the main menu.

1. Setup is ready to install the driver. Click Next.



2. Read the warning carefully then click Yes.



3. Read the license agreement then click Yes.



- Go through the readme document to view system requirements and installation information then click Next.

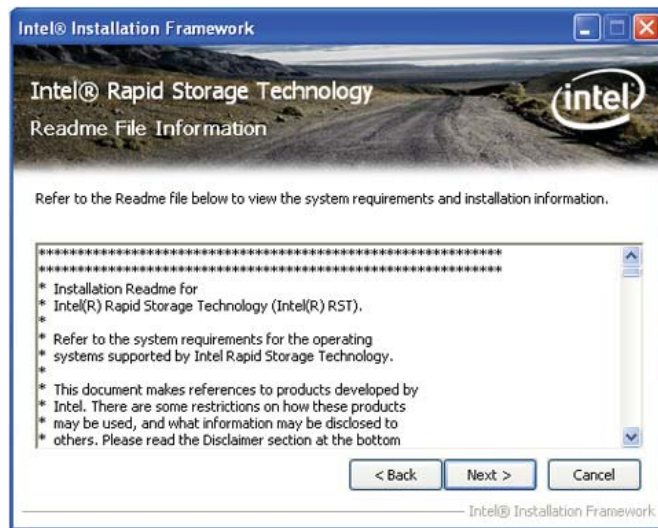

- Setup is currently installing the driver. After installation has completed, click Next.

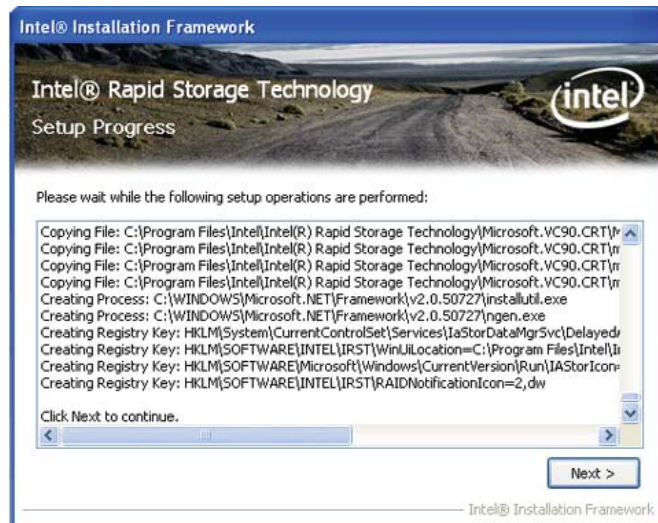

- Click "Yes, I want to restart my computer now" then click Finish.



F6 Floppy Configuration Utility

This is used to create a floppy driver diskette needed when you install Windows® XP using the F6 installation method. This will allow you to install the operating system onto a hard drive when in AHCI mode.

1. Insert a blank floppy diskette.
2. Locate for the drivers in the CD then copy them to the floppy diskette. The CD includes drivers for both 32-bit and 64-bit operating systems. The path to the drivers are shown below.

32-bit

CD Drive: \AHCI_RAID\F6FLOPPY\f6flpy32

64-bit

CD Drive: \AHCI_RAID\F6FLOPPY\f6flpy64

Adobe Acrobat Reader 9.3

To install the reader, click "Adobe Acrobat Reader 9.3" on the main menu.

1. Click Next to install or click Change Destination Folder to select another folder.



2. Click Install to begin installation.



3. Click Finish to exit installation.

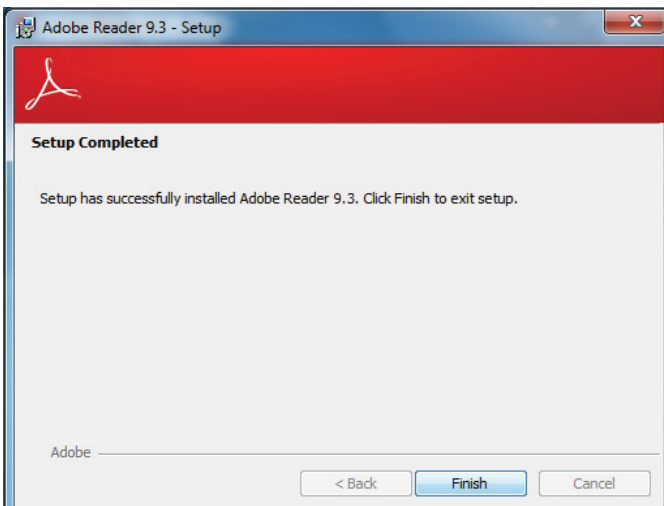

Infineon TPM Driver and Tool (optional)

To install the driver, click “Infineon TPM driver and tool (option)” on the main menu.

1. TPM requires installing the Microsoft Visual C++ package prior to installing the driver. Click Install.

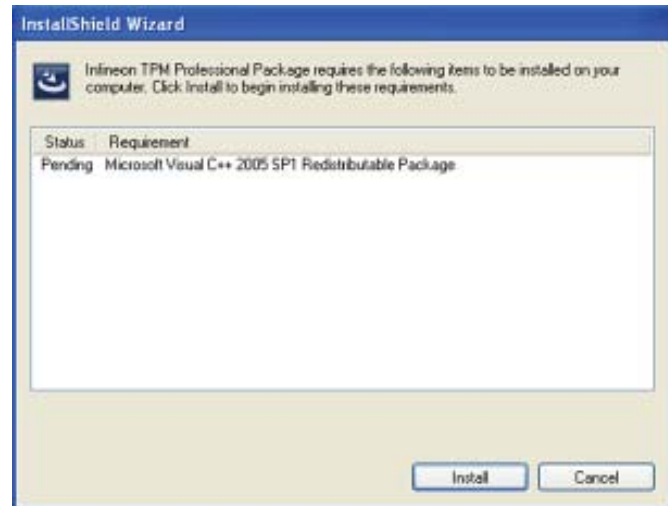

2. The setup program is preparing to install the driver.



3. The setup program is ready to install the driver. Click Next.



- Click "I accept the terms in the license agreement" and then click "Next".



- Enter the necessary information and then click Next.



- Select a setup type and then click Next.



7. Click Install.



8. The setup program is currently installing the driver.



9. Click Finish.



10. Click Yes to restart the system.

Restarting the system will allow the new software installation to take effect.

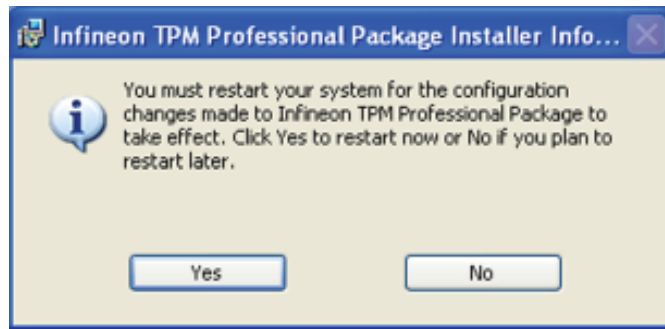

Intel Turbo Boost

To install the driver, click “Intel Turbo Boost” on the main menu.

1. The setup program is configuring the new software installation.



2. Click Next.



3. Read the license agreement and then click “I accept the terms in the license agreement”. Click Next.



4. Click Install.



5. The setup program is currently installing the software.



6. Click Finish.



Appendix A - NLITE and AHCI Installation Guide

nLite

nLite is an application program that allows you to customize your XP installation disc by integrating the RAID/AHCI drivers into the disc. By using nLite, the F6 function key usually required during installation is no longer needed.



Note:

The installation steps below are based on nLite version 1.4.9. Installation procedures may slightly vary if you're using another version of the program.

1. Download the program from nLite's official website.

<http://www.nliteos.com/download.html>

2. Install nLite.



Important:

Due to its coding with Visual.Net, you may need to first install .NET Framework prior to installing nLite.

3. Download relevant RAID/AHCI driver files from Intel's website. The drivers you choose will depend on the operating system and chipset used by your computer.

The downloaded driver files should include iaahci.cat, iaAHCI.inf, iastor.cat, iaStor.inf, iaStor.sys, license.txt and TXTSETUP.OEM.

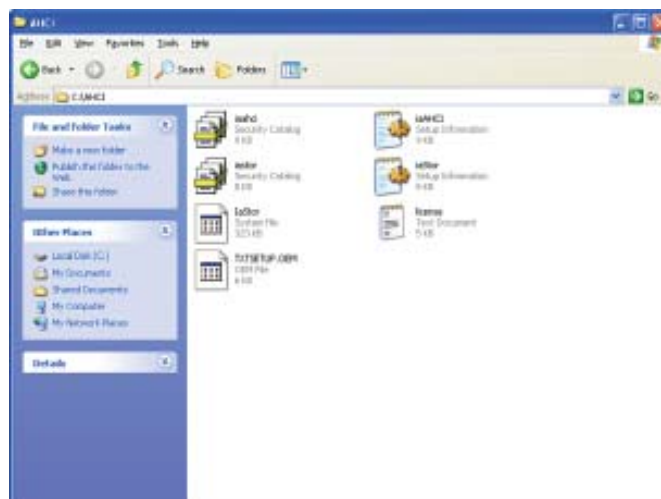

4. Insert the XP installation disc into an optical drive.
5. Launch nLite. The Welcome screen will appear. Click **Next**.

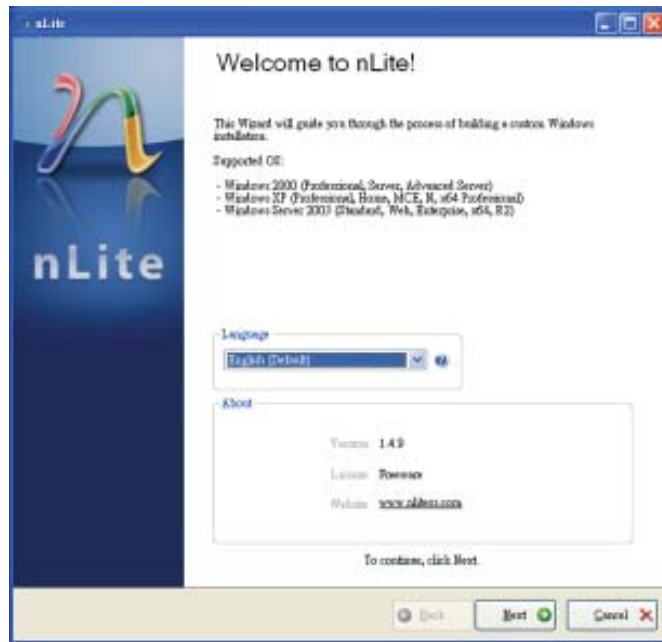

6. Click **Next** to temporarily save the Windows installation files to the designated default folder.

If you want to save them in another folder, click **Browse**, select the folder and then click **Next**.

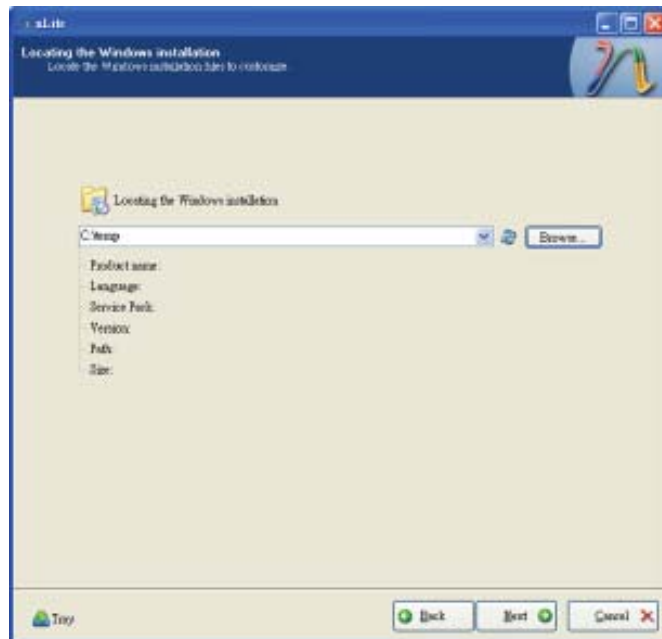

7. Click **Next**.

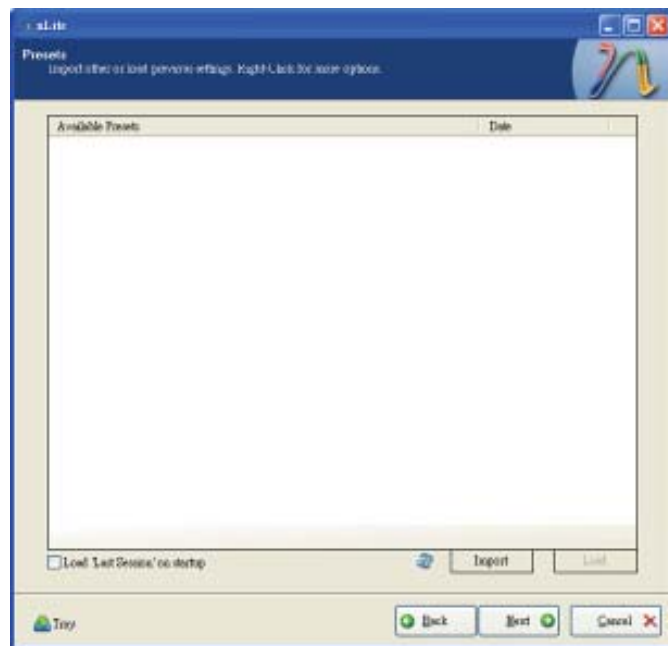

8. In the Task Selection dialog box, click **Drivers** and **Bootable ISO**. Click **Next**.

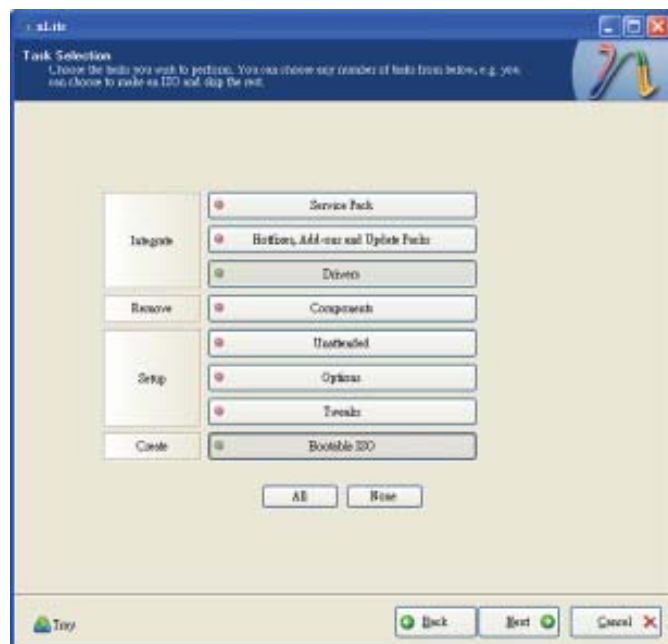

- Click **Insert** and then select **Multiple driver folder** to select the drivers you will integrate. Click **Next**.

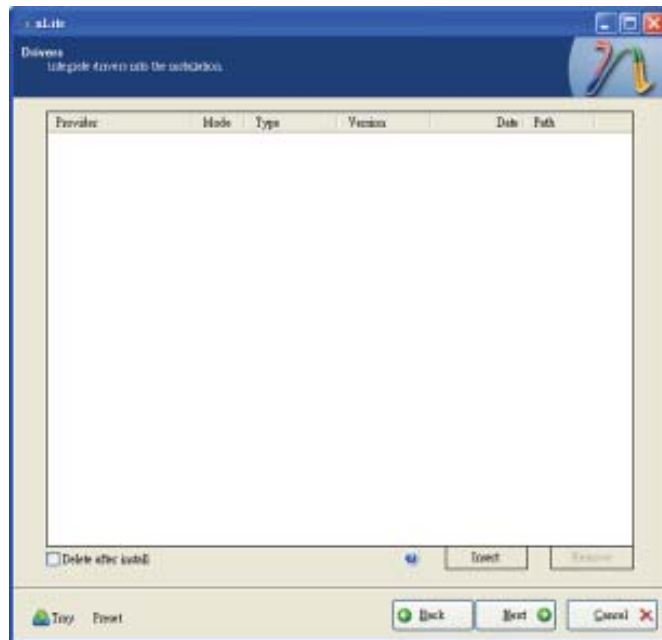

- Select only the drivers appropriate for the Windows version that you are using and then click **OK**.

Integrating 64-bit drivers into 32-bit Windows or vice versa will cause file load errors and failed installation.

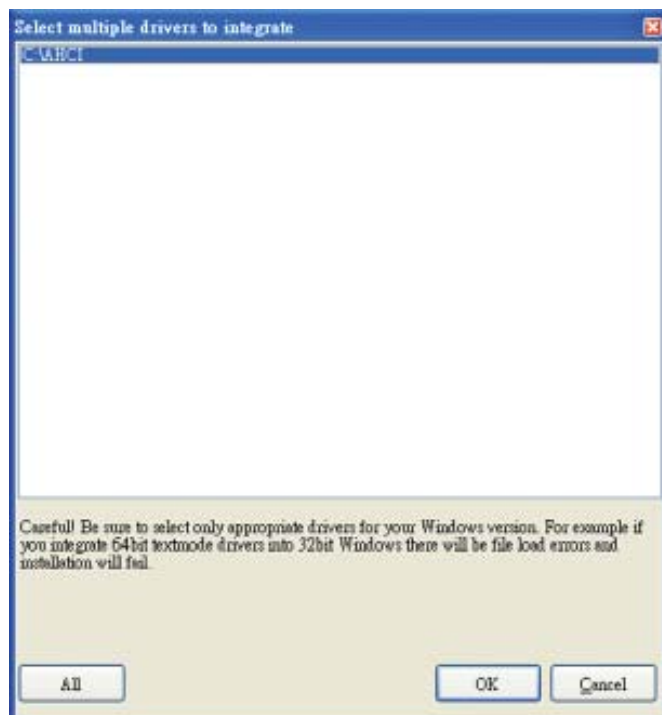

13. The program is currently integrating the drivers and applying changes to the installation.

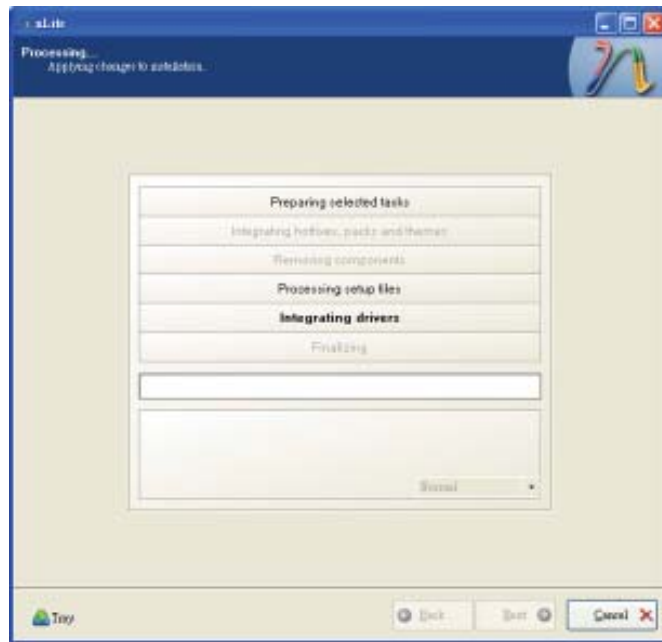

14. When the program is finished applying the changes, click **Next**.

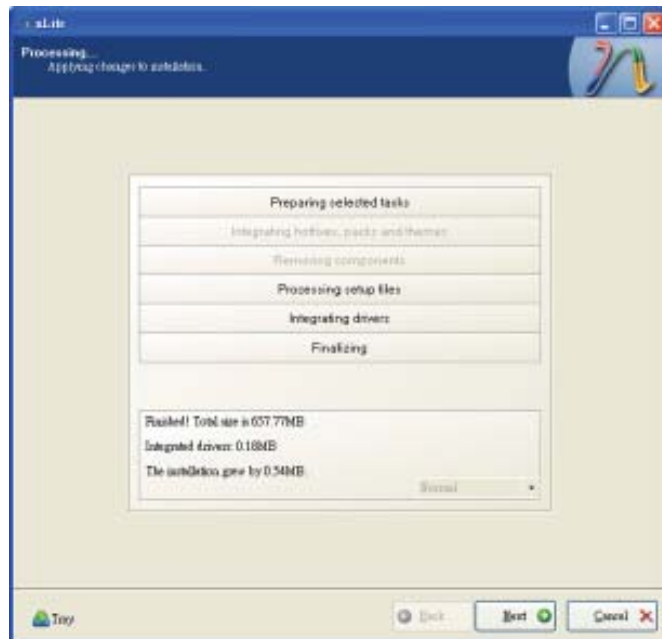

15. To create an image, select the **Create Image** mode under the General section and then click **Next**.

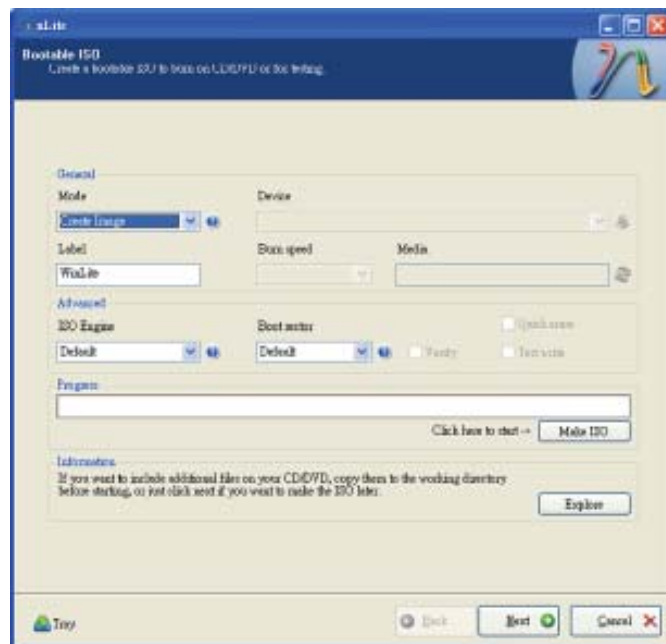

16. Or you can choose to burn it directly to a disc by selecting the **Direct Burn** mode under the General section.

Select the optical device and all other necessary settings and then click **Next**.

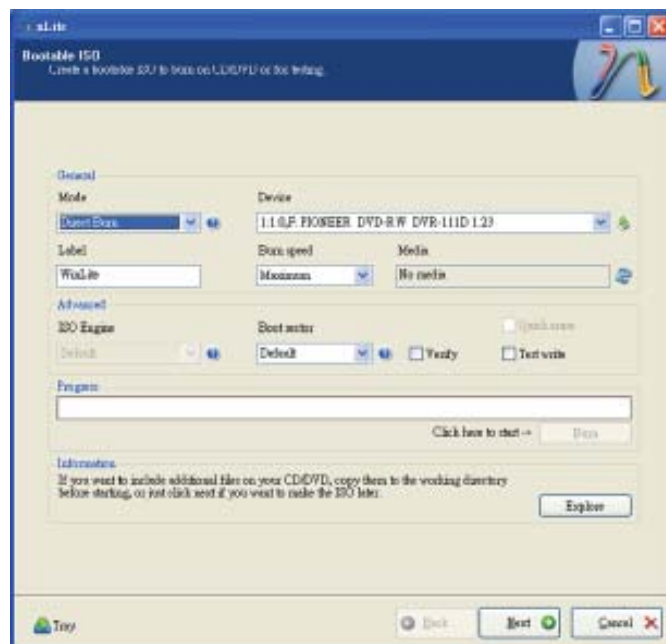

17. You have finished customizing the Windows XP installation disc. Click **Finish**.

Enter the BIOS utility to configure the SATA controller to RAID/AHCI. You can now install Windows XP.

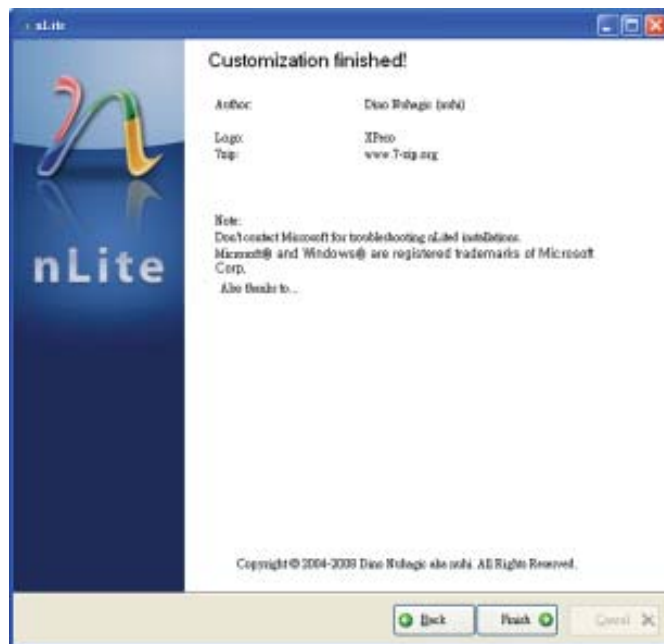

- In the Hardware Update Wizard dialog box, select **“No, not this time”** then click **Next**.



- Select **“Install from a list or specific location (Advanced)”** and then click **Next**.

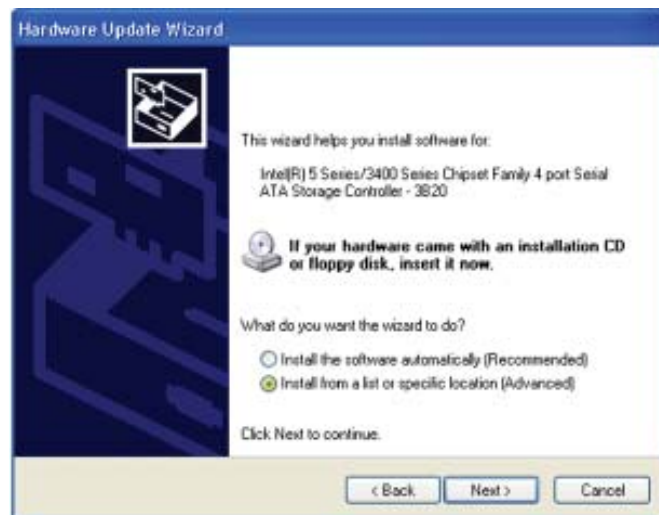

- Select **“Don't search. I will choose the driver to install”** and then click **Next**.

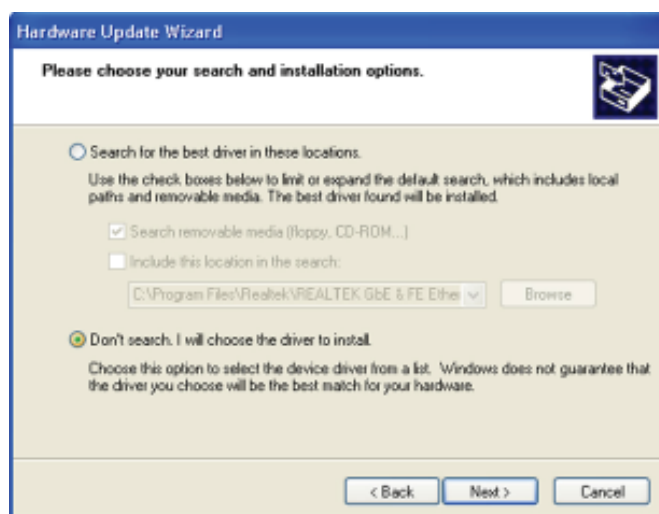

8. Click **"Have Disk"**.

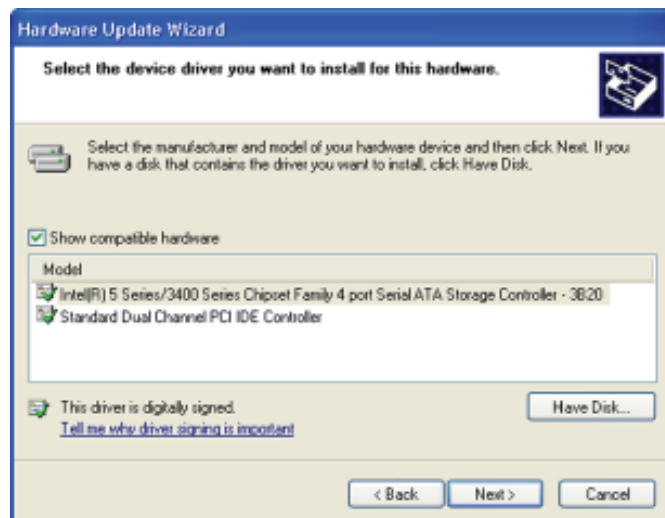

9. Select `C:\AHCI\iaAHCI.inf` and then click **Open**.

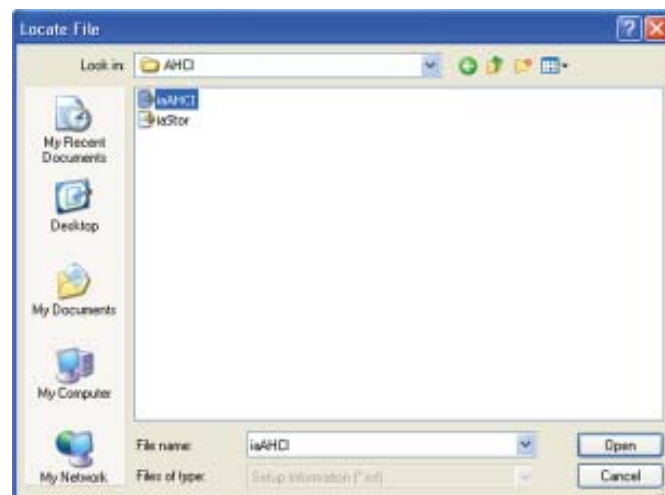

10. Select the appropriate AHCI Controller of your hardware device and then click **Next**.

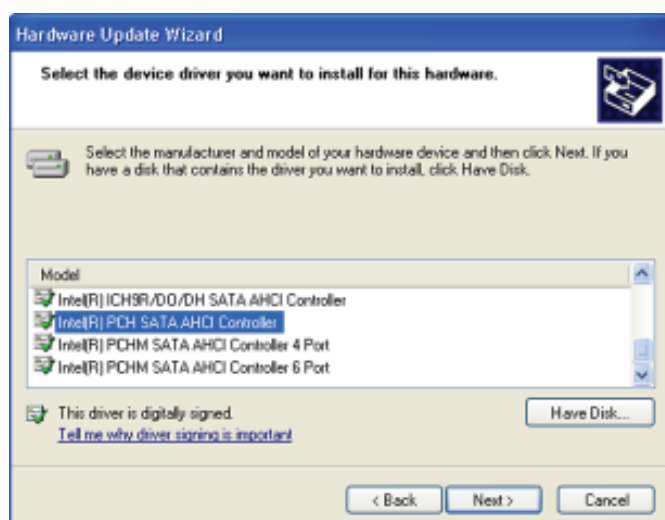

11. A warning message appeared because the selected SATA controller did not match your hardware device.



Ignore the warning and click **Yes** to proceed.

12. Click **Finish**.

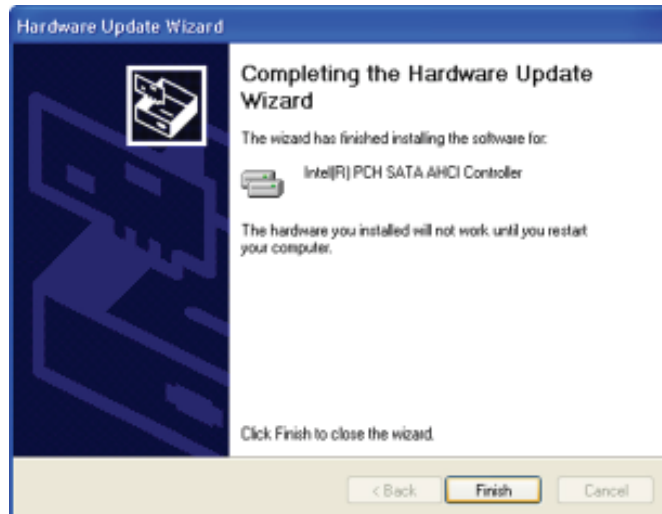

13. The system's settings have been changed. Windows XP requires that you restart the computer. Click **Yes**.

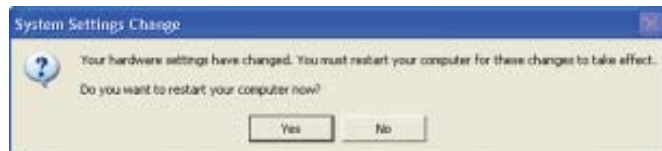

14. Enter the BIOS utility and modify the SATA controller from IDE to AHCI. By doing so, Windows will work normally with the SATA controller that is in AHCI mode.

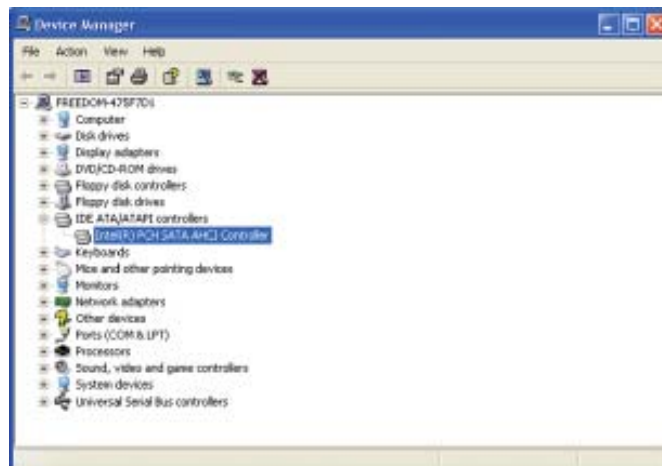

Appendix B - Watchdog Sample Code

;Software programming example:

```
-----  
;(1) Enter Super IO Configuration mode  
-----  
MOV     DX,2EH  
MOV     AL,87H  
OUT     DX,AL  
OUT     DX,AL  
  
-----  
;(2) Configuration Logical Device 7, register CRF5/CRF6 (WDT Control /WDT  
timer)  
-----  
MOV     DX,2EH  
MOV     AL,07H           ;Ready to Program Logical Device  
OUT     DX,AL  
  
MOV     DX,2FH  
MOV     AL,07H           ;Select Logical Device 7  
OUT     DX,AL  
  
MOV     DX,2EH  
MOV     AL, F6H           ;Select watchdog timer register  
OUT     DX,AL  
  
MOV     DX,2FH  
MOV     AL,10H           ;Set watchdog timer value  
OUT     DX,AL  
  
MOV     DX,2EH  
MOV     AL, F5H           ;Select watchdog Control Register  
OUT     DX,AL  
  
MOV     DX,2FH  
MOV     AL,61H           ;Set Watchdog Control Value  
OUT     DX,AL  
  
-----  
;(1) Exit extended function mode  
-----  
MOV     DX,2EH  
MOV     AL,AAH  
OUT     DX,AL
```

Appendix C - System Error Message

When the BIOS encounters an error that requires the user to correct something, either a beep code will sound or a message will be displayed in a box in the middle of the screen and the message, PRESS F1 TO CONTINUE, CTRL-ALT-ESC or DEL TO ENTER SETUP, will be shown in the information box at the bottom. Enter Setup to correct the error.

Error Messages

One or more of the following messages may be displayed if the BIOS detects an error during the POST. This list indicates the error messages for all Awards BIOSes:

CMOS BATTERY HAS FAILED

The CMOS battery is no longer functional. It should be replaced.



Important

Danger of explosion if battery incorrectly replaced. Replace only with the same or equivalent type recommended by the manufacturer. Dispose of used batteries according to the battery manufacturer's instructions.

CMOS CHECKSUM ERROR

Checksum of CMOS is incorrect. This can indicate that CMOS has become corrupt. This error may have been caused by a weak battery. Check the battery and replace if necessary.

DISPLAY SWITCH IS SET INCORRECTLY

The display switch on the motherboard can be set to either monochrome or color. This indicates the switch is set to a different setting than indicated in Setup. Determine which setting is correct, either turn off the system and change the jumper or enter Setup and change the VIDEO selection.

FLOPPY DISK(S) fail (80)

Unable to reset floppy subsystem.

FLOPPY DISK(S) fail (40)

Floppy type mismatch.

Hard Disk(s) fail (80)

HDD reset failed.

Hard Disk(s) fail (40)

HDD controller diagnostics failed.

Hard Disk(s) fail (20)

HDD initialization error.

Hard Disk(s) fail (10)

Unable to recalibrate fixed disk.

Hard Disk(s) fail (08)

Sector Verify failed.

Keyboard is locked out - Unlock the key

The BIOS detects that the keyboard is locked. Keyboard controller is pulled low.

Keyboard error or no keyboard present

Cannot initialize the keyboard. Make sure the keyboard is attached correctly and no keys are being pressed during the boot.

Manufacturing POST loop

System will repeat POST procedure infinitely while the keyboard controller is pull low. This is also used for the M/B burn in test at the factory.

BIOS ROM checksum error - System halted

The checksum of ROM address F0000H-FFFFFFH is bad.

Memory test fail

The BIOS reports memory test fail if the memory has error(s).

Appendix D - Troubleshooting

Troubleshooting Checklist

This chapter of the manual is designed to help you with problems that you may encounter with your personal computer. To efficiently troubleshoot your system, treat each problem individually. This is to ensure an accurate diagnosis of the problem in case a problem has multiple causes.

Some of the most common things to check when you encounter problems while using your system are listed below.

1. The power switch of each peripheral device is turned on.
2. All cables and power cords are tightly connected.
3. The electrical outlet to which your peripheral devices are connected is working. Test the outlet by plugging in a lamp or other electrical device.
4. The monitor is turned on.
5. The display's brightness and contrast controls are adjusted properly.
6. All add-in boards in the expansion slots are seated securely.
7. Any add-in board you have installed is designed for your system and is set up correctly.

Monitor/Display

If the display screen remains dark after the system is turned on:

1. Make sure that the monitor's power switch is on.
2. Check that one end of the monitor's power cord is properly attached to the monitor and the other end is plugged into a working AC outlet. If necessary, try another outlet.
3. Check that the video input cable is properly attached to the monitor and the system's display adapter.
4. Adjust the brightness of the display by turning the monitor's brightness control knob.

The picture seems to be constantly moving.

1. The monitor has lost its vertical sync. Adjust the monitor's vertical sync.
2. Move away any objects, such as another monitor or fan, that may be creating a magnetic field around the display.
3. Make sure your video card's output frequencies are supported by this monitor.

The screen seems to be constantly wavering.

1. If the monitor is close to another monitor, the adjacent monitor may need to be turned off. Fluorescent lights adjacent to the monitor may also cause screen wavering.

Power Supply

When the computer is turned on, nothing happens.

1. Check that one end of the AC power cord is plugged into a live outlet and the other end properly plugged into the back of the system.
2. Make sure that the voltage selection switch on the back panel is set for the correct type of voltage you are using.
3. The power cord may have a "short" or "open". Inspect the cord and install a new one if necessary.

Floppy Drive

The computer cannot access the floppy drive.

1. The floppy diskette may not be formatted. Format the diskette and try again.
2. The diskette may be write-protected. Use a diskette that is not write-protected.
3. You may be writing to the wrong drive. Check the path statement to make sure you are writing to the targeted drive.
4. There is not enough space left on the diskette. Use another diskette with adequate storage space.

Hard Drive

Hard disk failure.

1. Make sure the correct drive type for the hard disk drive has been entered in the BIOS.
2. If the system is configured with two hard drives, make sure the bootable (first) hard drive is configured as Master and the second hard drive is configured as Slave. The master hard drive must have an active/bootable partition.

Excessively long formatting period.

If your hard drive takes an excessively long period of time to format, it is likely a cable connection problem. However, if your hard drive has a large capacity, it will take a longer time to format.

Serial Port

The serial device (modem, printer) doesn't output anything or is outputting garbled characters.

1. Make sure that the serial device's power is turned on and that the device is on-line.
2. Verify that the device is plugged into the correct serial port on the rear of the computer.
3. Verify that the attached serial device works by attaching it to a serial port that is working and configured correctly. If the serial device does not work, either the cable or the serial device has a problem. If the serial device works, the problem may be due to the onboard I/O or the address setting.
4. Make sure the COM settings and I/O address are configured correctly.

Keyboard

Nothing happens when a key on the keyboard was pressed.

1. Make sure the keyboard is properly connected.
2. Make sure there are no objects resting on the keyboard and that no keys are pressed during the booting process.

System Board

1. Make sure the add-in card is seated securely in the expansion slot. If the add-in card is loose, power off the system, re-install the card and power up the system.
2. Check the jumper settings to ensure that the jumpers are properly set.
3. Verify that all memory modules are seated securely into the memory sockets.
4. Make sure the memory modules are in the correct locations.
5. If the board fails to function, place the board on a flat surface and seat all socketed components. Gently press each component into the socket.
6. If you made changes to the BIOS settings, re-enter setup and load the BIOS defaults.