

# BROMIC®

## Operation Manual



### Display Freezer



Thank you for purchasing our product. Please read this operation manual carefully before operating the product. Please keep this manual in a safe place for future reference.

#### Contents :-

- Installation .....	2
- Safety Precautions And Warnings .....	3
- Important Warnings .....	3
- Explosive Drawings .....	4
- Components Lists .....	5
- Circuit Diagram .....	5
- Maintenance .....	6
- Before Calling For Service .....	7
- Memo .....	7

## **INSTALLATION**

1- Select a good location. Place your refrigerator where it is easy to use. Do not tilt more than 45° during transportation.

2- **WARNING:** 3 Door Chillers are fitted with Bullet Feet to provide stability. It should be adjusted before using and opening all the doors. Screw down the bullet feet clockwise until it is firmly contact with the floor. Make sure ALL Bullet Feet are firmly contact with the floor”.

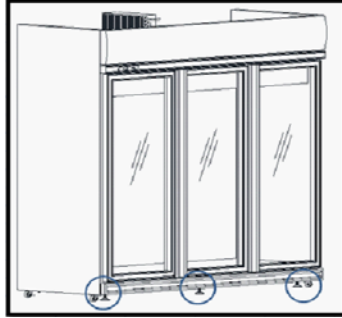

3- Avoid placing the unit near heat sources, direct sunlight or moisture.

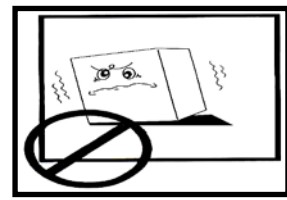
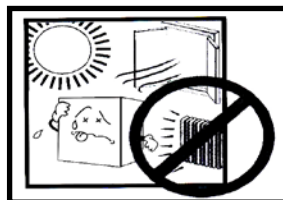

4- There must be proper air circulation around your refrigerator to keep it operating efficiently. The space between the cabinet and any wall should be at least 10 cm.

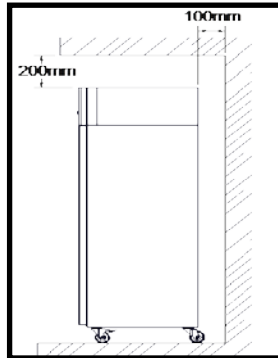

5- To avoid vibrations, the unit must be level.

6- Install this appliance between 10°C and 32°C. If the temperature around the appliance is too low or high, cooling ability may lessen

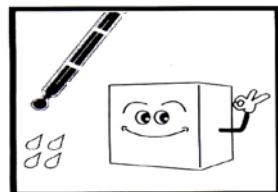
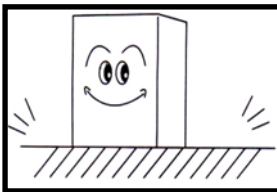

7- Unit is tested according to MEPS Standard under Climate Class 3 – which have an Ambient Temperature of 25°C and 60% Rh.

## **NEXT**

1- Clean your refrigerator thoroughly and wipe off all dust accumulated during transportation.

2- Connect the power supply cord (or plug) to the supply outlet. Don't double up with other appliances on the same supply outlet.

3- Prior to storing food, leave your refrigerator on for 2 or 3 hours to ensure proper cooling. Your refrigerator is now ready for use.

4- The shelving is adjustable in multi-steps. So the shelf spacing can be adjusted to the food stored in the case.

## **OPERATION**

- The digital thermometer is pre-set by factory. Any changes required, please refer to Dixell instruction.

**CLEANING**

- It is important that your refrigerator be kept clean to prevent undesirable odors. Spilled food should be wiped off immediately, since acidity can stain plastic surface. Never use metallic scouring pads, brushes, coarse abrasive cleaners or strong alkaline solutions on any surface.

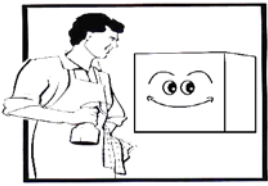

Exterior - Use a lukewarm solution of mild soap or detergent to clean the external of your refrigerator. Wipe with a clean, damp cloth and then dry.

Interior - Regular cleaning of the interior parts is recommended. Wash compartment shelves, door racks, storage trays and magnetic door seals etc, with a baking soda solution or mild detergent and warm water. Then rinse and dry them.

**SAFETY PRECAUTION**

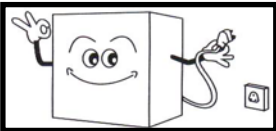

Always remove power cord from the wall outlet prior to cleaning in the vicinity of electrical parts (lamps, switches, controller etc.) Wipe up excess moisture with a sponge or cloth to prevent water or liquid from getting into any electrical part and causing an electric short circuit. Do not use flammable or toxic cleaning liquids. Never spill water directly into the unit.

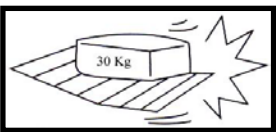
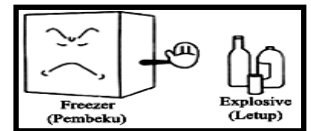

Avoid overload the shelves. Attach and secure properly to avoid collapse and cause injury. Maximum load capacity of each shelf is 30kg (66 lbs).

Ensure the shelving stoppers are locating at the rear of the internal cabinet in order to allow proper air circulation during operating.

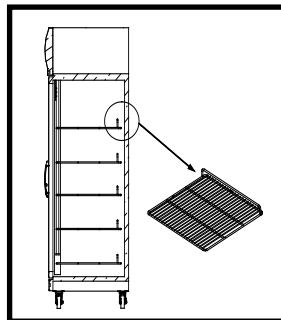

**IMPORTANT WARNINGS**

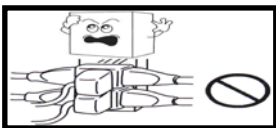

**Do Not Use Extension Cord**

If possible, connect the refrigerator to its own individual electrical supply outlet to prevent it and other appliance or household lights from causing an overload that could cause a power failure. Disassembling, repairing or modifying the product by any unqualified person is prohibited.

**Power Cord Replacement**

If the supply cord is damaged, it must be replaced by a special cord or assembly from the manufacturer or its service agent.

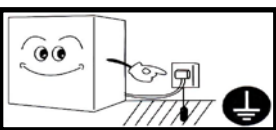
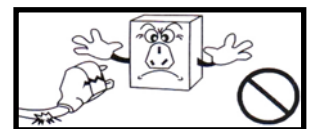

**About Grounding (Earthing)**

In the event of an electric short circuit, grounding (earthing) reduces the risk of electric shock by providing an escape wire for the electric current. In order to prevent possible electric shock, this appliance must be grounded. Improper use of the grounding plug can result in an electric shock. Consult a qualified electrician or service person if the grounding instructions are not completely understood, or if you have doubts on whether the appliance is properly grounded.

**\* This appliance must be grounded (earthed). DO NOT WAIT!! DO IT NOW!**

Do not place the appliances nearby the gas cylinder, it may cause explosion.

If there is a power failure, switch on the power 5 minutes later to avoid damaging the compressor.

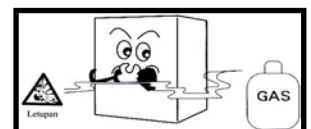

“Note : If supply voltage fluctuates beyond +10%, a stabilizer is required. The input voltage of stabilizer is recommended to be +25% and output voltage to +5%.”

**FOOD HANDLING**

Ways of storing food before putting into refrigerator

- 1- All packaging's are to be wiped with cloth.
- 2- All perishable food is to wrap with plastic bags or stretch film. This is to keep food clean and moisture evaporation.
- 3- All temperature hot food is to be cooled outside.
- 4- Vegetables and fruits are to be put at higher shelves and non-perishable food at lower shelves.
- 5- Allow ample space for ventilation and heat transfer.











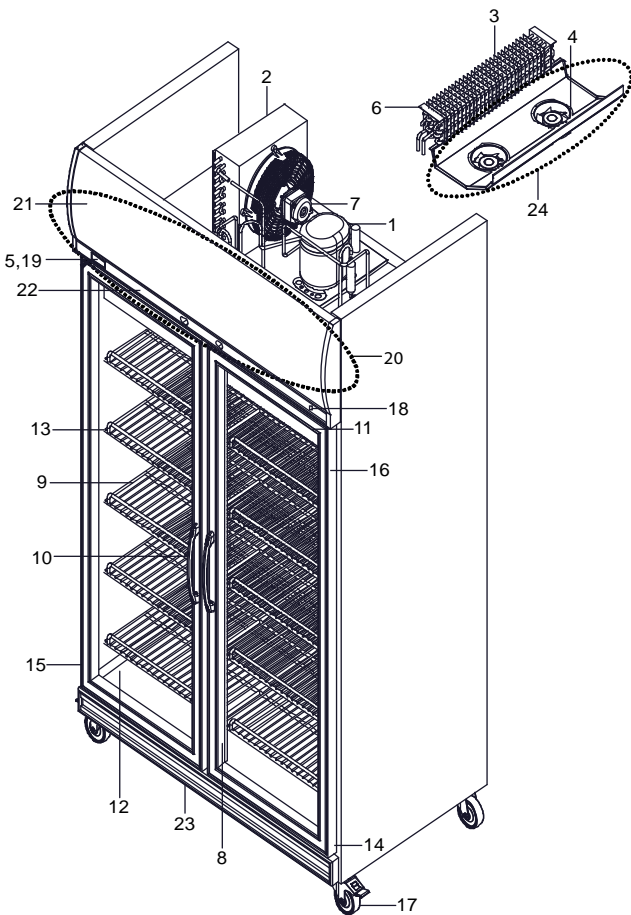









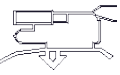

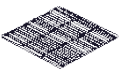

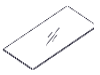

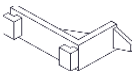

**WARNING** Warning: Do not use Electrical appliances inside the food storage compartments of the appliance, unless they are the type recommended by the manufacturer.

**PRODUCT TEMPERATURE REFERENCE**

Products	Temperature	Duration (Day)
Meat	-10°C till - 14°C (14°F - 6.8°F)	25
	-18°C (-0.4°F) and below	180

**EXPLOSIVE DRAWING**



 1 Compressor	 2 Condenser	 3 Cooling Coil	 4 A/C Cooling Fan
 5 Digital Thermometer - Dixell	 6 Deforst Heater	 7 Fan Motor	 8 Door Gasket
 9 Handle	 10 Shelving	 11 Flexible Drainage Heater	 12 Door Glass Only (Anti-Mist)
 12 Door - Complete Set - Gold	 12 Door - Complete Set - Silver	 13 Shelving Clips	 14 Door Spring
 15 Lower Fulcrum Bolt	 16 Door Hinges L & R	 17 Wheel	 18 Door Switch
 19 Digital Thermometer - Carel	 20 Light Box	 21 PVC Acrylic Sheet	 22 Display Freezer Digital Frame
 23 Display Down Panel C/B - Complete Set	 24 Fan Cover - Complete Set	 25 LED Lamp	

\*\* Light Box - no inclusive of lighting accessories and wiring \*\*

**COMPONENT LIST**

No	Parts		Model	UF0500LF	UF1000LF	UF1500LF
1	Compressor			(3/4HP)	(1.15HP)	(1.5HP)
2	Condenser			CD-075N-1	CD-125N	CD-125A
3	Cooling Coil			CC-16DF	CC-38DF	CC-38DF
4	A/C Fan			CS-AC8-P	CS-AC8-P	CS-AC8-P
5	Digital Thermometer - Dixell			TM-XR70CX-B	TM-XR70CX-B	TM-XR70CX-B
6	Defrost Heater			HT-DF19	HT-DF41	HT-DF41
7	Fan Motor			FE-VDE18W	FE-VDE10W	FE-VDE10W
8	Door Gasket			GS-562x1397DC (565mm X 1400mm)	GS-562x1397DC (565mm X 1400mm)	GS-562x1397DC (565mm X 1400mm)
9	Handle			HL-R001	HL-R001	HL-R001
10	Shelving			NT-DF-1D  (501mm X 475mm)	NT-DF-2/3D-S  (546mm X 475mm)	NT-DF2/3D-S (546mm X 475mm) NT-DF-3D-M (597mm X 475mm)
11	Flexible Drainage Heater			HT-WO	HT-WO	HT-WO
12	Door Glass Only (Anti-Mist)			GL-FZR (555mm X 1390mm)	GL-FZR (555mm X 1390mm)	GL-FZR (555mm X 1390mm)
	Door - Complete Set - Gold	Right		GLC-D-GDF-R	GLC-D-GDF-R	GLC-D-GDF-R
		Left		GLC-D-GDF-L	GLC-D-GDF-L	GLC-D-GDF-L
		Dimension		(603mm X 1438mm)	(603mm X 1438mm)	(603mm X 1438mm)
	Door - Complete Set - Silver	Right		GLC-D-SDF-R	GLC-D-SDF-R	GLC-D-SDF-R
		Left		GLC-D-SDF-L	GLC-D-SDF-L	GLC-D-SDF-L
Dimension			(603mm X 1438mm)	(603mm X 1438mm)	(603mm X 1438mm)	
13	Shelving Clip			HW-BSP 14W	HW-BSP 14W	HW-BSP 14W
14	Door Spring			DR-12	DR-12	DR-12
15	Lower Fulcrum Bolt			DR-04L-BOLT	DR-04L-BOLT	DR-04L-BOLT
16	Door Hinges	Right		DR-08HGRH	DR-08HGRH	DR-08HGRH
		Left		-	DR-07HGLH	DR-07HGLH
17	Wheel (Roda)	Swivel		WL-NS4	WL-NS4	WL-NS4
		Brake		WL-NB4	WL-NB4	WL-NB4
18	Door Switch			SW-E3101	SW-E3101	SW-E3101
19	Digital Thermometer - Carel			TM-IR33-FZR	TM-IR33-FZR	TM-IR33-FZR
20	Light Box	Gold		CS-PN-1F-LB-G	CS-PN-2F-LB-G	CS-PN-3F-LB-G
		Silver		CS-PN-1F-LB-S	CS-PN-2F-LB-S	CS-PN-3F-LB-S
		Black		CS-PN-1F-LB-B	CS-PN-2F-LB-B	CS-PN-3F-LB-B
21	PVC Acrylic Sheet			PVC-AS1D/D 625mm X 300mm	PVC-AS2D/D 1860mm X 300mm	PVC-AS3D/D 1250mm X 300mm
22	Display Freezer Digital Frame	Gold		OP-AP-1F-DF-G	OP-AP-2F-DF-G	OP-AP-3F-DF-G
		Silver		OP-AP-1F-DF-S	OP-AP-2F-DF-S	OP-AP-3F-DF-S
		Black		OP-AP-1F-DF-B	OP-AP-2F-DF-B	OP-AP-3F-DF-B
23	Display Down Panel C/B - Complete Set			CS-PN-D1D-DP	CS-PN-D2D-DP	CS-PN-D3D-DP
24	Fan Cover - Complete Set			CS-FC-8X1-CBF	CS-FC-8X2-CBF	CS-FC-8X2-CBF
25	LED Light			LE-LED-AC1200	LE-LED-AC1200	LE-LED-AC1200

## CIRCUIT DIAGRAM

### Digital Thermometer

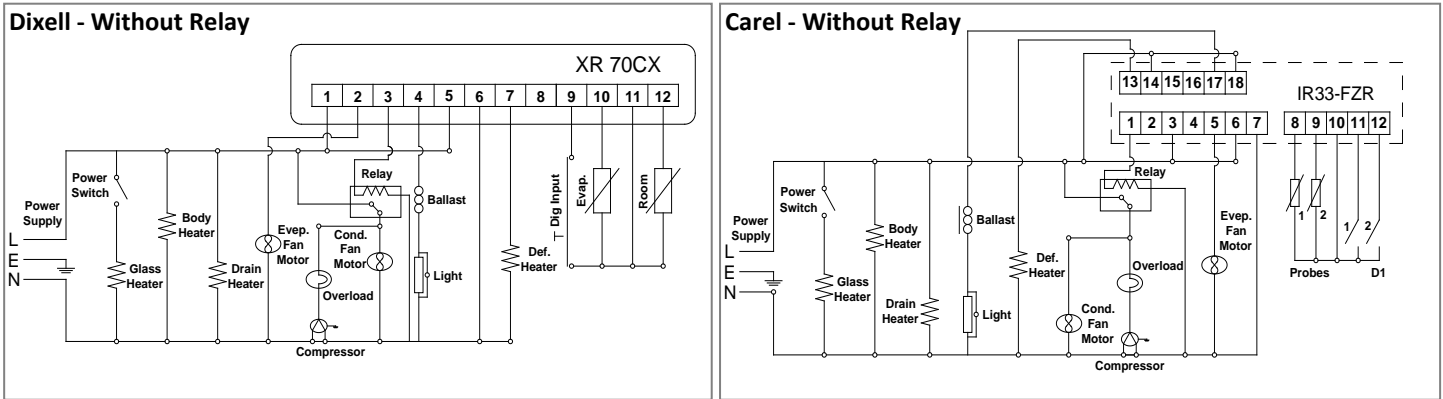

## FREEZER OPERATION

- 1- Switch on the power supply. The red light (\*) on. LED display is blinking for 60 sec with the unit's temperature.
- 2- After 1 minute, the light will be on, the compressor starts operating, and the digital controller displays the unit temperature.
- 3- The default parameter values are – 'Temperature Set point: -18°C', 'Differential: 4°C', 'Defrost Cycle: 4 Hours' and 'Defrost time: 20 Minutes'.

If user wants to alter these parameter values, please refer to the "XR70CX Instructions".

- 4- The compressor will stop running when the unit temperature downs to -18°C', and it will run again when the unit temperature rises to -14°C'. The compressor operates between -18°C'and -14°C'.
- 5- After the compressor operates 4 hours, (preset), defrost will take place and the red light  on, the heater also on.
- 6- The defrost timer is 20 minutes by electric heater. (Defrost time, the compressor stop, blower fan also stop). The compressor operates again after defrost.

## Replacement of LED Tube

- Unplug the unit before removal or replacing of LED Light
- Disconnect the power plug from the socket.
- Cut off the cable ties (if there are).
- Remove the fluorescent tube from the lamps holder.
- Remove the upper and lower holders.
- Remove the fluorescent tube cover.
- Reverse the sequence to reassemble it.
- The lamps have to be replaced by identical lamps only.

\* WARNING : - The replacement of lamp must be carried out only by a licensed service technician.\*

## MAINTENANCE

### Condenser Cleaning

- a- Condenser needs to be cleaned regularly. Before cleaning, unplug the unit and wait until the condenser is cooled.
- b- Use a compressed air jet or a non-metallic brush. Be careful not to damage the fins.

### Temporary Suspending Usage

- a- Attach a Styrofoam between the door and the body.
- b- Never put in a place where children are easily accessible. Children might get in and cannot get out!

### Unused For A Long Period

- a- Empty all goods and disconnect power.
- b- Keep door open to avoid mould and stinking.

**IMPORTANT INFORMATION FOR CORRECT DISPOSAL OF THE PRODUCT IN ACCORDANCE WITH EC DIRECTIVE 2002/96/EC**



At the end of its working life, the product must be not disposed of as urban waste. It must be taken to a special local authority differentiated waste collection centre or to a dealer providing this service. Disposing of a household appliance separately avoids possible negative consequences for the environment and health deriving from inappropriate disposal and enables the constituent materials to be recovered to obtain significant savings in energy and resources. As a reminder of the need to dispose of household appliances separately, the product is marked with a crossed-out wheeled dustbin.

**BEFORE CALLING FOR SERVICE**

Service calls can often be avoided! If you feel your refrigerator is not operating properly, check these possible causes first : -

<b>PROBLEM</b>	<b>POSSIBLE CAUSES</b>
Refrigerator Does Not Operate	<ul style="list-style-type: none"><li>- Has a fuse blown or circuit breaker tripped?</li><li>- Has the power cord plug been removed or loosed?</li></ul>
Under Achieve The Set Temperature Of The Unit	<ul style="list-style-type: none"><li>- The external temperature is too high, more external ventilation needed.</li><li>- The condenser is clogged by heavy oil stains &amp; dust, resulting in bad ventilation, cleaning needed.</li><li>- The door is not closed properly or some tiny gap occur between the door and body.</li><li>- Something blocks the ventilation passage accidentally.</li><li>- Too much food stuffed inside or too high the food temperature exceeds the cooling load.</li></ul>
Abnormal Noise	<ul style="list-style-type: none"><li>- Refrigerator is installed in a weak or uneven place or leveling screw needs adjusting.</li><li>- Unnecessary objects placed in the back side of the refrigerator.</li></ul>
Unit Has Odor	<ul style="list-style-type: none"><li>- Foods with strong odors should be tightly covered or wrapped.</li><li>- Interior needs cleaning.</li></ul>
De-Forms On The Cabinet Surface	<ul style="list-style-type: none"><li>- Not unusual during periods of high humidity.</li><li>- Door may have been left ajar.</li></ul>

**MEMO**

Please fill in the following at the purchasing time for future service reference.

Model Number :	
Purchasing Date :	
Dealer's Name :	
Address :	
Contact Number :	Home : Handphone :
Comment :	

The manufacturer reserves the right to change in design, equipment and technical features at any time. Accordingly, no claims based on data, illustration or descriptions in this operation manual will be admitted. English version is to be referred for any ambiguity.

This operation manual is for usage guideline. The technical data details and usage instructions are given with our best knowledge of product and with good faith. It should not bind the sales agent or manufacturer to attendance in court or to appear in any enquiry before any government or statutory bodies.