

INSTRUCTION MANUAL MEDICAL AND VACCINE FRIDGES

MED0140GD-NR



CONTENTS

1. PREFIX	3
2. IMPORTANT NOTES & WARNINGS	4
3. PRODUCT OVERVIEW	5
4. INSTALLATION	6
5. OPERATION	8
6. PRODUCT LOADING AND STORAGE	10
7. MAINTENANCE	11
8. TROUBLESHOOTING	12
9. SCHEMATIC DIAGRAM	13
10. ENVIRONMENTAL AND DISPOSAL NOTES	14
11. WARRANTY	15

1. PREFIX

This manual contains important information about the installation, operation, and maintenance of Bromic MediFridge™. Please pay close attention to the important safety information shown throughout this instruction manual. Any safety information will be accompanied by the following safety alert symbols:

 DANGER,  WARNING,  IMPORTANT

- READ THIS MANUAL CAREFULLY before installing or servicing this product.
- Improper installation, operation, or maintenance can result in death, severe injury, or property damage.
- This appliance is intended for 230-240 Volt power supply.
- Installation MUST be carried out by a licensed and authorised technician in accordance with local electrical codes.

2. IMPORTANT NOTES AND WARNINGS

- Read all instructions before installing or using this appliance
- Retain this manual for future reference
- Use this appliance only as described in this manual. Any other use not recommended by the manufacturer may cause fire, electric shock or injury to persons.
- Improper installation, adjustment or alteration and failure to follow the warnings and instructions in this manual could result in severe personal injury, death or property damage
- The manufacturer is not responsible for any damage that could happen from improper use. The manufacturer emphasises that this appliance should be used in a responsible manner and that all procedures, warnings, and safety instructions contained in this booklet be followed strictly.
- Check the appliance for damage. Do not operate a damaged unit.
- Check for damage to the appliance regularly. If damage to the appliance is suspected, discontinue use immediately and contact the supplier or qualified person to repair.
- This appliance is not intended for use by persons (including children) with reduced physical, sensory or mental capabilities, or lack of experience and knowledge, unless they have been given supervision or instruction concerning use of the appliance by a person responsible of their safety.
- Keep packaging material out reach of children
- Children should be carefully supervised to ensure that they do not play with the appliance
- Do not attempt to alter the appliance in any manner.
- Please pay attention to the maximum load limit when filling the shelves.
- All work on electrical equipment must be carried out by a qualified and licensed technician only.
- Do not perform maintenance until the appliance has been turned off and power disconnected.
- Never detach any cover except where specifically instructed in this manual. Doing so might expose live electrical parts.
- Do not operate the appliance with panels, covers or guards removed.
- Keep the air intake and outlets free of obstructions.
- Do not use the appliance outdoors.
- If the supply cord becomes damaged, it must be replaced by an authorised service agent or similarly qualified person in order to avoid a hazard.
- If the appliance has not been used, or will not be used for a long period of time, disconnect power supply.
- Ensure the appliance has adequate ventilation.
- The top of the cabinet should not be used for the storage of any objects and must be clean and dry at all times.



**Caution
Risk of fire**

3. PRODUCT OVERVIEW

MED0140GD-NR			
Part Number		3736257	
External Dimension	Height, mm	820	
	Width, mm	595	
	Depth, mm	595	
Capacity	Litres	225	
Weight	Kg	40	
Temperature	Range	+2°C to +8°C	
	Type	Digital	
Ambient Temperature	Type	32°C	
Climate Class	Rating	4M2	
Energy Consumption	kWh/24h	1.396kWh/24h	
Refrigerant	Refrigerant	R600a	
	Charge, g	100W	
Air Circulation		Fan Forced	
Current		1.2A	
Electrical Voltage		220-240V	
Frequency	Hz	50	
Plug Location		Rear, bottom right	
Colour	Default	White	
Internal Light	Type	LED	
Number of Doors	Quantity	1	
	Type	Glass	
	Glass Type	Double glazed Low-E Glass + Argon Gas	
	Style	Hinged	
	Lock	Yes	
	Self Closing	Yes	
Door	Shape	Flat	
	Door Swing Dimensions	mm	590
	Total Depth of Door Open	mm	1990
	Number of Shelves incl. base per Door	Quantity	4
	Shelf Dimensions	mm	500(w) x 355(d) mm
	Temp, Door, Audible & Visual Alarm	Y/N	Yes

4. INSTALLATION



NOTE: The maximum ambient temperature for the refrigerator is 30°C. Conditions outside this temperature will result in cabinet temperatures outside the required 2 to 8°C range. Bromic recommends that the refrigerator is installed at an ambient temperature of 20 to 25°C.

Locating the Cabinet

Ensure the following instructions are observed as this is vital for proper and trouble-free operation.

- Do not install the cabinet outdoors.
- Locate the appliance in a dry and well ventilated place.
- The unit must be positioned on a level surface.
- Do not install in the vicinity of heating radiators or other heat sources.
- Do not install the appliance where it is exposed to direct sunlight.
- Do not install the appliance where it is exposed to warm draughts or open doors.
- Keep the air intake and outlets free of obstructions.
- Adequate allowance should be made for door openings.

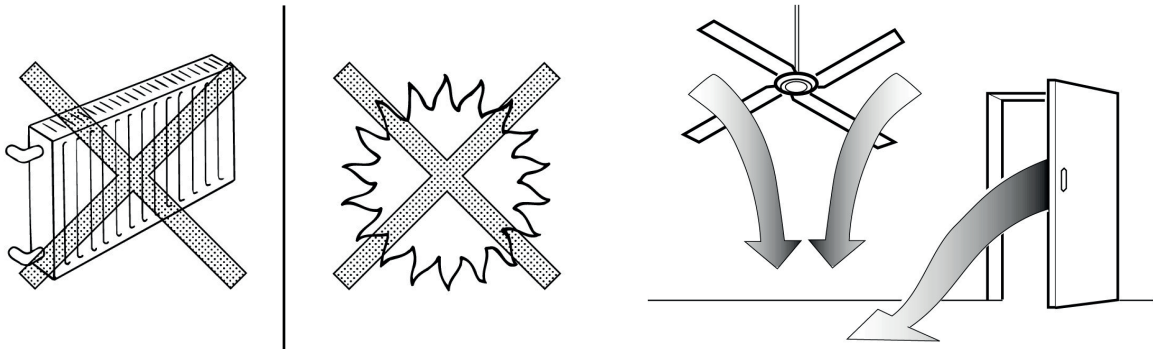

Ventilation

Ensure the following instructions are observed as this is vital for proper and trouble-free operation.

- Allow 100mm clearance between walls and the appliance.
- Ensure that the condenser fan is free to take in ambient air from the room.
- Adherence to minimum clearances is necessary

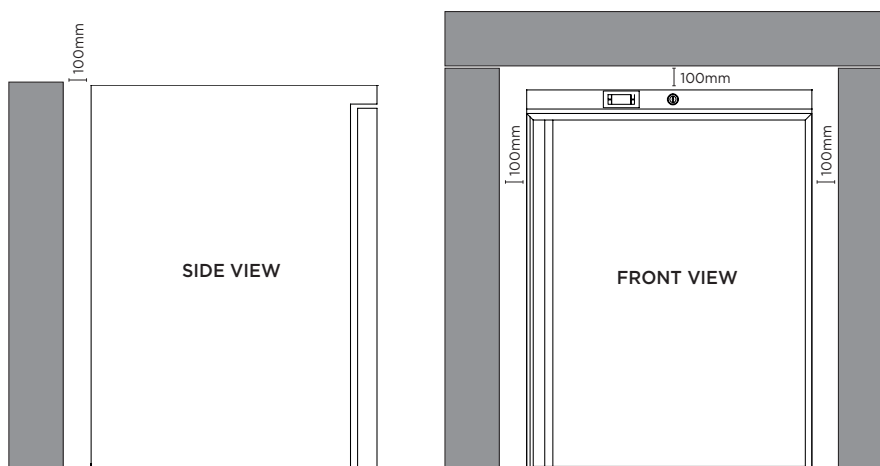

Power Supply

- The appliance must not be plugged into a multiple outlet power board.
- The appliance is supplied with a flexible power cord fitted with a 3-pin plug.
- The socket used must be properly earthed and fuse protected.
- See the rating label inside the cabinet for supply voltage, frequency and current draw.
- Power cable is rated 70°C. It is recommended that the cable should not come into contact with parts over 50°C.
- Do not turn off power before consulting the person responsible.
- Mark the power source clearly, so the refrigerator is not unplugged or turned off accidentally.

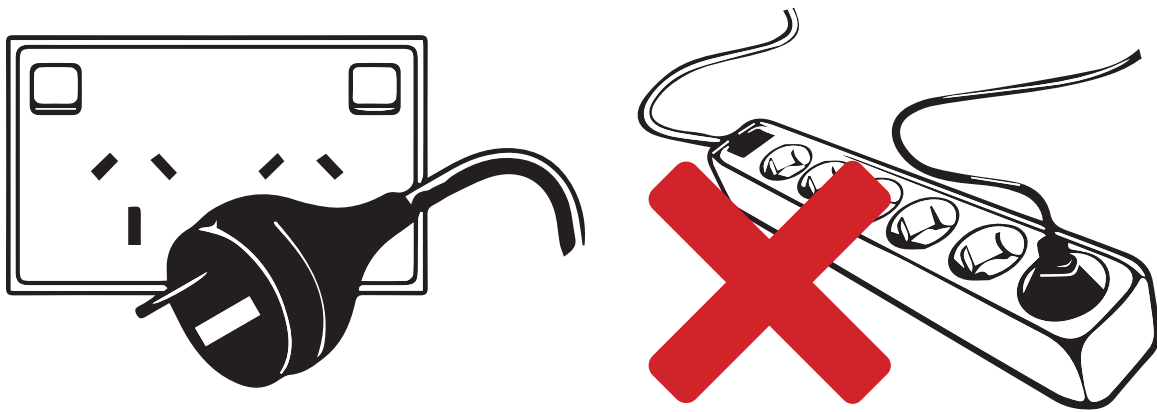

Before Operating

- If the appliance has been sharply tilted or transported in the horizontal position, it must be left to stand in the upright position and not plugged in for 1 hour.
- Remove all the packaging material before using the appliance.
- Start the appliance only if it has been installed as described.

5. OPERATION

Start-up

- Connect the appliance to the mains power supply and check that the compressor, electronic controller, lighting and all fans are functioning correctly.
- The compressor and condenser fan should operate should operate 3 minutes after the unit has been connected to the power supply.
- The evaporator fan should operate after the unit has been plugged in.
- The electronic controller will display the current cabinet temperature after the unit has been connected to the power supply.
- The ❄️ LED indicates that refrigeration circuit is operating.
- During the start-up delay (3 minutes), the ❄️ LED is flashing
- The ❄️ LED indicates that the refrigeration circuit is defrosting

Setting the temperature

NOTE: The controller is factory set at 4°C. The controller is programmed to control cabinet temperatures between 2 to 8°C.

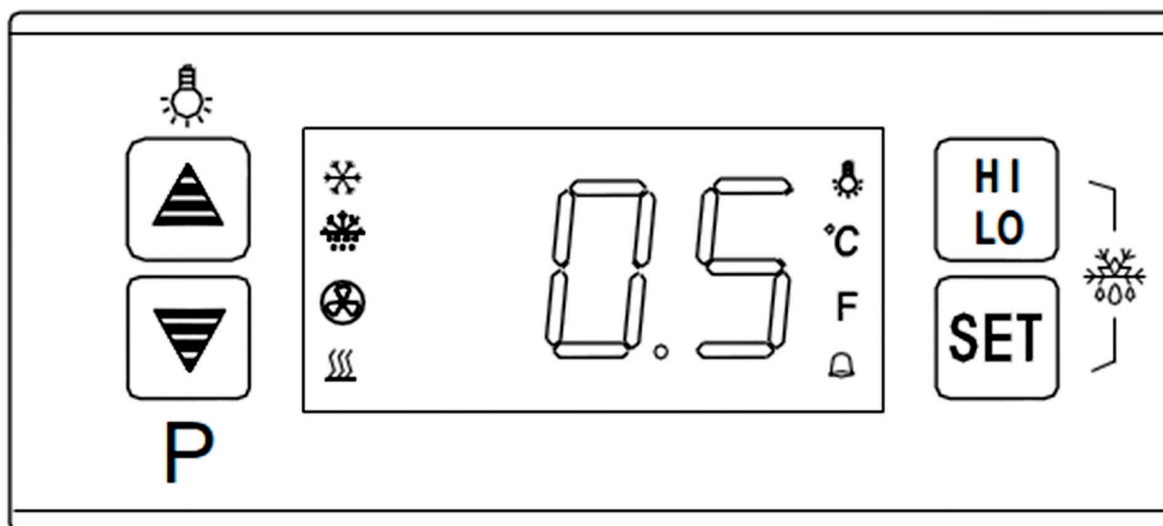

- Press the **SET** button.
- The set temperature will be displayed.
- Press **▲** or **▼** to adjust the temperature.
- Press the **SET** button to exit. If no further buttons are pressed within 6 seconds, the cabinet temperature will be displayed.

Display the Product Sensor Temperature

- Press the **▼** button.
- The product temperature will flash and display.
- After 6 seconds, the cabinet temperature will be displayed.



Operating the Light

- Press the **▲** button to turn internal LED lights ON or OFF

MAX / MIN Temperature Recording



IMPORTANT: Record the maximum and minimum temperatures two (2) times a day. Recordings should be taken before the first door opening of the day.

- i. Press the  button once
- ii. The highest temperature recording will be displayed.
- iii. Press the  button again while the highest temperature recording is displayed.
- iv. The lowest temperature recording will be displayed.
- v. To clear the MAX/MIN recording – Hold the  button for 6 seconds
- vi. The display will flash for 3 seconds and the buzzer will sound – this will clear the previous highest and lowest temperature recording.
- vii. The current cabinet temperature will be recorded.

Controller Alarms

If alarms persist, contact the manufacturer or an approved service agent.

Code	Alarm Type	Corrective Action
HI	Cabinet high temperature alarm	<ul style="list-style-type: none"> • Check if there is adequate ventilation • Check if there is free circulation of air inside the cabinet • Check and clean condenser coil and fan • Check if door is shut
LO	Cabinet low temperature alarm	
1H	Cabinet temperature sensor short circuit	<ul style="list-style-type: none"> • Unplug the unit for 1 minute then reconnect to power
1L	Cabinet temperature sensor open circuit	
2H	Product temperature sensor short circuit	
2L	Product temperature open circuit	
H2	Product high temperature alarm	<ul style="list-style-type: none"> • Check if there is adequate ventilation • Check if there is free circulation of air inside the cabinet • Check and clean condenser coil and fan • Check if door is shut
dR	Door open alarm	<ul style="list-style-type: none"> • Close the door

6. PRODUCT LOADING AND STORAGE



WARNING: Failure to follow the guidelines below will result in cabinet temperatures above 8°C

IMPORTANT: Run the refrigerator for at least 2 hours before loading.

Start-up

- Clean the interior surface with a soft cloth and warm water before loading.
- Ensure there is free circulation of air between the products.
- Do not block the evaporator fan.
- Do not overstock the refrigerator.
- Use cold mass (i.e. water bottle) on unused shelves.
- Keep refrigerator door openings to a minimum.
- Ensure products are between 2 and 8°C before loading – if there is a breach in the cold-chain, isolate the affected products. Do not use or discard until advise is given.
- Some products are sensitive to ultraviolet (UV) light, please see storage guidelines from the manufacturer before removing from packaging.
- Do not store food and other goods in the refrigerator.
- Maximum recommended shelf load is 20kg.

NOTE: Bromic cannot be responsible for loss of stock or damage to stock.

Please refer to the 'National Vaccine Storage Guidelines: Strive for 5' for more information on vaccine storage and handling or contact your local state or territory health department.

(<http://www.health.gov.au/internet/immunise/publishing.nsf/content/IMM77-cnt>)

7. MAINTENANCE



WARNING: Disconnect the appliance from the power supply before performing any maintenance. Never unplug the appliance by pulling on the cord. Always grasp the plug firmly and pull straight out of the outlet.

WARNING: Exposure to significant water ingress will void warranty and cause potential safety issues. If the unit should be exposed to water, please contact the manufacturer immediately.

IMPORTANT: Warranty may be void if there is no evidence of preventative maintenance is performed on the appliance.

Cleaning the Cabinet

- Remove the products and transfer to a suitable location prior to cleaning the inside of the cabinet.
- Do not use any aggressive or abrasive cleaning agents.
- Never use a water hose or a high-pressure jet to clean.
- Do not use sharp or pointed objects for cleaning.
- Clean the inside and outside of the appliance with a clean damp cloth or with a neutral cleanser.
- Dry all surfaces with a dry cloth.

Condenser Coil



IMPORTANT: The condenser coil must be cleaned with a vacuum or brush once a month. The condenser coil must be cleaned regularly to maintain the performance and minimise power consumption. A poorly maintained condenser coil can lead to failure of the unit and cabinet temperatures above 8°C.

Extended Defrosting

The evaporator (cooling) coil of the refrigerator may build up a layer of ice over time. This will reduce the performance of the unit – inspect the evaporator coil for ice build-up regularly. For extended defrosting, turn off the unit with the door opened for a period of 24 hours.

8. TROUBLESHOOTING



IMPORTANT: Repairs on the unit must be carried out by an authorised and licensed person only. Contact the manufacturer or an approved service agent for any repairs needed.

Symptom	Possible Cause(s)	
Unit does not work	A. No power supply	A. Check power supply
Cabinet Temperature Too High	A. Ambient temperature too high B. Inadequate ventilation C. Wall clearances below minimum distance D. Dirty condenser coil E. Ice build-up on evaporator coil	A. Relocate unit B. Keep ventilation slots free C. Adjust to minimum clearance D. Clean E. Perform extended defrosting
Cabinet Temperature Too Low	A. Set temperature too low	A. Adjust set temperature
Cabinet lights not working	A. Light not switched on B. Light is faulty	A. Switch on B. Replace light
Drip tray overflowing	A. Extreme operating condition	A. Relocate unit
Odour inside cabinet	A. Cabinet dirty	A. Clean

9. SCHEMATIC DIAGRAM

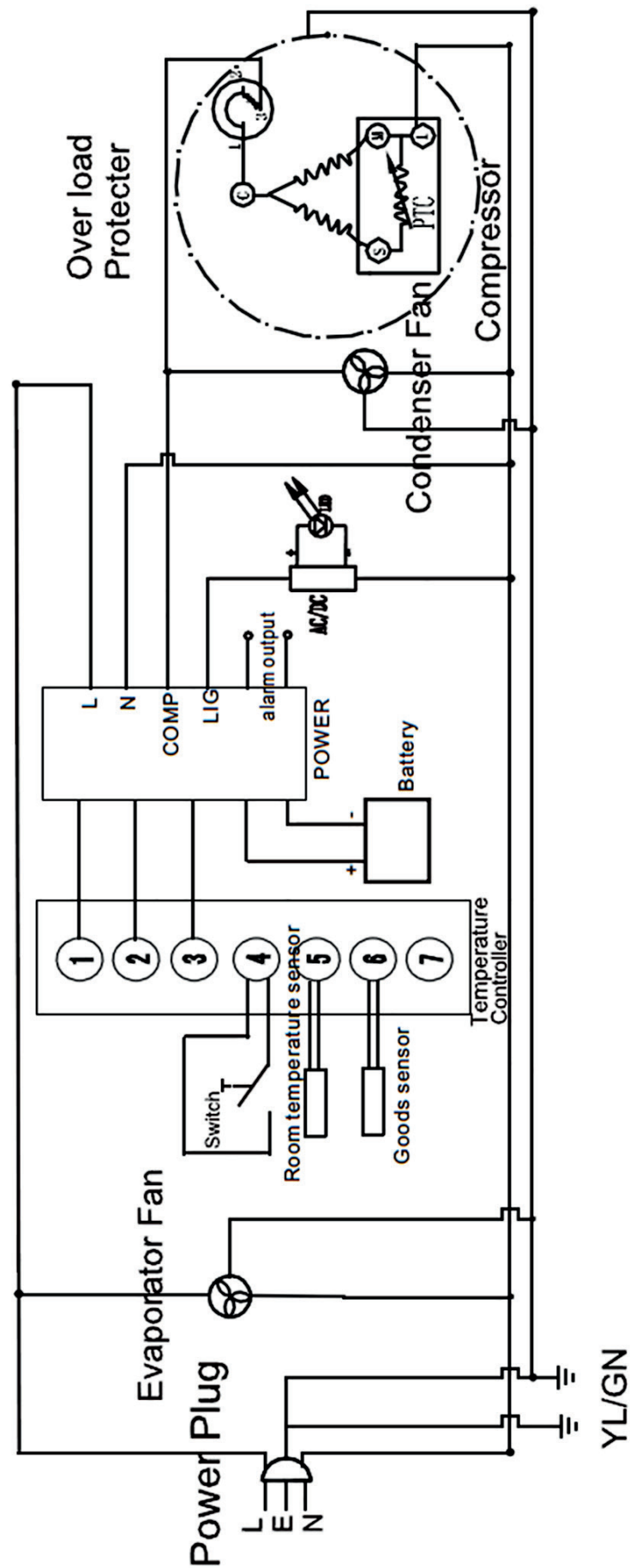

10. ENVIRONMENTAL AND DISPOSAL NOTES

These refrigerated cabinets are designed to high standards of environmental protection and recycling convenience. Cyclopentane, an environmentally friendly foaming agent, has been used. Cyclopentane is distinguished by zero ozone depletion potential (ODP) and zero global warming potential (GWP). The refrigerant used and contained within a hermetically tight circuit is environmentally friendly and does not contain chlorine and zero ODP.

The device must be disposed of in accordance with applicable regulations. The WEEE regulations must be observed.

In the interest of preventing environmental nuisance and promoting re-use of the high quality materials employed, used commercial refrigeration equipment must be collected for expert disposal and recycling. Therefore, observe the following disposal regulations:

- The cabinet must not be discarded with regular waste.
- The refrigeration circuit must not be damaged.
- Before disposal, make it unserviceable by disconnecting the power plug and cutting off the power cable.
- Consult your local authorities or authorised dealers for details of collection and disposal facilities.
- Children are often unable to recognise the dangers associated with commercial refrigeration equipment. Proper supervision must be maintained and children must be prevented from playing with discarded refrigerated cabinets.

12. WARRANTY







All Bromic products are manufactured to the highest quality standard and are supported by our Extra Care Service Warranty, including guarantees against any material or workmanship defects; guarantees that cannot be excluded under Australian Consumer Law.





Warranty Terms vary across the range. Please ensure you are familiar with the Terms and Conditions that apply to the purchase of your Bromic product by referring to the Warranty Policy included with your purchased product.

Alternatively, you can also download the Warranty Policy at <https://bromicrefrigeration.com.au/extra-care-warranty>

HOW TO PLACE A SERVICE REQUEST

- Please call 1300 276 642 to place a warranty service request and let the operator know whether you need Priority A or B service. More information can be found below.
- Ensure you have the serial number of your product ready before contacting us.
- The serial number of your product can be found on a compliance plate located on the inside right and at the rear of your cabinet.

P/N#3735161-NR				
Serial number:		Model:		
		UC0650SD-NR		
ST21113A01GH65T004		Digital Thermostat Ventilated		
Description		Power:		
CHILLER UC0650SD-NR		AC220-240V 50Hz 1Ph		
UPRIGHT 1DR 650L S/S		MADE IN CHINA		

BROMIC REFRIGERATION				
Serial no. :		ST21113A01GH65T004		
Climatic classification:		4		Insulation Blowing Gas
Bromic Model:		UC0650SD-NR		C5H10
Bromic Part no. :		3735161-NR		
Refrigerant type:		R290		
Rated Voltage:		AC220~240V		
Rated current:		3.0A		
Net Weight:		135Kg		
Rated Wattage:		305W		
Max Lamp Wattage:		1.5W		
		g	120	
		Hz	50	
				
		MADE IN CHINA		

Compliance Plate Example 1

SERVICE REQUEST PRIORITY



PRIORITY A SERVICE

When the unit is **NOT** performing its primary function such as cooling or heating, or presents an OH&S or food safety risk



PRIORITY B SERVICE

When the unit is performing its primary function, and presents no OH&S or food safety risk. i.e. lights, gaskets, locks, door adjustment



SERVICE CALL PLACED BEFORE MIDDAY

Priority A - Technician to attend site within 4 hours
Priority B - Technician to attend site within 8 business hours



SERVICE CALL PLACED AFTER MIDDAY

Priority A - Technician attends site before midday on the following business day
Priority B - Technician attends site before 4pm on the following business day



BROMIC REFRIGERATION

10 Phiney Place, Ingleburn (Sydney)
NSW 2565 Australia
T. 1300 276 642

For further product information
bromicrefrigeration.com.au