



## WAREWASHING



## Glasswashers PROFI GC

## Installation and Operation Instructions

*(Translation of the original operating  
instructions)*

EN

DSN: GC-13-01  
Start SN: 86 61 03001

7. Oct. 2016

**Publisher**

HOBART GmbH  
Robert-Bosch-Str. 17  
77656 Offenburg  
Tel. +49(0)781 600 0  
Fax +49(0)781 600 23 19  
E-mail: [info@hobart.de](mailto:info@hobart.de)  
Internet: [www.hobart.de](http://www.hobart.de)

**Product disclaimer**

Installations and repairs carried out by non-authorized technicians or using non-genuine spare parts, and any technical alterations to the machine not approved by the manufacturer will invalidate the manufacturer's warranty and product liability.

HOBART reserves the right to make changes or improvements to its products without prior notice.

© HOBART GmbH, Offenburg 2016

---

## Table of Contents

<b>1</b>	<b>Notes on the documentation</b> .....	5
1.1	Application .....	5
1.2	Layout of the documentation .....	5
1.3	Representation convention .....	5
<b>2</b>	<b>Safety instructions and regulations</b> .....	7
2.1	Safety instructions and warning notices .....	7
2.2	Basic safety instructions .....	7
2.3	Property damage .....	9
<b>3</b>	<b>Product description</b> .....	10
3.1	Intended purpose .....	10
3.2	Designation .....	10
3.3	Technical specifications .....	10
3.4	Conformity .....	11
<b>4</b>	<b>Controls</b> .....	12
4.1	Controls .....	12
4.2	Operating states .....	12
4.3	Display of faults and information .....	13
4.4	Display function .....	13
4.5	Overview of main menus .....	14
4.6	Overview of display symbols .....	14
<b>5</b>	<b>Installation</b> .....	16
5.1	Personnel qualification .....	16
5.2	Special safety instructions .....	16
5.3	Transporting to the installation location .....	16
5.4	Removing the packaging .....	17
5.5	Installing the machine .....	17
5.6	Connecting to the power supply .....	18
5.7	Connecting the water .....	18
5.8	Connecting the drain .....	19
5.9	Retrofitting integrated chemical container (optional) .....	19
<b>6</b>	<b>Commissioning</b> .....	20
6.1	Personnel qualification .....	20
6.2	Starting the commissioning procedure .....	20
6.3	Setting the language .....	20
6.4	Setting the date .....	20
6.5	Setting the time .....	20
6.6	Select reverse osmosis .....	21

## Table of Contents

6.7	Setting the water hardness (optional) .....	21
6.8	Filling the salt reservoir (optional).....	21
6.9	Filling the chemical container and chemical hoses.....	22
6.10	Completing the commissioning procedure .....	23
<b>7</b>	<b>Operation</b> .....	<b>24</b>
7.1	Personnel qualification.....	24
7.2	Special safety instructions .....	24
7.3	Notes for optimum washing result.....	24
7.4	Preparations for washing .....	25
7.5	Displaying and selecting the program .....	26
7.6	Washing .....	27
7.7	Switch off machine .....	27
7.8	Executing daily cleaning .....	27
7.9	Executing weekly cleaning .....	28
7.10	Executing hygiene cleaning .....	28
7.11	Executing the basic cleaning program for washware.....	28
7.12	Executing the descaling program .....	29
7.13	Displaying the temperatures.....	30
<b>8</b>	<b>Setting options, operating and hygiene data</b> .....	<b>31</b>
8.1	Overview of operator menu .....	31
8.2	Opening the operator menu .....	31
8.3	Navigating, selecting and setting within the menu .....	32
8.4	Exiting the operator menu.....	32
8.5	Making the general settings .....	33
8.6	Setting the display indications .....	33
8.7	Setting the acoustic signal .....	33
8.8	Making the chemical settings.....	34
8.9	Configuring the counter for external water treatment (optional) .....	34
8.10	Setting the water hardness (optional) .....	35
8.11	Displaying the operating/hygiene data.....	35
8.12	Setting automatic switch-on .....	37
<b>9</b>	<b>Fault indications and problems</b> .....	<b>39</b>
9.1	Fault indications .....	39
9.2	Remedying the problem .....	41
<b>10</b>	<b>Maintenance</b> .....	<b>43</b>
<b>11</b>	<b>Disposal</b> .....	<b>44</b>

# 1 Notes on the documentation

## 1.1 Application

This document contains the most important information for the installation and commissioning of the machine by qualified personnel, as well as the information required for day-to-day operation by the operator.

- ▶ Keep the operating instructions and all referenced documents in a safe and accessible place.
- ▶ If you sell the machine, pass on the installation and operating instructions.

## 1.2 Layout of the documentation

Referenced documents are all instructions that describe the installation, operation, maintenance and repair of the device, as well as additional instructions for all accessories used.

### For the operator:



- Comic Card (brief instructions)
- Operating instructions

### For the specialised tradesman:







- Installation instructions
- Service Manual
- Service Software Manual
- Trouble shooting list
- Circuit diagram
- Spare parts catalogue

## 1.3 Representation convention

### 1.3.1 Symbols used

Symbol	Meaning
	Warning of hazardous electrical voltage
	Beware of explosion

## Notes on the documentation

Symbol	Meaning
	Warning of risk of crushing
	Beware of hazardous substances
	Beware of hand injuries
	Beware of slipping
	Beware of hazard area
	Useful additional information and tips

## 1.3.2 Representation in the text

Representa- tion	Meaning
<b>NOTE</b>	Important information on machine operation, not a warning notice
▶	Step
↳	Outcome/result
–	Listing 1st level
•	Listing 2nd level





## 2 Safety instructions and regulations

### 2.1 Safety instructions and warning notices

- ▶ During machine operation, observe the general safety instructions and warning notices that precede each action.

#### 2.1.1 Hazard levels

The hazard level is part of the safety instructions and is denoted by the signal word. Potential consequences are differentiated by the choice of signal word.

 <b>DANGER</b>	imminent danger: <b>results in serious</b> physical injury or death
 <b>WARNING</b>	potentially hazardous situation: <b>can cause serious</b> physical injury or death
 <b>CAUTION</b>	potentially hazardous situation: <b>can cause minor</b> physical injury
 <b>NOTICE</b>	potentially harmful situation: <b>can cause damage</b> to the product or other objects

#### 2.1.2 Layout of warning notices

Warning notices are depicted with warning symbols and signal word in the corresponding safety colours.



**Nature and source of the hazard**

Explanation on the nature and source of the hazard

- ▶ Measures for averting the hazard
- ▶ additional measures for averting the hazard, where applicable

### 2.2 Basic safety instructions

#### 2.2.1 Product safety

The machine conforms to state-of-the-art technology and the recognised safety regulations. Nonetheless, hazards may occur.

## Safety instructions and regulations

Operate the machine only in compliance with the operation manual.

All modifications and alterations to the product are reserved for persons authorised by HOBART.

### 2.2.2 Personnel qualification

- ▶ Observe the regulations on occupational health and safety.
- ▶ Carefully read through the installation and operation instructions before use.

Activity	User group	Qualification/training
Installation/commissioning	Qualified personnel	Authorised electrician (qualified electrician or persons who have undergone equivalent training)
	Trainees	Only under appropriate supervision and inspection
Work on the electrical system	Qualified personnel	Qualified electrician
Operation	Laymen/disabled persons	Training by the operator using the operating instructions, hazard briefing
	Persons from 14 years old	Training by the operator using the operating instructions, hazard briefing, only under supervision
	Persons up to 14 years old	Not permitted
Maintenance, repair	Qualified personnel	Hobart Service or Hobart trained service technicians
	Trainees	Only under appropriate supervision and inspection

### 2.2.3 Product-specific hazards

***Avoid body parts being crushed or knocked:***

- ▶ Observe the instructions on the packaging for storage, lifting or transporting.

***Avoid risk of explosion:***

- ▶ Do not install machine in a potentially-explosive location.

***Avoid electric shock, fire risk:***

- ▶ Do not allow water to flow under live components.
  - Make sure the machine is correctly stored (see frost damage section 2.3).
  - Make sure that the machine does not overflow when being filled.
- ▶ Do not damage the connection cable while unpacking.
- ▶ Have the machine connected to the power supply by qualified personnel.
- ▶ Have all modifications to the machine carried out by qualified personnel.
- ▶ Have additional feed tanks mounted by qualified personnel.



## Safety instructions and regulations

---

- ▶ Do not operate the machine unsupervised.

### ***Avoid chemical burns, sensitisation of the skin, poisoning:***

- ▶ Wear protective equipment (gloves, safety goggles, protective clothing) when handling chemicals.
- ▶ Use only suitable chemicals. Observe the manufacturer's data.
- ▶ Chemiesensorik nur durch autorisierte geschulte Servicetechniker einstellen lassen.
- ▶ Do not open the machine during operation, wait for the program to finish.
- ▶ Disconnect the machine from the mains prior to cleaning.
- ▶ For cleaning, wear protective equipment (gloves, safety goggles, protective clothing) when touching parts contaminated by detergent.

### ***Avoid burns, scalds (to the hands):***

- ▶ Do not open the machine during operation or the evaporation phase, wait for the programme to finish.  
Otherwise, hot water could spray out.
- ▶ Disconnect the machine from the mains prior to cleaning.

### ***Avoid slipping:***

- ✓ Moisture can build up on the machine floor.
- ▶ Provide a floor covering that is guaranteed to be non-slip in case of moisture.

### ***Residues on the washware, hygiene regulations not maintained.***

- ▶ Hygiene regulations must be maintained and/or demonstrated in accordance with the national provisions.

## 2.2.4 Additional hazards

---

Potential hazards caused by operating resources to be used can be found in the enclosed safety datasheets. Workplaces must be signed accordingly.

## 2.3 Property damage

---

### ***Avoid frost damage:***

- ✓ Temperatures below 0°C during transport/storage cause function impairments.
- ▶ Prior to installation, store the machine at room temperature (min. 15°C) for 24h.

### ***Avoid water damage:***

- ▶ Do not operate the machine unsupervised.
- ▶ Close site shut-off valves at the end of operation.

### 3 Product description

#### 3.1 Intended purpose

The machine is an item of technical equipment intended solely for commercial dishwashing.

The machine is designed solely for cleaning crockery (porcelain, glass, ceramic, temperature-resistant plastics or stainless steel or similar) from the food industry.

Not for washing:

- Containers that do not come into contact with foodstuffs, such as ashtrays, candlesticks, electric appliances etc.
- Animals or textiles
- Foodstuffs intended for further consumption

#### 3.2 Designation

The rating plate is located on the front of the machine. If you have any questions regarding service and parts, quote the serial and DSN No.

#### 3.3 Technical specifications

Dimensions (H x W x D)	700 x 460 x 590 mm
Water consumption per rinse cycle	1.9 l
Line flow pressure	0.5 – 10 bar min. 0.8 bar with integrated softener
Cold or hot water connection	max. 60°C
Voltage	see rating plate
Total connected load	
Fuse protection	
Tank capacity	8 l
Rack height	315 mm
Emission sound pressure level $L_{pA}$ (Measurement uncertainty $k_{pA} = 2.5$ dB)	62 dB (A) for under-counter machine
Weight	50 kg

### 3.4 Conformity



Original

#### Konformitätserklärung

Declaration of Conformity / Déclaration de Conformité / Declaración de Conformidad / Dichiarazione di conformità / Conformanceverklaring / Deklaracja zgodności / Декларация соответствия / Uygunluk beyanı / Deklaracija o skladnosti / Izjava o skladnosti / Declaração de Conformidade / Prohlášení o shodě

#### Hersteller / Dokumentationsbevollmächtigter:

Manufacturer / authorized to compile the technical file:  
Fabricant / autorisé à constituer le dossier technique:  
Fabricante / autorizado para unificar la información técnica:  
Fabbricante / Responsabile della documentazione:  
Fabrikant / Geautoriseerd om de technische documentatie samen te stellen:  
Producent / autoryzowany przedstawiciel:  
Изготовитель / ответственный за составление документации:  
Üretici / Dokümantasyon yetkilisi:  
Proizvođač / ovlašten za sastavljanje tehničkog spisa:  
Proizvajalec / pooblaščen za dokumentacijo:  
Fabricante / Responsável pela documentação:  
Výrobce / osoba zplnomocněná sestavením dokumentace:

#### HOBART GMBH / Ruediger Nuebling

Robert-Bosch-Straße 17  
77656 Offenburg / Germany

**Maschine:** Gläserpülmaschine  
Machine: Glasswasher  
Machine: Lave verres  
Máquina: Lavavasos  
Macchina: Lavabicchieri  
Machine: Glazewasmachine  
Urządzenie: Zmywarka do naczyń ze szkła  
Машина: Стаканомоечная машина  
Makine: Bardak yıkama  
Stroj: Perilica čaša  
Stroj: Stroj za pomivanje kozarcev  
Máquina: Máquina lava-copos  
Stroj: Myčka na sklenice

#### Marke: HOBART

Trade mark/ Marque/  
Marca comercial/ Marchio/ Merk/  
Marka/ Марка/ Marca/ Zaštitni  
znak/ Znamka / Marca/ Značka

**Type:** GC-Serie  
GCP-Serie **Design State:** GC-13-01 **Serial No.:** 86 61 XXXXX

#### Hermit bestätigen wir, dass die genannte Maschine entsprechend den nachfolgend aufgeführten Normen gefertigt und geprüft worden ist.

Herewith our confirmation that the named machine has been manufactured and tested in accordance to the following standards.  
Par la présente, nous déclarons que la machine citée ci-dessus a été fabriquée et testée en conformité aux normes.  
Por la siguiente confirmamos que la máquina mencionada ha sido fabricada conforme a las siguientes normas.  
Con la presente confermiamo che la macchina indicata è stata costruita in conformità alle norme di seguito riportate.  
Hierbij bevestigen wij dat de genoemde machine is gefabriceerd en getest volgens de hiervolgende voorwaarden.  
Niniejszym deklarujemy, że wymieniony produkt spełnia wymogi następujących norm.  
Настоящим мы подтверждаем, что указанная машина изготовлена в соответствии с приведенными ниже нормами.  
İşbu belge ile belirlenen makinenin aşağıda listelenen normlar doğrultusunda hazırladığımız beyan ederiz.  
Ovime potvrdujemo da je gore navedeni stroj proizveden i testiran sukladno sljedećim standardima.  
S tem izjavljamo, da je naveden stroj izdelan in preizkušen v skladu s spodaj navedenimi standardi.  
Com a presente declaramos que a máquina supracitada foi construída e inspecionada segundo as normas referidas a seguir.  
Tímto potvrzujeme, že uvedený stroj byl vyroben a zkontrolován podle následujících norem.

EN 60335-2-58:2005 + Corr. 2007 + A1:2008 + A11:2010  
EN ISO 12100:2010  
EN 55014-1:2006 + A1:2009 + A2:2011  
EN 61000-3-2:2014  
EN 61000-3-3:2013  
EN 55014-2:2015  
DIN SPEC 10534:2012-08

#### Die Maschine stimmt mit den folgenden Richtlinien überein:

The product complies with the following directives:  
La machine est conforme aux directives fixées:  
La máquina armoniza con las siguientes Directivas:  
La macchina è conforme alle direttive seguenti:  
Het product voldoet aan de volgende richtlijnen:  
Urządzenie spełnia wymogi następujących dyrektyw:  
Машина соответствует требованиям следующих директив:  
Makine, aşağıdaki yönetmelikler ile uyumludur:  
Ovaj stroj je u skladu sa sljedećim direktivama:  
Stroj ustreza zahtevam sledećih direktiv:  
A máquina está em conformidade com as seguintes diretivas:  
Stroj je v souladu s ustanoveními následujících směrnic:

2006/42/EC (Maschinenrichtlinie, Machinery-Directive)  
2014/30/EU (EMV-Richtlinie, EMC-Directive)

#### Die Schutzziele der Niederspannungsrichtlinie 2014/35/EU wurden gemäß Anhang I Nr. 1.5.1 der Maschinenrichtlinie 2006/42/EC eingehalten.

Protective Goals of the Low Voltage Directive 2014/35/EU are in compliance with Appendix I No 1.5.1 of the Machinery Directive 2006/42/EC.  
Les objectifs de protection de la directive sur les basses tensions 2014/35/EU ont été respectés conforme à l'annexe I Nr. 1.5.1 der de la directive relative aux machines 2006/42/EC.  
Directiva de protecciones de baja tensión 2014/35/EU estan en acuerdo con el apéndice I No 1.5.1. de la directiva de maquinaria 2006/42/EC.  
Gli obiettivi di protezione della direttiva per basse tensioni 2014/35/EU è stata rispettata secondo allegato I n. 1.5.1 della Direttiva per macchine 2006/42/EC.  
De veiligheidsdoelstellingen van de laagspanningsrichtlijn 2014/35/EU zijn nageleefd in overeenstemming met nr. 1.5.1 van bijlage I van de machine richtlijn 2006/42/EC.  
Produkt spełnia wymogi bezpieczeństwa dyrektywy niskonapięciowej 2014/35/EU, zgodnie z załącznikiem I nr. 1.5.1 dyrektywy maszynowej 2006/42/EC.  
Цели, охраняемые Директивой по высоковольтному оборудованию 2014/35/EU, соблюдены в соответствии с приложением № 1.5.1 Директивы по машинному оборудованию 2006/42/EC.  
Açık Gerilim Yönetmeliği 2014/35/EU'nin konuyu hedeflerini, Makine Yönetmeliği 2006/42/EC, ek I no. 1.5.1'e göre uymuştur.  
Sigurnosni ciljevi direktive o niskom naponu 2014/35/EU udovoljavaju dodatku i br. 1.5.1. Direktive o strojevima 2006/42/EC.  
Upoštevani so zaštitni cilji Direktive o niski napetosti 2014/35/EU v skladu s prilogo I, št. 1.5.1 Direktive o strojih 2006/42/EC.  
Os objetivos de proteção da Diretiva de Baixa Tensão 2014/35/EU foram cumpridos de acordo com o Apêndice I, n.º 1.5.1 da Diretiva de Máquinas 2006/42/EC.  
Cile ochrany dle nízkonápnévé směrnice 2014/95/ES byly splněny dle přílohy I č. 1.5.1 směrnice o strojních zařízeních 2006/42/EC.

Bestätigt durch:  
Confirmed by:

Offenburg, 17.03.2016

ppa.

Harald Dirsch  
Direktor Produktentwicklung Europa  
Director Warewash Engineering Europe

## Controls

## 4 Controls

## 4.1 Controls

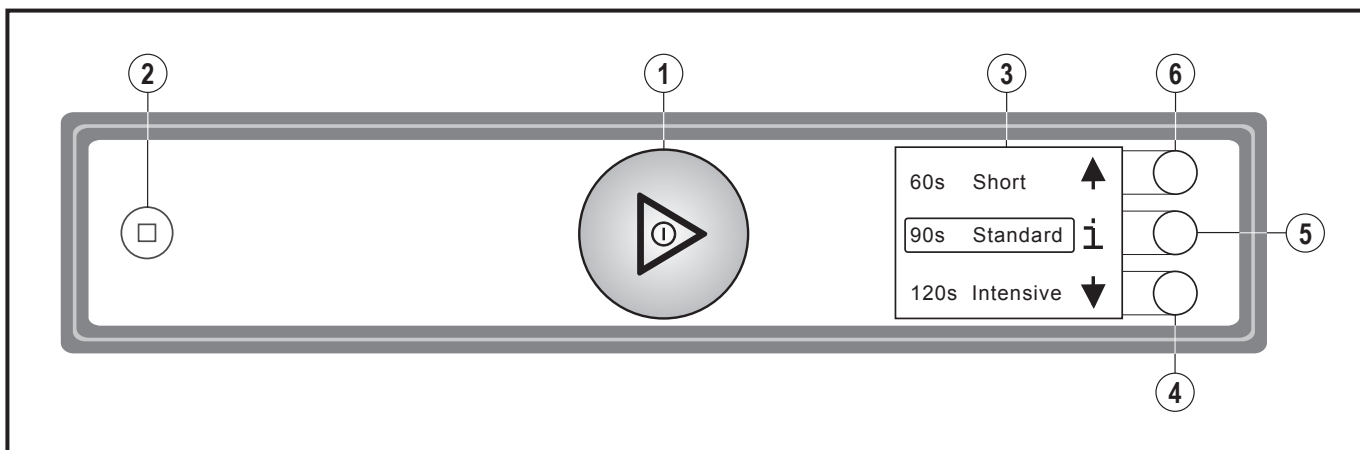



①	ON/OFF button	<p>Pushing this button switches the machine on.</p> <p>As soon as the machine is ready for operation, the wash program can be started by pushing this button.</p> <p>Pushing and holding (3 seconds) this button activates the automatic drain and self-cleaning cycle and switches off the machine automatically. After switch off, the machine is not voltage free!</p> <p>The button also shows the current operating state through different colours (see sections 4.2 and 4.3).</p>
②	STOP button	<p>In case of operating error or faults, the machine can be switched off immediately without the drain cycle by pushing this button.</p> <p>After switch off, the machine is not voltage free!</p>
③	Display	Selection menu/fault and information displays
④	Display navigation button	Scroll/set/select
⑤	Display navigation button	Change menu level/confirm/back/acknowledge fault
⑥	Display navigation button	Scroll/set/select

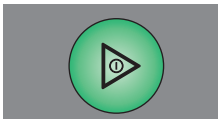
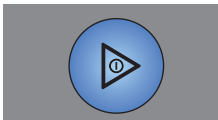

## 4.2 Operating states

In the operating panel display, the ON/OFF switch shows the current operating state through different colours.

	<p><b>Machine is Off</b></p> <p>The ON/OFF button is colourless.</p>
---	--

	<p><b>Machine being prepared for operation</b></p> <p>The ON/OFF button gradually goes green. The wash tank is being filled and the machine is heating up.</p>
	<p><b>Machine ready</b></p> <ul style="list-style-type: none"> <li>– The ON/OFF button illuminates completely green.</li> <li>– The machine is ready for the next wash cycle.</li> </ul>
	<p><b>Wash program starts</b></p> <ul style="list-style-type: none"> <li>– The ON/OFF button illuminates completely blue.</li> </ul>
	<p><b>Machine is washing</b></p> <ul style="list-style-type: none"> <li>– The ON/OFF button changes segment-by-segment from blue back to completely green.</li> </ul>
	<p><b>Switch off machine</b></p> <ul style="list-style-type: none"> <li>– The ON/OFF button changes segment-by-segment from green to colourless.</li> <li>– The machine is being emptied and switched off.</li> </ul>

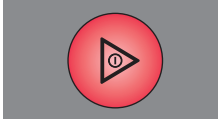
### 4.3 Display of faults and information

	<p><b>Fault: operation not possible</b></p> <ul style="list-style-type: none"> <li>– The ON/OFF button illuminates permanently red.</li> <li>– The fault is displayed.</li> <li>– For potential faults, see section <a href="#">9.1</a></li> </ul>
	<p><b>Information: limited operation is possible</b></p> <ul style="list-style-type: none"> <li>– The ON/OFF button illuminates green/red alternately.</li> <li>– The information is displayed.</li> <li>– For potential information, see section <a href="#">9.1</a></li> </ul>

### 4.4 Display function

The display is activated (when the machine is turned on) by pushing the display navigation buttons or moving your hand near to the display.

On activation, the wash program selection appears first. The selected program or function is highlighted.

The function of the display navigation buttons is context-dependent and shown in the display by symbols.

Further displays/menu levels can be selected using the © button. If no button is pushed, the display de-activates again after 10s.

### 4.5 Overview of main menus

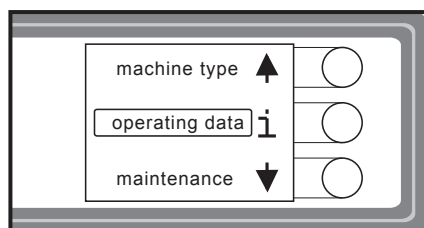
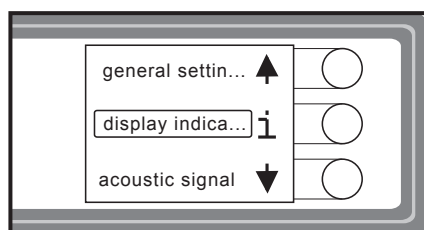
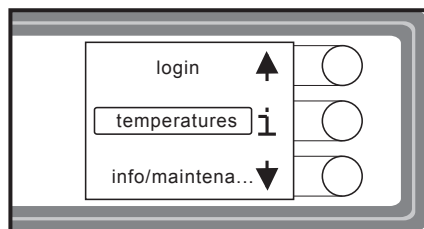
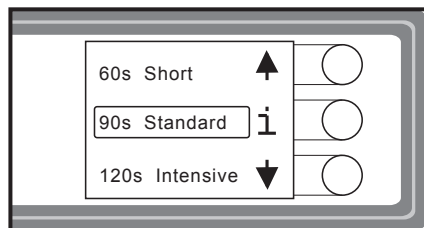

#### Program selection and info:

- Selects possible wash programs (depends on model variants)
- The ⓘ ("i") button accesses the **Login/Tempatures/Info** menu

#### Login/Tempatures/Info:

- Login: Operator code accesses **Operator menu**
- Temperatures: Displays tank and rinse temperatures.
- Info/maintanance: Accesses the **Info/Service** menu

#### Operator menu:

- Gen. settings: Accesses the machine settings
- Display indications: Accesses display settings
- Acoustic signal: Accesses the signal sensor setting
- ... see also section 8.1.

#### Info/Service:

- Machine type: Indicates machine type and serial number.
- Operating data: Displays operating data (see section 8.11).
- Maintanance: Displays service address.

















### 4.6 Overview of display symbols

#### 4.6.1 Wash cycle symbols

As an alternative to the text display, it is possible to switch to the symbol display (see section 8.6).

Symbol	Program
	Short
	Standard
	Intensive
	Cold rinse (GX-10A only)
	Hygiene

#### 4.6.2 Function symbols

Symbol	Function
	Scroll menu
	Accept value
	Alter value
	Info/Service
	Login
	back
	Temperatures
	Wash/rinse temperatures
	Sound on/sound off
	Timer
	Salt deficiency
	Chemical deficiency
	Fault
	Fill fault
	Drain fault
	Heating element fault

## Installation

## 5 Installation

## 5.1 Personnel qualification

Installation must only be carried out by qualified personnel (see section 2.2.2).

## 5.2 Special safety instructions

 **WARNING****Risk of electric shock, fire hazard**

Water (frost damage, machine overflow) flowing over live components can cause injury from electric shock or fire.

- ▶ Do not allow water to flow under live components.
- ▶ Make sure the machine is correctly stored (see frost damage section 2.3).
- ▶ Make sure that the machine does not overflow when being filled.

 **CAUTION****Risk of being crushed or knocked**

When being lifted or transported, the machine can overturn or fall and cause injury.

- ▶ Observe the instructions on the packaging for storage, lifting or transporting.

 **WARNING****Risk of explosion**

Installing the machine in a potentially explosive location can cause explosion and serious injury from ejected parts.

- ▶ Do not install machine in a potentially-explosive location.

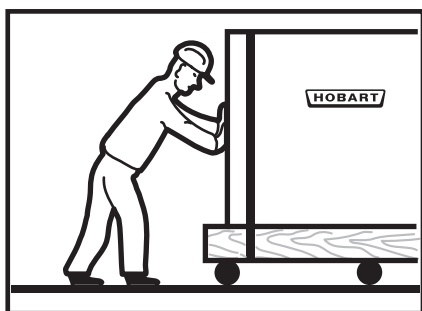

## 5.3 Transporting to the installation location

**NOTICE****Frost damage**

Temperatures below 0°C during transport/storage cause function impairments.

- ▶ Prior to installation, store the machine at room temperature (min. 15°C) for 24h.

- ▶ Where possible transport packed on the pallet.



- ▶ Use suitable transport means (elevating truck, crane etc.).
- ▶ If using a forklift, shim the machine with wooden trusses.

## 5.4 Removing the packaging



### CAUTION

#### Risk of electric shock, fire hazard

When the machine is unpacked, the connection cable can become damaged and cause injury from electric shock or fire.

- ▶ Do not damage the connection cable while unpacking the machine.
- ▶ Take cable measurement BGV A3.

- ▶ Remove packaging materials and accessories from the machine.
- ▶ Inspect the machine for possible transport damage.

## 5.5 Installing the machine



### WARNING

#### Risk of electric shock, fire hazard

Water ingress can cause short circuit and mortal danger from electric shock and fire.

- ▶ Machine must be shimmed and be accessible only from the front.
- ▶ If the machine cannot be shimmed, a rear cover must also be ordered.

Wall clearance is not required.

- ▶ Align machine by turning the adjusting feet according to the spirit level.
- ▶ Distribute machine weight equally onto all feet.

### NOTICE

#### Property damage

Vapour may escape from the dishwasher door and damage the furniture.

- ▶ Adjacent furniture has to be protected to prevent swelling.

### 5.6 Connecting to the power supply



#### WARNING

##### Risk of electric shock

Failure to connect properly to the power supply can cause mortal danger from electric shock.

- ▶ Have the machine connected to the power supply by an authorized technician according to the local and national codes. For Australia: in accordance with AS/NZS3500.1

**NOTE:** To guarantee the electrical safety of the machine, it must be connected to a protective earthing equipment conductor installed as specified. In addition, the machine must be connected on site to the equipotential bonding connection. The connecting screw () provided for this purpose is located next to the cable inlet.

These fundamental safety requirements and the professional design of the on-site installation must be verified by a qualified electrician.

**Hobart does not accept any liability for damage caused by improper installation! Any applicable local installation instructions must be observed!**

**The mains cable must be connected via a cut-out device (main switch or accessible plug device).**

Modification to an alternative power supply is possible as per the variants on the circuit diagram. Connection diagrams are located adjacent to the connection terminals.

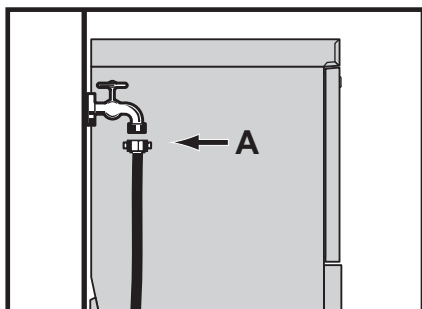

### 5.7 Connecting the water

**NOTE:** The machine must be operated with potable water.

- ▶ To utilize the switchable cold rinse function (GX-10A only), connect to cold water, if possible (max. 20°C).
- ▶ Connect to warm water, if possible (max. 60°C).

Water hardness:

- Machines without softener: max. 1 °d = 0.18 mmol/l.
- Machines with softener: max. 30 °d = 5.3 mmol/l.

Line flow pressure:

- Machines without softener: 0.5 – 10 bar
- Machines with softener: 0.8 – 10 bar
- If the line flow pressure is above 10 bar: provide pressure reducing valve.
- ▶ Connect the union nut “A” (3/4”) of the water supply hose to the site shut off valve.
- ▶ Do not kink or cut the water supply hose.

- ▶ Any required extension must be executed using a suitable pressure hose, e.g. 324088-1.

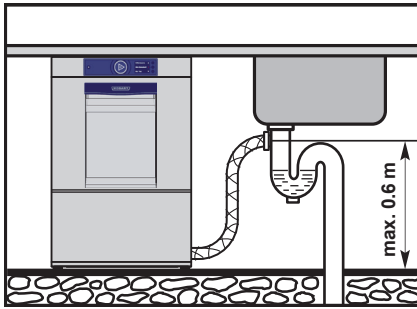

## 5.8 Connecting the drain

The connection between machine and site drain must not exceed the max. height of 0.6 m.

- ▶ Do not kink or lay the drain hose loose on the ground.

## 5.9 Retrofitting integrated chemical container (optional)



### WARNING

#### Risk of electric shock

Mounting the additional feed tanks, touching live parts (hot water tank heater, tank heating, pumps) when working under voltage

- ▶ Have additional feed tanks mounted by qualified personnel.



- ▶ For mounting, see installation instruction for feed tank kit.

## 6 Commissioning

---

### 6.1 Personnel qualification

---

Commissioning must only be carried out by qualified personnel (see section 2.2.2).

### 6.2 Starting the commissioning procedure

---

When the machine is turned on for the first time, the commissioning procedure starts automatically with the language selection, followed by further requisite commissioning steps.

- ▶ Push ON/OFF button ①.
  - ↳ Display is activated.
  - ↳ **Language** menu is displayed.

### 6.3 Setting the language

---

- ▶ Push display navigation button ④ or ⑥ until the required language is highlighted.
- ▶ Push button ⑤.
  - ↳ The language is activated.
  - ↳ **Set day** menu is displayed.

### 6.4 Setting the date

---

- ▶ Push display navigation button ④ or ⑥ until the required day is highlighted.
- ▶ Confirm with button ⑤ and skip to set month.
- ▶ Repeat the procedure as described to enter month and year.
- ▶ Push button ⑤.
  - ↳ The date is activated.
  - ↳ **Set time** menu is displayed.

### 6.5 Setting the time

---

- ▶ Push display navigation button ④ or ⑥ until the required hour is highlighted.
- ▶ Confirm with button ⑤ and skip to set minutes.
- ▶ Push display navigation button ④ or ⑥ until the required minute is highlighted.

- ▶ Push button ⑤.
- ↳ The time is activated.

## 6.6 Select reverse osmosis

---

Setting parameters of the machine according to the selection.

- ▶ Push display navigation button ④ or ⑥ until the required hardness is set.
- ▶ Push button ⑤.
- ↳ Parameters are adjusted.

## 6.7 Setting the water hardness (optional)

---

Machines with integrated softener have a water hardness setting.

**Note: The softener must be set to the existing water hardness (ask at the local water works).**

- ▶ Push display navigation button ④ or ⑥ until the required hardness is set.
- ▶ Push button ⑤.
- ↳ Water hardness is activated.

## 6.8 Filling the salt reservoir (optional)

---

On machines with integrated softener, an instruction to fill the salt reservoir appears during commissioning.

### NOTICE

#### Property damage

Accidentally filling the salt reservoir with detergent will damage the water softener.

- ▶ Do not fill the salt reservoir with detergent.



**Unlike the regular salt fill, additional water has to be added during the commissioning procedure.**

- ▶ Open the door.

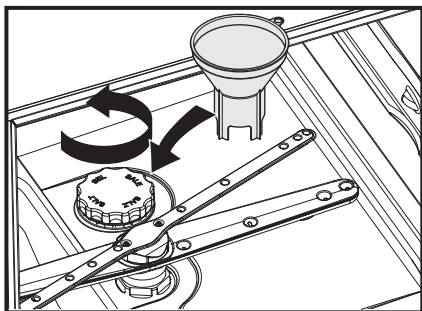

- ▶ Unscrew the salt reservoir lid and add 1,5 kg of granular (2-8 mm) regenerating salt (do not use salt tablets).

- ▶ Fill up the reservoir with potable water (only at commissioning).
- ▶ Make sure the lid seal is free of dirt and salt.
- ▶ Screw lid back on and tighten.

### NOTICE

#### Property damage

Salt residues on the tank bottom cause corrosion damage.

- ▶ Remove salt residues by hand.
- ▶ On completion of the commissioning procedure, start rinse program to remove all traces of salt if necessary.

- ▶ To continue the commissioning procedure, press button ⑤.

## 6.9 Filling the chemical container and chemical hoses



We recommend the use of HOBART Hyline detergent and rinse aid.



### CAUTION

#### Chemical burns, sensitisation of the skin, poisoning

The use of unsuitable chemicals can cause injury.

- ▶ Use only commercial detergent and rinse aid.
- ▶ Observe the manufacturer's application and safety instructions.



### WARNING

#### Chemical burns, sensitisation of the skin, poisoning

Filling the chemical container or chemical hoses with detergent or rinse aid for the first time incorrectly can cause serious injury.

- ▶ Wear protective equipment (gloves, safety goggles, protective clothing) when handling chemicals.



### 6.9.1 Provisioning external chemical canisters

On machines without integrated chemical container, an instruction to insert the suction hoses into the external canisters appears.

#### ***Preparing the detergent:***

- ✓ Suction height of dosing pump: max. 1.5 m.
- ▶ Place suction hose **without** colour marking at the suction valve at the bottom of the external reservoir.

#### ***Preparing the rinse aid :***

- ✓ Suction height of dosing pump: max. 1.5 m.
- ▶ Place suction hose with **blue** marking at the suction valve at the bottom of the external reservoir.

#### ***Filling the suction hoses:***

- ▶ Push button ⑤.
  - ↳ The instruction “Close the machine door” is displayed.
- ▶ Close the door and push button ⑤.
  - ↳ Chemical hose filling is activated.

The filling process is visualised in the display by a time bar.

### 6.9.2 Filling integrated chemical containers (optional)

On machines with retrofitted, integrated containers, the instruction to fill the chemical containers appears.

- ▶ Fill the **colourless** container with **detergent** to the “MAX” mark using a funnel. Do not overfill the container!
- ▶ **Blue** container fill the blue container with **rinse aid** to the “MAX” mark using a funnel. Do not overfill the container!
- ▶ Push button ⑤.
  - ↳ The instruction “Close the machine door” is displayed.
- ▶ Close the door and push button ⑤.
  - ↳ Chemical hose filling is activated.

The filling process is visualised in the display by a time bar.

It can be stopped by pushing button ② if necessary.

### 6.10 Completing the commissioning procedure

The machine can be started or switched off selectively.

- ▶ Push display navigation button ④ or ⑥ until the required setting is highlighted.
- ▶ Push button ⑤.
  - ↳ The setting is activated.

## 7 Operation

### 7.1 Personnel qualification

The machine must be operated by instructed personnel (see section 2.2.2).

### 7.2 Special safety instructions

#### CAUTION

##### **Chemical burns, sensitisation of the skin, poisoning**

If the Door is opened during operation, wash water can spurt out and cause injury.

- ▶ Do not open the Door during operation, wait for the program to finish.



#### WARNING

##### **Slipping**

Moisture can build up on the machine floor and cause slipping.

- ▶ Provide a floor covering that is guaranteed to be non-slip in case of moisture.



### 7.3 Notes for optimum washing result

The rinse result is significantly affected by the water quality. If the mineral content is high, the minerals dissolved become visible on the glasses in the form of spots and streaks during the drying process.



**Authorised HOBART service personnel can determine the content of minerals by measuring the electrical conductivity. Values of less than 80  $\mu\text{S}/\text{cm}$  are non-critical for rinsing glasses and cutlery. If the values are higher, we recommend the use of a HOBART HYDROLINE desalination cartridge or a reverse osmosis system.**

If you have any questions, please contact your authorised HOBART service partner.



**We recommend the use of special HOBART glass racks. HOBART racks hold the glasses in slightly inclined positions – this improves the rinse efficiency.**



To avoid unpleasant smelling glasses, only chlorine-free detergent should be used for washing the glasses.

Before washing new glasses the first time with a commercial glass washer, intensive basic cleaning is mandatory to reduce the greasy film which is on most glasses for protection during production. We recommend this basic clean is carried out by hand (wear gloves) with a higher detergent concentration (minimum 10 g/l) in a sink using a brush. Alternatively, the program described in section [7.11](#) can also be used.

## 7.4 Preparations for washing

### 7.4.1 Preparing the machine

- ▶ Check correct position of wash/rinse arms and strainers.
- ▶ Open site shut-off valve.
- ▶ Turn on main switch or insert the plug.
- ▶ Check level of detergent and rinse aid containers.
- ▶ Close Door.
- ▶ Push the ON/OFF button ①.
  - ↳ Machine is switched on.
  - ↳ The tank is filled.

The ON/OFF button will become gradually green during fill and heating cycle. This process can take several minutes.

When the button becomes completely green, the machine is ready for operation.



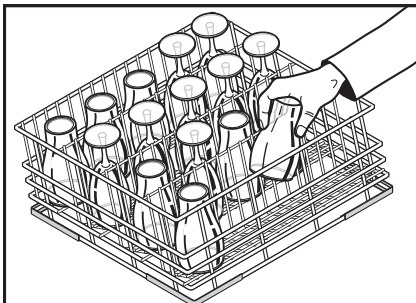

### 7.4.2 Preparing the washware

- ▶ Remove any food debris.
- ▶ Place washware face down in the rack.



## 7.5 Displaying and selecting the program

### 7.5.1 Overview of programs and additional functions

Name	Description	Alternative symbol display
Short	For slight contamination	
Standard	For normal contamination	
Intensive	For heavier soiling	
Cold rinse (GX-10A only)	for cooling glasses	
Hygiene	(see also section 7.10)	
Basic clean	Program for removing stubborn coatings/deposits on washware (see section 7.11)	without
Descaling	See section 7.12	without

### 7.5.2 Displaying and selecting the program

The machine rinses automatically using the standard program. If necessary, a different program can be selected.

- ▶ To display the current program before the start, activate the infrared sensor in the display by hand or push the display navigation button.
  - ↳ Display is activated.
  - ↳ **Program selection and info** menu is displayed.
  - ↳ The program currently selected is highlighted.
- ▶ To switch a different program push ④ or ⑥ navigation button until the required program appears and is highlighted.

The selected program can be started directly via ON/OFF button ①.

The machine continues with the last program to be selected until it is switched off.

## 7.6 Washing

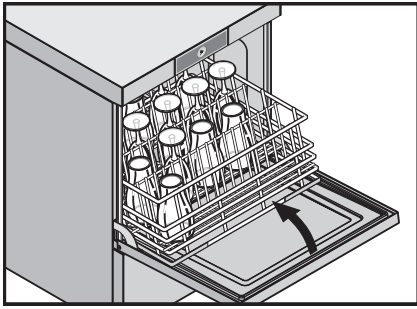

- ▶ Slide rack into the machine and close the door.

- ▶ Push the ON/OFF button ①.
  - ↳ While the program is running, the ON/OFF button gradually changes from blue back to green.
  - ↳ As soon as the ON/OFF button illuminates green again, the wash cycle is finished.
- ▶ Open the door and remove the rack.
- ▶ Allow the washware enough time to dry.

## 7.7 Switch off machine

- ▶ Close Door.
- ▶ Push the ON/OFF button ① for three seconds.
  - ↳ During pump-out, the ON/OFF button gradually changes from green back to colourless.



**During pump out, the machine interior is cleaned automatically. Then remove any coarse food residues.**

- ✓ When the ON/OFF button has extinguished completely:
  - ▶ Turn off main switch or remove the plug.
  - ▶ Close on-site shut-off valve.



**If no button is pressed, the machine switches off automatically after 6 hours, but will not pump out.**

## 7.8 Executing daily cleaning

### NOTICE

#### Property damage

The use of unsuitable agents can cause corrosion damage.

- ▶ Do not use any chloric, acidic or metal-containing additives to clean the machine.
- ▶ Do not use metal brushes.

- ▶ Open the door.
- ▶ Remove sieves and clean. **Make sure that food debris does not enter pump intake!**
- ▶ Flush the fine strainer under running water.
- ▶ Clean machine areas that cannot be reached by the water circulation of the self-cleaning function (door seal, etc.).
- ▶ Replace strainer.
- ▶ Leave the door open for ventilation.

## 7.9 Executing weekly cleaning

---

- ▶ Push and hold the clip fastener on the wash and rinse arms. Remove the wash and rinse arms and clean.
- ▶ Reinsert wash and rinse arms.

## 7.10 Executing hygiene cleaning

---

When a pre-set number of rinse cycles has been reached, the instruction "Execute hygiene program" appears in the display, indicating that an automatic hygiene clean of the machine interior should be executed.

- ▶ Before end of operation, remove the rack and place One HO-BART cleaning tablet in the machine interior.
- ▶ Close Door.
- ▶ Push ④ or ④⑥ navigation button until the hygiene programme appears and is highlighted.
- ▶ Press the ON/OFF key .

While the hygiene programme is running (duration approx. 10 minutes), the green illuminated segments extinguish successively.

At the end of the programme, the machine switches off automatically.



**If necessary, hygiene clean should be executed before the pre-set number of rinse cycles is reached. With regular use, the machine interior will remain free of food residues and deposits.**

---

## 7.11 Executing the basic cleaning program for washware

---

Special program for removing stubborn coatings/deposits on washware (e.g. protective film on new glasses, starch residues)



### CAUTION

#### Chemical burns, sensitisation of the skin, poisoning

The use of unsuitable chemicals can cause injury.

- ▶ Carry out the manual addition of a special agent according to the recommendation of your chemical supplier.
- ▶ Observe the manufacturer's application and safety instructions.

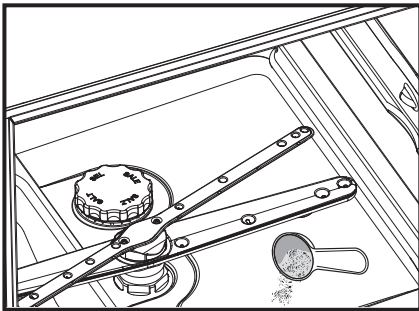

- ▶ Open the door.
- ▶ Remove coarse soiling from tank strainer by hand.
- ▶ According to the manufacturer's dosing recommendations, add the required powdered quantity for 8 litres of water to the flat side of the tank.

- ▶ Activate the infrared sensor in the display by hand or push the display navigation button.
  - ↳ Display is activated.
  - ↳ **Program selection and info** menu is displayed.
- ▶ Push ④ or ⑥ navigation button until the basic cleaning program appears and is highlighted.
- ▶ Slide the loaded rack into the machine and close the door.
- ▶ Push the ON/OFF button ①.
  - ↳ While the program is running (duration approx. 6 minutes), the ON/OFF button ① gradually changes from blue back to green.

As soon as the ON/OFF button illuminates green again, the rinse cycle is finished.



**For each basic cleaning cycle that follows immediately, an additional manual dosing is required for 4 litres of water.**

## 7.12 Executing the descaling program

Program for de-scaling the machine interior



### CAUTION

#### Chemical burns, sensitisation of the skin, poisoning

The use of unsuitable chemicals can cause injury.

- ▶ Carry out the manual addition of a special agent according to the recommendation of your chemical supplier.
- ▶ Observe the manufacturer's application and safety instructions.

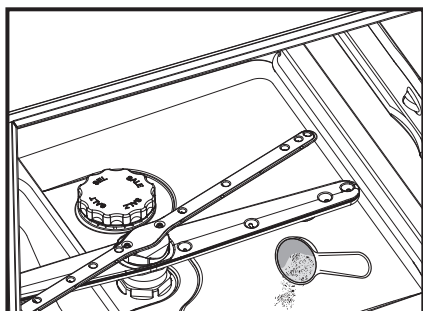

- ▶ Open the door.
- ▶ Remove coarse soiling from tank strainer by hand.
- ▶ According to the manufacturer's dosing recommendations, add the required de-scaling agent for 8 litres of water to the flat side of the tank.

- ▶ Activate the infrared sensor in the display by hand or push the display navigation button.
  - ↳ Display is activated.
  - ↳ **Program selection and info** menu is displayed.
- ▶ Push ④ or ⑥ navigation button until the de-scaling program appears and is highlighted.
- ▶ Close the door.
- ▶ Push the ON/OFF button ①.

As the hygiene program runs (duration approx. 10 minutes), the green illuminated segments extinguish successively.

At the end of the program, the machine switches off automatically.

## 7.13 Displaying the temperatures

This menu option is for displaying the current tank and rinsing temperatures.

#### Procedure:

- ▶ Activate the infrared sensor in the display by hand or push one of the display navigation buttons.
  - ↳ Display is activated.
  - ↳ **Program selection and info** menu is displayed.
- ▶ Push button .
  - ↳ **Login/Temperatures/Info** menu is displayed.
- ▶ Select the **Temperatures** menu option.
  - ↳ Current tank and rinsing temperatures are displayed.

## Setting options, operating and hygiene data

### 8 Setting options, operating and hygiene data

The machine can be operated as soon as the commissioning procedure is complete.

The following settings can be individually set as required using the operator menu.

#### 8.1 Overview of operator menu

Sub-menu	Function
General settings	Language Date Time Date format Time format Temperature unit
Display indications	Program representation Brightness Adjust contrast Temperature display
Acoustic signal	On/Off
Chemical settings	Detergent dosing Rinse aid dosing Filling chemical hoses
External water treatment	Set counter Reset counter Remaining water quantity Activating/deactivating (not for RO-I/V)
Hardness	Setting
Operating/hygiene data	Display operating data Display hygiene data Transmit report
Timer	Weekly program Timer program Activate/deactivate

#### 8.2 Opening the operator menu

✓ The machine must be switched on.

## Setting options, operating and hygiene data

---

- ▶ Activate the infrared sensor in the display by hand or push one of the display navigation buttons.
  - ↳ Display is activated.
  - ↳ **Program selection and info** menu is displayed.
- ▶ Push button ⑤.
  - ↳ **Login/Temperatures/Info** menu is displayed.
- ▶ Push display navigation button ⑥ until **Login** is highlighted.
- ▶ Push button ⑤.
  - ↳ Enter PIN is displayed.

### Enter operator code "1111":

- ▶ Push display navigation button ④ or ⑥ until a "1" is shown in the first place.
- ▶ Push button ⑤ and skip to the next number.
- ▶ Repeat the procedure as described until all numbers are entered.

The operator menu is displayed once the correct code has been entered.

## 8.3 Navigating, selecting and setting within the menu

---

### *Navigating and opening sub-menu:*

- ▶ Push ④ or ⑥ navigation button until the required sub-menu appears and is highlighted.
- ▶ Push button ⑤.
  - ↳ Menu is displayed.

### *Making and activating settings:*

- ▶ Push display navigation button ④ or ⑥ until the required setting is displayed and highlighted.
- ▶ Push button ⑤.
  - ↳ The setting is activated.

### *Back:*

- ▶ Push ④ or ⑥ navigation button until the **Back** menu option appears and is highlighted.
- ▶ Push button ⑤.
  - ↳ The next highest menu level is displayed.

## 8.4 Exiting the operator menu

---

- ▶ Open the Door and close it again, or do not press a key for 10 seconds!



## Setting options, operating and hygiene data

### 8.5 Making the general settings

The following settings can be entered into the **General settings** sub-menu.

Setting	Selection
Language	is set as default during commissioning, see sections <a href="#">6.3</a> to <a href="#">6.5</a>
Date	
Time	
Date format	YYYY.MM.DD DD.MM.YYYY MM.DD.YYYY
Time format	24h / 12h
Temperature unit	°C / °F

#### **Making the settings:**

- ▶ Open the operator menu, see section [8.2](#).
- ▶ Open the **General settings** sub-menu and make the setting, see section [8.3](#).

### 8.6 Setting the display indications

The following settings can be entered into the **Display indications** sub-menu.

Setting	Selection
Program representation	Text display Symbol display (see section <a href="#">4.6.1</a> )
Display brightness	Set brightness
Display contrast	Set contrast
Temperature display	Activate/deactivate

#### **Making the settings:**

- ▶ Open the operator menu, see section [8.2](#).
- ▶ Open the **Display indications** sub-menu and make the setting, see section [8.3](#).

### 8.7 Setting the acoustic signal

An acoustic signal can be switched on or off in the **Acoustic signal** sub-menu.

Setting	Selection
Set signal sensor	Sound on/sound off

## Setting options, operating and hygiene data

### **Making the settings:**

- ▶ Open the operator menu, see section 8.2.
- ▶ Open the **Acoustic signal** sub-menu and make the setting, see section 8.3.

## 8.8 Making the chemical settings

The following settings can be entered into the **Chemical settings** submenü.

Setting	Selection
Detergent dosing	Factory setting: 2,5 g/l Possible range: 0–9.5 ml
Rinse aid dosing	Factory setting: 0,3 g/l Possible range: 0–2.0 g/l
Filling chemical hoses	Fill detergent suction hose NO/YES Fill rinse aid suction hose NO/YES

### **Making the settings:**

- ▶ Open the operator menu, see section 8.2.
- ▶ Open the **Chemical settings** submenü and make the setting, see section 8.3.

If in the **Fill chemical hoses** submenu, the prompt **Fill detergent suction hose** and/or **Fill rinse aid suction hose** are set to **Yes**, the filling process will start.

The filling process is visualised in the display by a time bar.

**NOTE: The hose filling for detergent only functions when the door/hood is closed.**

It can be stopped by pushing button ② if necessary.

## 8.9 Configuring the counter for external water treatment (optional)

The following settings for an optional external water treatment can be entered into the **External water treatment** submenu.

Setting	Selection
Set counter	Set counter Factory setting: not activated
Reset counter	Reset counter NO Reset counter YES

## Setting options, operating and hygiene data

Setting	Selection
Remaining water quantity	Remaining capacity external water treatment  Displays the current demineralisation counter status (remaining water quantity until the demineralization cartridge is depleted).
Activate/deactivate	Activates or deactivates the evaluation of the remaining capacity External water treatment.

### **Making the settings:**

- ▶ Open the operator menu, see section 8.2.
- ▶ Open the **External water treatment** submenu and make the setting, see section 8.3.

## 8.10 Setting the water hardness (optional)

With optional softener only.

**Note: The softener must be set to the existing water hardness (ask at the local water works).**

The following settings can be entered into the **Set water hardness** sub-menu.

Setting	Selection
Water hardness setting	is set as default during commissioning  Factory setting: 30°dH  Possible range: 0–30°dH

### **Making the settings:**

- ▶ Open the operator menu, see section 8.2.
- ▶ Open the **Set water hardness** sub-menu and make the setting, see setting 8.3.

## 8.11 Displaying the operating/hygiene data

The following data can be called-up from the **Operating/hygiene data** sub-menu.

## Setting options, operating and hygiene data

Setting	Selection
Display operating data	Commissioning date Operating hours until next service Operating hours overall Wash cycles overall Water consumption overall Operating days/hours Daily wash cycles Daily water consumption Remaining capacity for external water treatment
Hygiene data	See section <a href="#">8.11.1</a>
Report	See section <a href="#">8.11.2</a>

### Display the setting:

- ▶ Open the operator menu, see section [8.2](#).
- ▶ Open the **Operating/hygiene data** sub-menu.
- ▶ Open the corresponding sub-menu and display the setting, see section [8.3](#).

### 8.11.1 Display hygiene data

Hygiene-relevant events, data and messages are listed in this menu option.

The list starts with the current date and the last event that occurred on this day. The subsequent events occurring on this day then appear, followed by the events occurring the day before.

A maximum of 1500 events are saved. Older lists are deleted.

Pushing button  opens the list of completed wash programs.

#### The following data are saved:

Hygiene data	Program set point temperature too low
	Thermal disinfection aborted
	Wash process aborted
Messages	Rinse aid empty
	Rinse aid deficiency remedied
	Detergent empty
	Detergent deficiency remedied
	Salt empty
	Salt deficiency remedied
	Service interval expired
Half-cartridge depleted	

## Setting options, operating and hygiene data

Events	Filling program
	Pump-out program
Washing program	

### 8.11.2 Transmit report

This menu option is for transmitting operating and hygiene-relevant data in txt format to a USB stick. This format can be imported and processed using standard software.

**Procedure:**

- ▶ Open the door.
- ▶ Remove sealing cover from USB port (top right near door sealing).
- ▶ Insert USB stick into the port.
- ▶ Select the **Report** menu option.
  - ↳ After a successful download, a message appears in the display.
- ▶ Remove USB stick.
- ▶ Close off USB port with the sealing cover.

### 8.12 Setting automatic switch-on

The **Timer** sub-menu is for defining times for automatic machine switch-on.

This can be done in two ways:

- The **Weekly program** menu option can be used to define various switch-on times for individual weekdays.
- The **Daily Timer program** can be used to define a non-recurring switch-on time for today's date.

The switch-on must be set to active via the separate **Activate/deactivate** menu option. The text frame shows the most recently selected of the four options. When switch-on is activated, a small clock symbol remains in the top left-hand section of the display for 30 minutes after the machine has been turned off.

Setting	Selection
Weekly program	Weekdays and times
Daily Timer program	Date and time
Activate/deactivate	Weekly timer ON Daily Timer program ON Weekly and Daily Timer program ON Timer OFF

## Setting options, operating and hygiene data

---

### ***Making the settings:***

- ▶ Open the operator menu, see section 8.2.
- ▶ Open the **Timer** sub-menu and make the setting, see section 8.3.

### ***Daily Timer program***

The date and time can be selected and altered using the display navigation buttons.

The switch-on must also be set to active via the separate **Activate/deactivate** menu option.

When the time and date are reached, the machine switches on.

### ***Weekly program***

Weekdays and an individual switch-on time can be selected and altered using the display navigation buttons.

For weekdays on which **no** switch-on is to occur, **no** time may be saved.

After the switch-on times for each weekday have been entered, the switch-on must be set to active via the separate **Activate/deactivate** menu option.

When the time is reached, the machine switches on.

### ***Activate/deactivate***

The **Activate/deactivate** menu option offers the following four selection options:

- **Daily timer on:** Automatic switch-on is activated for an **entered day's date**.
- **Weekly timer on:** Automatic switch-on is activated for the **saved weekdays and individual times**.
- **Daily and weekly timer on:** Automatic switch-on is activated for an **entered day's date and for the saved weekdays**.
- **Timer off:** Automatic switch-on is **generally deactivated**.

## 9 Fault indications and problems

### 9.1 Fault indications

Displayed error messages are shown in the order of priority. They **must** be acknowledged via the display navigation button .

Acknowledged error messages for which the error is still pending are first hidden to enable further messages to be displayed.

If all fault messages have been acknowledged but errors are still pending, these messages will then be shown again.

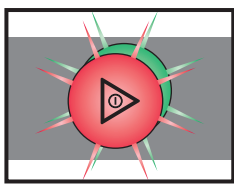

#### Information

- Limited operation is possible.
- The ON/OFF button  illuminates green/red alternately.
- The error code is shown in the display (see table).

Error code	Message text	Measure
003	Temperature not reached. Contact service technician.	Contact your HOBART Service Partner.
004	Temperature not reached. Contact service technician.	Contact your HOBART Service Partner.
008	Temperature not reached. Contact service technician.	Contact your HOBART Service Partner.
009	Temperature not reached. Contact service technician.	Contact your HOBART Service Partner.
021	Fault in the drain system. Clean the drain hose if necessary and pump-out the machine again.	Clean the drain hose if necessary and pump-out the machine again.
022	Fault in the drain system. Clean the drain hose if necessary.	Clean the drain hose if necessary.
029	Program aborted. Close Door.	Close Door.
036	Detergent deficiency. Refill detergent.	Refill detergent (see section 6.9).
037	Rinse aid deficiency. Refill rinse aid.	Refill rinse aid (see section 6.9).
038	Input voltage too high! Machine has been switched off.	Have the input voltage checked by the (site) electrician.
039	Filling program aborted. Close Door.	Close Door.
041	External water treatment depleted. Replace.	Replace part or full desalination cartridge.
042	Osmosis pre-filter depleted. Replace.	Replace pre-filter.
043	Salt deficiency. Refill regenerating salt.	Refill regenerating salt.

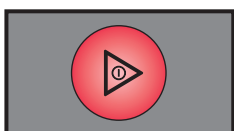

#### Faults

- Limited operation is not possible.
- The ON/OFF button  illuminates permanently red.
- The error code is shown in the display (see table).
- Once the error display has been acknowledged, the machine switches off.

## Fault indications and problems

Error code	Message text	Measure
001	Hot water tank temperature sensor fault. Contact service technician.	Contact your HOBART Service Partner.
002	Hot water tank temperature sensor fault. Contact service technician.	Contact your HOBART Service Partner.
006	Wash tank temperature sensor fault. Contact service technician.	Contact your HOBART Service Partner.
007	Wash tank temperature sensor fault. Contact service technician.	Contact your HOBART Service Partner.
011	Wash chamber temperature sensor fault. Contact service technician.	Contact your HOBART Service Partner.
012	Wash chamber temperature sensor fault. Contact service technician.	Contact your HOBART Service Partner.
013	Disinfection not guaranteed. Contact service technician.	Contact your HOBART Service Partner.
014	Booster pressure sensor fault. Contact service technician.	Contact your HOBART Service Partner.
015	Booster pressure sensor fault. Contact service technician.	Contact your HOBART Service Partner.
016	Wash tank pressure sensor fault. Contact service technician.	Contact your HOBART Service Partner.
017	Tank pressure sensor fault. Contact service technician.	Contact your HOBART Service Partner.
018	Fault in the filling or drain system. Contact service technician.	Contact your HOBART Service Partner.
019	Strainer blocked. Remove, clean and re-insert.	Remove, clean and re-insert strainer.
020	Wash tank pressure sensor fault. Pump-out machine.	Pump-out machine.
023	Fault in the filling system. Supply quantity too low.	Check site flow pressure.
031	Fault in the filling system. Check water supply.	Check water supply.
032	Fault in the filling system. Check water supply.	Check water supply.
033	Fault in the filling system. Contact service technician.	Contact your HOBART Service Partner.
035	Insert tank cover strainer correctly.	Insert tank cover strainer correctly.
044	Salt deficiency. Refill regenerating salt.	Refill regenerating salt.
045	Number of wash cycles without regenerating salt exceeded. Contact service technician.	Contact your HOBART Service Partner.
052	Fault in the filling or drain system. Contact service technician. Disconnect machine from the water and power supply!	Contact your HOBART Service Partner.



## Fault indications and problems

## 9.2 Remediating the problem

### 9.2.1 Poor wash result

Nature of the problem	Possible cause	Remedy
Washware not clean.	Wash arms stiff (you should be able to turn them easily by hand).	Remove wash arms and clean them thoroughly.  Also check water outlet from machine to wash arms is clear.
	Wash arm nozzles are clogged (visual check).	Remove wash arms, remove cleaning caps and rinse wash arms thoroughly until all soiling is removed.  Replace cleaning caps.
	Rinse nozzles clogged (usually by lime deposit).	Remove rinse arms and decalcify them in separate container.  Check site softener system for function.
	Regeneration concentration is too low or too high.	Check detergent concentration setting.
	Coarse strainer clogged.	Remove, empty and clean strainer.
	Fine strainer clogged or obstructed by lime deposits.	Remove fine strainer. If heavily soiled, soak in a vinegar solution. Then clean it thoroughly with a brush until the pores are free.  The fine strainer should generally be cleaned daily (see operating instructions).
	Wrong program selected for heavily soiled washware.	Select program with longer wash cycle.
Washware does not dry properly.	Rinse aid dosing too low.	Increase concentration (see operating instructions).
	Washware still greasy.	Detergent concentration too low: increase (see operation instructions).  Check if detergent is appropriate. If not, choose a stronger one.  Drain contaminated water and refill machine. Clear washware more thoroughly beforehand.
	Rack is not suitable for type of dishes (sloping).	Use appropriate racks to create a sloping position which allows water to drain away from cavities.
	Washware remains in the machine too long at the end of rinse cycle.	Remove washware as soon as cycle is completed to enable it to dry.

## Fault indications and problems

Nature of the problem	Possible cause	Remedy
Streaks and spots on washware.	Rinse aid concentration too high (stripe or bubble formation).	Reduce concentration (see operating instructions).
	Hard water or high mineral content.	Check water quality.  Every local water works holds data on the composition of the water they supply and will provide these on request.  Reference values: Ideal calcium value: 0 – 3 °d (total hardness). Ideal mineral content value: for glasses, max. conductivity 100 µS/cm, for dishes, still viable to max. 400 µS/cm.
	Rack is not suitable for type of dishes (sloping).	Use appropriate racks to create a sloping position which allows water to drain away from cavities.
	Inadequate rinse aid dosing causes stains.	Increase rinse aid concentration (see operating instructions).
	Machines with integrated softener: use of wrong salt (e.g. tablets).	Do not use salt tablets.

### 9.2.2 Other problems

Nature of the problem	Potential causes	Remedy
Glasses are totally or partially cloudy.	Surface of glasses is rough and porous, this is called glass corrosion.	Use new glasses, this is not caused by a malfunction on the machine.
Glass/dish breakage.	Use of unsuitable dish or glass racks.	Use suitable racks.
Machine switches off suddenly during operation.	Machine coupled to a maximum system or locked against other current consumers.	Have machine connected separately (electrician!).
	A site fuse has tripped.	Check site fuses.

## 10 Maintenance

---



In order to maintain the warranty, as well as a permanently safe, efficient, and trouble-free operation of the machine(s), the required maintenance must be carried out by authorized service technicians.

We therefore recommend the conclusion of an inspection and maintenance contract, which guarantees qualified support by specially trained service technicians according to a time schedule based on the operating conditions.

Genuine spare parts must be used for repairs and wearing part replacements. Wearing parts include dosing hoses, rinse arm bearings, etc.

In Germany, your HOBART machines are governed by the Ordinance on Industrial Health and Safety and must be inspected by a qualified electrician in accordance with the intervals specified by the Institute for Work and Health of the German Social Accident Insurance [DGUV V3 (BGV A3)].

## Disposal

---

### 11 Disposal

---



The machine operator is responsible for disposing of the machine and its operating materials correctly and in accordance with environmental regulations. Observe the national and local legal provisions and regulations.



**HOBART GmbH**

Robert-Bosch-Str. 17  
77656 Offenburg  
Deutschland  
Tel.: +49 (0)781.600-0  
Fax: +49 (0)781.600-23 19  
E-Mail: [info@hobart.de](mailto:info@hobart.de)  
Internet: [www.hobart.de](http://www.hobart.de)

**Hobart UK.**

Southgate Way,  
Orton Southgate,  
Peterborough  
PE2 6GN  
United Kingdom  
Tel.: +44 (0)844 888 7777  
Republic of Ireland: +353 (0)1246 0248  
Fax: +44 (0)1733 361 347  
E-mail: [sales@hobartuk.com](mailto:sales@hobartuk.com)  
Internet: [www.hobartuk.com](http://www.hobartuk.com)

**Compagnie HOBART SAS**

Allée du 1er mai  
77183 Croissy Beaubourg  
FRANCE  
Tel: +33 (0)1 64 11 60 00  
Fax: +33 (0)1 64 11 60 10  
E-mail: [contact@hobart.fr](mailto:contact@hobart.fr)  
Internet: [www.hobart.fr](http://www.hobart.fr)

**Hobart Nederland BV**

Pompmlenlaan 12  
3447 GK Woerden  
Telefoon +31 (0)348 462626  
Fax: +31 (0)348 430117  
E-mail: [info@hobartnederland.nl](mailto:info@hobartnederland.nl)  
Internet: [www.hobartnederland.nl](http://www.hobartnederland.nl)

**Hobart Foster Belgium bvba/sprl**

Industriestraat 6  
1910 Kampenhout  
Telefoon +32 (0) 16.60.60.40  
Fax +32 (0) 16.60.59.88  
E-mail: [info@hobart.be](mailto:info@hobart.be)  
Internet: [www.hobart.be](http://www.hobart.be)

**Hobart Norge**

Gamle Drammenvei 120  
N-1363 Høvik  
Tlf.: +47-67109800  
E-post: [post@hobart.no](mailto:post@hobart.no)  
Hjemmeside: [www.hobart.no](http://www.hobart.no)

**Hobart Scandinavia ApS**

Håndværkerbyen 27  
2670 Greve  
Danmark  
Tlf.: +45 4390 5012  
Fax.: +45 4390 5002  
E-mail: [salg@hobart.dk](mailto:salg@hobart.dk)  
Internet: [www.hobart.dk](http://www.hobart.dk)

**Hobart Sweden/Finland**

Tel: +46 8 584 50 920  
E-mail: [info@hobart.se](mailto:info@hobart.se)  
Internet: [www.hobart.se](http://www.hobart.se)

**Australia****Hobart Food Equipment**

Unit 1 / 2 Picken Street,  
Silverwater NSW, 2128  
Tel: +61 1800 462 278  
Fax: +61 02 9714 0222  
E-mail: [sales@hobartfood.com.au](mailto:sales@hobartfood.com.au)  
Internet: [www.hobartequipment.com.au](http://www.hobartequipment.com.au)

**HOBART China**

15th Floor, Building A  
New Caohejing International Business  
Center  
391 Gui Ping Road  
Shanghai, 200233  
Telephone: +86 (0)21 34612000  
Fax: +86 (0)21 34617166  
Internet: [www.hobartchina.com](http://www.hobartchina.com)