



Catalogue
FOOD SERVICE
Chapter
COOKING

Specific model
F-G9115 NG 230V 1N 60Hz 1C

19081733

11/11/2021

DENOMINATION:

Gas fryer, NG 60Hz, 1 stamped tank of 15 L, 900 range.

DESCRIPTION :

- Surface tops manufactured in 2 mm thick AISI-304 stainless steel.
- Laser-cut joints, automatic welding and polishes. Screws hidden from view.
- Tank stamped into the surface top with robotized weld and polish.
- Cold zone in the lower part of the well, which helps to maintain the quality and characteristics of the oil in use for longer.
- Safety thermostat in all models.
- Unloading of oil from the well by means of a robust and reliable ball valve, resistant to high temperatures.
- With individual lids for each well.
- High temperature enamelled cast iron flue protector.
- Access to the components from the front.
- Machines with IPX5 grade water protection.
- Voltage for electric models:
- 400 V 3+N . Ask for other models.
- Thermostatic temperature control between 60 and 200 °C.
- High-power machines which heat up very fast and with a high power:litre ratio (up to 1.00 kW/litre in gas models).
- Gas models with three longitudinal heating tubes integrated into the well.
- High efficiency gas burners.
- Ignition by spark train for the gas models.

POSSIBLE OPTIONS :

- 230 1N- Transformation A 230 V single phase
- 230 III - A 230 V three-phase transformation without neutral
- MARINE - Other machines - Ship transformation - 440 III

POSSIBLE ACCESSORIES :

- FOOD SERVICE
- STANDS 900
- REFRIGERATED STANDS
- ACCESSORIES KORE
- FRYER ACCESSORIES KORE
- KORE WHEELS
- TALL CHIMNEY KORE

SUPPLIED ACCESSORIES:

- 12233189 Complete basket F-7-15l 1

DIMENSIONS

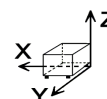

X Width	400 mm	X Gross width	440 mm
Y Depth	930 mm	Y Gross depth	1022 mm
Z Height	850 mm	Z Gross height	1255 mm
Net Weight	75,0 kg	Gross Weight	90,0 kg
Net volume	0,320 m3	Gross volume	0,564 m3

ELECTRICITY TECHNICAL SPECIFICATIONS

Electric power	0,100 kW
Amperage (A)	2A
Voltage	230V - 1N
Electric frequency	60Hz

GAS TECHNICAL SPECIFICATIONS

Gas type	NG
Gas power	15,00 kW
Gas consumption	2,080 m3/h
Regulated	NG G20/G25/G25.1 20/25/25 mbar

CONNECTIONS TECHNICAL SPECIFICATIONS

Gas diameter 1	R3/4"
----------------	-------



Catalogue
FOOD SERVICE

Capítulo
COOKING

Modelo
F-G9115 NG 230V 1N 60Hz 1C

19081733

11/11/2021

F-G9115 & F-G9121

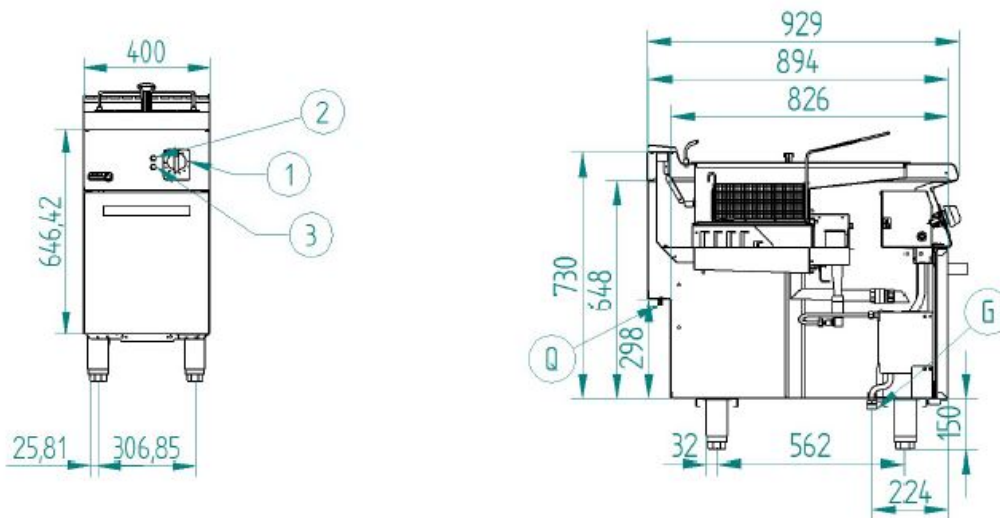

F-G9215 & F-G9221

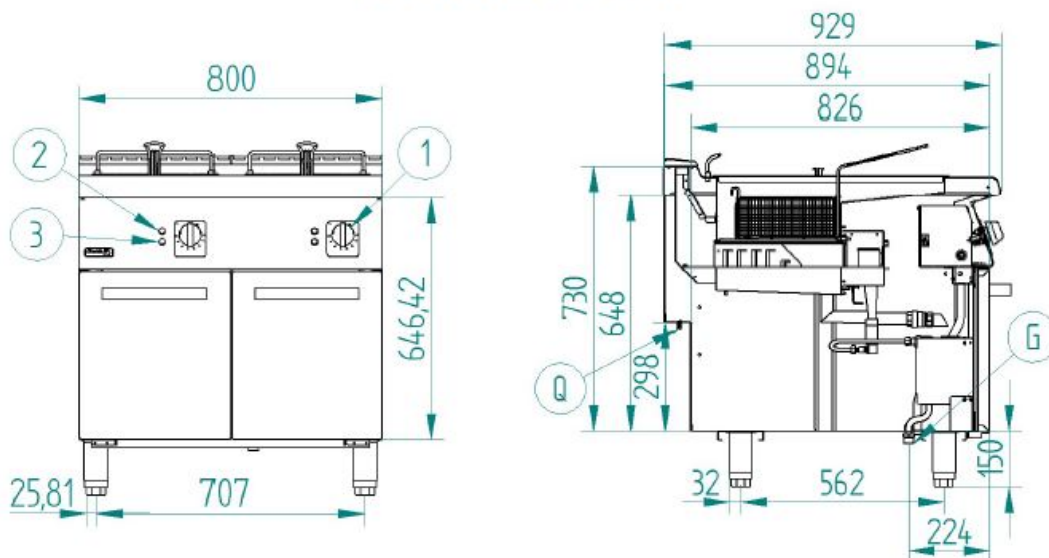

Q – Conexión equipotencial
G – Entrada de Gas
1 – Grifo válvula de gas
2 – Piloto verde
3 – Piloto ambar

Equipotential connection
Gas Inlet
Gas valve tap
Green pilot
Ambar pilot