

Panasonic®

Operating Instructions

Commercial Microwave Convection Oven

Model No. **NE-SCV2**



Thank you for purchasing this Panasonic product.

Please read these instructions completely before operating this oven and keep for future reference. Before using this product, **please pay extra attention to “Important Safety Instructions” (pages 4–9).**

This product is an equipment that fulfills the European standard for EMC disturbances (EMC = Electromagnetic Compatibility) EN 55011. According to this standard this product is an equipment of group 2, class B and is within required limits. Group 2 means that radio-frequency energy is intentionally generated in the form of electromagnetic radiation for warming and cooking of food. Class B means that this product may be used in normal household areas.

Manufactured by: Panasonic Corporation, 1006 Oaza Kadoma,
Kadoma City, Osaka, Japan
Importer: Panasonic Marketing Europe GmbH
Panasonic Testing Centre,
Winsbergring 15, 22525 Hamburg,
Germany

Sound pressure level is less than
70 dB (A weighted).

Contents

	Page
Important Safety Instructions	4
Types of Container to Use	10
Cooking Modes	11
Basic Usage	12
Cooking Chart	14
Accessories	16
Parts of your Oven	18
Instruction for Stacking	20
How to Operate the Touch Screen	21
Memory	21
Manual	21
Cooling	22
Tools	23
Preheating	28
Manual Cooking	29
Convection Cooking	29
Grill Cooking	30
Convection-and-Grill Cooking	31
Convection-and-Microwave Cooking	32
Grill-and-Microwave Cooking	33
Cooking in Steps	34
Memory Cooking	36
How to Save Memory	36
How to Delete Memory	38
How to Modify Memory	39
How to Set the Memory Number Figure	40
Cooking with a Saved Cooking Programme	41
Care of your Oven	42
Regular Maintenance	45
Troubleshooting	46
Common Queries	47
When to Call a Service Agent	48
SD Memory Card	50
Specifications	53
Information on Disposal	54

Important Safety Instructions

INSTALLATION

EXAMINE YOUR OVEN

Unpack the oven, remove all packing material, and examine the oven for any damage such as dents, broken door latches or cracks in the door. Notify the dealer immediately if the unit is damaged. DO NOT install it if the unit is damaged.

EARTHING

IMPORTANT: FOR PERSONAL SAFETY, THIS OVEN MUST BE PROPERLY EARTHED.

When an outlet is not earthed, it is personal responsibility and obligation of the customer to have it replaced with a properly earthed outlet.

VOLTAGE AND POWER WARNING

The voltage used must be the same as specified on the oven. Using another voltage than that which is specified is dangerous, and may result in a fire or other type of accident causing damage. Do not plug your oven in via an extension cable as this can be dangerous. The back of the oven heats up during use. Do not allow the cord to be in contact with the back of the oven or cabinet surface.

PLACEMENT OF THE OVEN

Locate the oven on a surface which is flat and stable. The oven is freestanding type and shall not be placed in a cabinet. Do not place the oven in a hot or damp place; e.g. near a gas or electric range. Do not operate the oven when the room temperature is higher than 40°C and/or the humidity is more than 85%. Free airflow around the oven is important. There is a possibility of a small amount of interference with weak broadcast signals if the oven is too close to a radio or TV. For safe and efficient operation, the oven must have sufficient air flow to the air vents i.e. at least 10 cm at both sides, 3 cm at the rear and 20 cm at the top. The front side must not be blocked. Do not install the oven at 150 cm or more above the floor. Doing so may result in danger of burns. Only a combination of same models are allowed when stacking. Oven must be placed for easy access to control panel and door and also, for disconnect power or shut off power by fuse or circuit breaker.

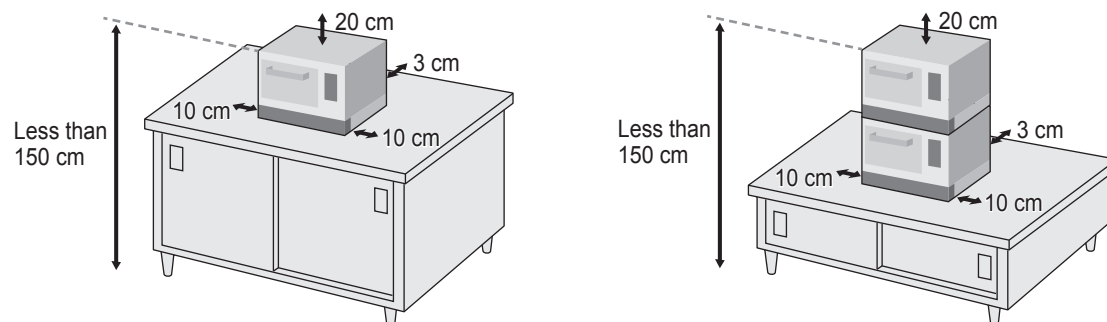

An external equipotential bonding conductor is provided at the back side of the oven and it is marked by this symbol.

⚠ WARNING

1. If the door or door seals are damaged, the oven must not be operated until it has been repaired by a competent person.
2. The contents of feeding bottles and baby food jars must be stirred or shaken and the temperature checked before consumption, in order to avoid burns.
3. Liquids and other foods must not be heated in sealed containers since they are liable to explode.
4. Microwave heating of beverages can result in delayed eruptive boiling, therefore care must be taken when handling the container.
5. It is hazardous for anyone other than a competent person to carry out any service or repair operation that involves the removal of a cover which gives protection against exposure to microwave energy.
6. Floor at adjacent to the oven may be slippery, care should be taken.
7. Oven must be disconnected from their power supply during cleaning or maintenance and when replacing parts.
8. To avoid scalding, do not use loaded containers with liquids or cooking goods which becomes fluid by heating in higher levels than those which can be easily observed.
9. Accessible parts may become hot during use. Young children should be kept away.
 - Always follow "Types of Container to Use". (p.10)

Important Safety Instructions

CAUTION

1. To reduce the risk of burns, electric shock, fire, injury to persons or excessive microwave energy, read all instructions before using oven.
2. In order to maintain the high quality of the magnetron tubes and other components, you are requested not to turn the oven on with no food inside.
3. High voltages are present inside the cabinet. Repairs and adjustments should be done only by qualified service personnel.
4. This oven requires free airflow in the back and front for maximum cooling efficiency. You should keep the air vents clear while cooking.
5. Do not dry clothes in the oven since there is a possibility of the clothes burning if left in the oven for too long of a time.
6. Use this oven only for its intended use as described in this manual.
7. Do not use this oven or accessories, if they are not working properly, or if they have been damaged or dropped.
8. Do not use outdoors.
9. Do not immerse cord or plug in water.
10. Keep cord away from heated surfaces.
11. Do not let cord hang over edge of table or counter.
12. To reduce the risk of fire in the oven cavity:
 - a) Do not overcook food. Carefully attend oven if paper, plastic, or other combustible materials are placed inside the oven to facilitate cooking.
 - b) Remove wire twist-ties from bags before placing bag in oven.
 - c) If materials inside the oven should ignite, keep oven door closed, unplug the oven, or shut off power at the fuse or circuit breaker panel.

●Always follow “Types of Container to Use”. (p.10)
13. Do not store flammable materials next to, on top of, or in the oven. It could be a fire hazard.
14. Do not overturn or drop this oven or accessories. Doing so may cause injury, electric shock, or microwave leakage.
15. Do NOT use this oven to heat chemicals or other non-food products. Do NOT clean this oven with any product that is labelled as containing corrosive chemicals. The heating of corrosive chemicals in this oven may cause microwave radiation leaks.
16. Do not use your oven for home canning or the heating of any closed jar. Pressure will build up and the jar may explode. In addition, the oven cannot maintain the food at the correct canning temperature. Improperly canned food may spoil and be dangerous to consume.
17. Do not attempt to deep fat fry in your oven.

18. Potatoes, apples, egg yolks, whole squash and sausages are examples of foods with nonporous skins. This type of food must be pierced before cooking, to prevent bursting.
19. When reheating babies bottles always remove top and teat. Liquid at the top of the bottle will be much hotter than at the bottom and must be shaken thoroughly before checking the temperature. The lid must also be removed from babies food jars, the contents must also be stirred or shaken before the temperature is checked.

●Always follow “Types of Container to Use”. (p.10)
20. The door seals and door seal areas should be cleaned with a damp cloth.
21. If smoke is observed, turn off or unplug the oven and keep the door closed in order to stifle any flames.
22. If the supply cord is damaged, it must be replaced by the manufacturer, its service agent or similarly qualified persons in order to avoid a hazard.
23. Before use, the user should check that utensils are suitable for use in the oven.
24. When heating liquids, e.g. soup, sauces and beverages in your oven, overheating the liquid beyond boiling point can occur without evidence of bubbling. This could result in a sudden boil over the hot liquid. To prevent this possibility the following steps should be taken:
 - a) Avoid using straight-sided containers with narrow necks.
 - b) Do not overheat.
 - c) Stir the liquid before placing the container in the oven and again halfway through cooking time.
 - d) After heating, allow to stand in the oven for a short time, stirring again before carefully removing the container.
25. When heating food in plastic or paper containers, keep an eye on the oven due to the possibility of ignition.

●Always follow “Types of Container to Use”. (p.10)
26. The oven is intended for heating food and beverages. Drying of food or clothing and heating of warming pads, slippers, sponges, damp cloth and similar may lead to risk of Injury, ignition or fire.
27. Eggs in their shell and whole hard-boiled eggs should not be heated in ovens since they may explode, even after microwave heating has ended.
28. This oven can be used by children aged from 8 years and above and persons with reduced physical, sensory or mental capabilities or lack of experience and knowledge if they have been given supervision or instruction concerning use of the oven in a safe way and understand the hazards involved. Children shall not play with the oven. Cleaning and user maintenance shall not be made by children without supervision.
29. The oven should not be cleaned with a water jet.
30. The oven should not be cleaned with a steam cleaner.

Important Safety Instructions

31. Electromagnetic fields can present a possible danger. We would recommend that people using a heart pacemaker avoid proximity to these fields.
32. When the oven is not in use, it is recommended that items are removed. If left inside and the switch is accidentally activated, there is potential for damage to occur.
33. During service and/or replacement of parts, the oven should be disconnected from the power supply. Once the plug is removed, it should remain visible to the service operator to avoid inadvertent reconnection.
34. The oven should be cleaned regularly and any food deposits removed.
35. Do not heat with oil from the leftover food or the food left in the accessories in the oven cavity. Doing so may generate sparks and cause fire or smoking.
36. Failure to maintain the oven in a clean condition could lead to deterioration of the surface that could adversely affect the life of the appliance and possibly result in a hazardous situation.
37. Do not use metalware, ceramics trimmed with gold or silver, or any container with a metal content when cooking with the microwave. **ONLY THE PROVIDED WIRE RACK CAN BE USED.**
38. It is recommended to use personal protection equipment in case of spreading hot food stuff.
39. Exterior oven surfaces, including air vents on the cabinet and the oven door will get hot during use. Take care when opening or closing door and when inserting or removing food and accessories.
The oven has heaters situated in the top and back of the oven.
After use, the roof, walls and floor will be very hot.
40. Take caution when removing the hot accessories after cooking. It may cause burn. Use oven gloves.
41. Take caution when rapidly cooling the hot accessories after cooking. It may cause burn with steam or airborne droplets. It may also cause injury by the accessories breaking.
42. It is essential reheated food is served "piping hot". Always check before serving and if in doubt return food to oven for further heating.
All temperatures provided are for guidance only. Local legislation of food temperature requirements should be applied, to ensure a safe temperature has been reached before serving any food.
43. The standing time is essential for foods cooked or reheated by CONVECTION-AND-MICROWAVE, or GRILL-AND-MICROWAVE. During the standing time, heat will continue to conduct to the centre to cook the food completely.
The denser the food, the longer the standing time. Reheated foods also require a standing time.

44. Follow specific instructions in this guide for proper use of oven accessories and cookware. Failure to do so could damage the oven. Take care when removing food and/or accessories from the oven.
45. When the oven has finished operating, the fan motor will continue to rotate in order to cool the electric components. This is normal and food can still be removed from the oven during this cooling period. Do not remove the plug or turn off the breaker.

USING YOUR OVEN

Do not store any objects inside the oven in case it is accidentally turned on. In case of electronic failure, the oven can be turned off at wall outlet.

MAINTENANCE OF YOUR OVEN

If your oven should require a service, please contact +44 344 844 3899 (UK) / +353 012 898 333 (IR) and we will provide details of an appropriate service agent. Do not attempt to make any adjustments or repairs to any part of the oven. (Phone numbers are subject to change without notice.)

WARRANTY: 12 months on-site warranty for the United Kingdom is included in the purchase price of this product.

WHEN THE HEATER IS TURNED ON FOR THE FIRST TIME

You may detect smoke or a harsh odour. This is normal and is caused by the burning off of the oil that is used to protect the oven cavity.

You may prefer to perform a blank baking as described below if you find this unpleasant;

1. Place the supplied Base Plate Liner, Ceramic Tray and Wire Rack into the oven. (p.17)
 2. Select **Manual** and preheat the oven at 280°C for 20 minutes. (p.28)
 3. Once this operation is completed, open then close the door and press the Stop/Reset pad to return to the initial screen.
- Always ventilate when performing a blank baking.
 - There is no food sanitation issues even if you use the oven without performing a blank baking first.

Panasonic Corporation makes no warranties of any kind, either express or implied, including but not limited to warranties of merchantability, fitness for a particular purpose, of title, or of non-infringement of third party rights. Use of the product by a user is at the user's risk. All cooking settings are for guidance only and should be altered depending on the initial state, temperature, moisture and type of food. Depending on the characteristics of the food, cooking times and power levels may need to be adjusted. Prior to service of food ensure it has reached a safe temperature.

Types of Container to Use

CONVECTION-AND-MICROWAVE/ GRILL-AND-MICROWAVE

As these programmes use microwaves and heat (CONVECTION or GRILL), you must choose the container carefully.

DO USE: Ceramics, Heat Resistant glass eg. Pyrex®

- As for metal, ONLY THE PROVIDED WIRE RACK CAN BE USED.

DO NOT USE:

Plastics, Cling film, Metal, Metal skewers, Aluminum foils, Silicon, Lacquerware, Glass without heat resistance, Paper, Wood, Wicker

CONVECTION/GRILL/CONVECTION-AND-GRILL

DO USE: Ceramics, Heat Resistant glass eg. Pyrex®, Metal, Metal skewers, Aluminum foil

DO NOT USE:

Plastics, Cling film, Silicon, Lacquerware, Glass without heat resistance, Paper, Wood, Wicker

MICROWAVE

- You can use microwave only cooking at Step 2 and Step 3 in Cooking in Steps. (pp.34–35)

DO USE: Ceramics, Heat Resistant glass eg. Pyrex®, Plastics/Cling film/Silicon with heat resistance of 180°C or higher

- As for metal, ONLY THE PROVIDED WIRE RACK CAN BE USED.
- You can not use any dish with METAL PATTERN or TRIM.

DO NOT USE:

Metal, Metal skewers, Aluminum foil, Plastics with heat resistance less than 180°C, Polyethylene, Melamine, Phenol, Urea resin, Lacquerware, Glass without heat resistance, Paper, Wood, Wicker

- Please observe the heatproof temperature described in the package when using heat-resistant cooking sheet or parchment paper, etc.

Cooking Modes

How to Cooking

Convection

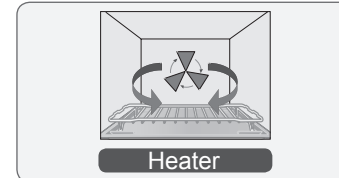

Grill

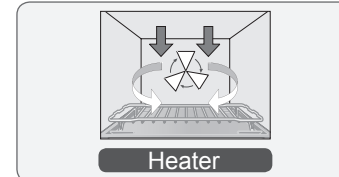

Convection-and-Grill

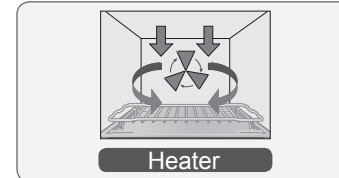

Microwave

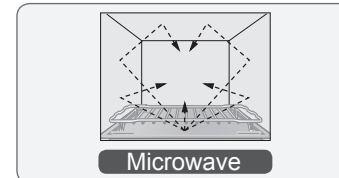

Convection-and-Microwave

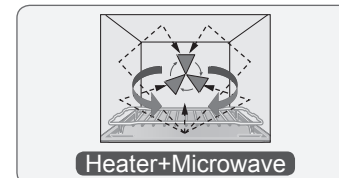

Grill-and-Microwave

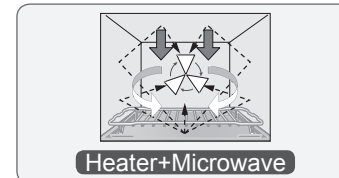

Cooking Modes

A convection heater (circulation fan heater) circulates heat throughout the oven cavity and cooks food fully while controlling the set temperature. (p.29)

A grill heater provides heat and a circulation fan operates to distribute the heat throughout the oven cavity. Every surface of the food is well-cooked. (p.30)

Both convection heater (circulation fan heater) and grill heater circulate heat in the oven cavity while controlling the temperature. Cooks the food throughout while browning on the surface. (p.31)

- You can use microwave only cooking at Step 2 and Step 3 in Cooking in Steps. (pp.34–35)

Applies microwaves to the food causing the molecules in the food to strongly collide and give rise to heating by friction. As a result, the food is heated about the same on the surface and inside.

Combined cooking with convection heater (circulation fan heater) and microwave. A convection heater circulates heat throughout the oven cavity with controlling the set temperature while the microwave heats the food fully. The cooking time is reduced. (p.32)

Combined cooking with grill heater and microwave. A grill heater adds heat while a microwave heats the food, and additionally a circulation fan operates to give the entire surface a crisp finish. The cooking time is reduced. (p.33)

- Illustrations are images. The accessories to be used differ depending on the cooking mode.

About the arrows in the illustration



Convection Heater



Grill Heater



Fan only



Microwave

Basic Usage

You can cook in a cooking mode suitable for the application.

Select **Memory** or **Manual**

Manual cooking

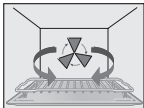
Convection

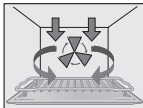
 (p.29)
 Heater

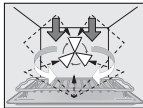
Convection-and-Grill

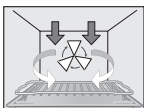
 (p.31)
 Heater

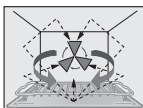
Grill-and-Microwave

 (p.33)
 Heater+Microwave

Grill

 (p.30)
 Heater

Convection-and-Microwave

 (p.32)
 Heater+Microwave

- Microwave only cooking is not possible in Step 1.

- Illustrations are images. The accessories to be used differ depending on the cooking mode.

Fan Speed

- The fan circulates the heat of the heater throughout the entire oven to brown food and give a crisp finish to the surface.
- The fan speed can be set from 30% to 100% when cooking other than the microwave. Adjust it depending on the food.

■ **Fan speed guide**

30%	40%	50%	60%	70%	80%	90%	100%
← Bake gently →			← Dries the food quickly and makes the surface crispy →				
← Gives the surface a crispy finish →							

Cooking in steps

6 types* of cooking modes can be combined up to 3 continuous steps. *Step 1: 5 types

Step 1	ex.: Convection 280°C, Fan speed 100%, Microwave P5, 1 min	■ Maximum power and cooking time for Convection-and-Microwave/Grill-and-Microwave cooking (p.34)
Step 2	ex.: Microwave P4, 50 sec	
Step 3	ex.: Grill High, Fan speed 30%, 30 sec	

⋮

Saving a cooking programme to the memory

Up to 100 kinds (default setting) of cooking programmes can be saved to the memory.
 [You can also set 10 kinds or 1000 kinds. (p.40)]
 The saved cooking programme can be used to achieve the same cooking. (p.41)

Cooking Chart

Cooking time is just a guide. Adjust depending on the kind of food and the start temperature.

- This oven is designed for reheating already cooked foods.
- Panasonic Corporation makes no warranties of any kind, either express or implied, including but not limited to warranties of merchantability, fitness for a particular purpose, of title, or of non-infringement of third party rights. Use of the product by a user is at the user's risk. All cooking settings are for guidance only and should be altered depending on the initial state, temperature, moisture and type of food. Depending on the characteristics of the food, cooking times and power levels may need to be adjusted. Prior to service of food ensure it has reached a safe temperature. Oil from the food may cause failure.
- Please set the provided Base Plate Liner, Ceramic Tray, Wire Rack and additionally other accessories suitable for the intended cooking mode in the oven before starting preheating, except Oven Sheet and Paddle.
- If the fan speed is high, foods on the surface may be scattered. In this case, please lower the fan speed.
- Refer to "Accessories" (p.16) for details on how to use the accessories before cooking.

■ Reheat

Menu	Start Temp.	Quantity (Weight)	Accessory/ Other Utensil	Preheat Temp.	Programme						
					Step	Conv	Fan	Grill	MW	Time	Total Time
Toast	Room temp.	2 slices (55 g each)	Ceramic Plate (white)/ Parchment Paper	280°C	1	OFF	100%	HIGH	OFF	50 sec	50 sec
Toasted bagel	Room temp.	1 slice (80 g)	Ceramic Plate (white)/ Oven Sheet	280°C	1	OFF	100%	HIGH	P6	40 sec	40 sec
Croissant	Room temp.	1 piece (70 g)	Ceramic Plate (white)/ Oven Sheet	280°C	1	OFF	80%	LOW	P8	20 sec	20 sec
Panini	Chilled	1 piece (170 g)	Ribbed Plate (black)/ Parchment Paper	280°C	1	280°C	80%	OFF	P6	55 sec	1 min 5 sec
					2	OFF	100%	LOW	P4	10 sec	
Toastie	Chilled	1 piece (170 g)	Ribbed Plate (black)/ Parchment Paper	280°C	1	OFF	100%	LOW	P8	1 min 5 sec	1 min 15 sec
					2	OFF	100%	HIGH	P4	10 sec	
Croque monsieur	Chilled	1 piece (190 g)	Ceramic Plate (white)/ Oven Sheet	280°C	1	OFF	100%	HIGH	P6	30 sec	1 min
					2	OFF	100%	HIGH	P4	30 sec	
8" Pizza	Frozen	1 piece (335 g)	Ceramic Plate (white)/ Parchment Paper	280°C	1	OFF	100%	LOW	P8	1 min	2 min 20 sec
					2	OFF	100%	HIGH	P4	1 min 20 sec	
	Chilled	1 piece (300 g)	Ceramic Plate (white)/ Parchment Paper	280°C	1	OFF	80%	LOW	P8	1 min	1 min 45 sec
					2	OFF	90%	HIGH	P4	45 sec	
Cornish Pasty	Chilled	1 piece (130 g)	Ceramic Plate (white)/ Oven Sheet	280°C	1	220°C	80%	OFF	P6	1 min 30 sec	1 min 30 sec

Menu	Start Temp.	Quantity (Weight)	Accessory/ Other Utensil	Preheat Temp.	Programme						
					Step	Conv	Fan	Grill	MW	Time	Total Time
Cottage/ Shepherds Pie	Chilled	1 serv. (300 g)	Ceramic Plate (white)/ Oven Sheet	280°C	1	OFF	100%	LOW	P8	2 min	2 min 50 sec
					2	280°C	100%	OFF	P4	50 sec	
Meat pie	Chilled	1 piece (250 g)	Ceramic Plate (white)/ Oven Sheet	280°C	1	220°C	40%	OFF	P6	2 min	3 min
					2	220°C	40%	OFF	P4	40 sec	
					3	220°C	40%	OFF	OFF	20 sec	
Quiche (slice)	Chilled	1 piece (100 g)	Ceramic Plate (white)/ Oven Sheet	280°C	1	280°C	100%	OFF	P6	30 sec	1 min
					2	280°C	100%	OFF	P4	30 sec	
Pasta Bake/ Macaroni Cheese	Chilled	1 serv. (300 g)	Ceramic Plate (white)/ Oven Sheet	280°C	1	OFF	100%	LOW	P8	2 min	2 min 50 sec
					2	280°C	100%	OFF	P4	50 sec	
Sausage roll	Chilled	1 piece (135 g)	Ceramic Plate (white)/ Oven Sheet	280°C	1	OFF	100%	LOW	P8	50 sec	50 sec
Wrap	Chilled	1 piece (165 g)	Ceramic Plate (white)/ Oven Sheet	280°C	1	OFF	90%	LOW	P8	1 min 10 sec	1 min 10 sec
Waffles	Room temp.	2 pieces (25 g each)	Ceramic Plate (white)/ Oven Sheet	280°C	1	OFF	50%	LOW	P8	25 sec	25 sec
Apple Pie (slice)	Chilled	1 piece (140 g)	Ceramic Plate (white)/ Oven Sheet	280°C	1	280°C	100%	OFF	P6	45 sec	45 sec
Pain au chocolate	Room temp.	1 piece (65 g)	Ceramic Plate (white)/ Oven Sheet	280°C	1	OFF	80%	LOW	P7	20 sec	20 sec
Chocolate brownie (reheat)	Chilled	1 piece (40 g)	Ceramic Plate (white)/ Oven Sheet	280°C	1	220°C	60%	OFF	P6	25 sec	25 sec

● Microwave Power Level

Display	Power	Display	Power
P8	1050 W	P3	500 W
P7	900 W	P2	300 W
P6	800 W	P1	200 W
P5	700 W	P0	0 W
P4	600 W		



WARNING

Do not over-heat food.

If the heating time is too long for the amount of food, there is a danger of fire or smoke.

- When heating, always start with minimum cooking time and heat while keeping an eye on the progress.
- In particular, take care when heating small amounts, oily or fatty foods or liquids, or sweet potatoes and other root vegetables.

Accessories

● To purchase accessories, please contact the dealer or a service agent. (p.49)
Take care when handling Ceramic Tray, Ribbed Plate and Ceramic Plate as they are breakable. If they are damaged, stop using them and contact the dealer or a service agent.

Base Plate Liner **Ceramic Tray** **Wire Rack** **Paddle**

Ribbed Plate (black) **Ceramic Plate (white)** **Oven Sheet (3 colors)** **Specified SD Memory Card**

Always install Base Plate Liner, Ceramic Tray and Wire Rack before use.

● Set in the main unit when shipped from the factory. (p.50)

■ Procedure to attach the Base Plate Liner

Use the Base Plate Liner to prevent the food and oil stains on the bottom surface of the oven cavity .

- ① **After removing the Base Plate Liner from the packaging, turn it over and bend it along the left and right bend lines.**
(Bend the Base Plate Liner in the opposite direction to the orientation when removed from the packaging.)

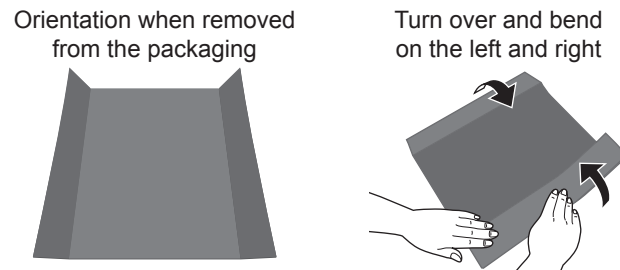

- ② **Remove all the accessories from the oven, insert the bent Base Plate Liner up to the inside of the oven cabinet, and ensure that it is in close contact with the inside of the oven cabinet.**
(Ensure close contact so that there is no gap between the inner side of the oven and the Base Plate Liner. If there is a gap, oil, etc. will collect there.)

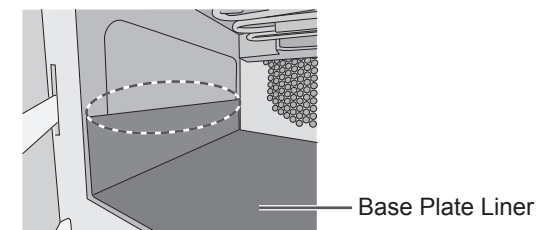

- ③ **Place the Ceramic Tray, Wire Rack, and accessories required for cooking on the Base Plate Liner in that order.**

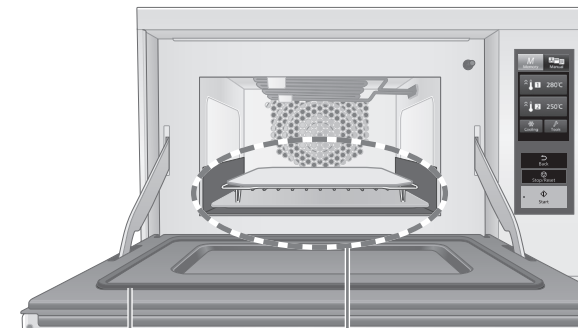
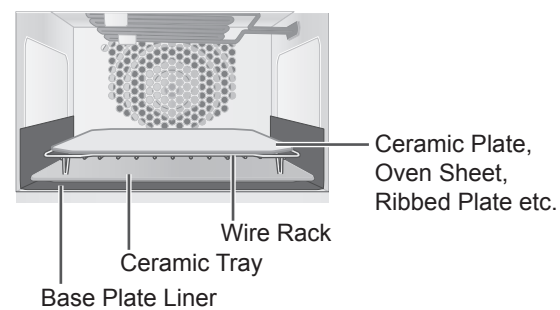

There is a seam in the door seal, which is not a damage.

⚠ CAUTION

The oven shall not be operated by microwave without food in the oven.

Doing so may cause the oven to become abnormally hot due to sparks and the red-hot inner bottom surface. This may cause a risk of burns.

- Also, do not operate the oven only with containers, and the provided accessories.
- Take care not to burn yourself when removing any accessories from the oven after cooking. Use oven gloves.

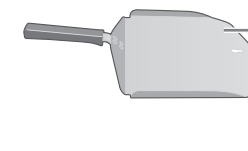

Paddle
Use when removing Oven Sheet or foods. Do not use for removing the other accessories. Do not allow to contact acidic or alkaline foods for a long time.

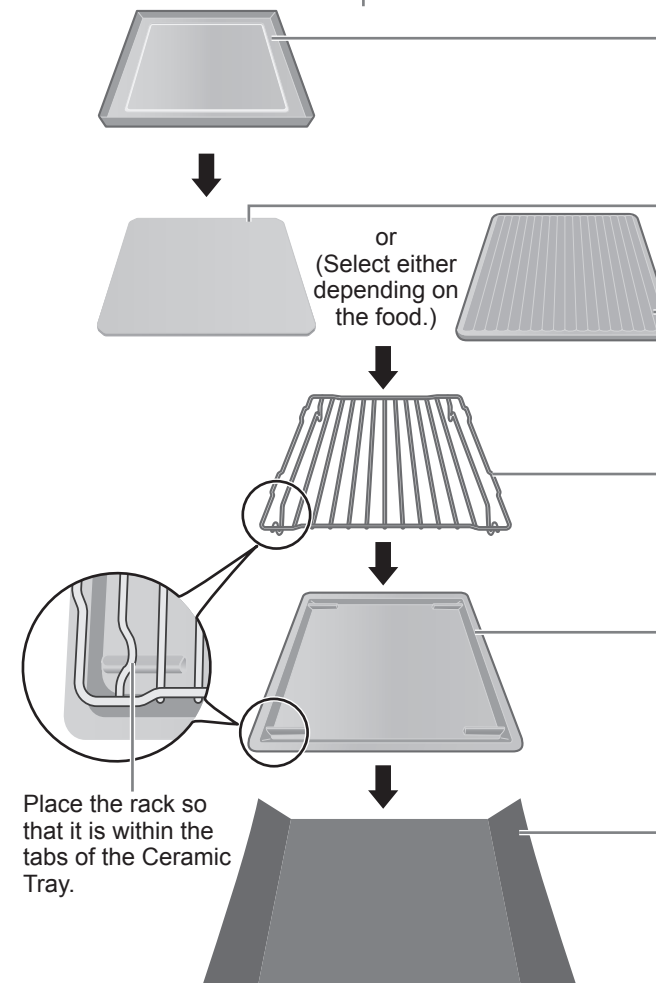

Oven Sheet (3 colors)
Place on the Ceramic Plate only. Do not place on the Ribbed Plate. Place food on the Oven Sheet.
● It is recommended to replace it every 3 to 6 months depending on the stain level.

Ceramic Plate (white)
Place on the Wire Rack. Place food on the Ceramic Plate.

Ribbed Plate (black)
Place on the Wire Rack. Place food on the Ribbed Plate.
● Be sure to use the ribbed plate with the ribs upward and oriented like illustration.

Wire Rack
Place on the Ceramic Tray.

Ceramic Tray
Place on the Base Plate Liner. Use as a drip tray for the food.

Base Plate Liner
Place on the bottom surface of the oven. Use to prevent the food and oil stains.
● It is recommended to replace it every 3 to 6 months depending on the stain level.

● Illustrations may differ to the actual items.

Parts of your Oven

Front

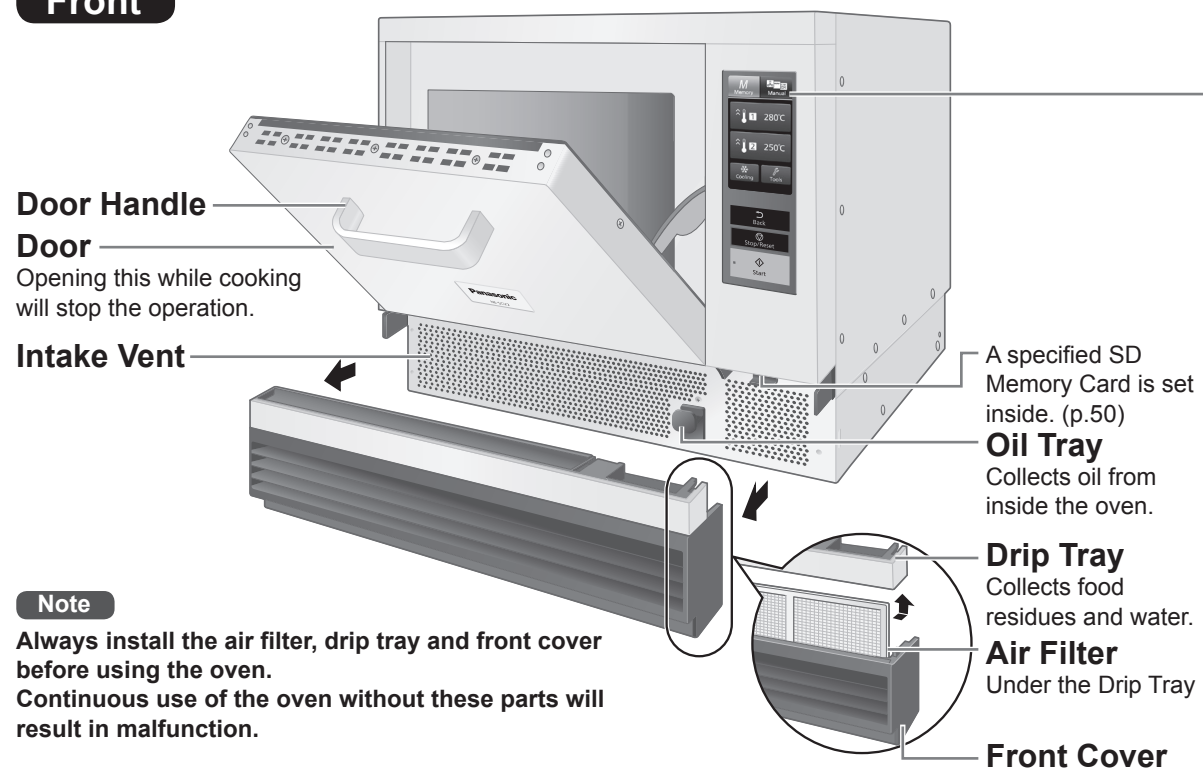

Note

Always install the air filter, drip tray and front cover before using the oven. Continuous use of the oven without these parts will result in malfunction.

Back

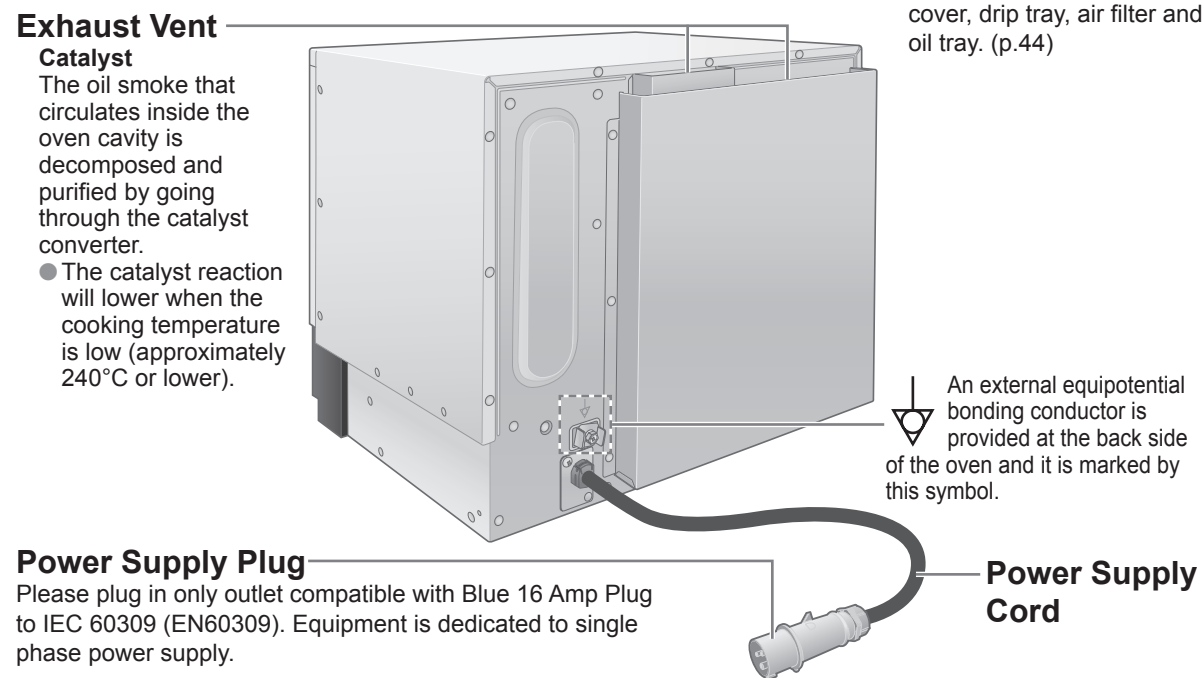

● Illustrations may differ to the actual items. Caution labels are affixed to the actual oven.

EARTHING

IMPORTANT: FOR PERSONAL SAFETY, THIS OVEN MUST BE PROPERLY EARTHED. When an outlet is not earthed, it is personal responsibility and obligation of the customer to have it replaced with a properly earthed outlet.

Control Panel (initial screen)



Touch Screen (display) (p.21)

- Tap on the screen directly to use the controls.
- Shows details such as the cooking temperature, cooking time, stored cooking programme, beep information, and so on.
- Do not touch the screen with a sharp object. Doing so will cause damage.

Cooling (p.22)

Tools (pp.23-27)

Back Pad

- Returns to the previous control screen so that settings can be changed.
- Unavailable after cooking has started.

Stop/Reset Pad

- Press once to temporarily stop the cooking process. To resume cooking, press the Start pad.
- Press twice to clear your instructions (returns to the initial screen) or cancel cooking.

Lamp

Start Pad

- After setting preheating or cooling, press this pad.
- After preheating, setting memory cooking or manual cooking and press this pad to start cooking.
- The lamp will flash to encourage you to press the pad.

■ Auto Power OFF Function

The initial screen of the display turns off automatically if it is not used for 5 minutes.

■ To turn the power ON

In Auto Power OFF mode, opening the door turns the power ON.

Instruction for Stacking

Oven can be stacked up to two ovens by fixing with the Panasonic joint plate (Foot Bracket/A11343G80BP). The joint plate is an optional item. Contact the dealer or a service agent. (p.49) Request the installation to an electric constructor. (The construction cost is not included in the price of the oven.)

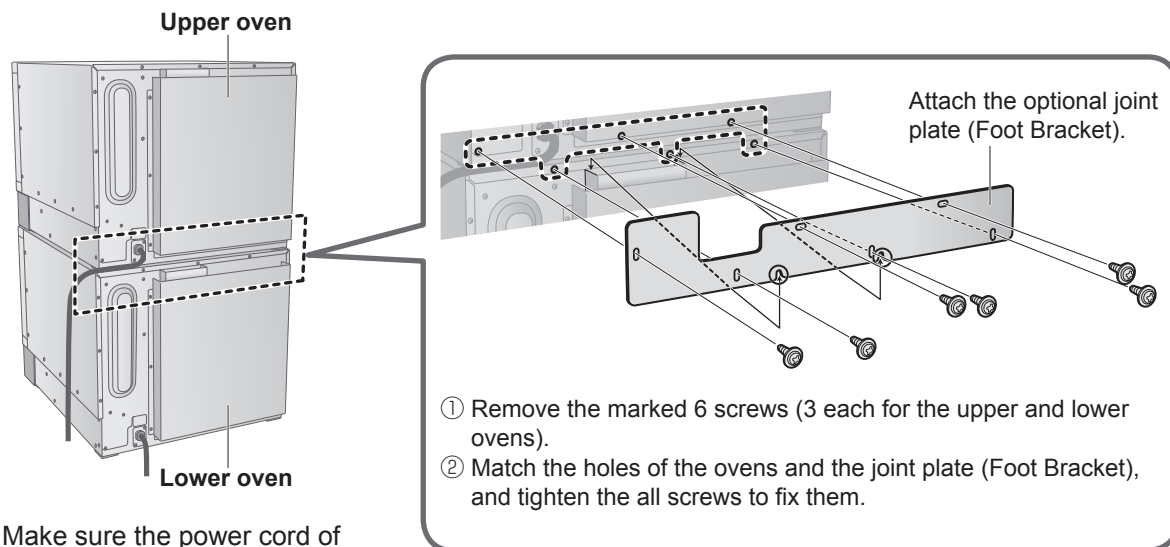

Make sure the power cord of the upper oven will not block the exhaust vent of the lower one.

● Please keep the separation distance below.

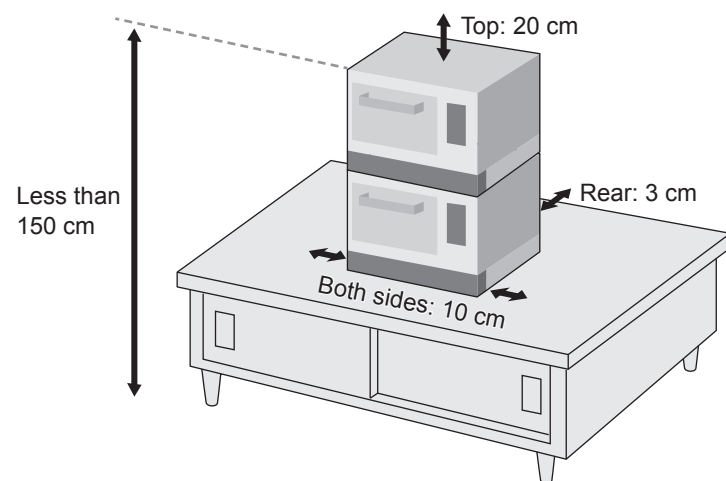

WARNING

Do not install the oven at 150 cm or more above the floor. Doing so may result in danger of burns. Only a combination of same models are allowed when stacking.

CAUTION

Disconnect the power cord from the wall outlet before installation and be sure the oven cavity is empty. It may cause electric shock or injury.

How to Operate the Touch Screen

Memory

When cooking with the stored heating programme → “Cooking with a Saved Cooking Programme” (p.41)



● The **Memory** cooking screen is the initial screen.

● You can change the preheat temperature. (p.25)

● Approximate preheating time; 280°C: 10 min. 250°C: 9 min.

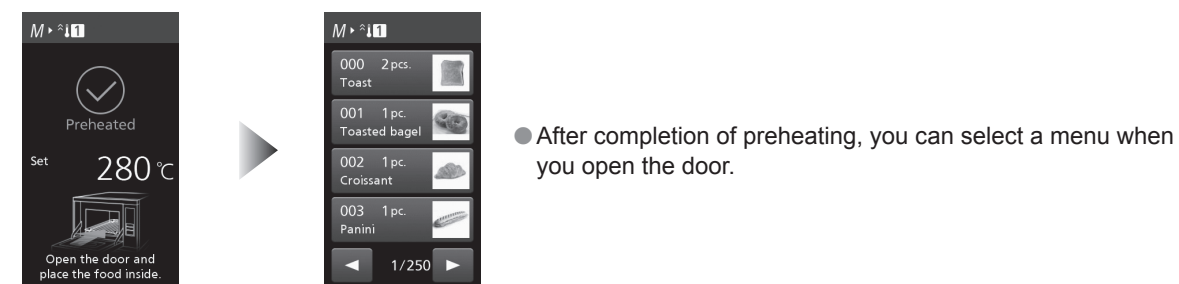

● After completion of preheating, you can select a menu when you open the door.

Manual

When cooking manually → “Manual Cooking” (pp.29–35)



● Select **Manual**.

● You can change the preheat temperature. (p.25)

● Approximate preheating time; 280°C: 10 min. 250°C: 9 min.

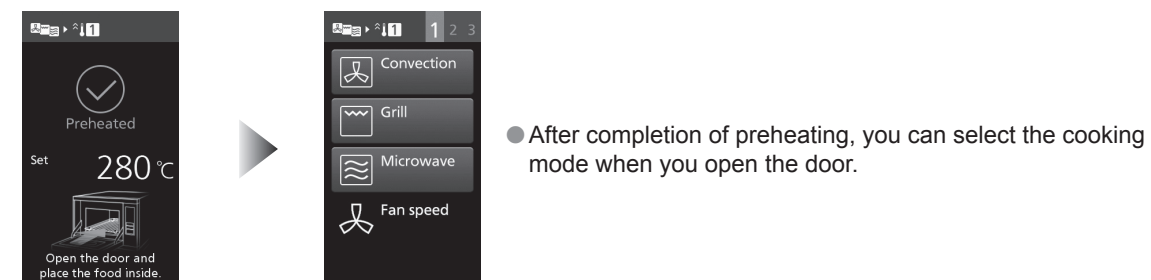

● After completion of preheating, you can select the cooking mode when you open the door.

How to Operate the Touch Screen

Cooling

The inside of the oven can be cooled when the cavity is hot after cooking.

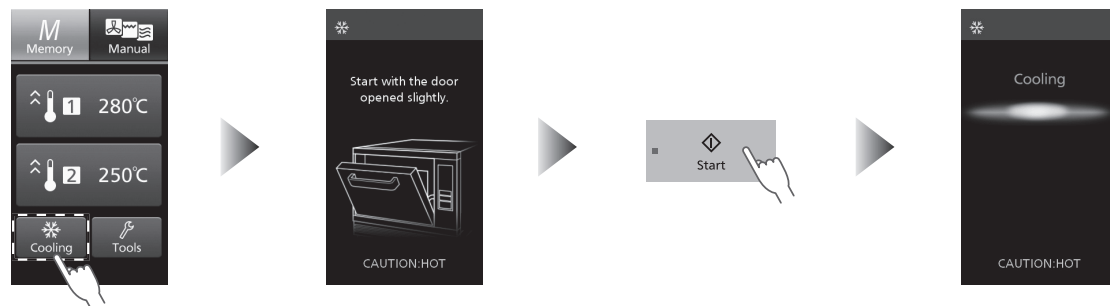

- Open the door slightly to lock it in place. (Keep your face away.)

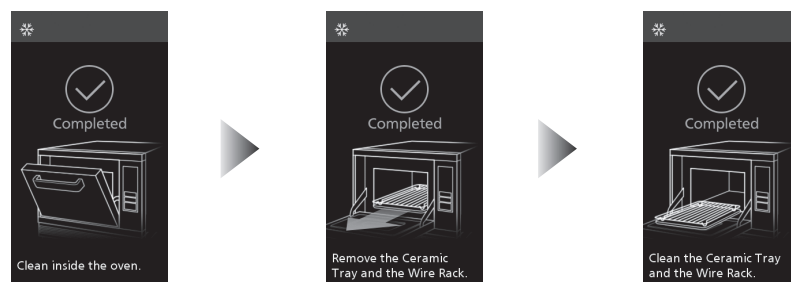

- The cooling time depends on the temperature inside the oven. (up to 45 minutes)

CAUTION
Take care of hot air when opening the door.

Tools

You can change and confirm various settings, such as memory or beep.

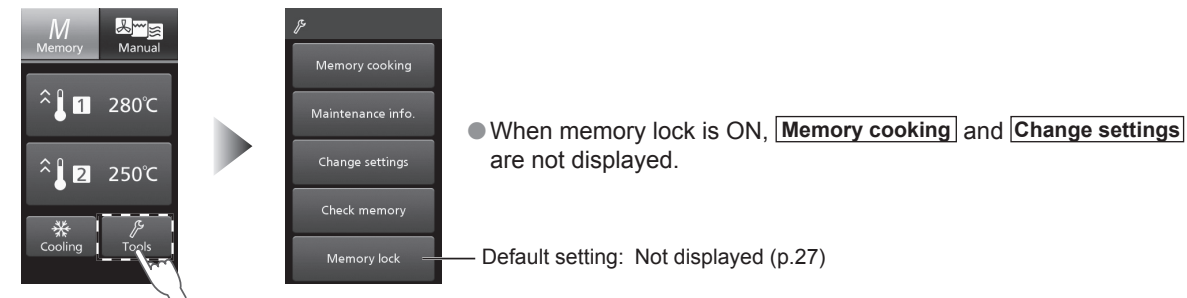

- When memory lock is ON, **Memory cooking** and **Change settings** are not displayed.

Default setting: Not displayed (p.27)

Memory cooking

- This feature cannot be used when memory lock is ON. Please cancel memory lock. (p.27)

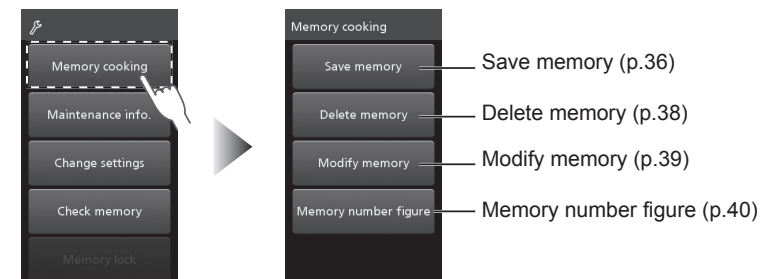

Save memory (p.36)

Delete memory (p.38)

Modify memory (p.39)

Memory number figure (p.40)

Maintenance info.

■ To review the all cooking hours (including preheating)

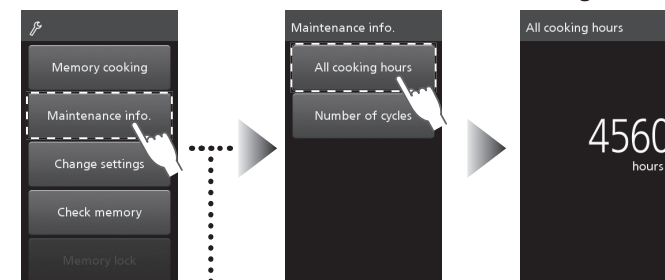

Notes

- The highest figure of the counter is 999999 hours. It returns to "0" the next time it is used.
- A total of all cooking hours is rounded down to the nearest hour.

ex.)

All cooking hours	Display
59 min	0
1 hr 59 min	1

- Returns to the initial screen after 3 seconds.

■ To review the number of cycles (including preheating)

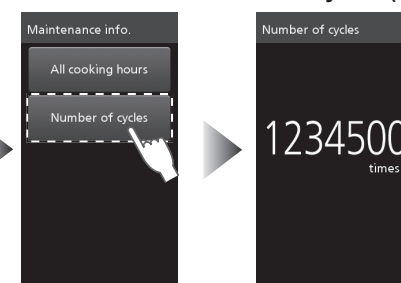

Notes

- The highest figure of the counter is 3999999 times. It returns to "0" the next time it is used.
- If you start cooking again after a pause in the middle, it also counts as a new cycle.
- The last two figures of the total number of cycles are rounded down.

ex.)

Number of cycles	Display
99 times	0
101 times	100
1100 times	1100

- Returns to the initial screen after 3 seconds.

How to Operate the Touch Screen

Tools

Change settings

- This feature cannot be used when memory lock is ON. Please cancel memory lock. (p.27)

Beep

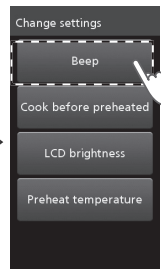
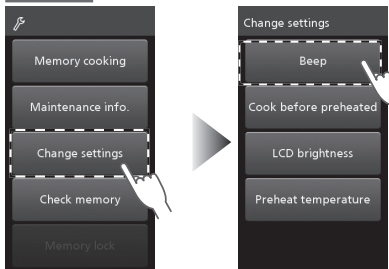

To change the loudness of the beep

(Default setting: Level3)

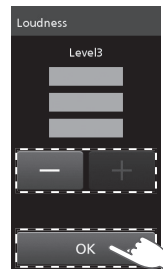
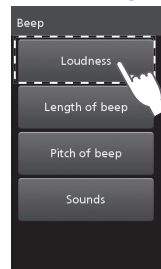

- Depending on the setting, **Pitch of beep clean** may be displayed.
- Select the loudness with **+** or **-**, and tap **OK**.

To change the length of beep at the end of programme

(Default setting: Type1)

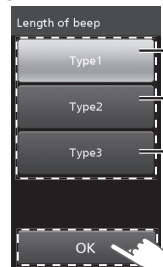
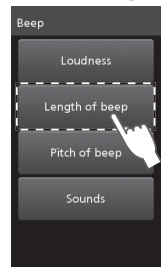

- Type1 — Beeps in three short pulses every 15 seconds
- Type2 — Beeps in longer pulses continuously
- Type3 — Beeps in one long pulse then beeps in three longer pulses every 30 seconds
- The beep stops when you open the door.

- Select the length of beep and tap **OK**.

To change the tone pitch of the beep at the end of programme

(Default setting: Normal)

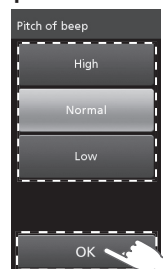
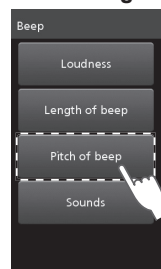

- Select the tone pitch and tap **OK**.

To select ON or OFF for the preheated beep (Default setting: ON)

To select ON or OFF for the door alarm (Default setting: ON)

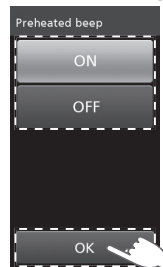
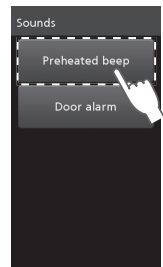
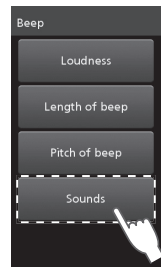

- Select **Preheated beep** or **Door alarm**.
- Select **ON** or **OFF**, and tap **OK**.

- The oven returns to the initial screen after displaying the settings for 3 seconds.

Cook before preheated

- ON: You can start cooking before preheating is complete.
- OFF: You cannot start cooking until preheat is complete. (Default setting: OFF)

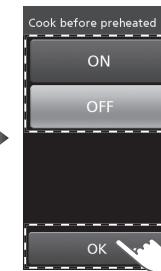
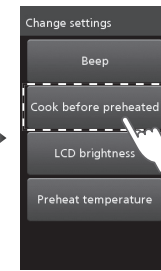
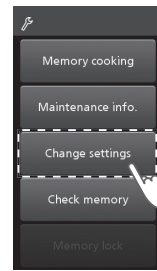

Note

- If you choose **ON** to start cooking during preheating, the cooking results may be affected because the oven cavity temperature may be low.

- Select **ON** or **OFF**, and tap **OK**.
- The oven returns to the initial screen after displaying the settings for 3 seconds.

LCD brightness

You can choose the brightness of the touch screen.

(Default setting: Level3)

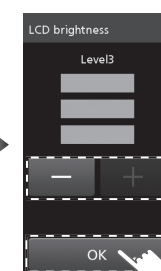
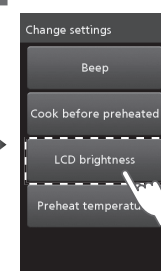
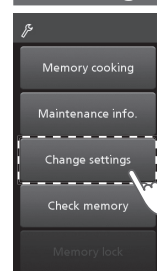

Bright
Dark

- The oven returns to the initial screen after displaying the settings for 3 seconds.

- Select the brightness with **+** or **-**, and tap **OK**.

Preheat temperature

You can change the preheat temperature displayed on the initial screen.

(Default setting: Preheat 1 → 280°C, Preheat 2 → 250°C)

- Please note that the preheat temperature previously saved for the memory cooking (p.36) will also be changed if you change the setting here.

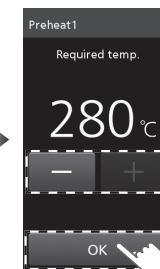
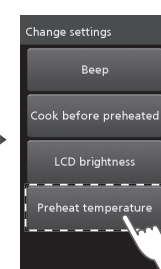
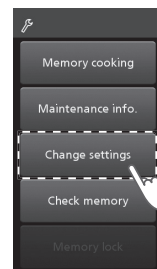

- Select **Preheat1** or **Preheat2**.

- Set Required temp. From 180°C to 280°C in 10°C increments

- Set Cook available temp. From 180°C to 280°C in 10°C increments



- Returns to the initial screen after 3 seconds.

Notes

- You can start cooking at temperature set at **Cook available temp.** when **Cook before preheated** is set to **ON**. If the **Cook before preheated** is set to **OFF**, **Cook available temp.** setting will be skipped.

How to Operate the Touch Screen

Tools

Check memory

Memory list Saved cooking contents, beep, and memory lock setting, etc. are displayed in order every 4 seconds.

Memory cooking contents
(In the case of two-digit display: 00–99)
(pp.36–37)

No. 00	1 2 3	No. 00	1 2 3	No. 00	1 2 3
Convection	280°C	Convection	OFF	Convection	OFF
Grill	OFF	Grill	OFF	Grill	OFF
Microwave	P6	Microwave	P4	Microwave	P2
Fan speed	100%	Fan speed	OFF	Fan speed	OFF
Time	2m 00s	Time	1m 00s	Time	30s
Change number		Change number		Change number	

- To call up a particular memory number to confirm, see below.

Beep settings (p.24) Memory lock (p.27) Magnetron interval (p.45) Maintenance interval (p.45)

- Returns to the initial screen.

● In order to call up a particular memory number to confirm, press the Stop/Reset pad while the display is changing, then tap **Change number**, enter the memory number and tap **OK**. The memory contents are displayed by pressing the Start pad.
(ex.: To call up memory number 52)

Continues to display the contents of subsequent memory numbers.

SD Checksum

Use to confirm whether the contents of multiple SD Memory Cards are the same. The memory contents in the SD Memory Card are displayed as four-figure alphanumeric characters. If the alphanumeric characters are the same, the memory contents of those SD Memory Cards are the same.

■ To confirm the memory cooking data (ex.: BBE4)

- Returns to the initial screen after 3 seconds.

■ To confirm the beep, memory lock data etc. (ex.: 01D1)

- Since the screen changes quickly, it is hardly possible to catch up the above screen.
- Returns to the initial screen after 3 seconds.

Memory lock

You can choose memory lock ON or OFF.

● **Memory lock** needs to be set every time.

(Default setting: OFF)

- The oven returns to the initial screen after displaying the settings for 3 seconds.
- Select **ON** or **OFF**, and tap **OK**.
- Press Start pad for 2 seconds (beeping), and press Start pad 3 times (beeping).

Notes

■ When the memory lock is ON

- Memory cooking starts automatically after you select a memory number even without pressing the Start pad.
- **Memory cooking** and **Change settings** are not displayed.

■ When the memory lock is OFF

- Memory cooking starts when you press the Start pad after entering the memory number.

Preheating

Use the preheating function to warm up the oven in advance.

1 280°C and 2 250°C are set as default.

Preheating will resume automatically every time cooking has finished once the preheating has been set.

- Set the provided Base Plate Liner, Ceramic Tray, Wire Rack and other accessories suitable for the intended cooking mode, in the oven before starting preheating, except Oven Sheet and Paddle.

(ex.: Memory, 1 280°C)

1 Select 1 280°C



2 Press the Start pad

- Pausing or opening and closing the door during preheating will automatically resume preheating after 10 seconds.



3 Preheating has been completed

- Approximate preheating time:
280°C: 10 min.
250°C: 9 min.



- The default setting is that the beep sounds after preheating is complete. After putting the food into the oven, close the door immediately and set memory cooking (p.41) or manual cooking (pp.29–35).
- You can turn off the beep.
“To select ON or OFF for the preheated beep” (p.24)
- If you leave the door open during preheating or after preheating has completed, the beep sounds after 30 seconds and 50 seconds.
- If the **Cook before preheated** is set to **OFF** and you leave the door open for 1 minute or more after preheating is complete, the oven cavity temperature will drop so cooking cannot be started. Close the door, press the Start pad and preheat again.
- If the **Cook before preheated** is set to **ON**, you can start cooking during preheating.
“Cook before preheated” (p.25)
- If the pads are not used after preheating is complete, preheating will be cancelled after 4 hours.

- **To cancel preheating**
Press the Stop/Reset pad twice.

Manual Cooking

Convection Cooking

(ex.: Manual, Preheating 280°C, Convection 280°C, Fan speed 100%, 10 min 30 sec)

1 After Manual preheating, select Convection

- “Preheating” (p.28)



Put the food into the oven and close the door.

2 Set the oven temperature, and tap OK

- From 180°C to 280°C in 10°C increments
- Tap **OFF** to cancel the already selected cooking process.

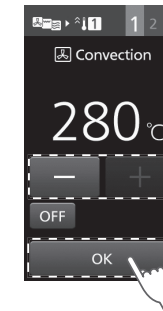

3 Set Fan speed, and tap OK

- From 30% to 100% in 10% increments
- “Fan Speed” (p.12)

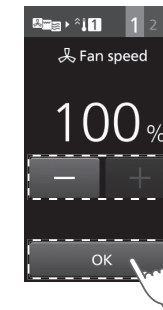

4 Tap Set time

- Tap **Convection** and **Fan speed** when changing those settings.



5 Set the cooking time

- Maximum cooking time: 30 min.
- Tap **Next** when setting Step 2.
“Cooking in Steps” (p.34)

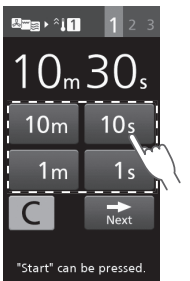

6 Press the Start pad (Cooking will start.)

- Tap **Recall** when verifying the settings for the current step.

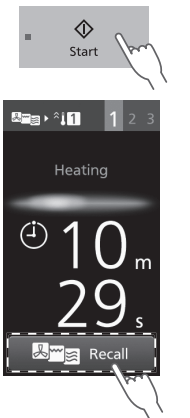

Notes

- Holding down the pad moves the temperature, fan speed, and time forward faster. This is convenient for setting a longer cooking time, and so on.
- After a cooking has finished, the cooking process can be saved into the SD Memory Card. (p.36)

Manual Cooking

Grill Cooking

(ex.: **Manual**, Preheating 280°C, Grill High, Fan speed 100%, 10 min 30 sec)

1 After **Manual** preheating, select **Grill**

- "Preheating" (p.28)



Put the food into the oven and close the door.

2 Select **High**

- Tap **OFF** to cancel the already selected cooking process.

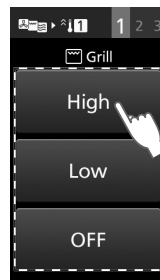

3 Set **Fan speed**, and tap **OK**

- From 30% to 100% in 10% increments
- "Fan Speed" (p.12)

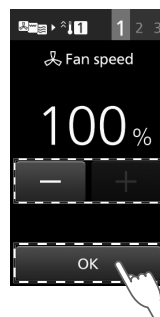

4 Tap **Set time**

- Tap **Grill** and **Fan speed** when changing those settings.



5 Set the cooking time

- Maximum cooking time: 30 min.
- Tap **Next** when setting Step 2. "Cooking in Steps" (p.34)

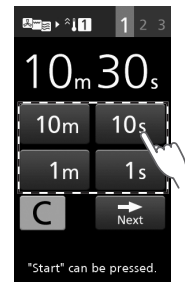

6 Press the **Start** pad (Cooking will start.)

- Tap **Recall** when verifying the settings for the current step.

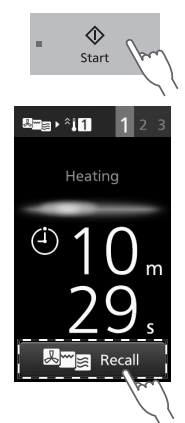

Notes

- Holding down the pad moves the temperature, fan speed, and time forward faster. This is convenient for setting a longer cooking time, and so on.
- After a cooking has finished, the cooking process can be saved into the SD Memory Card. (p.36)

Convection-and-Grill Cooking

(ex.: **Manual**, Preheating 280°C, Convection 280°C, Fan speed 100%, Grill High, 2 min 30 sec)

1 After **Manual** preheating, select **Convection**

- "Preheating" (p.28)

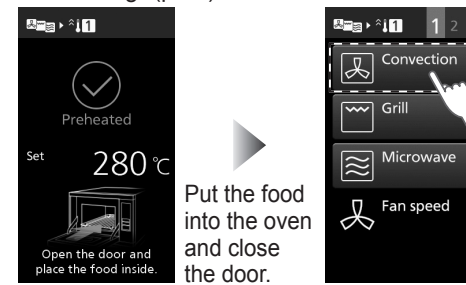

Put the food into the oven and close the door.

2 Set the oven temperature, and tap **OK**

- From 180°C to 280°C in 10°C increments
- Tap **OFF** to cancel the already selected cooking process.

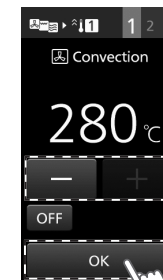

3 Set **Fan speed**, and tap **OK**

- From 30% to 100% in 10% increments
- "Fan Speed" (p.12)

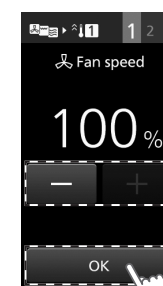

4 Select **Grill**



5 Select **High**

- Tap **OFF** to cancel the already selected cooking process.

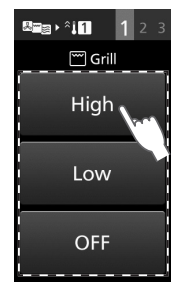

6 Tap **Set time**

- Tap **Convection**, **Grill** and **Fan speed** when changing those settings.



7 Set the cooking time

- Maximum cooking time: 30 min.
- Tap **Next** when setting Step 2. "Cooking in Steps" (p.34)

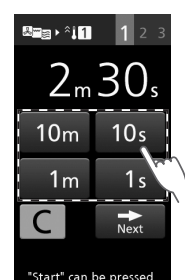

8 Press the **Start** pad (Cooking will start.)

- Tap **Recall** when verifying the settings for the current step.

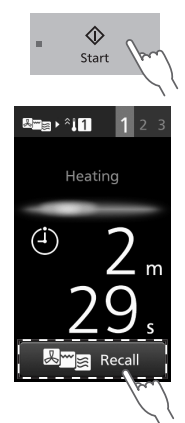

Notes

- Holding down the pad moves the temperature, fan speed, and time forward faster. This is convenient for setting a longer cooking time, and so on.
- After a cooking has finished, the cooking process can be saved into the SD Memory Card. (p.36)

Manual Cooking

Convection-and-Microwave Cooking

(ex.: **Manual**, Preheating 280°C, Convection 280°C, Fan speed 100%, Microwave P3, 1 min 30 sec)

1 After **Manual** preheating, select **Convection**

- “Preheating” (p.28)

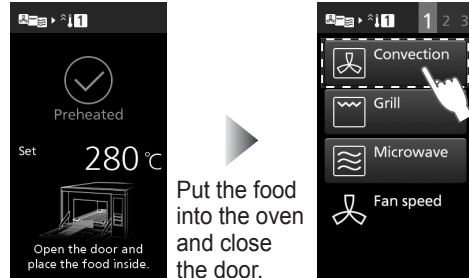

Put the food into the oven and close the door.

2 Set the oven temperature, and tap **OK**

- From 180°C to 280°C in 10°C increments
- Tap **OFF** to cancel the already selected cooking process.

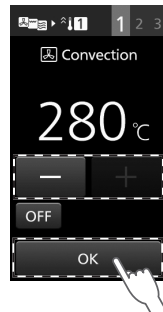

3 Set **Fan speed**, and tap **OK**

- From 30% to 100% in 10% increments
- “Fan Speed” (p.12)

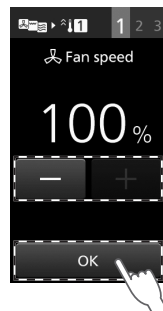

4 Select **Microwave**



5 Select the microwave power

- From P0 to P6

Display	Power	Display	Power
P6	800 W	P2	300 W
P5	700 W	P1	200 W*
P4	600 W	P0	0 W
P3	500 W		

*equivalent to 200 W

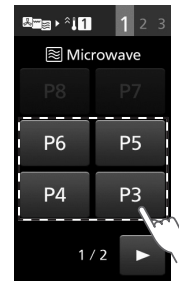

6 Tap **Set time**

- Tap **Convection**, **Microwave** and **Fan speed** when changing those settings.



7 Set the cooking time

- Maximum cooking time: 2 min.
- Tap **Next** when setting Step 2. “Cooking in Steps” (p.34)

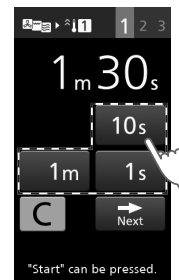

8 Press the **Start** pad (Cooking will start.)

- Tap **Recall** when verifying the settings for the current step.

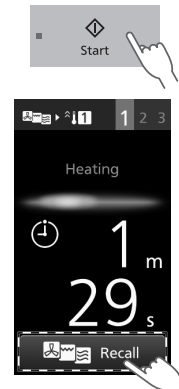

Notes

- Holding down the pad moves the temperature, fan speed, and time forward faster. This is convenient for setting a longer cooking time, and so on.
- After a cooking has finished, the cooking process can be saved into the SD Memory Card. (p.36)

Grill-and-Microwave Cooking

(ex.: **Manual**, Preheating 280°C, Grill High, Fan speed 100%, Microwave P3, 1 min 30 sec)

1 After **Manual** preheating, select **Grill**

- “Preheating” (p.28)

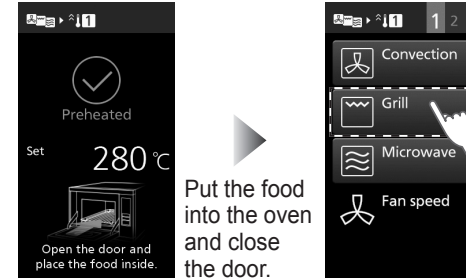

Put the food into the oven and close the door.

2 Select **High**

- Tap **OFF** to cancel the already selected cooking process.

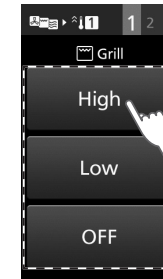

3 Set **Fan speed**, and tap **OK**

- From 30% to 100% in 10% increments
- “Fan Speed” (p.12)

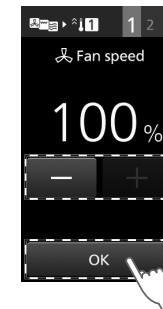

4 Select **Microwave**



5 Select the microwave power

- From P0 to P6*

Display	Power	Display	Power
P6	800 W	P2	300 W
P5	700 W	P1	200 W
P4	600 W	P0	0 W
P3	500 W		

*You can also select P7 (900 W) and P8 (1050 W) when you using Grill Low.

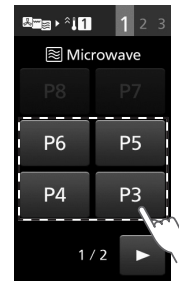

6 Tap **Set time**

- Tap **Grill**, **Microwave** and **Fan speed** when changing those settings.

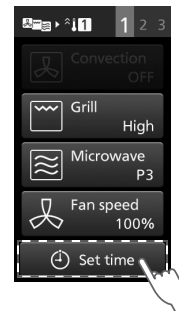

7 Set the cooking time

- Maximum cooking time: 2 min.
- Tap **Next** when setting Step 2. “Cooking in Steps” (p.34)

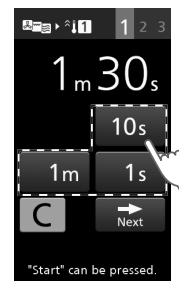

8 Press the **Start** pad (Cooking will start.)

- Tap **Recall** when verifying the settings for the current step.

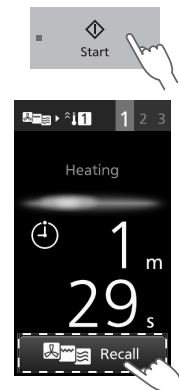

Notes

- Holding down the pad moves the temperature, fan speed, and time forward faster. This is convenient for setting a longer cooking time, and so on.
- After a cooking has finished, the cooking process can be saved into the SD Memory Card. (p.36)

Manual Cooking

Cooking in Steps

The microwave power, temperature, cooking time or other can be set for up to three continuous steps.

Use Convection, Grill and Microwave functions to suit your recipe.

ex.: **Manual**, Preheating 280°C → **Step 1** Convection 280°C, Fan speed 100%, Microwave P5, 1 min → **Step 2** Microwave P4, 50 sec → **Step 3** Grill High, Fan speed 30%, 30 sec

● You can use microwave only cooking at Step 2 and Step 3 in Cooking in Steps.

Step 1

- After **Manual** preheating, select **Convection**
- Set the oven temperature, and tap **OK**
- Set **Fan speed**, and tap **OK**
- Select **Microwave**
- Select the microwave power
- Tap **Set time**
- Set the cooking time, and tap **Next**

● "Preheating" (p.28)

■ Maximum power and cooking time for Convection-and-Microwave/Grill-and-Microwave cooking

	Maximum microwave power	Maximum cooking time
Step 1	P6 (800 W)*	2 min.
Step 2	P4 (600 W)	2 min.
Step 3	P2 (300 W)	10 min.

*You can also select P7 (900 W) and P8 (1050 W) when you using Grill Low.

● Maximum cooking time for Convection/Grill/Convection-and-Grill is 30 minutes for each step.

Step 2

- Select **Microwave**
- Select **P4**
- Tap **Set time**
- Set the cooking time, and tap **Next**

Step 3

- Select **Grill**
- Select **High**
- Set **Fan speed**, and tap **OK**
- Tap **Set time**
- Set the cooking time

Press the Start pad.



● The oven starts cooking in order from Step 1 → Step 2 → Step 3.

Notes

- Holding down the pad moves the temperature, fan speed, and time forward faster. This is convenient for setting a longer cooking time, and so on.
- After a cooking has finished, the cooking process can be saved into the SD Memory Card. (p.36)

Memory Cooking

ex.: **Memory**, Preheating 280°C → **Step 1** Convection 280°C, Fan speed 100%, Microwave P6, 1 min → **Step 2** Convection 280°C, Fan speed 60%, 50 sec → **Step 3** Grill High, Fan speed 30%, 30 sec

Memory number: 37

How to Save Memory

There are two methods to save memory cooking – saving a cooking programme after manual cooking and saving a cooking programme in advance.

Up to 100 kinds (default setting: 00–99) of cooking programmes can be saved to the memory.

● The default menu is registered in No. 00–No. 18.

It is useful to cook everyday menus.

You can also overwrite, change or erase previously saved contents.

● This feature cannot be used when memory lock is ON. Please cancel memory lock. (p.27)

Save the programme after manual cooking

1 After cooking is complete, take the food out

- After taking out the food, you can save the cooking programme.

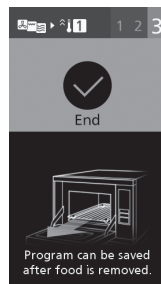

2 Tap **Memory**

- Tap **Cancel** to return to the initial screen.

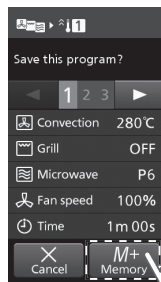

3 Enter the desired memory number

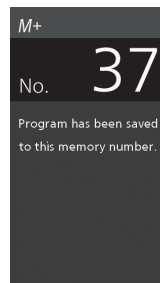

- When the memory number is empty

Save successful
Returns to the initial screen after 3 seconds.

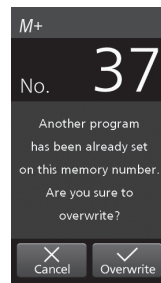

- When the memory number is already used
- Tap **Overwrite** and this screen appears.

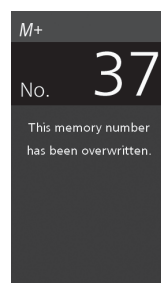

Save successful
Returns to the initial screen after 3 seconds.

Save a programme in advance

1 Select **Tools**

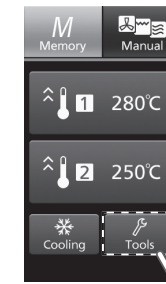

2 Select **Memory cooking**

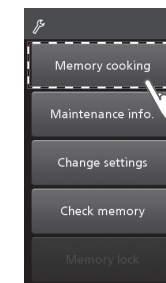

3 Select **Save memory**

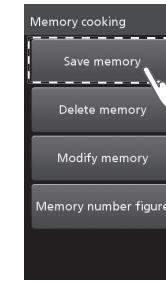

4 Enter the desired memory number and tap **OK**



5 Select preheating

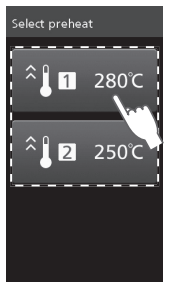

6 Set the cooking time, and tap **Next**

- Tap **Memory** here to display the confirmation screen and complete.

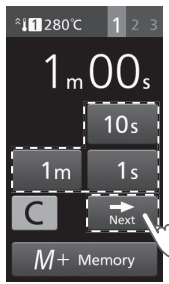

Carry out procedures 1 to 3 of Step 2 of “Cooking in Steps” (p.35)

7 Set the cooking time, and tap **Next**

- Tap **Memory** here to display the confirmation screen and complete.

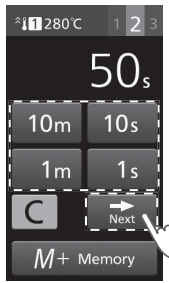

Carry out procedures 1 to 4 of Step 3 of “Cooking in Steps” (p.35)

8 Set the cooking time, and tap **Memory**

- The oven returns to the initial screen after displaying the confirmation screen for 3 seconds.

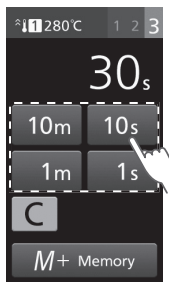

Please note that the preheat temperature saved for the memory cooking will be changed if you change the setting of Preheat temperature. (p.25)

Memory Cooking

How to Delete Memory

● This feature cannot be used when memory lock is ON. Please cancel memory lock. (p.27)

1 Select **Tools**



4 Enter the memory number to delete and tap **OK**



2 Select **Memory cooking**

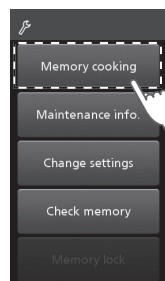

5 Confirm the data and tap **Delete**

- The oven returns to the initial screen after displaying the confirmation screen for 3 seconds.
- Tap **Cancel** to return to the procedure 4.

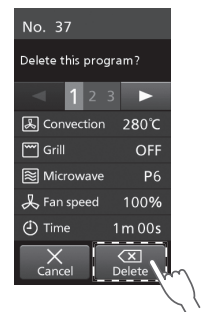

3 Select **Delete memory**

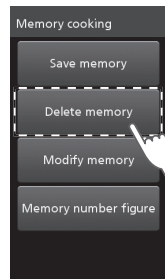

How to Modify Memory

● This feature cannot be used when memory lock is ON. Please cancel memory lock. (p.27)

1 Select **Tools**



5 The previously saved programme is displayed. Modify the item you want to change as per the instructions written in "Save a programme in advance" (p.37)

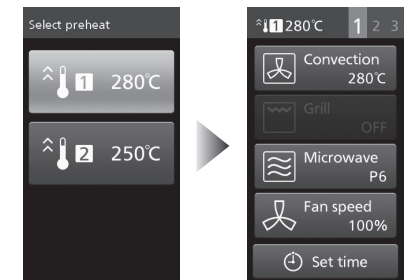

2 Select **Memory cooking**

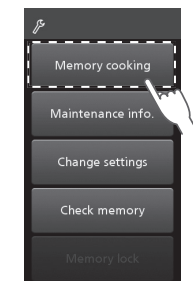

3 Select **Modify memory**

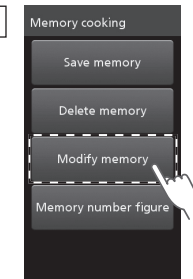

6 Tap **Memory**

- The oven returns to the initial screen after displaying the confirmation screen for 3 seconds.

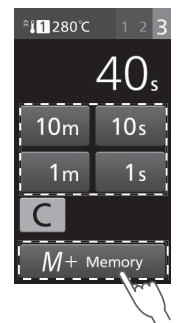

4 Enter the memory number to edit and tap **OK**



Memory Cooking

How to Set the Memory Number Figure

The number of figures for the memory number is set to double as default setting (100 kinds: 00–99). You can also set single-figure (10 kinds: 0–9) or triple figures (1000 kinds: 000–999).

● This feature cannot be used when memory lock is ON. Please cancel memory lock. (p.27)

1 Select **Tools**

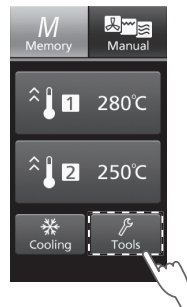

4 Select the desired number of figures and tap **OK**

● The oven returns to the initial screen after displaying the settings for 3 seconds.



2 Select **Memory cooking**

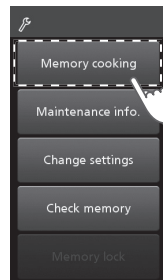

3 Select **Memory number figure**



Cooking with a Saved Cooking Programme

1 Select **1 280°C**



2 Press the **Start** pad

● Pausing or opening and closing the door during preheating will automatically resume preheating after 10 seconds.



3 Preheating has been completed



4 Select a menu after putting the food into the oven and close the door

● **OK** is displayed on the screen when memory lock is ON.
● When memory lock is ON, cooking starts automatically.

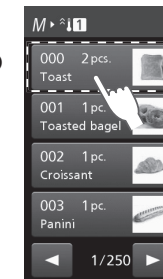

5 The programme is displayed

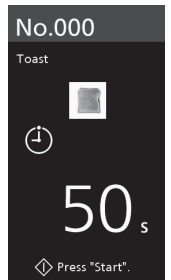

6 Press the **Start** pad (Cooking will start.)

● Tap **Recall** when verifying the settings for the current step.
● When memory lock is OFF, cooking starts after pressing the Start pad.

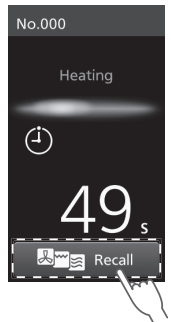
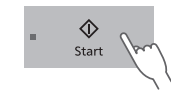

Care of your Oven

It is essential that you follow these points to get the maximum use from your oven. Microwaves are attracted to moisture and grease: therefore a dirty oven does not cook EFFICIENTLY. Failure to maintain the oven in a clean condition could lead to deterioration of the surface that could adversely affect the life of the appliance and possibly result in a hazardous situation.

- This oven requires regular maintenance. (p.45)

⚠ WARNING

- **Pull out the power plug before maintenance.**
If not, this may result in electric shock.
- **Wait for the oven cavity to cool down first before cleaning.**
If not, this may result in burns and injuries.

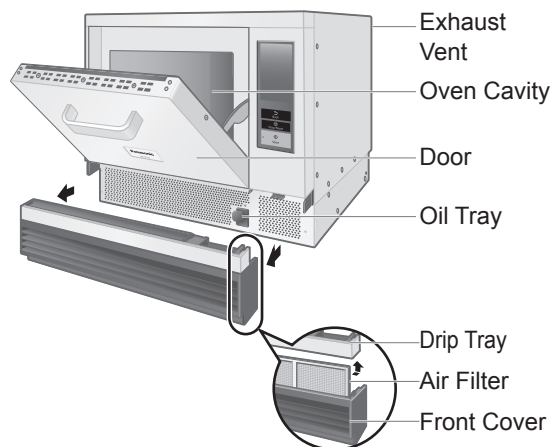

■ Before Cleaning

- Do not clean this oven with a water jet.
- Do not pour detergent and leftover food into the gap and punching holes. This will result in a malfunction.
- If the oven becomes damaged in any way, contact the dealer or a service agent before continuing use.
- Only part that is dishwasher-safe is the Wire Rack. It is prohibited for other accessories, since they may deteriorate due to effect of the detergent (possibility of strong alkaline used), or chipping or cracking due to ceramic parts hitting each other by strong water stream.

Clean these parts Every Day.

■ Oven Cavity • Door Inner Side • Door Seal

Wipe with a damp cloth

Thoroughly wipe away water, oil and leftover food stains frequently to prolong the use of the oven. Failure to remove burnt food remains and dust may cause rust.

If the stains are bad, wipe away with a cloth soaked in a neutral kitchen detergent.

- Do not use alkaline detergent.
- If the stains are even worse, only for the metal part on the inner side of the door, you can use an abrasive cleanser with a hard scrubber.

- Do not scrape the parts other than the metal part inside the door (door seal area etc.) with a hard scrubber, which may cause damage of the door seal and malfunction of the oven. Be sure to use only a soft scrubber.
- Do not splash detergent directly onto the top and rear surfaces of oven cavity. This will result in a malfunction.

OK

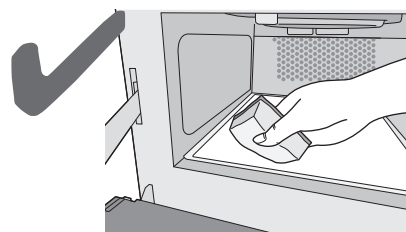

NG



■ Outer Areas

Wipe with a damp cloth

Wipe away oil and food stains immediately.

- Do not use thinner, benzene, abrasive cleanser, bleaching agent, alkaline residential or household synthetic detergent.

If the stains are bad, wipe away with a cloth soaked in a neutral kitchen detergent. Take care not to allow the kitchen detergent to enter the exhaust vent and gaps.

- Outer side of the door • handle area
After wiping with a wet cloth, wipe the areas with soft, dry cloth.

■ Ceramic Tray • Wire Rack • Ceramic Plate • Ribbed Plate • Oven Sheet • Paddle • Base Plate Liner

- Be careful not to rub on the Base Plate Liner when removing accessories.

Wash with a soft scrubber soaked in a neutral kitchen detergent

- Do not use alkaline detergent.

Clean them every time you use it if the stains become a concern.

Only when the dirt is severe, wipe away dirt with rollup plastic wrap or aluminium foil soaked in water and abrasive cleanser.

- Except for Base Plate Liner, Oven Sheet and Paddle.

Disassemble and clean this part Every Day.

■ Drip Tray



Wipe with a damp cloth

- Refer to "How to remove/attach parts". (p.44)

Disassemble and clean these parts Once a Week.

- Refer to "How to remove/attach parts". (p.44)

■ Front Cover

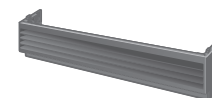

Wipe with a damp cloth

Wipe away oil and food stains immediately. If the stains are bad, wipe away with a cloth soaked in a neutral kitchen detergent.

- Do not use alkaline detergent.

■ Air Filter

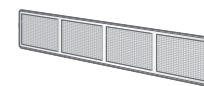

Dry after washing with water

Clean it after every use if the stains are bad. The filter may lose its effect if the stains are left behind. The temperature of the internal parts may also rise, resulting in a malfunction.

■ Oil Tray

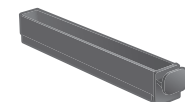

Wipe away oil stains with a soft cloth or paper towel

If the stains are bad, clean the area with a soft scrubber dipped in a neutral kitchen detergent and dry.

- Do not use alkaline detergent.

Care of your Oven

How to remove/attach parts

Front Cover

Removing

Pull out the front cover and remove it.

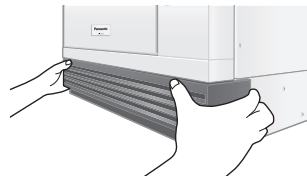

Attaching

Install the main unit (A) into the groove of the drip tray.

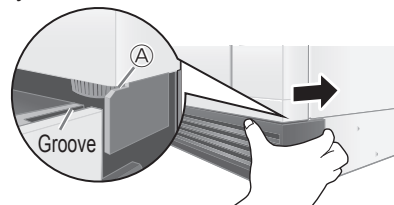

Drip Tray/Air Filter

Removing

Remove the front cover, and then press and shift both ends of the drip tray to detach. Then, pull out the air filter.

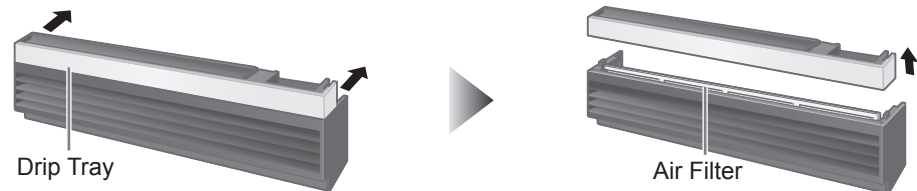

Attaching

Insert the air filter into the groove on the front cover all the way inside, then place the drip tray back in the original position.

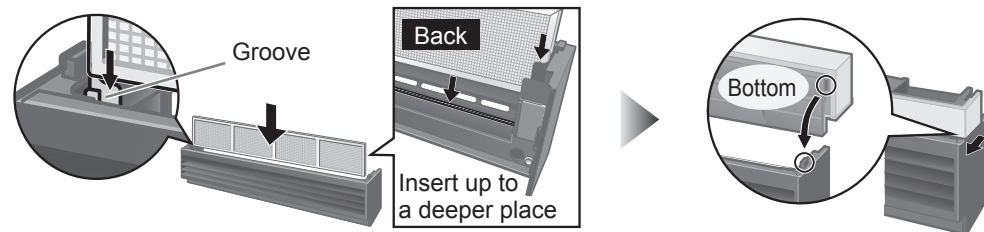

Oil Tray

Removing

Remove the front cover first, and take out the oil tray.

Attaching

Follow the reverse procedure to install the oil tray.

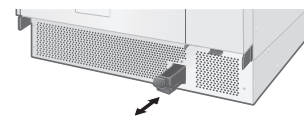

Clean this part once a month.

Exhaust Vent

Clean the rear exhaust vent with a toothbrush and a towel

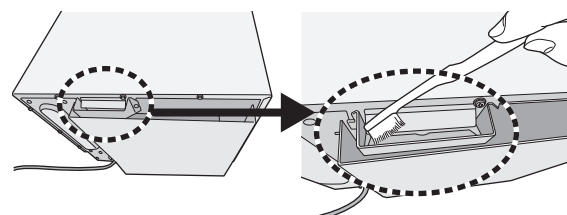

Regular Maintenance

When one of the following is displayed, oven maintenance is required. Continuing to use the oven may cause failure.

Please contact the dealer or a service agent promptly. (p.49)

● Displays until maintenance is done when the power plug is removed and reinserted or when there has been no operation for a while. In addition, the oven will beep 6 times after completing cooking regardless of the settings.

Display	Cause
It is time to perform regular maintenance.	● Displays when the oven has been used for 17,500 hours. Please contact the dealer or a service agent to replace the parts.
It is time to replace the Magnetrons in this oven.	● Displays when the magnetron has been used 120,000 times. Please contact the dealer or a service agent to replace the parts.

● The above time and number of operations is not a guarantee.

Troubleshooting

Troubleshoot following the next procedure when there is a problem.

Symptom	Cause
It does not operate at all	<ul style="list-style-type: none"> ● Is there a power outage? ● Is the breaker in the power distribution board tripped, or the power supply plug unplugged? ● Is the initial screen displayed in the control panel? If the auto power OFF function is in operation, perform the operation after the initial screen is displayed by opening the door.
It does not cook correctly	<ul style="list-style-type: none"> ● Is the cook setting, accessory, or the cook time incorrect? ● Has the oven been sufficiently preheated?
There is a sound	<ul style="list-style-type: none"> ● There will be a sound of cooking starting and the fan will sound.
There is smoke or harsh odour	<ul style="list-style-type: none"> ● A smoke or harsh odour may occur due to burning of the oil for oven cavity protection when the heater is turned on for the first time. Always ventilate and perform a blank baking if it concerns you. (p.9)
There are sparks during cooking	<ul style="list-style-type: none"> ● A metal container can only be used in the oven when not using microwave power. (p.10) ● Is a container containing gold or silver particles used? ● Is any metal (aluminium foil, metallic skewer, etc.) touching the wall of the oven cavity? ● Is the oven cavity rusted? A rust may cause sparks.
The buzzer does not beep	<ul style="list-style-type: none"> ● Is the loudness of the beep set to OFF? The buzzer will not beep when it is set to OFF. (p.24)
There is an odour or smoke	<ul style="list-style-type: none"> ● This is not a malfunction. The catalyst reaction will lower when the cooking temperature is low (approximately 240°C or lower). Also, it may exceed the processing ability when the amount of oil smoke generated during cooking is high.
There is a sour odour	<ul style="list-style-type: none"> ● Depending on the food, a sour odour may occur during cooking, but this is caused by the catalyst reaction and it is not abnormal.
Foods “explode” during heating	<ul style="list-style-type: none"> ● Microwave power level is too high. Reduce power level. ● Skins of foods i.e potatoes, chicken are not pierced. Pierce skins on foods to release pressure build up during heating. NEVER try to boil eggs in shells.
Smoke appears around the door when grilling	<ul style="list-style-type: none"> ● Fat from foods is splashing on to the grill elements and burning. Stop the oven and drain away all excess fat and juices. Watch the food carefully as it grills. Ensure the cavity ceiling and all accessories are cleaned regularly.

Symptom	Cause
The cooking result of a certain memory cooking is different from that of the previous time	<ul style="list-style-type: none"> ● Did the preheat temperature or cooking mode that were set into memory change? (p.25)

Common Queries

Question	Answer
Where can I obtain additional oven accessories?	<ul style="list-style-type: none"> ● Contact the manufacturer or the dealer from whom you purchased the oven.
Can the oven be stacked?	<ul style="list-style-type: none"> ● Only the same oven can be stacked. Be sure to fix with optional parts. For details, refer to “Instruction for Stacking”. (p.20)
Can I dry tea towels and clothes in the oven?	<ul style="list-style-type: none"> ● No. Never put these, or similar items in your Panasonic Oven.
How often should the oven be serviced?	<ul style="list-style-type: none"> ● When the message referring p.48 is displayed, oven maintenance is required. Please contact the dealer or a service agent. (p.49) Continuing to use the oven may cause failure.

When to Call a Service Agent

If a “U” or “F” Appears In The Display

Start all over again after checking the contents when the following display appears. Display disappears when Stop/Reset pad is pressed.

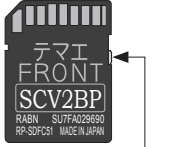
Display	Cause
U16	<p>The SD Memory Card is locked.</p> <ul style="list-style-type: none"> ● Insert the SD Memory Card again after releasing the lock. (p.50)  <p>Lock is released when this part is pushed upwards.</p>
U17	<p>A card other than the specified SD Memory Card is inserted.</p> <ul style="list-style-type: none"> ● Take out the SD Memory Card and check. (p.50) ● If the “U17” appears even after inserting the specified SD Memory Card, the SD Memory Card may be damaged.
U19	<p>The SD Memory Card is not inserted.</p> <ul style="list-style-type: none"> ● Please insert the specified SD Memory Card. (p.50)
U40	<p>The appliance is operated without food in the oven.</p> <ul style="list-style-type: none"> ● Put the food into the oven and heat.
U41	<p>Earthing is incomplete.</p> <ul style="list-style-type: none"> ● Contact the dealer or a service agent. (p.49)
U88	<p>The touch screen is touched for a while.</p> <ul style="list-style-type: none"> ● Has the screen been touched for 25 seconds or more? ● Is there any dirt stuck on the screen?
F code e.g. F30 etc.	<p>If the “F” code does not disappear even after pressing the Stop/Reset pad, pull out the plug and then plug it in again after 5 seconds. The oven is faulty if the “F” code still appears. Contact the dealer or a service agent. (p.49)</p>

If There Is Damage To The Oven

Contact a service agent immediately if you find damage to the supply cord, control panel, cavity, accessories, or the door. It is best not to use the oven again until you have ascertained from the service agent that it is safe to do so. Remember to give the service agent as much information as possible. See “Contacting A Service Agent” below.

If The Oven Is Not Working

If you find the oven is not working, follow these points before contacting a service agent. Check:

1. The oven door is closed.
2. The required function(s) have been set correctly and the Start pad pressed. (pp.28–41)
3. The programme lock has not been activated or deactivated against your requirements.
4. The oven is connected to a 16 amp outlet and the supply is operational. Try another power point, there maybe a problem with the outlet or even a total power failure.
5. The oven is not connected to the electrical supply by means of an adaptor or extension cable.
6. The air vents are not blocked. If they are, unblock them, leave the oven for 15 minutes and then try again.
7. The “Troubleshooting” and “Common Queries” section on pp.46–47.

If the oven is still not operational, contact your service agent with all your details. See “Contacting A Service Agent” below.

Contacting A Service Agent

If your oven should require a service, please contact the below and we will provide details of an appropriate service agent.

UK: +44 344 844 3899

Ireland: +353 012 898 333

(Phone numbers are subject to change without notice.)

When contacting a service agent always remember to state clearly the following information:

1. The address and name, if applicable, of the site where the oven is situated.
2. The telephone number of that site.
3. A contact name at that site.
4. The model number and serial number of the oven; these numbers can be found on the left side of the oven.
5. The problem with the oven, including the Failure Code number.
6. If known, from where and when the oven was purchased.
7. When the site will be open for an engineer to visit.

SD Memory Card

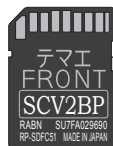

Specified SD Memory Card

- Set in the main unit when shipped from the factory.
- When saving or deleting a cooking process, or when cooking according to a saved programme, be sure to set up and use the specified SD Memory Card. If a card other than the specified SD Memory Card is set up, "U17" appears. (p.48)
- You can also save a cooking programme data onto the specified SD Memory Card using your personal computer. (pp.51–52)

Notes

- Be careful not to impart static electricity to the SD Memory Card while it is not set in the main unit.
- Do not dismantle or modify.
- Do not bend, drop, wet or subject the SD Memory Card to strong impacts.
- Do not touch the metal terminals with your hands or metal.
- Do not peel off the pasted labels. Also, do not paste new labels or stickers.
- Do not expose to direct sunlight or place in other hot locations.
- Do not place in humid or dusty locations.
- Do not place in locations where corrosive and other gases are generated.
- Always close the SD Memory Card cover except when inserting and taking out the card to prevent contamination by water and dirt.
- If the SD Memory Card is lost or becomes faulty, please contact the dealer or a service agent to obtain a replacement. (p.49)

How to insert/remove

- Before you insert / remove an SD Memory Card, always unplug the oven for personal safety. Insert and remove the SD Memory Card with the display unit turned off. Data may be destroyed when it is inserted or removed immediately after the power supply plug is inserted or when the display unit is turned on.

How to remove

① Remove the front cover

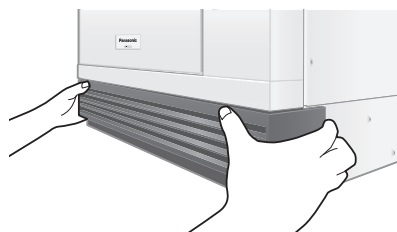

② Turn the screw and open the SD Memory Card cover by tools

SD Memory Card Cover Screw

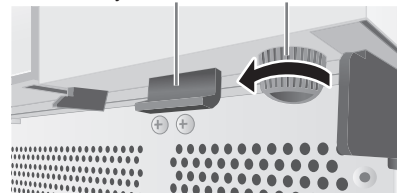

③ Push in the SD Memory Card with your finger

Take out the SD Memory Card when it comes out.

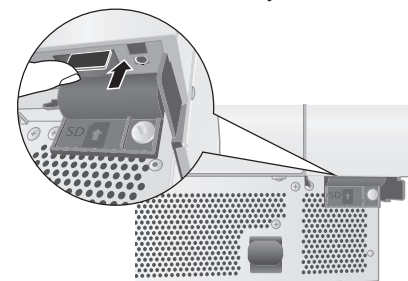

How to insert

① Insert the SD Memory Card all the way inside

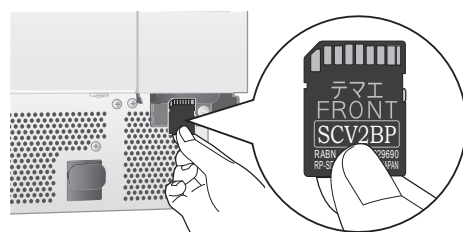

② Close the SD Memory Card cover and tighten the screw by tools

SD Memory Card Cover Screw

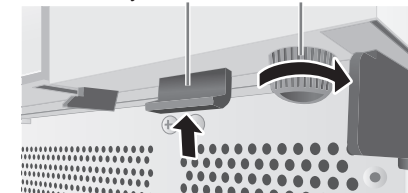

③ Attach the front cover

Install the main unit (A) into the groove of the drip tray.

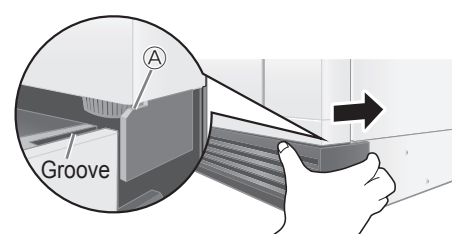

Saving a Cooking Programme on SD Memory Card

You can save a cooking programme data onto the specified SD Memory Card using your personal computer.

Warning

1. It is prohibited to copy the data on an SD Memory Card for business purposes or reproduce it on a website.
2. The "SD" logo is a trademark.
3. Microsoft Windows is a trademark of Microsoft Corporation, U.S.A.
4. The other various designations, brand names, etc. are the registered trademarks of their respective companies.
5. The names of oven you use may be different from those used in this booklet. Windows, messages, etc. used in this booklet may be different from those on your personal computer depending on the environment (OS versions, etc.). Carefully read the instructions for your personal computer to use it.
6. Editing the data directly on the SD Memory Card without copying it to your personal computer may not work properly depending on your environment.
7. Our company assumes no responsibility whatsoever for damage of the data on the SD Memory Card.

Caution

1. It is recommended to use SD Memory Cards with Microsoft Windows 7, Microsoft Excel 2010, or later.
2. Unlock the SD Memory Card otherwise the programme data cannot be stored.

How to Save a Cooking Programme on SD Memory Card using your personal computer

*As of December 2017

Preparing pictures

- ① Turn on your personal computer and activate Windows.
- ② Save desired pictures in an appropriate folder on your personal computer.
 - The recommended size of the image is VGA 640 × 480. When using images other than this size, images may be overlooked or rough.
 - Do not use spaces or symbols for the user names or folder names, etc.

Inserting the specified SD Memory Card

- ③ Inserting the specified SD Memory Card into the SD card reader on your personal computer.
- ④ Double-click the SD Memory Card drive in "My Computer" folder.
- ⑤ Move "meigroup" folder to your personal computer such as Desktop. Avoid moving the folder to a deeper layer of your personal computer.

Rewriting the programme in your personal computer

- ⑥ Double-click "meigroup" folder. Double-click "NE-SCV2BPQ" folder. DO NOT TOUCH other files and folders.
- ⑦ Open "NE_SCV2BPQ_MemoryCookingData.xlsm". If "Enable Content" is displayed, click it. Please input the below data (at least "Preheat Temp" and "Step 1" data is necessary.)
 - Dish Name
 - Picture File
 - pcs.
 - Preheat Temp
 - Step 1 data
- ⑦-1 How to select Picture file
Click "Picture File" cell for a desired Memory Number, then select a picture. Please note that only "jpg" data is acceptable.

SD Memory Card

⑦-2 How to input cooking data

Click the “Function” cell for Step 1, and the drop-down menu will appear. Select a cooking function from the drop-down list.

- GR: Grill
- CV: Convection
- GR+CV: Grill and Convection
- MW+GR: Microwave and Grill
- MW+CV: Microwave and Convection
- MW: Microwave (You cannot use at Step 1.)

Once you select Function, options will appear in yellow. Select options from the drop-down menus. Enter the data for each cooking step.

⑧ When all the programme data has been entered, click “Save Data” in the upper right. (It is not “Overwrite” of Excel file.)

Click “OK” when done.

⑨ Record Checksum 4-digit number for verification.

Overwrite and close “NE_SCV2BPQ_MemoryCookingData.xlsm”.

● If it is not operational, contact the dealer or a service agent. (p.49)

■ Updating the data on the SD Memory Card

⑩ Copy “meigroup” folder of your personal computer such as Desktop to “meigroup” folder on the SD Memory Card to overwrite.

How to verify the data (SD Checksum)

- ① Insert the specified SD Memory Card to the oven.
- ② Follow steps as instructed in p.27 and verify the 4-digit number is same with the one you recorded in step ⑨ above.

How to delete the programme data

- ① Follow steps ① to ⑥ in p.51.
- ② Click “Data Clear”.
- ③ The confirmation screen is displayed. Click “Yes”. The programme data will be all deleted.

Specifications

Power Source	230–240 V, 50 Hz, Single phase	
Required Power	3600 W 15.8 A	
Outlet	16 A	
Output	Microwave	1050 W (IEC 60705)
	Convection	1465 W
	Grill	1915 W
Frequency	2450 MHz	
Convection Temperature Range	180–280 °C	
Preheating Temperature Range	250 °C / 280 °C (Default) Can be changed between 180–280 °C in 10 °C increments	
Net Weight	38.3 kg (including accessories)	
Outer Dimensions (W×D×H)	474 mm×565 mm×412 mm	
Cavity Dimensions (W×D×H)	270 mm×330 mm×110 mm	

Specifications subject to change without notice.

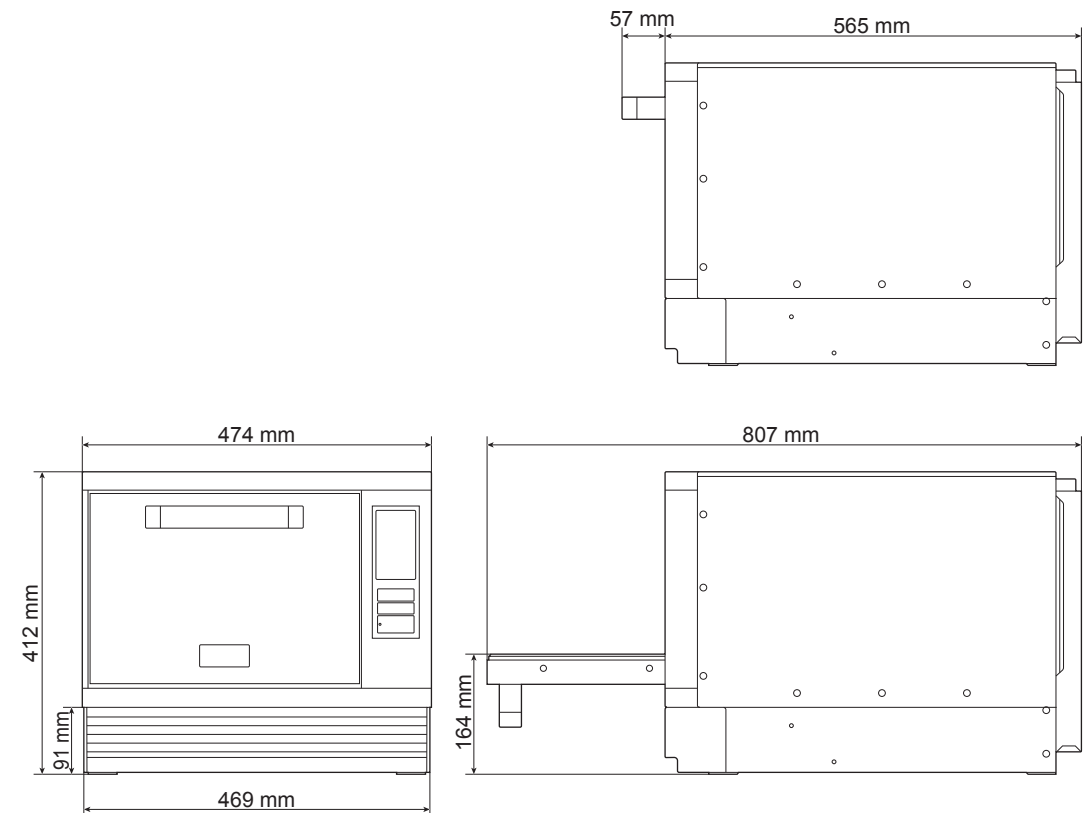

Information on Disposal

Information on Disposal for Users of Waste Electrical & Electronic Equipment (private households)



This symbol on the products and/or accompanying documents means that used electrical and electronic products should not be mixed with general household waste.

For proper treatment, recovery and recycling, please take these products to designated collection points, where they will be accepted on a free of charge basis. Alternatively, in some countries you may be able to return your products to your local retailer upon the purchase of an equivalent new product.

Disposing of this product correctly will help to save valuable resources and prevent any potential negative effects on human health and the environment which could otherwise arise from inappropriate waste handling. Please contact

your local authority for further details of your nearest designated collection point.

Penalties may be applicable for incorrect disposal of this waste, in accordance with national legislation.

For business users in the European Union

If you wish to discard electrical and electronic equipment, please contact your dealer or supplier for further information.

Information on Disposal in other Countries outside the European Union

This symbol is only valid in the European Union.

If you wish to discard this product, please contact your local authorities or dealer and ask for the correct method of disposal.

