

# S952B - S953B - S954B - S955B - S956B - S957B - S958B

PORTA SMARTPHONE/NAVIGATORE DA MANUBRIO GPS/SMARTPHONE-HOLDER FOR HANDLEBAR PORTE-GPS/SMARTPHONE POUR GUIDON  
GPS/SMARTPHONE-HALTER FÜR LENKER PORTA-NAVEGADOR/SMARTPHONE PARA LOS MANILLARES - PORTA SMARTPHONE/GPS PARA GUIDÃO

N°	Descrizione/Description	Caratteristiche/Features	Codice/Code	Quantità/Quantity
1	S952B / S953B / S954B / S955B S956B / S957B / S958B	-	-	1
2	Fascetta - Clamp Pince - Klemme Abrazadera - Braçadeira	-	-	1
3	Coprivite - Screw Cap Cache Vis - Stoppschraube Tapa Tornillo - Tampa do Parafuso	-	-	2
4	Cinghia Di Sicurezza - Fastening Belt Courroie De Fixation - Befestigungsgurt Correa De Sujeción - Cinto De Fixação	-	-	1
5	Riduzione - Reductor Réducteur - Reduktor Reductor - Redutor	-	Z2345	1
6	Adesivo - Sticker - Adhésif - Adhesivo - Aufkleber - Adesivo	-	Z9182	1
7	Spessori - Spacers - Abstandshalter Adhesivo - Aufkleber - Adesivo	ONLY FOR S958B		2

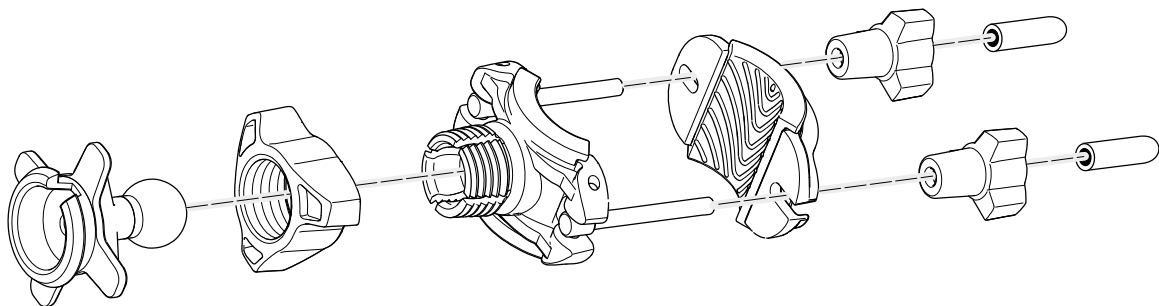
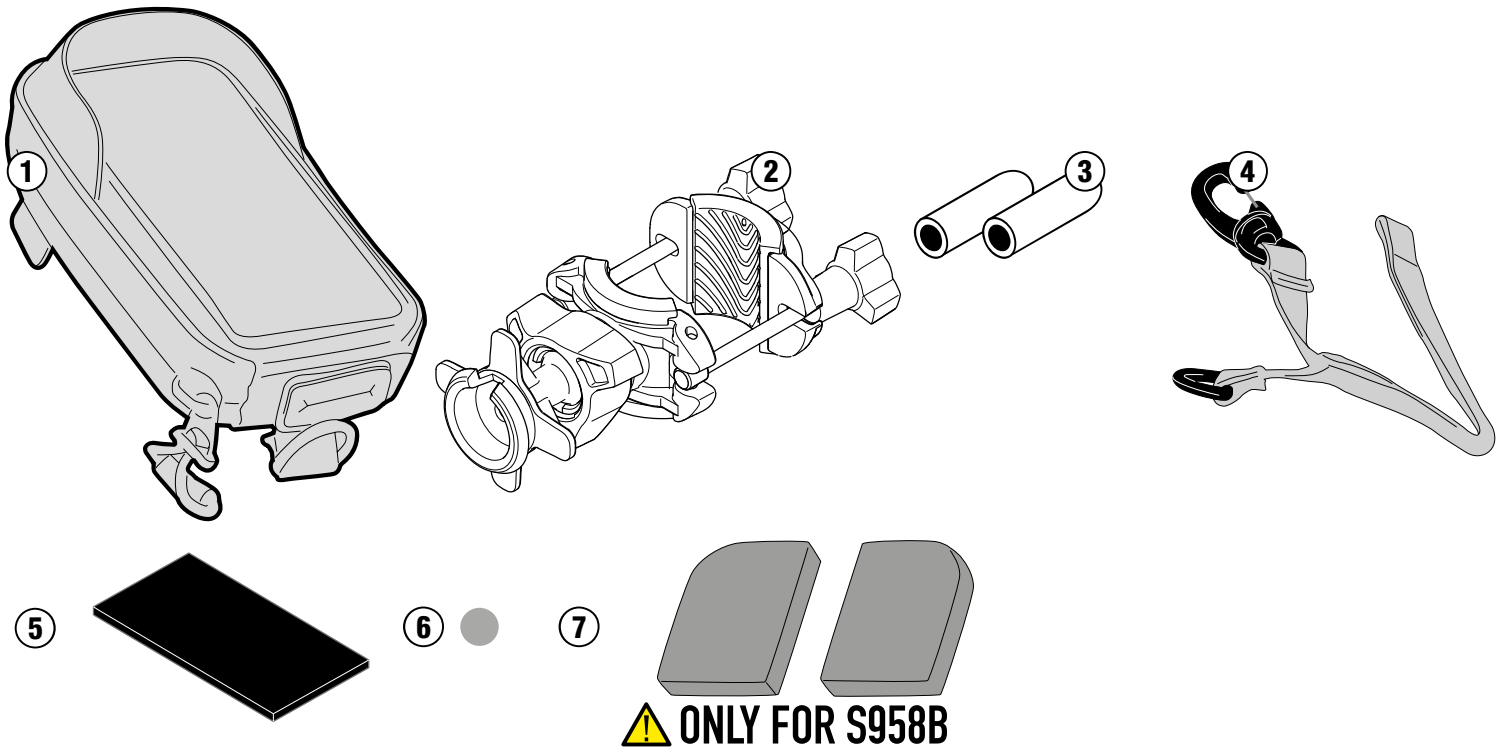

# S952B - S953B - S954B - S955B - S956B - S957B - S958B

PORTA SMARTPHONE/NAVIGATORE DA MANUBRIO GPS/SMARTPHONE-HOLDER FOR HANDLEBAR PORTE-GPS/SMARTPHONE POUR GUIDON  
GPS/SMARTPHONE-HALTER FÜR LENKER PORTA-NAVEGADOR/SMARTPHONE PARA LOS MANILLARES - PORTA SMARTPHONE/GPS PARA GUIDÃO

## S952B

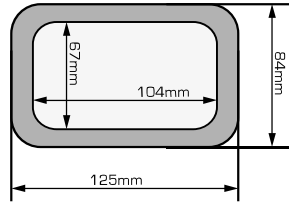
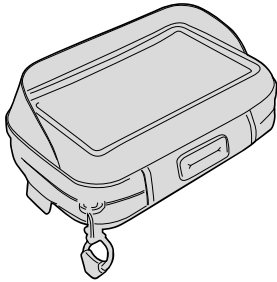

## S955B

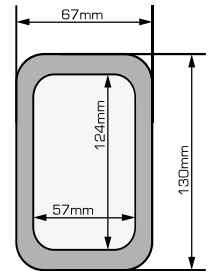
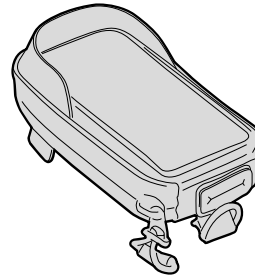

## S953B

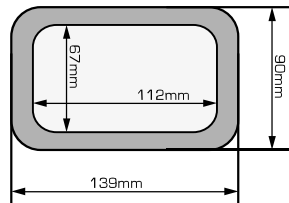
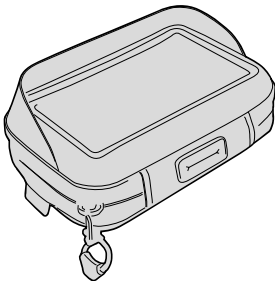

## S956B

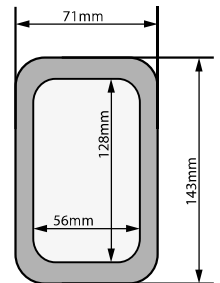
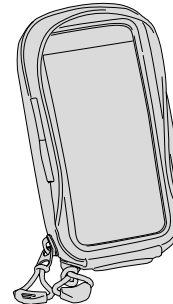

## S954B

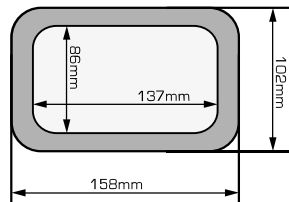
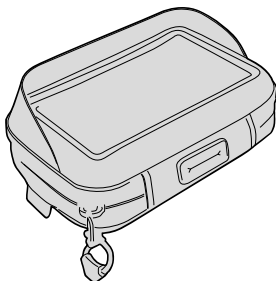

## S957B

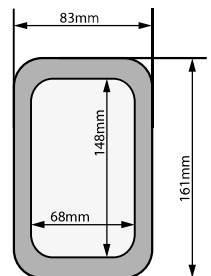
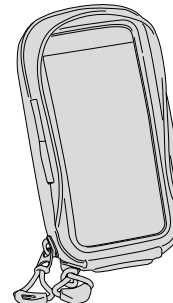

Tutti i marchi e i modelli dei dispositivi sono di proprietà dei rispettivi titolari.

All Trademarks, Names and PDA models are property of the respective Companies.

Toutes les marques, les noms et les modèles déposés sont la propriété respective de leurs compagnies.

Todas las marcas y modelos de los dispositivos son propiedad de sus respectivos titulares.

Alle Marken, Namen und Modellebezeichnungen sind Eigentum der jeweiligen Unternehmen.

Todas las marcas y modelos de dispositivos son propiedad de sus respectivos dueños.

Todas as marcas e modelos de dispositivos são propriedade dos seus respectivos proprietários.

## S958B

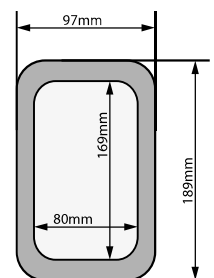
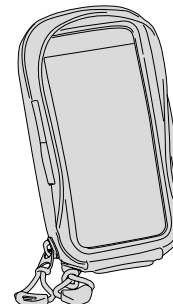

# S952B - S953B - S954B - S955B - S956B - S957B - S958B

PORTA SMARTPHONE/NAVIGATORE DA MANUBRIO GPS/SMARTPHONE-HOLDER FOR HANDLEBAR PORTE-GPS/SMARTPHONE POUR GUIDON  
GPS/SMARTPHONE-HALTER FÜR LENKER PORTA-NAVEGADOR/SMARTPHONE PARA LOS MANILLARES - PORTA SMARTPHONE/GPS PARA GUIDÃO

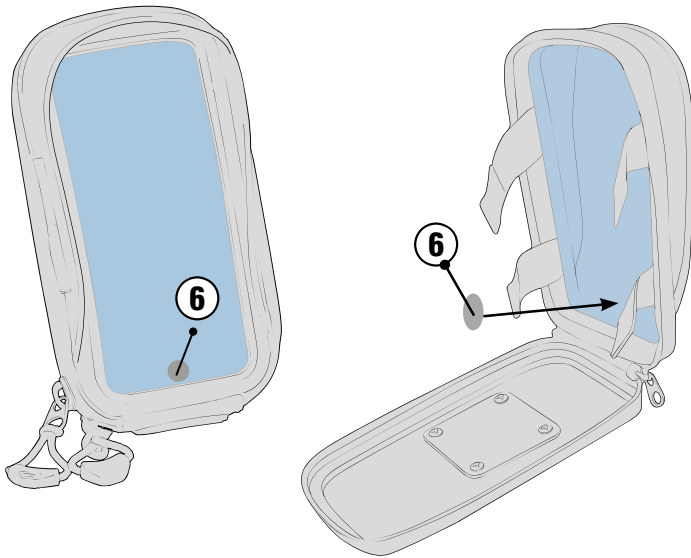

## ONLY FOR: S954B, S956B, S957B, S958B

IT: Fissare l'adesivo Z9182 all'interno della plastica protettiva dello schermo in corrispondenza del pulsante virtuale (per esempio: Iphone 7 / 7 Plus)

EN: Attach part Z9182 inside the plastic screen protector at the precise location of the virtual "home" button on the mobile phone (eg: for Iphone 7 / 7 plus).

DE: Kleben Sie das Z9182 im Inneren des Sichtfensters, an der Position der Home-Taste von Ihrem Handy (zum Beispiel bei iPhone 7 / 7 Plus).

## ONLY FOR S958B

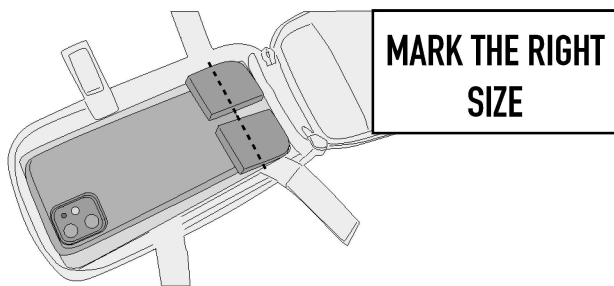

CUT TO THE RIGHT SIZE

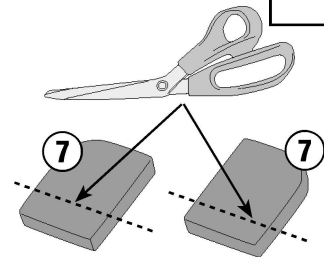

A

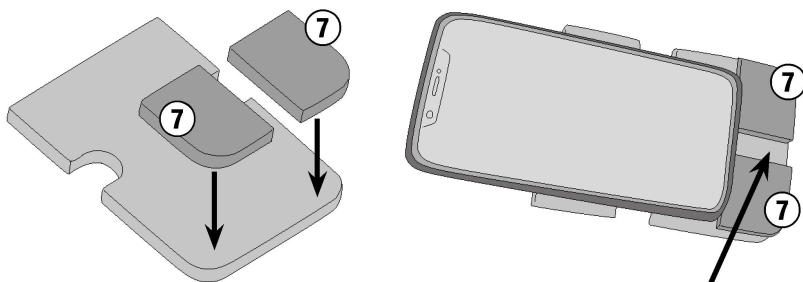

B

IT: Utilizzare i due spessori, ritagliandoli a misura, nel caso in cui si volesse trattenere lo smartphone ancora più stabilmente, mantenendo la possibilità di caricarlo.

EN: To hold the phone more securely while it charges, use both spacers, cutting them to the right size.

DE: Um das Smartphone sicherer zu halten, während es auflädt, verwenden Sie beide Abstandshalter und schneiden Sie sie auf die richtige Größe.

FR: Utilisez les deux épaisseurs, en les découpant à la dimension adéquate, si vous souhaitez retenir le smartphone de manière encore plus stable, tout en conservant la possibilité de le charger .

ES: Si el usuario desea aumentar la estabilidad del smartphone y poder cargarlo en caso de necesidad, utilizar las dos cuñas, recortándolas con la medida adecuada.

PT: Use as duas espessuras, cortando-as no tamanho desejado, para manter o smartphone ainda mais estável, possibilitando também que o mesmo seja carregado.

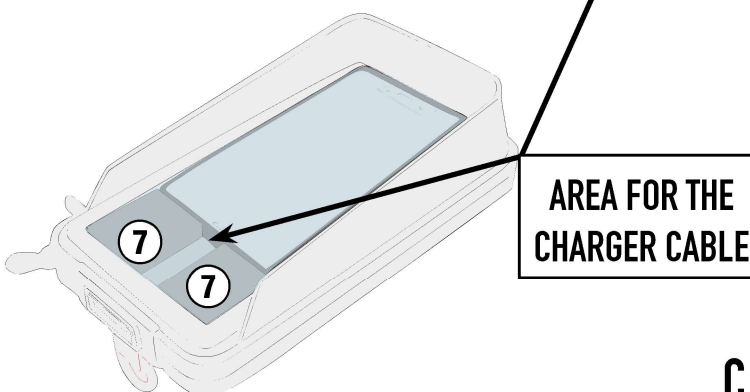

C

# S952B - S953B - S954B - S955B - S956B - S957B - S958B

PORTA SMARTPHONE/NAVIGATORE DA MANUBRIO GPS/SMARTPHONE-HOLDER FOR HANDLEBAR PORTE-GPS/SMARTPHONE POUR GUIDON  
GPS/SMARTPHONE-HALTER FÜR LENKER PORTA-NAVEGADOR/SMARTPHONE PARA LOS MANILLARES - PORTA SMARTPHONE/GPS PARA GUIDÃO

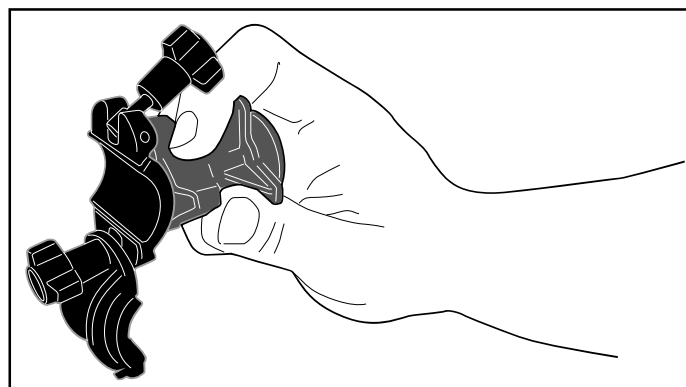
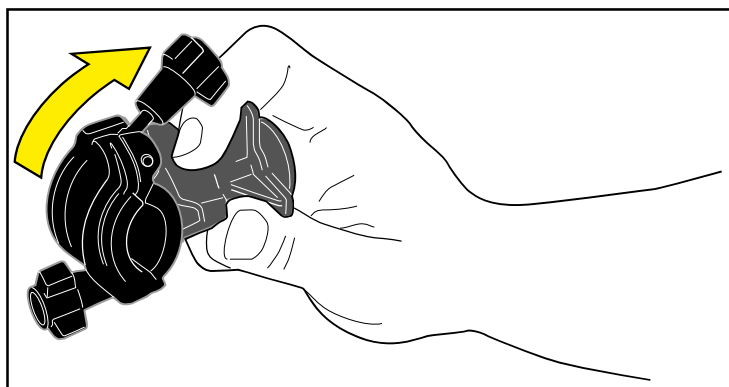
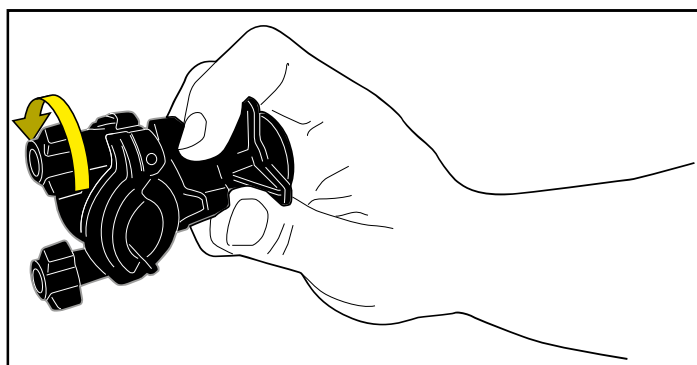
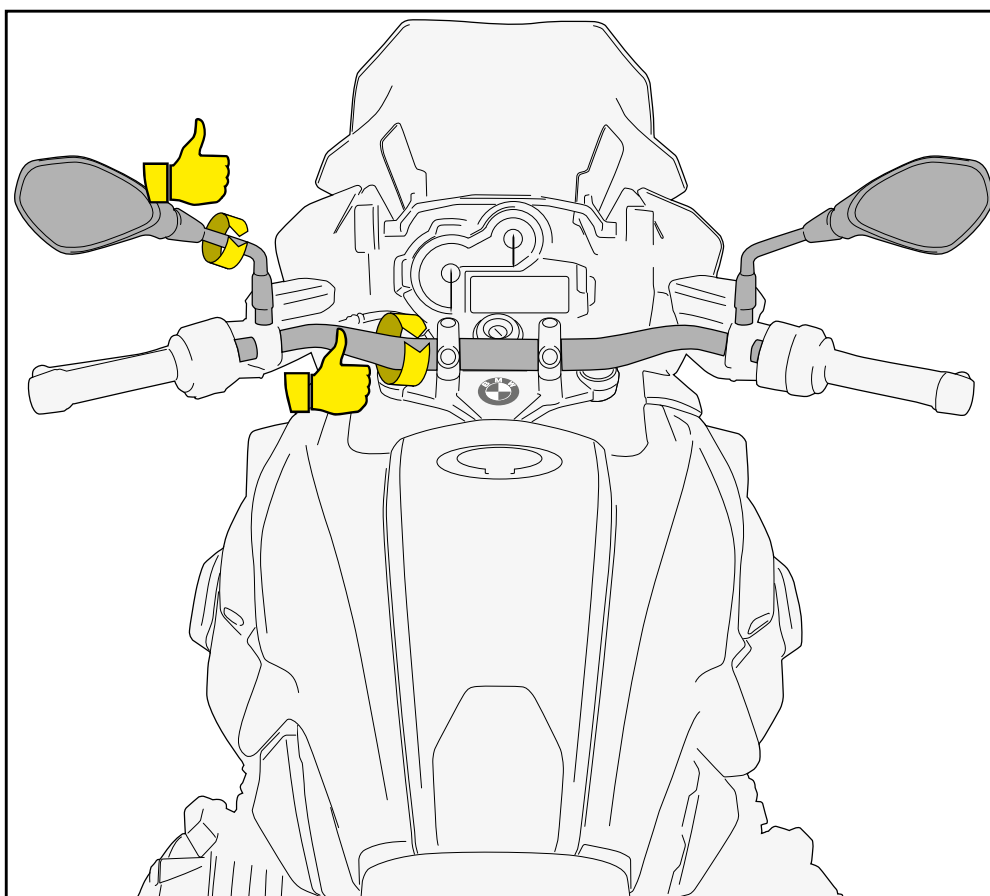

# S952B - S953B - S954B - S955B - S956B - S957B - S958B

PORTA SMARTPHONE/NAVIGATORE DA MANUBRIO GPS/SMARTPHONE-HOLDER FOR HANDLEBAR PORTE-GPS/SMARTPHONE POUR GUIDON  
GPS/SMARTPHONE-HALTER FÜR LENKER PORTA-NAVEGADOR/SMARTPHONE PARA LOS MANILLARES - PORTA SMARTPHONE/GPS PARA GUIÃO

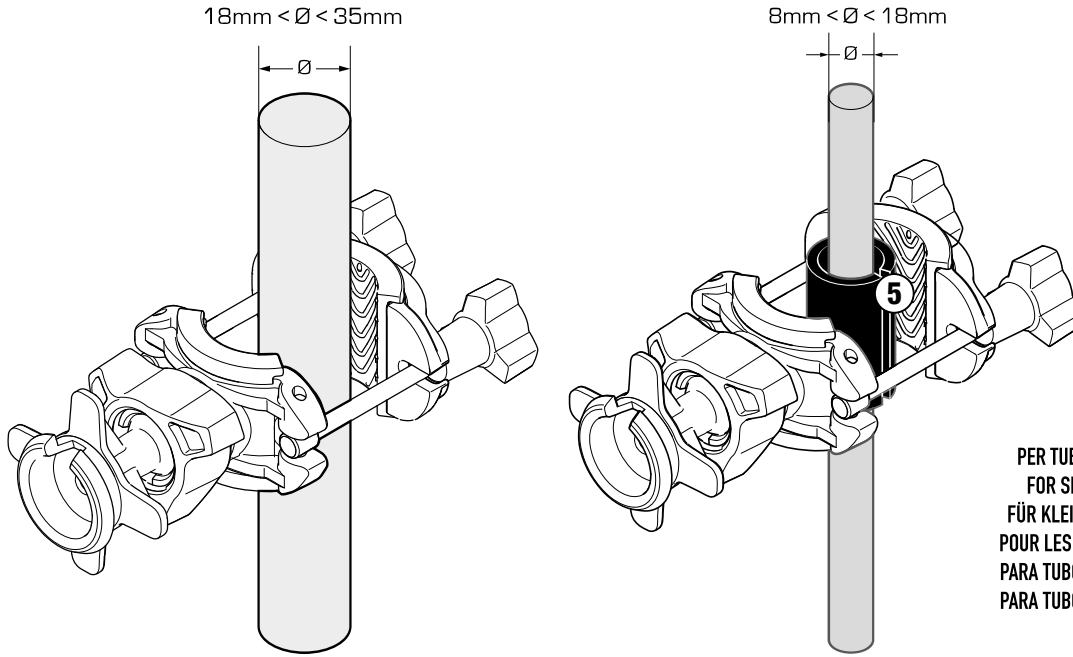

AGGANCI  
COUPLING  
COUPLAGE  
KOPPLUNG  
ENGANCHE  
ACOPLAMENTO

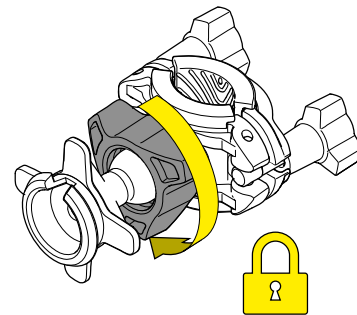
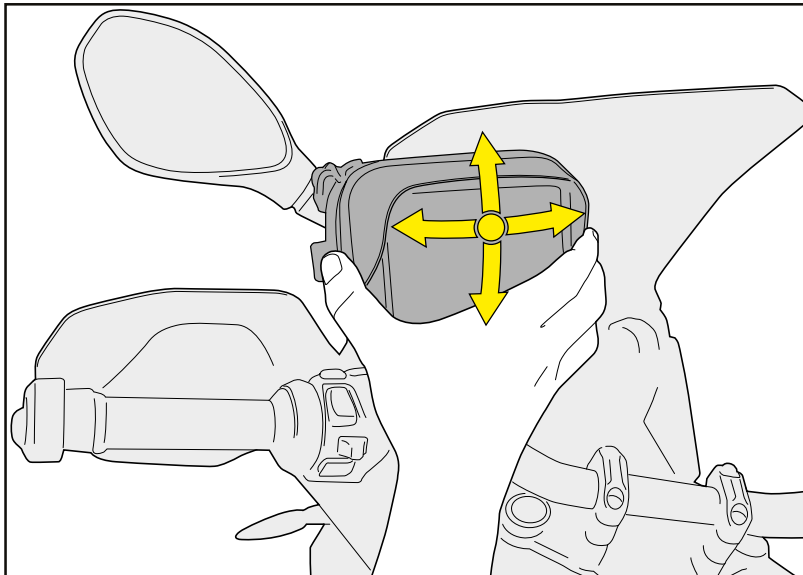
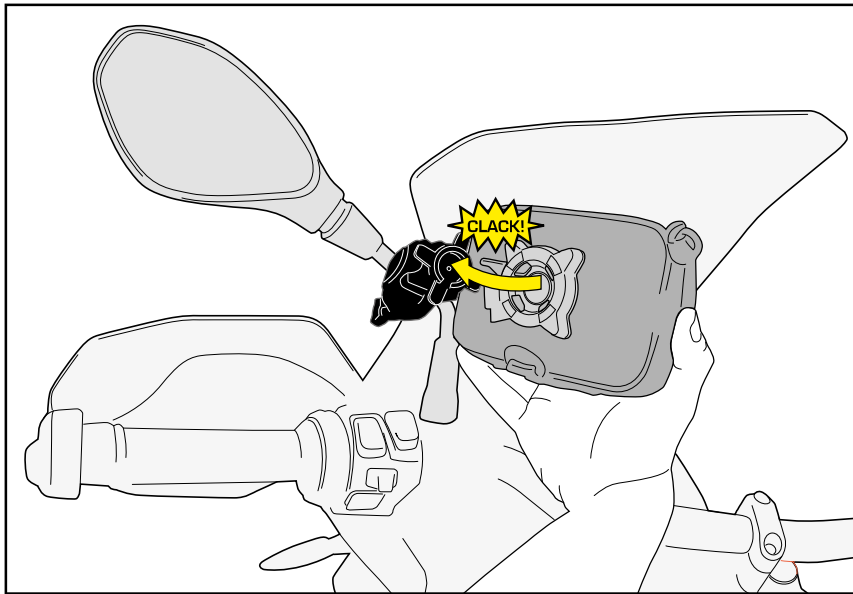

ISTRUZIONI DI MONTAGGIO - MOUNTING INSTRUCTIONS  
INSTRUCTIONS DE MONTAGE - BAUANLEITUNG  
INSTRUCCIONES DE MONTAJE - INSTRUÇÕES DE MONTAGEM

# S952B - S953B - S954B - S955B - S956B - S957B - S958B

PORTA SMARTPHONE/NAVIGATORE DA MANUBRIO GPS/SMARTPHONE-HOLDER FOR HANDLEBAR PORTE-GPS/SMARTPHONE POUR GUIDON  
GPS/SMARTPHONE-HALTER FÜR LENKER PORTA-NAVEGADOR/SMARTPHONE PARA LOS MANILLARES - PORTA SMARTPHONE/GPS PARA GUIDÃO

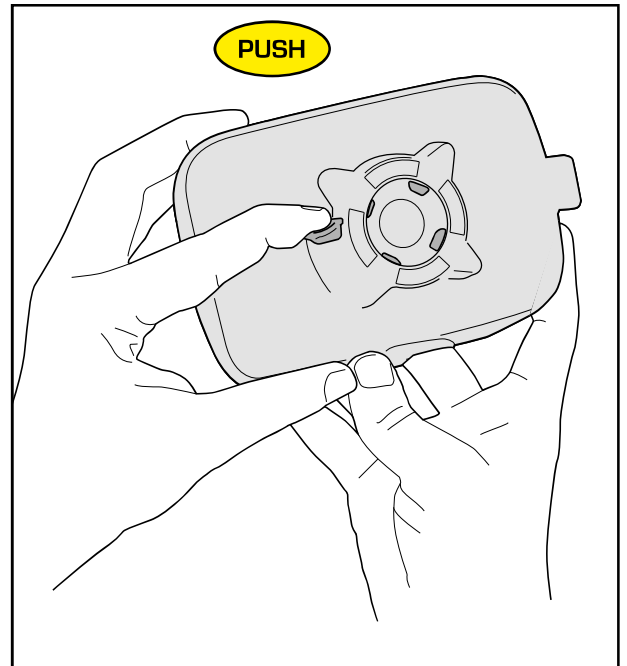
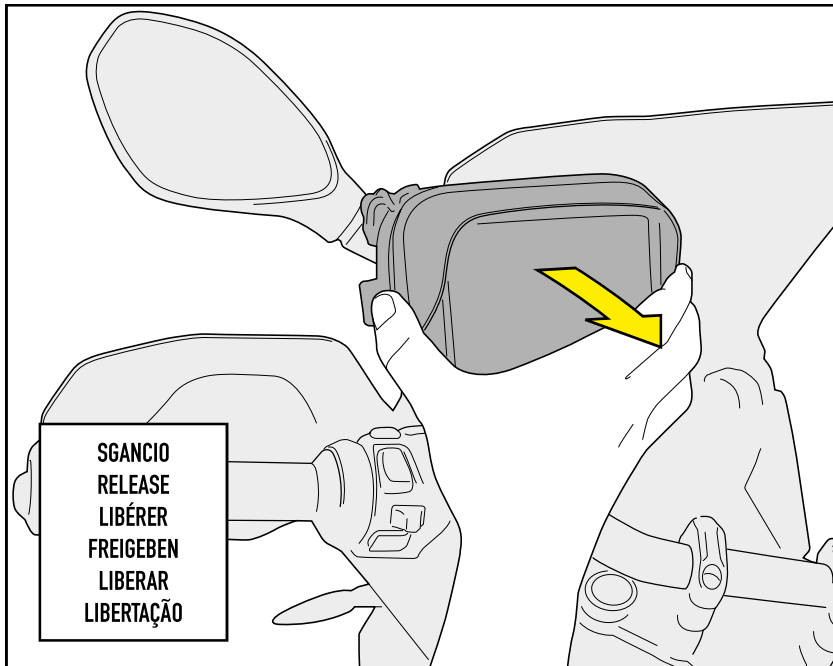

## CINGHIA DI SICUREZZA - FASTENING BELT - COURROIE DE FIXATION - BEFESTIGUNGSGURT - CORREA DE SUJECIÓN - CINTO DE FIXAÇÃO

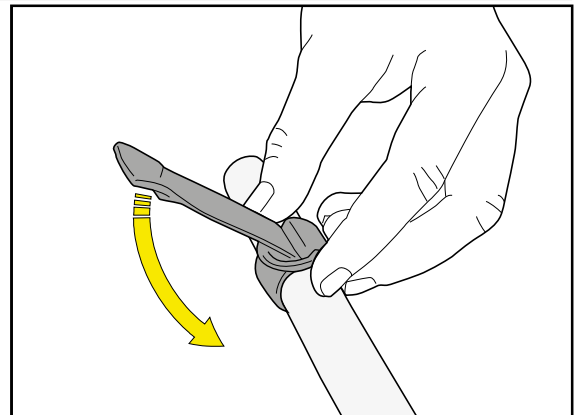
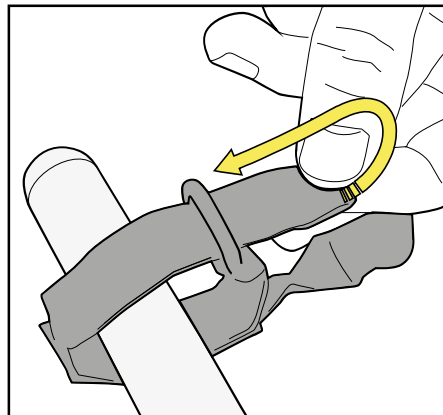
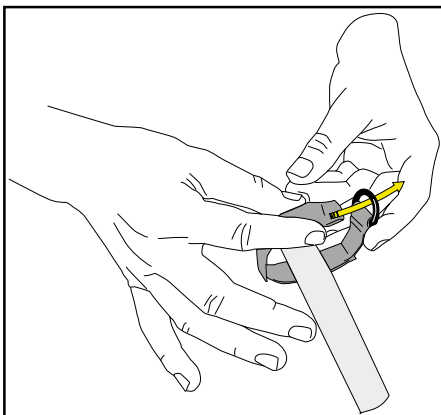
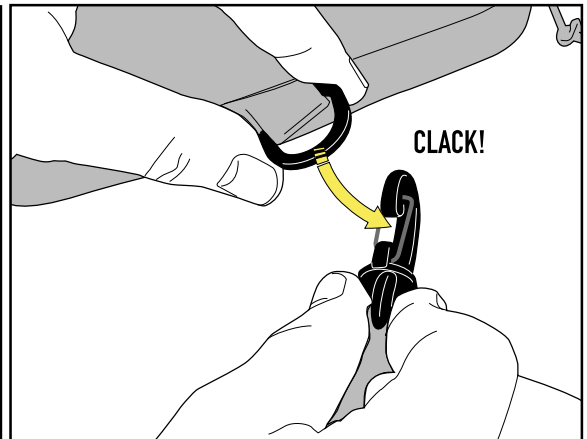
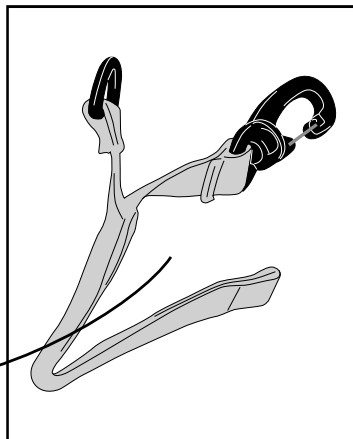
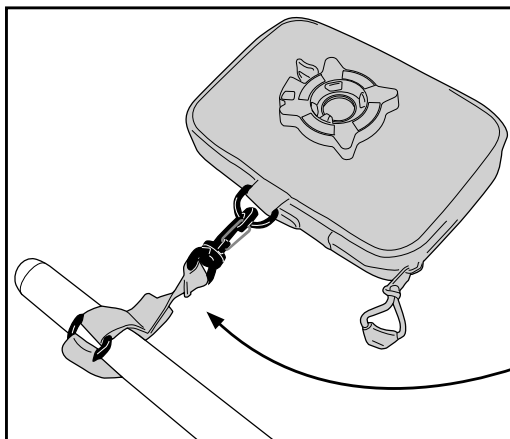

ATTENZIONE: GIVI RACCOMANDA L'USO DELLA CINGHIA DI SICUREZZA E DECLINA OGNI RESPONSABILITÀ IN CASO DI MANCATO UTILIZZO

CAUTION: SECURITY STRAP MUST BE USED, GIVI CANNOT BE HELD RESPONSIBLE IF NOT USED

VORSICHT! VERWENDEN SIE DIE SICHERHEITSGURTE! WIR LEHNEJEN JEDE HAFTUNG AB, DIE DURCH UNSACHGEMÄSSE HANDHABUNG DER TASCHEN VERURSACHT WURDE.