

S150

N°	Descrizione	Caratteristiche	Codice	Quantità
1	Portapacchi - Luggage Rack Porte-Bagages - Gepäckgitter Portaequipaje	-	S150	1
2	Vite - Screw Vis - Schraube Tornillo	TBEI M6x16	616TBEI	4
3	Vite - Screw Vis - Schraube Tornillo	-	M6x16	4
4	Vite - Screw Vis - Schraube Tornillo	-	M6x20	4
5	Rondella In Gomma - Rubber Washer Rondelle En Caoutchouc - Gummi Scheibe Arandela De Goma	-	Z267	8
6	Sede vite semisferica - Location for semi-spherical screw - Emplacement pour vis semi-sphérique - Sede tornillo semisférico - Platz für halbkugelförmige Schraube - Lugar para parafuso semi-esférico	-	Z9523	4
7	Tappo Ovale - Oval cap - Bouchon ovale - Tapón ovalado - Ovale Stopfen - Tampa oval	-	Z9520	4
8	Tappo tondo - Round cap - Bouchon rond - Tapón redondo - Runde Abdeckkappen - Tampa redonda	-	Z9521	2
9	Piedini - Feet - Pattes - Füßen - Pies	-	Z9522	4
10	Inserto Esagonale Filettato - Hexagonal Threaded Insert - Insert hexagonal fileté - Inserto hexagonal roscado - Sechskant Gewindeeinsatz - Inserção hexagonal com rosca	-	V908	4

MAX LOAD 3KG

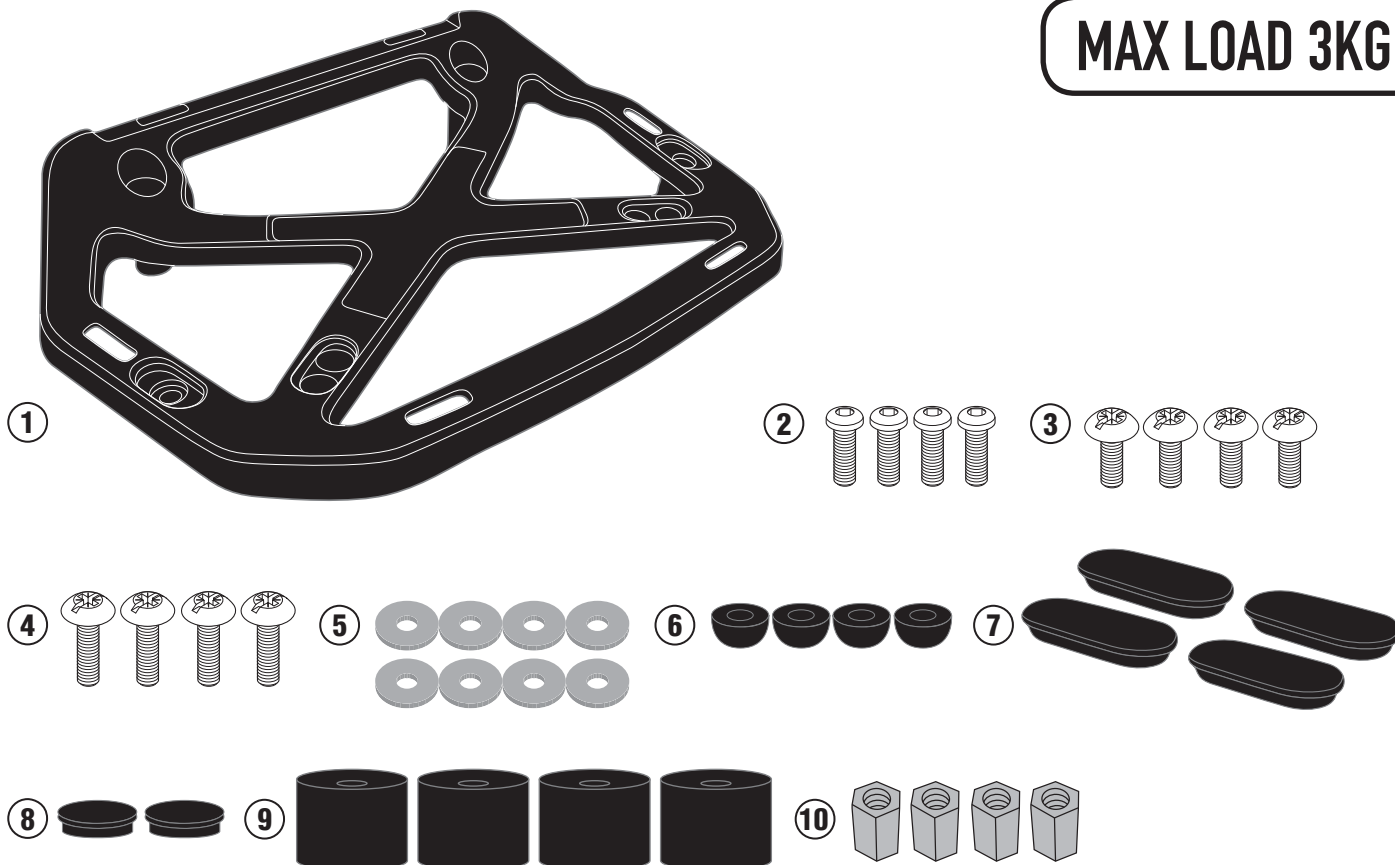

Per montaggio su bauletti per i quali non è presente la dima di foratura:

Posizionare il portapacchino sul coperchio trovando la posizione più idonea (considerando il fatto che normalmente il bauletto in moto rimane leggermente inclinato).

Verificare quali sono i 4 fori degli 8 presenti sul portapacchino, che più si prestano ad essere utilizzati per il fissaggio sul proprio bauletto.

Marcare i due punti di appoggio posteriori con una matita

Segnare il centro del cerchio e forare con una punta di piccolo diametro. Allargare il foro fino ad un diametro di 6,5mm

Montare il portapacchino, segnare i due piedini rimanenti procedendo poi come al punto precedente.

Verificare in base allo spessore del coperchio del bauletto se servono le viti N°3 lunghe 16mm o le viti N°4 lunghe 20mm.

Instructions for mounting on a top case when a drilling template is not available:

Position the rack on the lid, locating the best position (considering that usually a case tilts whilst a motorcycle is in motion).

Establish which 4 of the 8 holes on the rack are best suited to be used to fix the rack to the case.

Mark the two rear fixing points with a pencil.

Mark the centre of the hole and drill it using a small drill bit. Widen the hole to a diameter of 6.5mm.

Mount the rack, mark the two remaining feet and then repeat the previous step.

In respect of the thickness of the case lid, it is necessary to establish whether No 3 screws (16mm long) or No 4 screws (20mm long) are required.

Montageanleitung für Topcases ohne vorhandene Bohrschablone:

Positionieren Sie den Träger auf dem Deckel in möglichst bester Position. Bitte bedenken Sie dabei, daß das am Fahrzeug montierte Topcase leicht nach vorne geneigt ist.

Prüfen Sie, welche 4 der insgesamt 8 Befestigungspunkte des Trägers am besten für die Montage geeignet sind.

Markieren Sie die beiden hinteren Befestigungspunkte mit einem geeigneten Stift.

Ermitteln Sie die Mitte der Markierungen und bohren dort mit einem dünnen Bohrer durch den Deckel, erweitern Sie die Bohrungen bis zum endgültigen Durchmesser von 6,5 mm.

Befestigen Sie den Träger, und markieren Sie die beiden vorderen Montagepunkte; wiederholen Sie dort die Bohrungen wie bereits beschrieben.

Verwenden Sie abhängig von der Materialstärke des Deckels entweder die Schrauben Nr. 3 (16mm lang) oder Nr. 4 (20mm lang).

Instructions pour installer sur un top case ou les marques de perçage ne sont pas présentes:

Positionner la petite grille sur le couvercle en trouvant la meilleure position (considérant que le top case bouge un peu en roulant)

Vérifier lesquels des 4 trous disponibles sur les 8 de la grille sont les mieux placés pour la fixation

Marquer les 2 trous arrière avec un crayon

Marquer les 2 centres de ces trous et faire un avant-trou. Percer au diamètre de 6,5mm

Monter la grille, marquez les 2 trous avant et répéter la procédure

Vérifier en fonction de l'épaisseur du top case si vous devez utiliser les vis N°3 (16mm) ou les N°4 (20mm).

Instrução para montagem dos racks superior quando o molde de furação não estiver presente:

Posicione o rack pequeno na tampa encontrando a melhor posição (considerando que normalmente o baú se inclina ligeiramente durante a viagem).

Verifique se 4 ou 8 furos no rack são mais adequados para ser usado para fixar o rack na tampa.

Marque os dois pontos de fixação parte traseira com um lápis.

Marque o centro do furo e fure usando uma pequena broca. Alargar o furo para um diâmetro de 6,5 milímetros.

Monte o rack, marcar os dois os suportes remanescentes e em seguida, repita o procedimento anterior.

Verifique de acordo com a espessura da tampa do baú de se precisar de N° 3 parafusos (16mm de comprimento) ou N° 4 (20 mm de comprimento).

Para montaje en baúles donde no está presente la plantilla de perforación:

Posicionar el porta paquetes en la tapa encontrando la posición más idónea (considerando el hecho que normalmente el baúl en la moto permanece ligeramente inclinado).

Verificar cuales son los 4 agujeros de los 8 presentes en el portapaquetes, que más se adaptan a ser utilizados para la fijación sobre el propio baúl.

Marcar los dos puntos de apoyo posterior con un lápiz.

Señalar el centro del círculo y perforar con una punta de poco diámetro. Abrir el agujero hasta un diámetro de 6,5mm

Instalar el portapaquetes, señalar los dos puntos de apoyo restantes procediendo como en el punto anterior.

Verificar en base al espesor de la tapa del baúl si sirve la tornillería N°3 longitud 16mm o la tornillería N°4 longitud 20mm

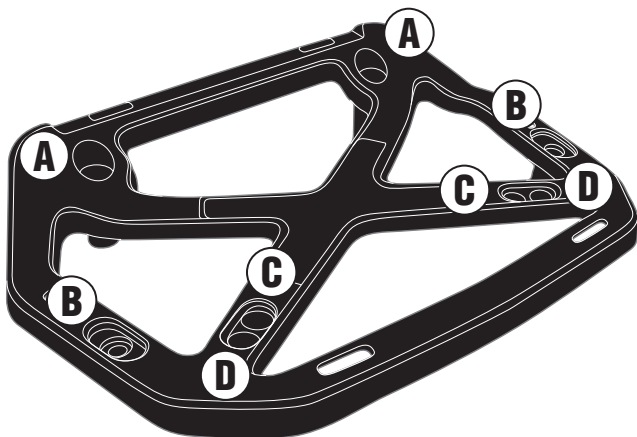

POSSIBLE CONFIGURATION

Ⓐ + Ⓑ

Ⓐ + Ⓒ

Ⓐ + Ⓓ

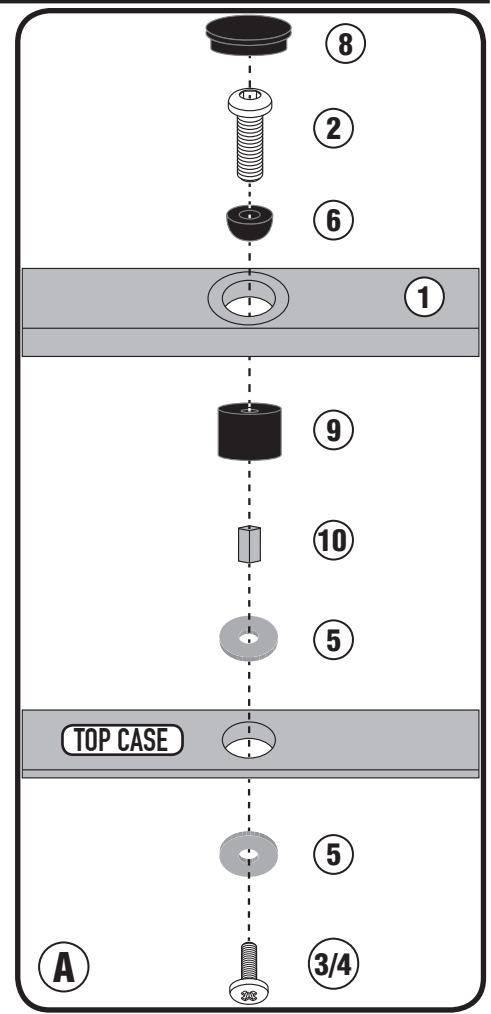
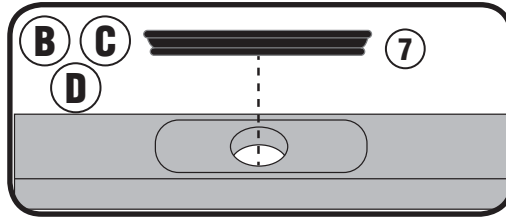
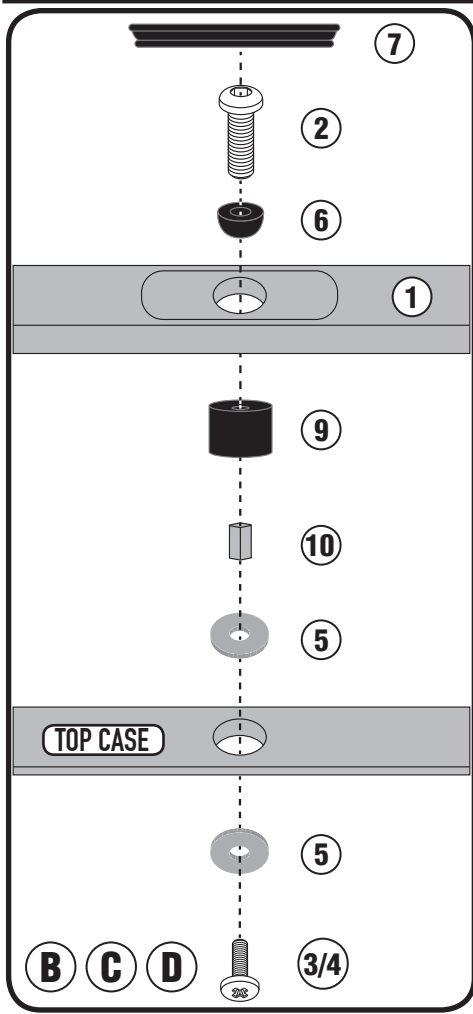

TREKKER 52 / 46 / 33 LT

Per montaggio su bauletti TREKKER 52 - 46 - 33 It:

- Posizionare il portapacchino centralmente sul coperchio, facendo corrispondere i 2 piedini posteriori al fascione trasversale (Fig. A);
- Marcare solamente i punti di appoggio posteriori con una matita (Fig. B);
- Segnare il centro del cerchio e forare con una punta di piccolo diametro. Allargare il foro fino ad un diametro di 6.5mm;
- Montare il portapacchino, segnare i 2 piedini rimanenti procedendo, poi, come al punto precedente.

To mount on top case TREKKER 52 - 46 - 33 It:

- Place the small carrier centrally on the lid, by matching the 2 rear feet to the transverse band (Fig. A);
- Mark only the rear support points with a pencil (Fig. B);
- Mark the center of the circle and drill with a small diameter tip. Enlarge the hole up to a diameter of 6.5mm;
- Mount the small carrier, mark the 2 front feet and proceed as per the previous paragraph

A installer sur le top case TREKKER 52 - 46 - 33 It:

- Positionner le porte-bagages au centre du couvercle en faisant correspondre les deux petites pattes arrière contre la bande transversale (photo A) ;
- Marquer seulement les points d'appui arrière avec un crayon (photo B), ce qui donne un cercle ;
- Marquer le centre du cercle et percer à l'aide d'une mèche de petit diamètre. Agrandir le trou jusqu'à obtenir le diamètre de 6,5mm ;
- Monter le porte-bagages, marquer les 2 petites pattes restantes en procédant comme pour les points d'appui arrière.

Zur Montage auf Topcases TREKKER 52 - 46 - 33 It:

- Positionieren Sie den Gepäckgitter in der Mitte des Kofferdeckels, so dass die 2 hinteren Füßen mit dem queren Kofferumrandung übereinstimmen (Bild A);
- Markieren Sie nur die hinteren Kontaktpunkte mit einem Bleistift (Bild B);
- Zeigen Sie die Mitte des Ringes und bohren Sie den mit einem kleinen Bohrer. Vergrößern Sie die Bohrung bis einen Durchmesser von 6,5 mm;
- Montieren Sie den Gepäckgitter, markieren Sie die 2 restlichen Füße, und folgen Sie die selben Anweisungen von vorherigen Punkt.

Para montaje en los baules TREKKER 52 - 46 - 33 It:

- Posicionar el porta paquetes centrado en la tapa, haciendo corresponder los 2 pies posteriores a la banda transversal (imagen A);
- Marcar solamente los puntos de apoyo posteriores con un lápiz (imagen B)
- Marcar el centro del círculo y agujerear con una punta de diámetro pequeño. Alargar el agujero hasta que tenga el diámetro de 6,5mm;
- Montar el portaequipaje, marcar los 2 pies de manera que queden en el punto antecedente.

TRK52 TREKKER

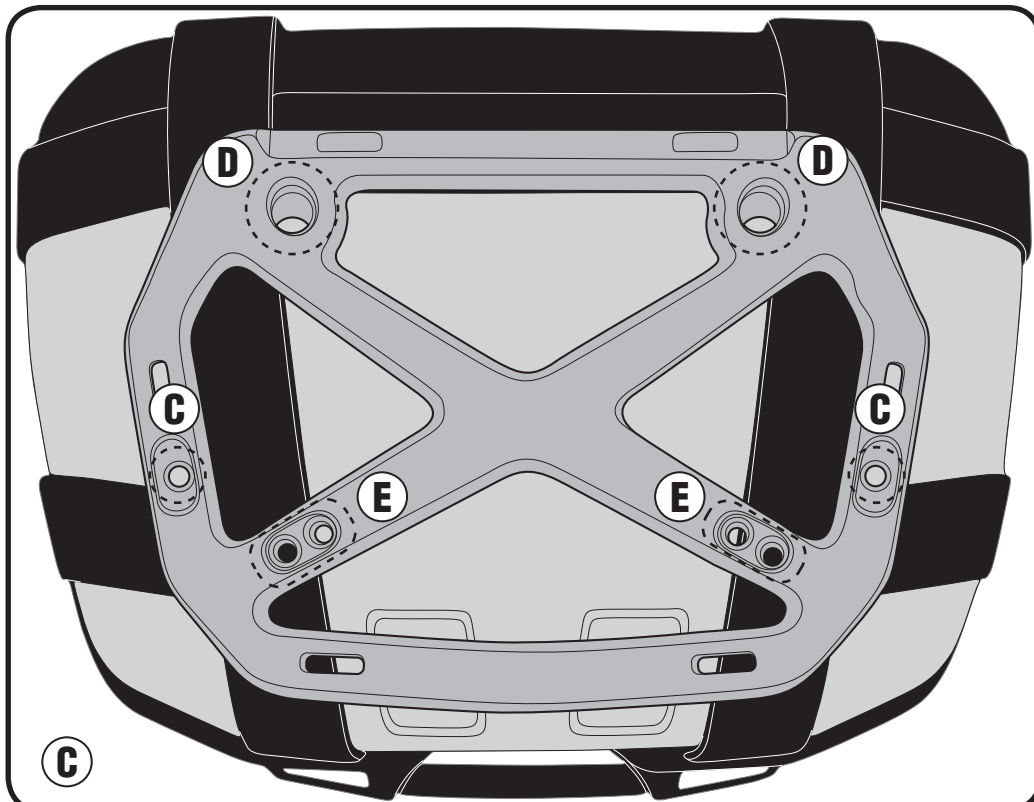
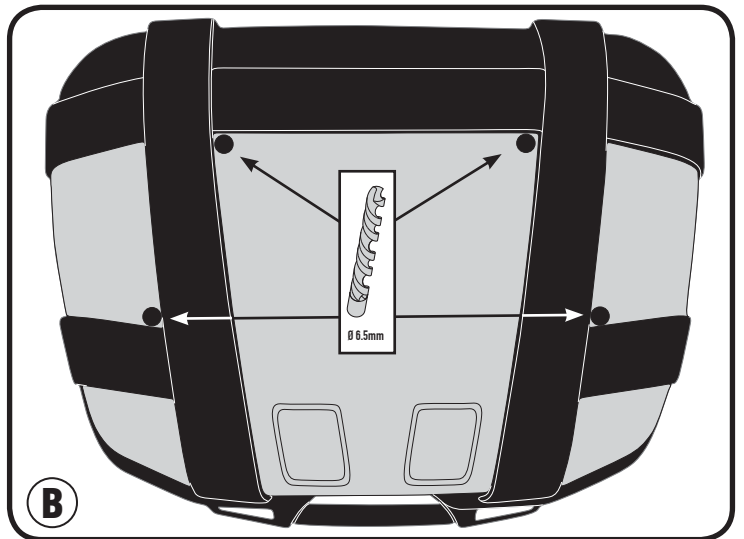
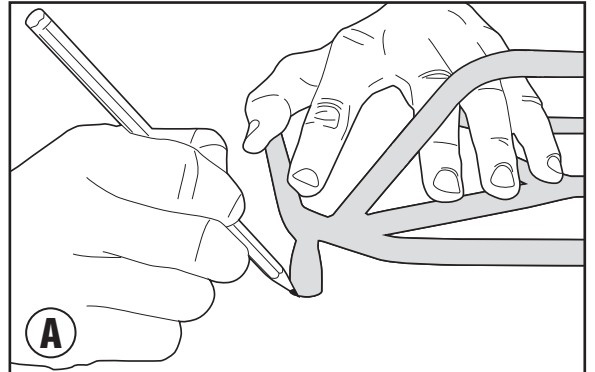
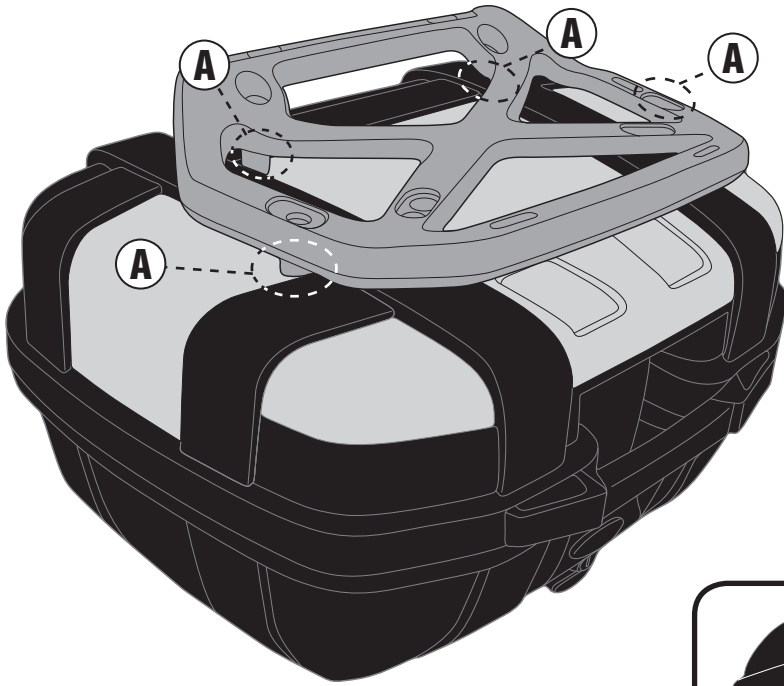

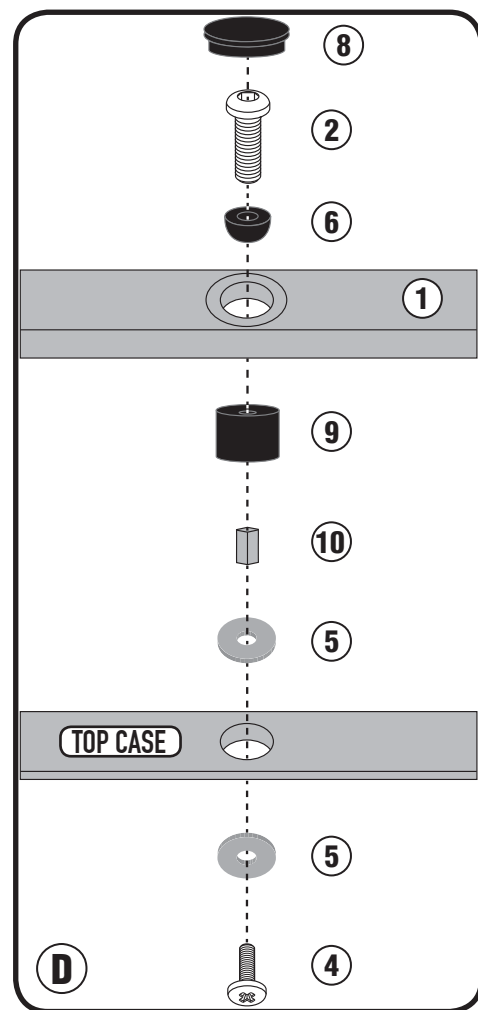
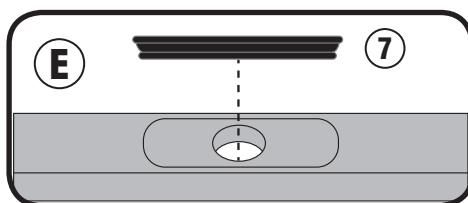
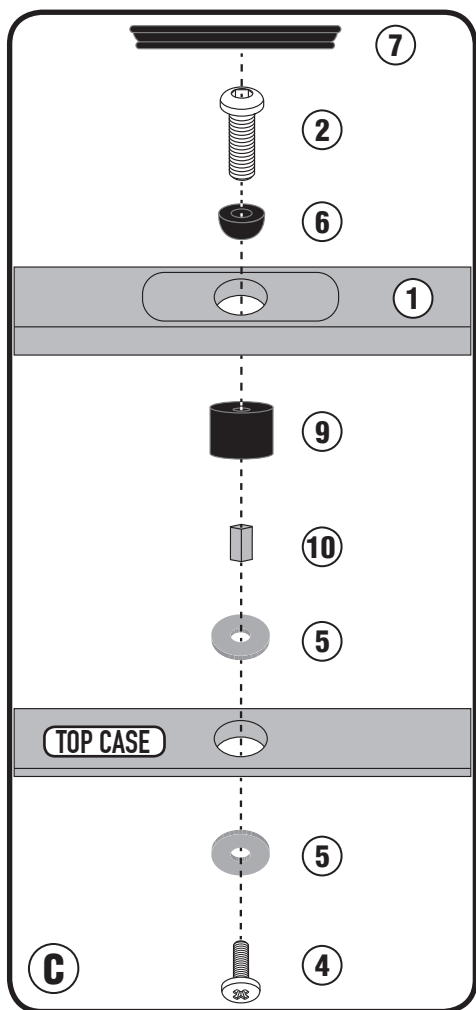

TRK33/46N TREKKER

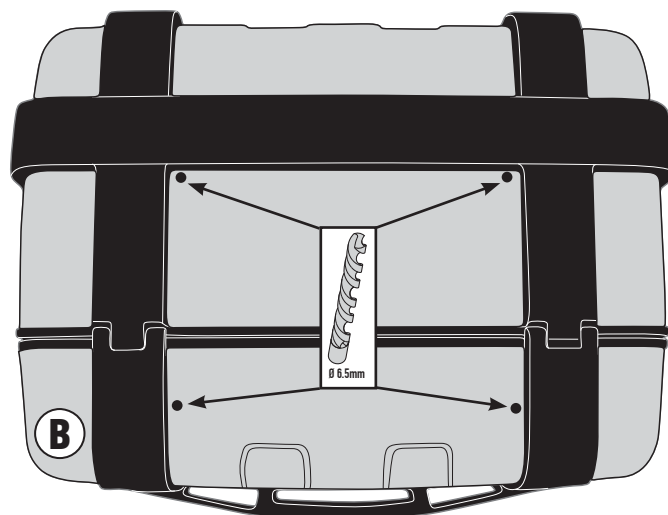
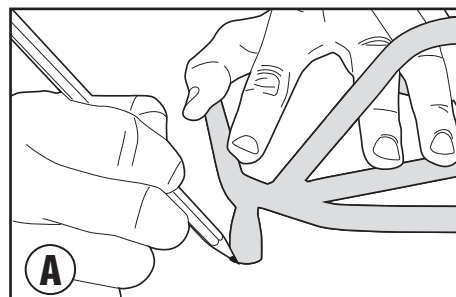
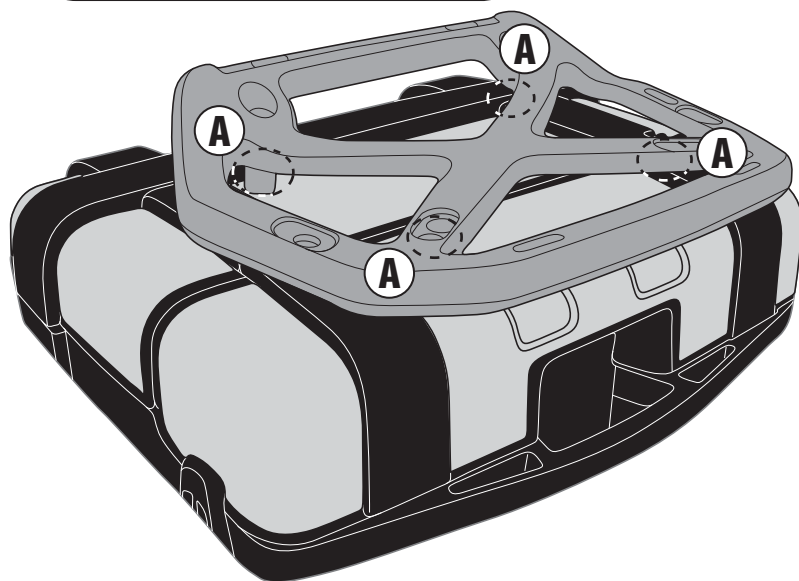

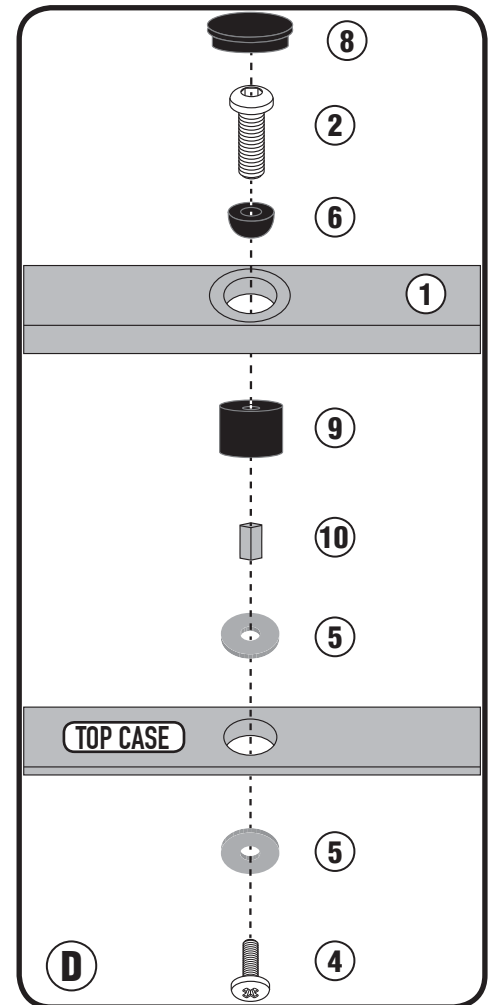
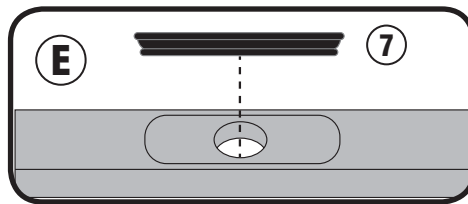
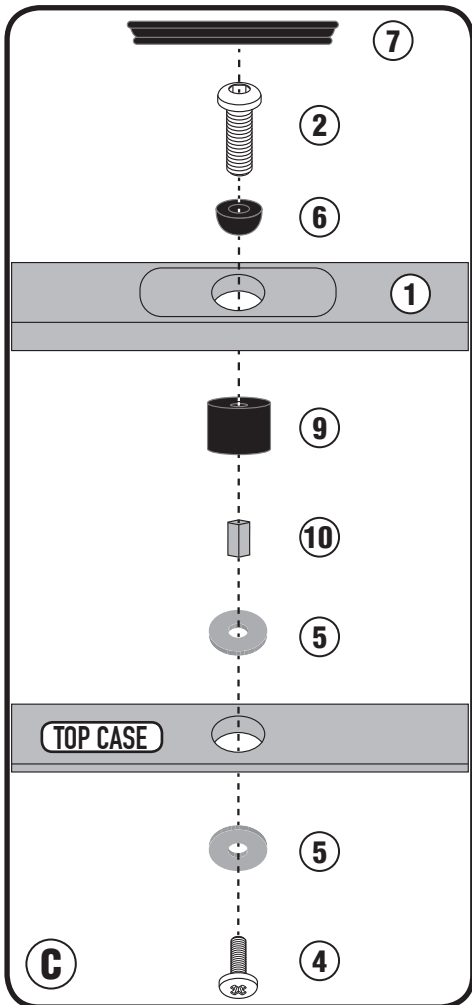
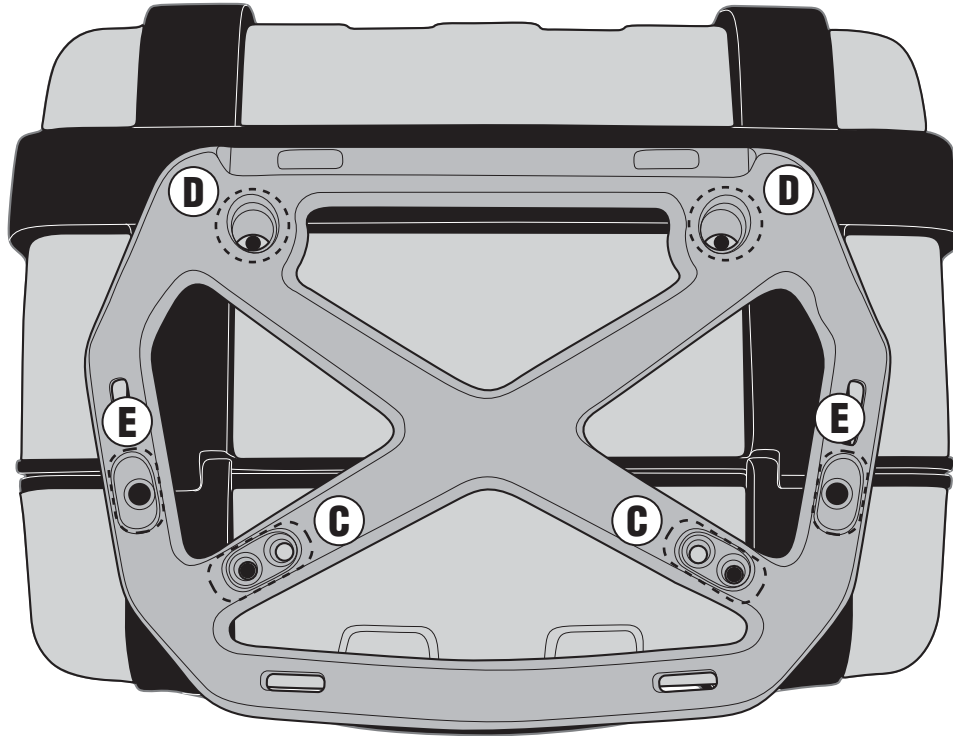

V47 - V56 MAXIA 4

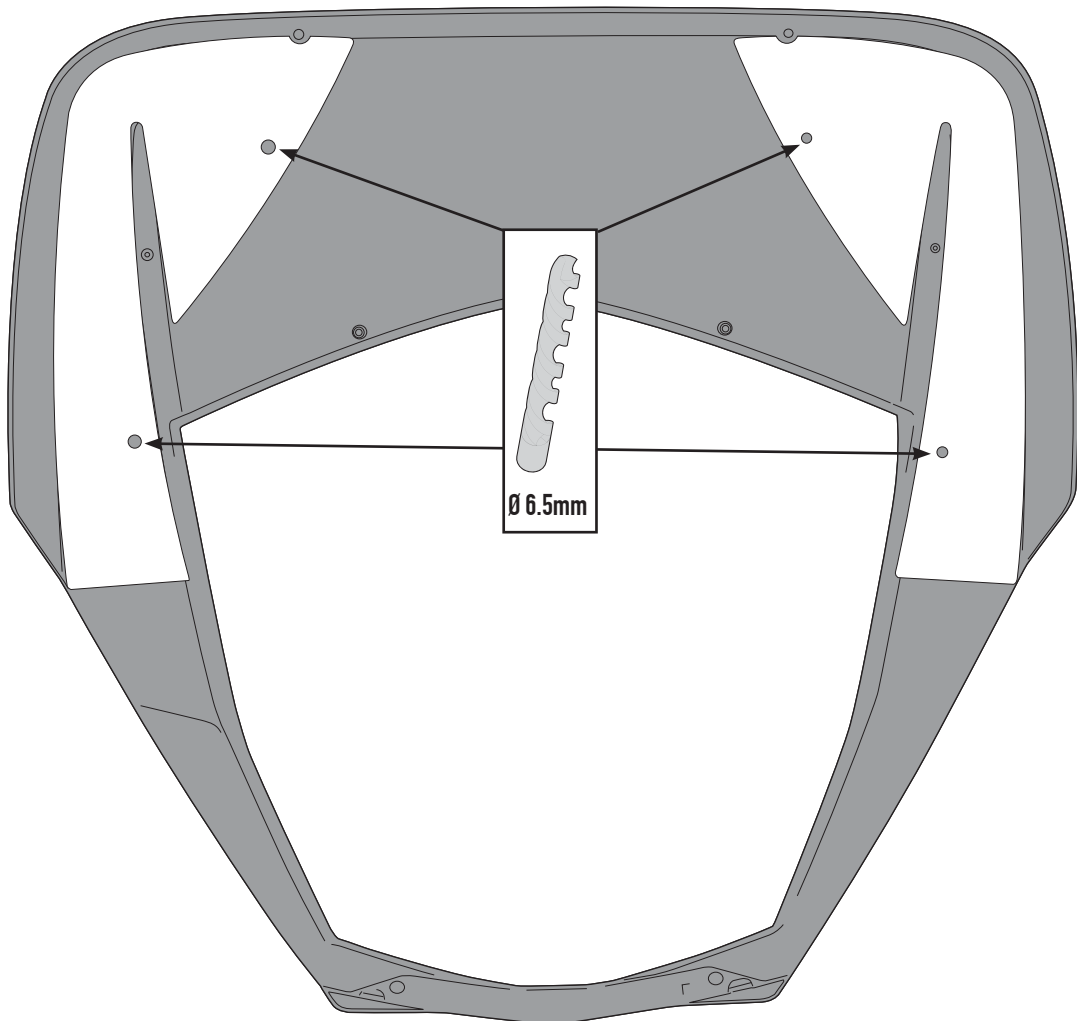
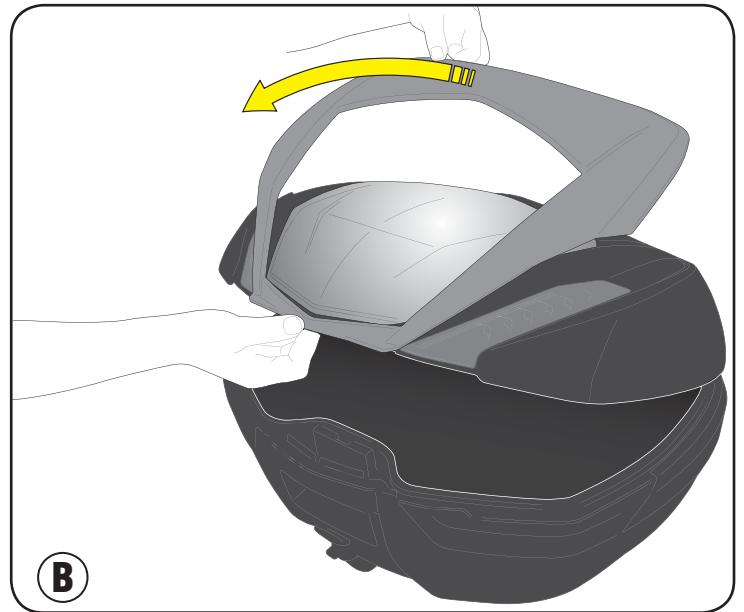
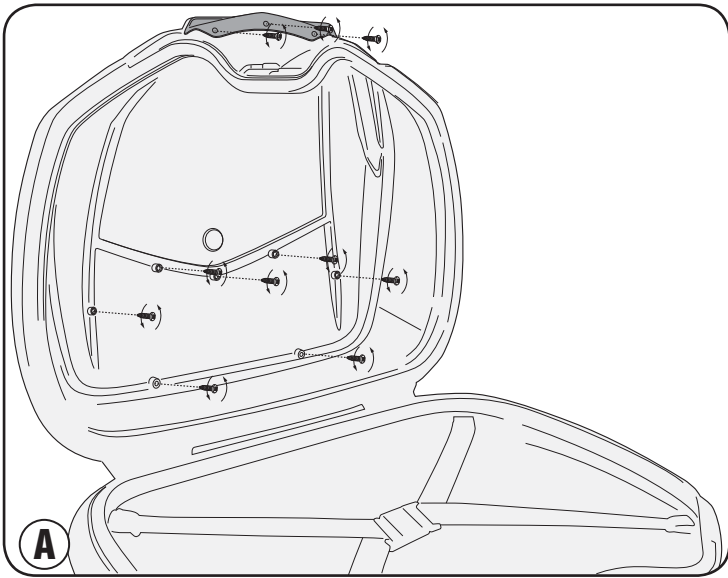

S150

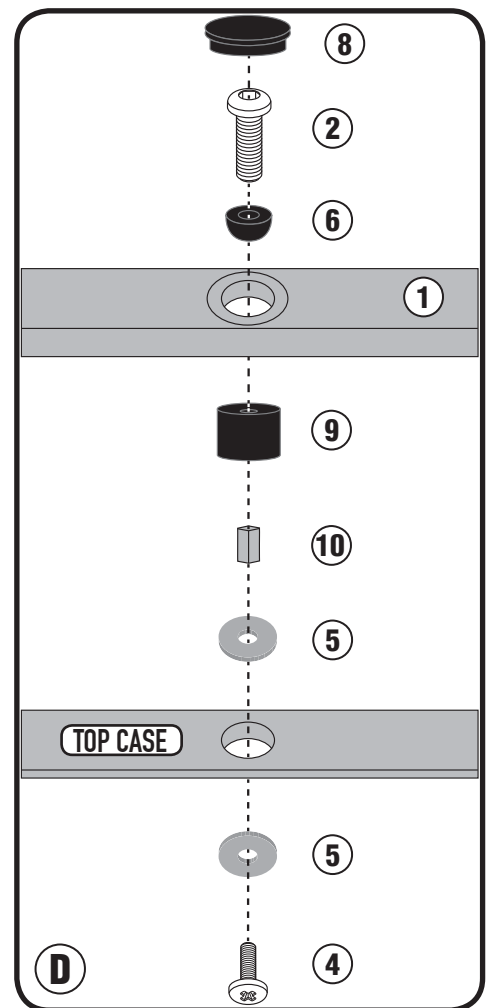
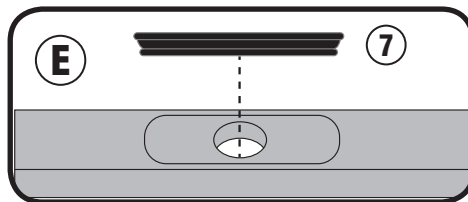
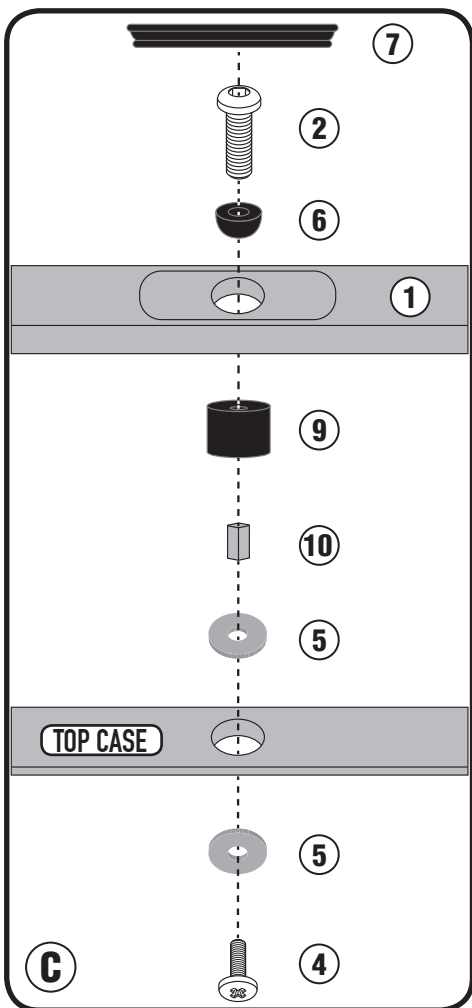
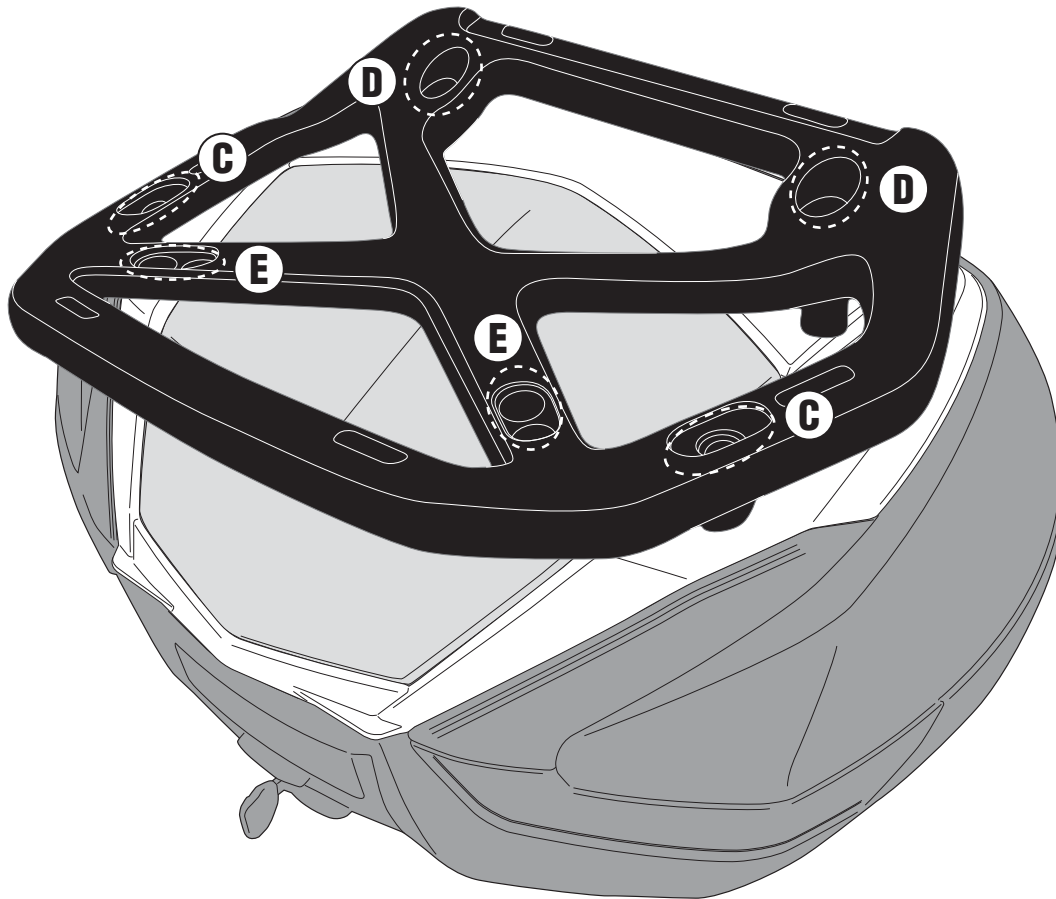

V47 - V56 MAXIA 4

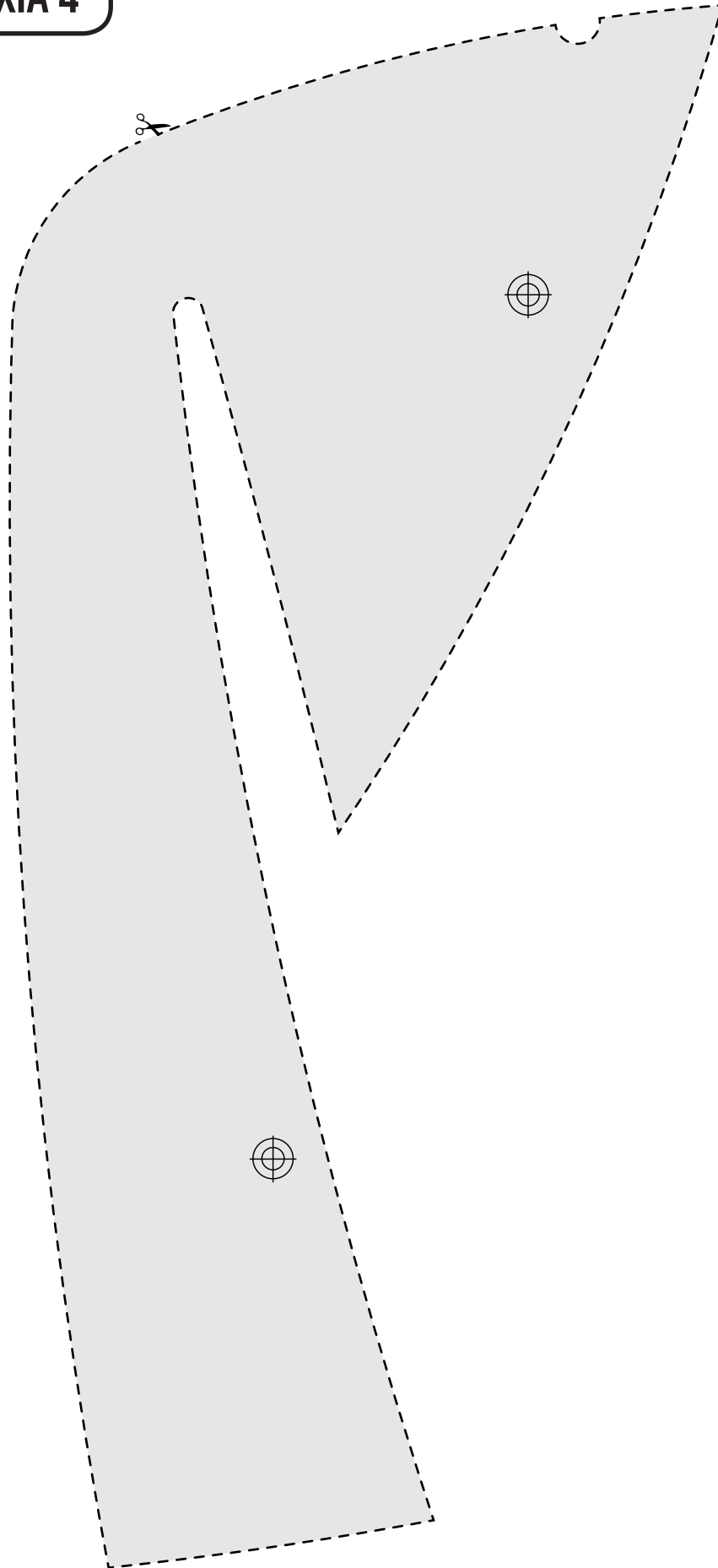

S150

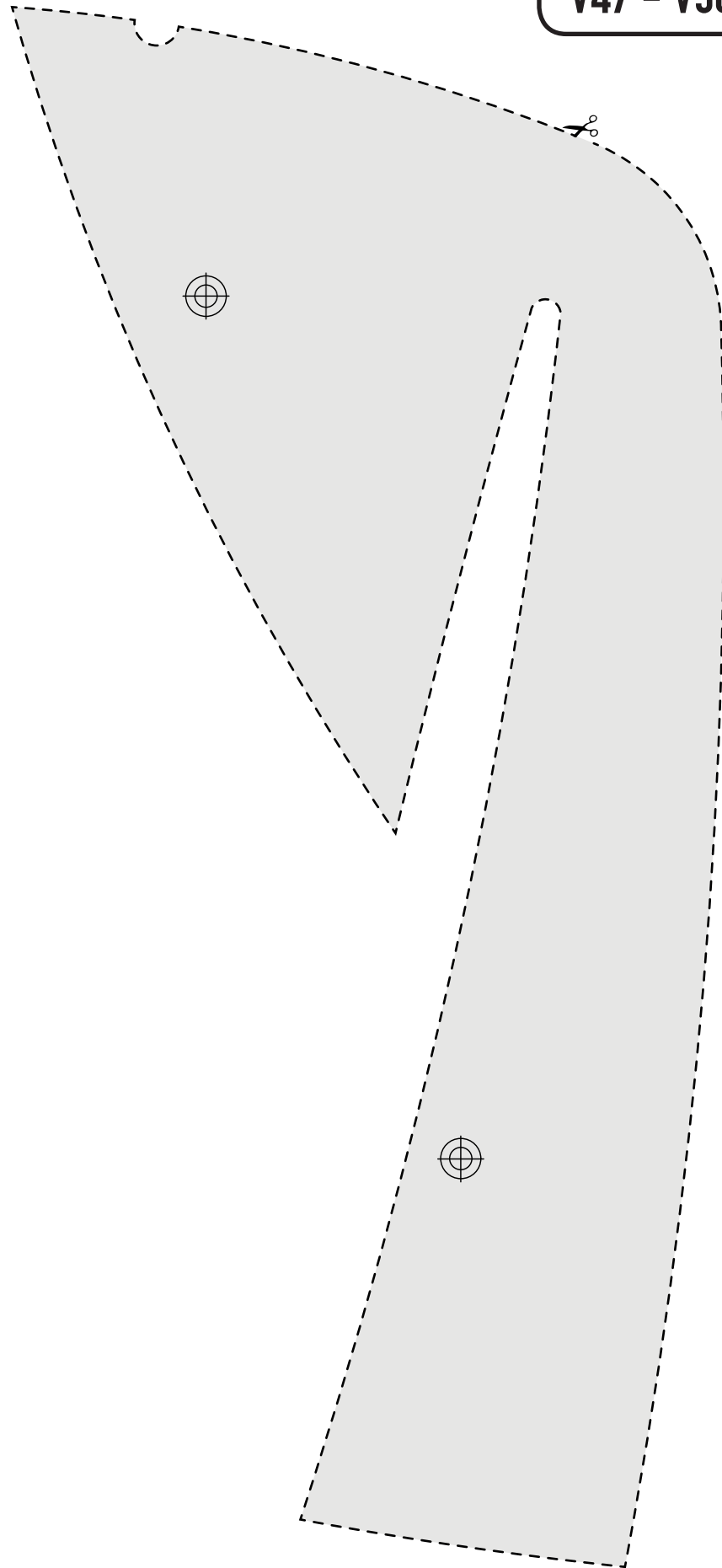

E55 MAXIA 3

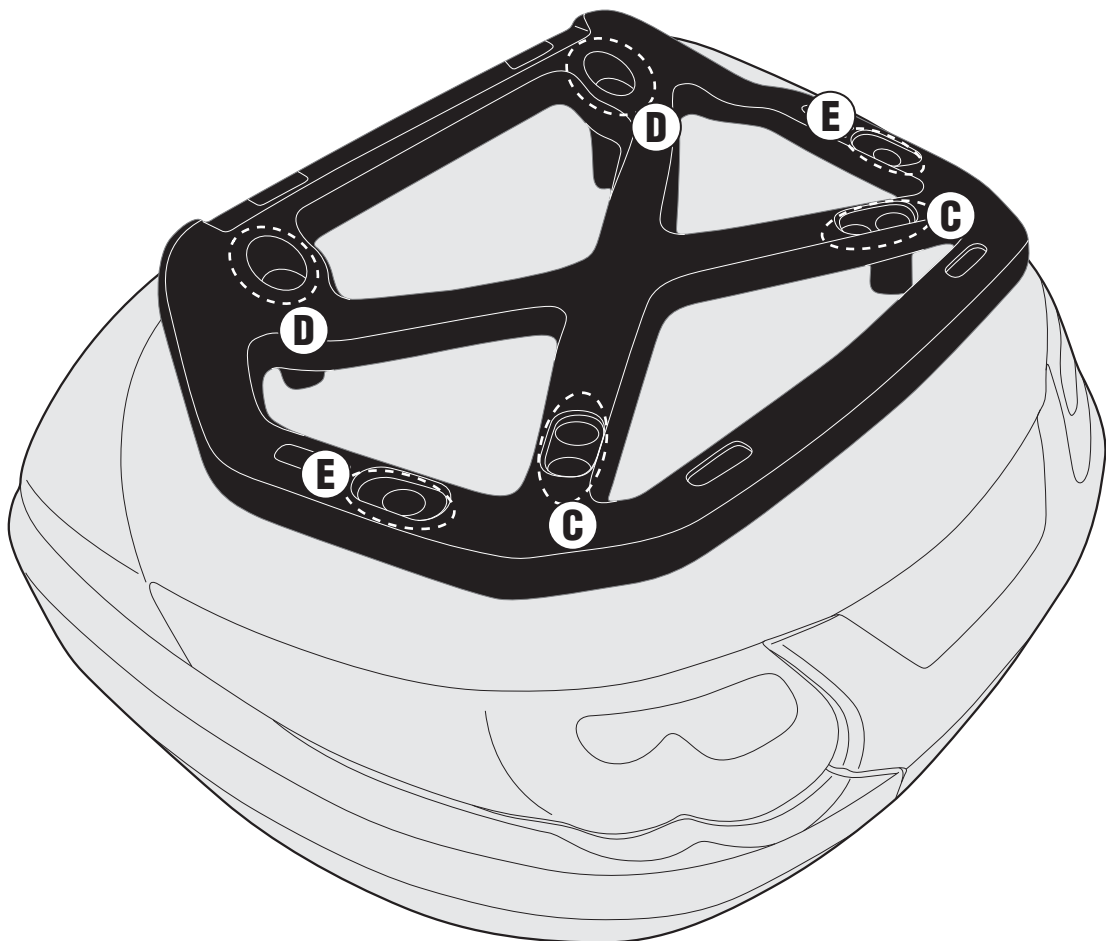
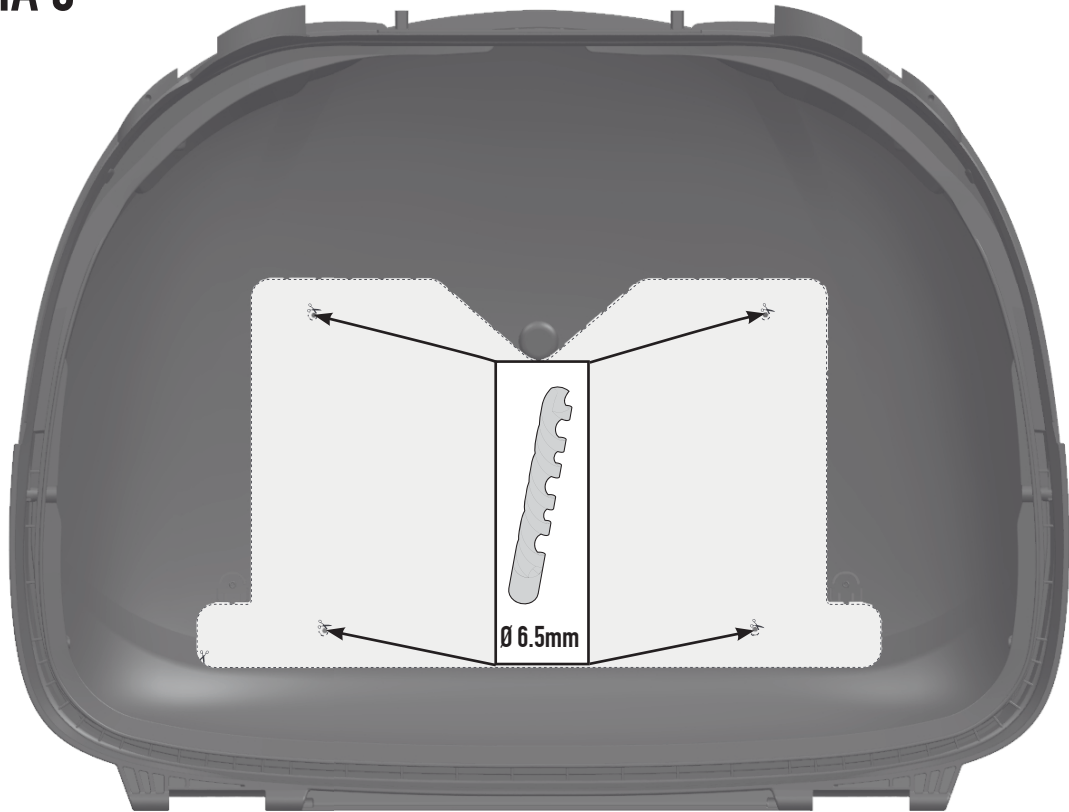

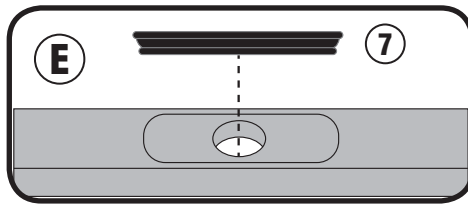
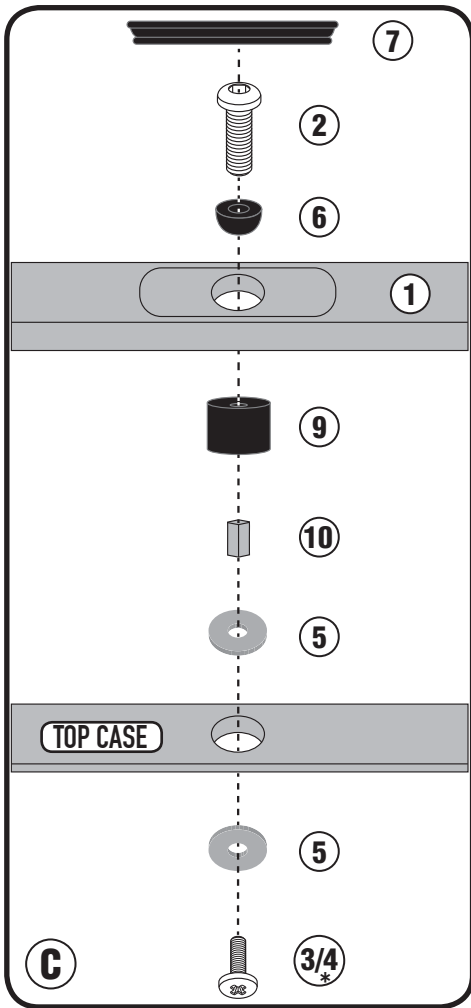

WITH COVER* (4)

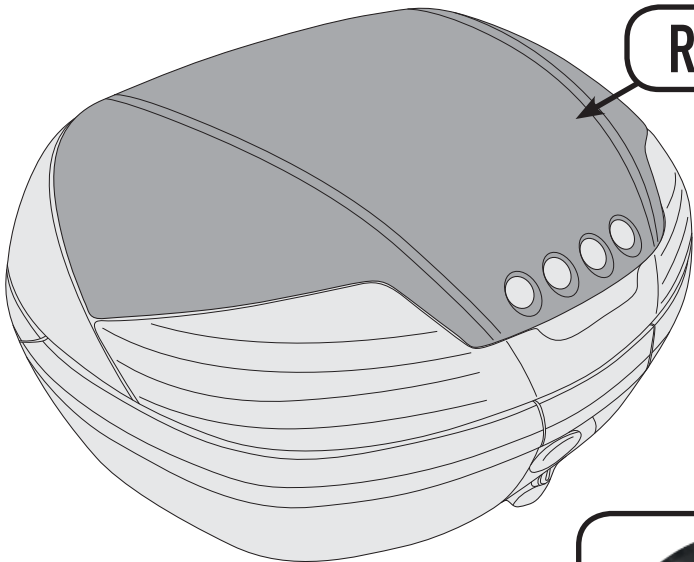
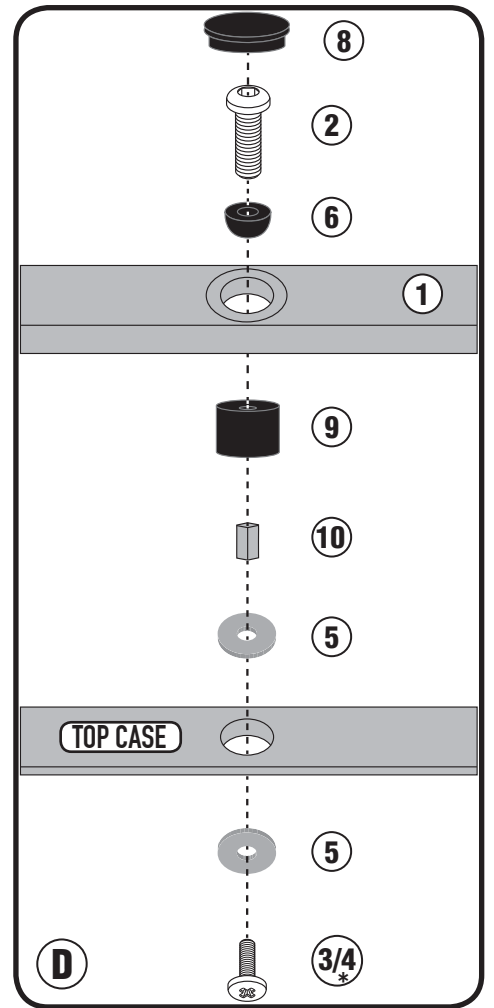

REMOVE

_V46

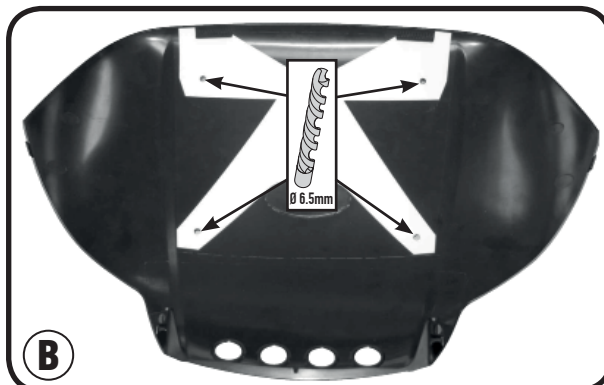
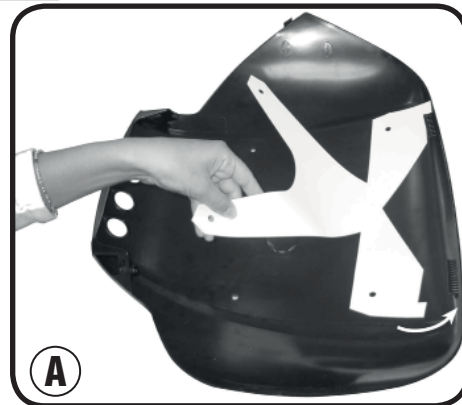

S150

