

PORTAVALIGIE LATERALE SPECIFICO - SPECIFIC TUBULAR SIDE-CASE HOLDER
 PORTE-VALISES LATÉRAUX SPÉCIFIQUE - SPEZIFISCHES STAHLROHR-SEITENTRÄGER
 PORTA MALETAS LATERALES ESPECIFICO

SUZUKI GSR600 2006

ISTRUZIONI DI MONTAGGIO - MOUNTING INSTRUCTIONS
 INSTRUCTIONS DE MONTAGE - BAUANLEITUNG - INSTRUCCIONES DE MONTAIE

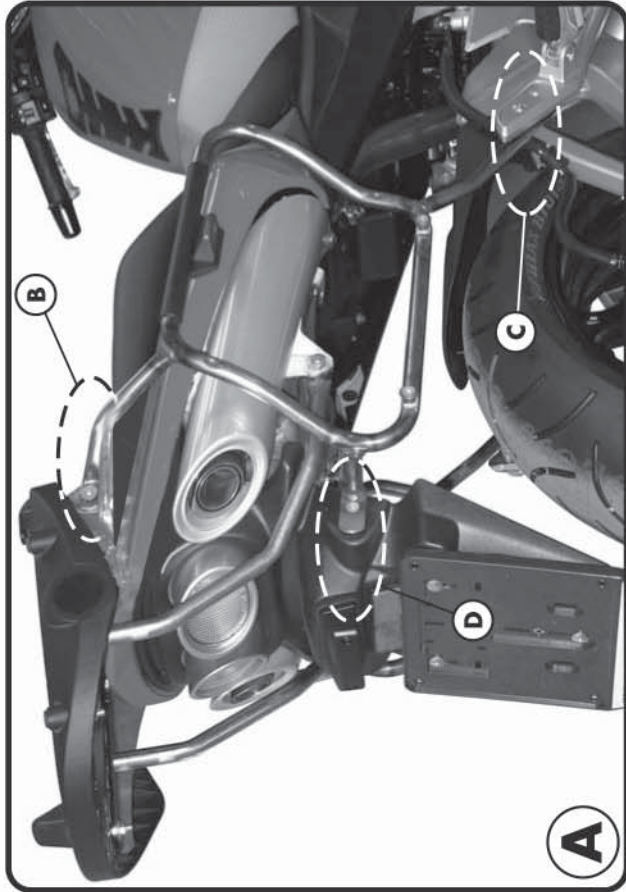

4  **Q.TY n.2**

VITE TBEI M6x25mm
 SCREW M6x25mm
 VIS M6x25mm
 SCHRAUBE M6x25mm
 TORNILLO M6x25mm

5  **Q.TY n.2**

VITE TBEI M6x45mm
 SCREW M6x45mm
 VIS M6x45mm
 SCHRAUBE M6x45mm
 TORNILLO M6x45mm

6  **Q.TY n.2**

RONDELLA ZIGRINATA Ø10
 WASHER
 RONDELLE
 SCHEIBE
 ARANDELA

7  **Q.TY n.2**

RONDELLA Ø6x18mm
 WASHER Ø6x18mm
 RONDELLE Ø6x18mm
 SCHEIBE Ø6x18mm
 ARANDELA Ø6x18mm

1  **Q.TY n.2 (Dx-Sx)**

SUPPORTO
 SUPPORT
 SUPPORT
 SÖFÖRTE

2 **PONTE POSTERIORE**
 REAR BRIDGE
 PONT POSTÉRIEURE
 VERBUNDUNGSGRÖHR
 PUENTE TRASERO
Q.TY n.1

3  **Q.TY n.2**

VITE TBEI M8x25mm
 SCREW M8x25mm
 VIS M8x25mm
 SCHRAUBE M8x25mm
 TORNILLO M8x25mm

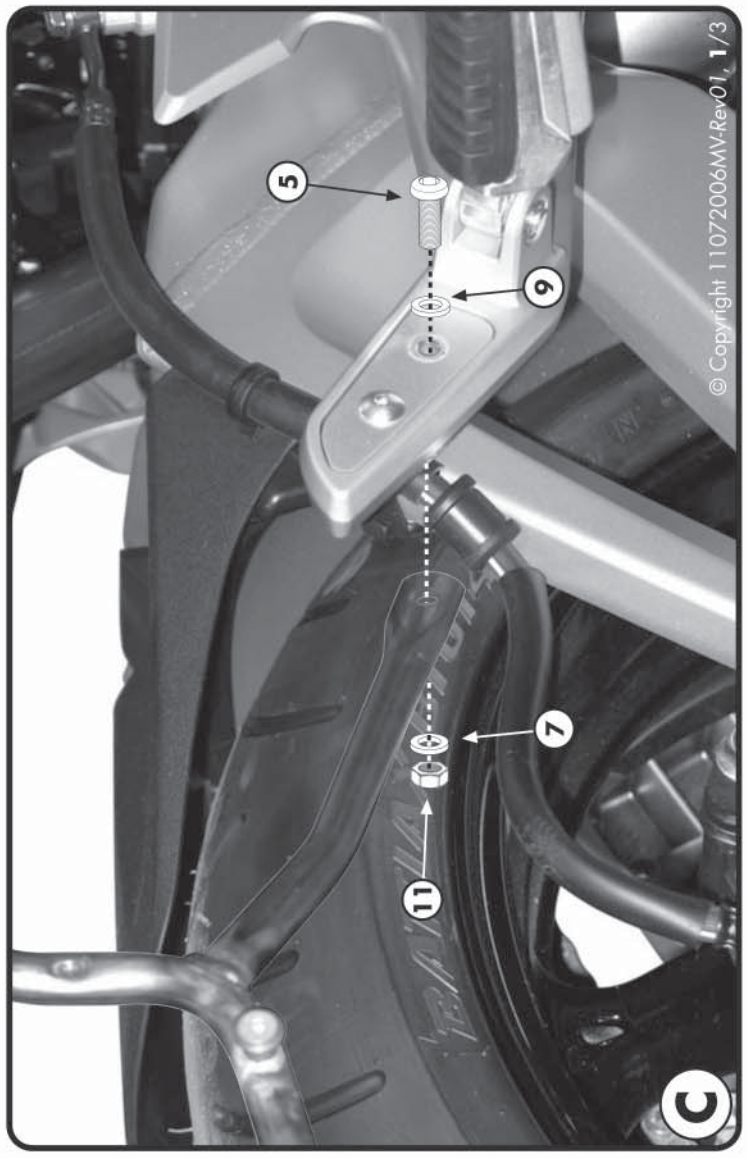
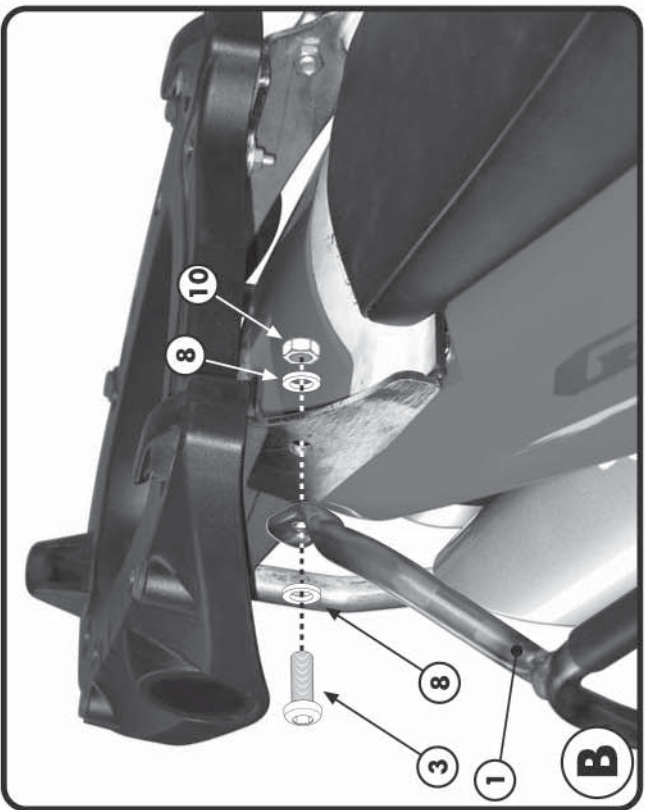

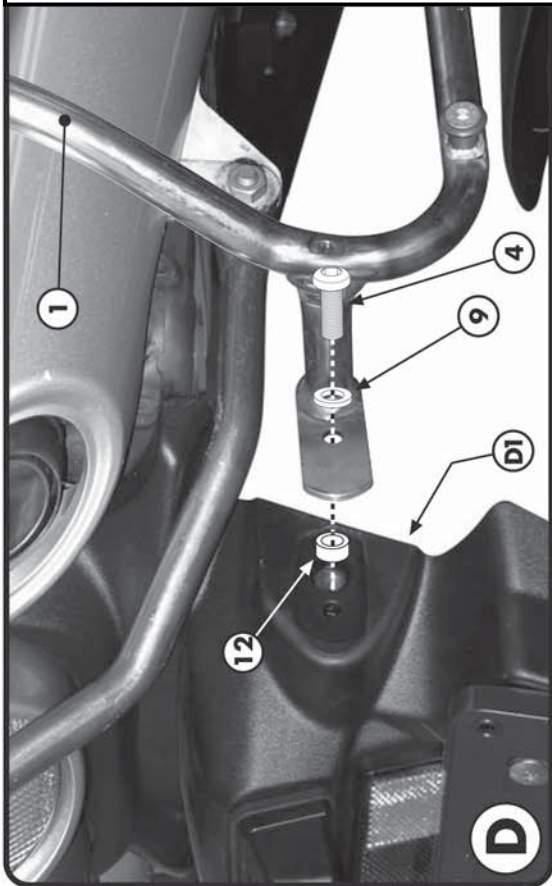

10  **DADO M8**
 ECROU M8
 MUTTER M8
 TUERCA M8

Q.TY n.2

11  **DADO A.B. M6**
 ECROU M6
 MUTTER M6
 TUERCA M6

Q.TY n.2

12  **DISTANZIALE Ø14x4mm**
 SPACER
 ENTRETOISE
 DISTANZSTÜCK
 DISTRANZDÖR

Q.TY n.2

13  **COMPONENTI ORIGINALI**
 ORIGINAL PARTS
 ORIGINALS
 ORIGINALBAUTEILE
 COMPONENTES ORIGINALES

Q.TY n.-

14  **SUPPORTO FRECCIA**
 BLINKER SUPPORT
 SUPPORT CLIGNOTANT
 BLINKER HALTER
 SOPORTE INTERMITENTE

Q.TY n.1

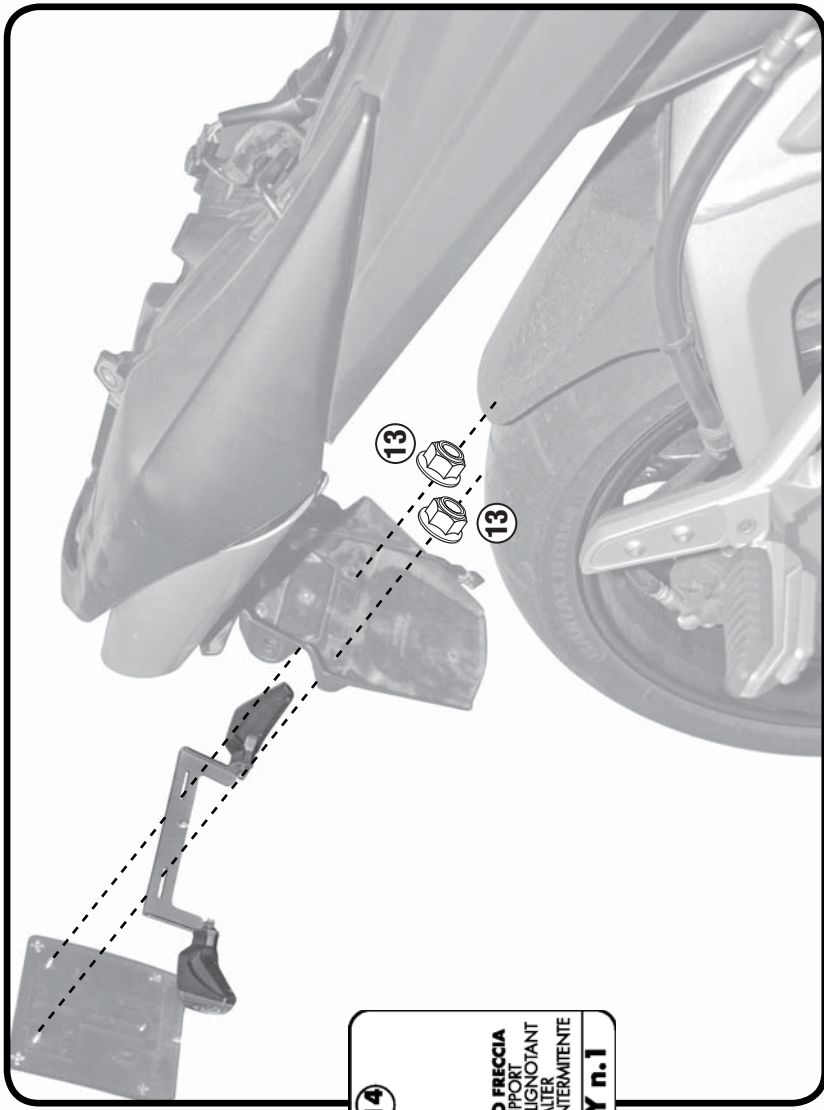

8  **RONDELLA Ø8mm**
 WASHER Ø8mm
 RONDELLE Ø8mm
 SCHEIBE Ø8mm
 ARANDELA Ø8mm

Q.TY n.4

9  **RONDELLA Ø6mm**
 WASHER Ø6mm
 RONDELLE Ø6mm
 SCHEIBE Ø6mm
 ARANDELA Ø6mm

Q.TY n.4

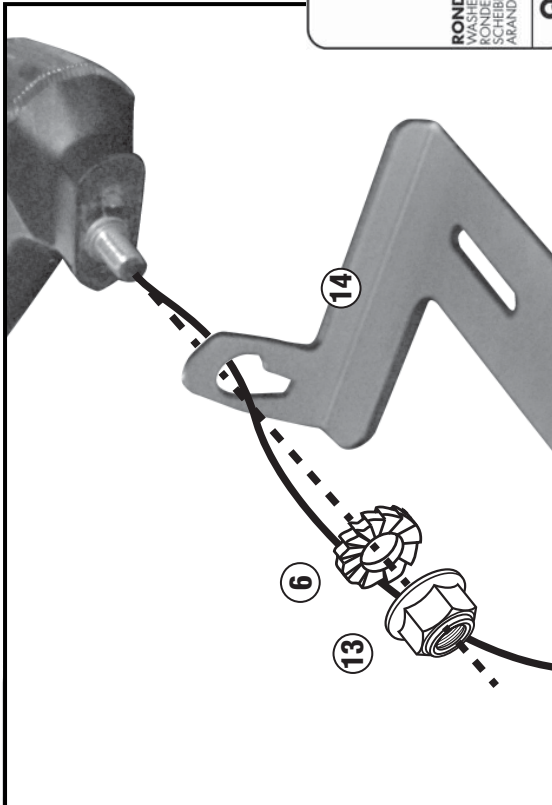

PORTAVALIGIE LATERALE SPECIFICO - SPECIFIC TUBULAR SIDE-CASE HOLDER
 PORTE-VALISES LATÉRAUX SPECIFIQUE - SPEZIFISCHES STAHLROHR-SEITENTRÄGER
 PORTA MALETAS LATERALES ESPECIFICO

SUZUKI GSR600 2006

ISTRUZIONI DI MONTAGGIO - MOUNTING INSTRUCTIONS
 INSTRUCCIONES DE MONTAJE - BAUANLEITUNG - INSTRUCCIONES DE MONTAJE

I ISTRUZIONI DI MONTAGGIO

1. MONTARE IL PORTAVALIGIE LATERALE COME ILLUSTRATO IN FOTOGRAFIA B, C E D.
2. NELL'ESEGUIRE IL MONTAGGIO ILLUSTRATO IN FOTOGRAFIA D FARE ATTENZIONE DI POSIZIONARE CORRETTAMENTE IL PARTICOLARE N°2 COME ILLUSTRATO IN FOTOGRAFIA D1.
3. INSTALLARE LE FRECCE SUI SUPPORTI N°14 COME INDICATO IN FOTOGRAFIA F E POI MONTARLI ALLA PIASTRA PORTAVALIGIA CENTRALE (NON INCLUSA) COME MOSTRATO IN FOTOGRAFIA E.
4. ULTIMARE IL MONTAGGIO CONTROLLANDO CHE TUTTE LE VITI SIANO SERRATE BENE.

GB MOUNTING INSTRUCTIONS

1. MOUNT THE SIDE-CASE HOLDER AS SHOWN IN THE PICTURES B, C AND D.
2. WHILE CARRYING OUT THE MOUNTING STEPS SHOWN IN PICTURE D MAKE SURE THAT YOU PLACE CORRECTLY ITEM N°2 AS SHOWN IN PICTURE D1.
3. INSTALL THE INDICATORS ON THE SUPPORTS N°14 AS SHOWN IN PICTURE F, THEN MOUNT THE REAR PLATE (NOT INCLUDED) AS SHOWN IN PICTURE E.
4. LASTLY CHECK THAT ALL SCREWS HAVE BEEN TIGHTENED.

F INSTRUCTIONS DE MONTAGE

1. MONTER LES SUPPORTS VALISES COMME ILLUSTRE EN PHOTO B, C ET D.
2. AU MONTAGE ILLUSTRE EN PHOTO D, FAIRE ATTENTION A POSITIONNER CORRECTEMENT LA PIECE N°2 COMME ILLUSTRE EN PHOTO D1.
3. INSTALLER LES CLIGNOTANTS SUR LES SUPPORTS N°14 COMME INDIQUE EN PHOTO F ET LES FIXER A LA PLATINE SUPPORT TOP CASE (NON INCLUSE) COMME MONTRE EN PHOTO E.
4. TERMINER LE MONTAGE EN CONTROLANT LE BON SERRAGE DE TOUTES LES VIS.

D BAUANLEITUNG

1. MONTIEREN SIE DEN SEITENKOFFERTRÄGER WIE IN DEN BILDERN B, C UND D BESCHRIEBEN;
2. BEI DER DURCHFÜHRUNG DER MONTAGESCHRITTE OM BILD D BEACHTEN SIE, DAS TEIL NR. 2 WIE IM BILD D1 KORREKT ZU POSITIONIEREN;
3. MONTIEREN SIE DIE BLINKER AUF DIE HALTERUNGEN NR. 14 WIE IM BILD F BESCHRIEBEN, DANN BEFESTIGEN SIE DIESE AN DIE TOPCASE-TRÄGERPLATTE (NICHT VORHANDEN) WIE IM BILD E BESCHRIEBEN.
4. ZULETZT ÜBERPRÜFEN SIE, DASS ALLE SCHRAUBEN FESTGEZOGEN WURDEN.

ES INSTRUCCIONES DE MONTAJE

1. MONTAR EL PORTAMALETAS LATERAL TAL Y COMO SE ILUSTR A EN LA FOTOGRAFÍA B, C Y D.
2. SEGUIR LAS INSTRUCCIONES DE MONTAJE ILUSTRADAS EN LA FOTOGRAFÍA D. PRESTAR ESPECIAL ATENCIÓN EN POSICIONAR CORRECTAMENTE, EN ESPECIAL, EL N°2, TAL Y COMO SE MUESTRA EN LA FOTOGRAFÍA D1.
3. INSTALAR EL SOPORTE DE INTERMITENTE N°14, TAL Y COMO SE INDICA EN LA FOTOGRAFÍA F Y POSTERIORMENTE, MONTAR LA PARRILLA PARA PODER INSTALAR LA MALETA TRASERA (NO INCLUIDA) TAL Y COMO SE MUESTRA EN LA FOTOGRAFÍA E.
4. ULTIMAR EL MONTAJE CONTROLANDO QUE TODOS LOS TORNILLOS ESTÉN BIEN APRETADOS.